

No. TD-6800 Series Ratchet Screwdriver



This functionally enhanced screwdriver enables screw tightening by simple repeated wrist movements.

Improved gear strength combined with our unique ratchet design makes these screwdrivers suitable for the most strenuous tightening jobs.

HAND TOOLS

BITS & SOCKETS

ELECTRIC TOOLS

AIR TOOLS

STATIC SOLUTIONS

GASOLINE ENGINE TOOLS



No. TD-6804MG Ratchet Screwdriver

Newly developed 72 gear ratchet realizes smooth rotation. You can work by one hand, without grasping over again.

Ratchet series optimal for a confined area

	Flexible	Plate Ratchet	Screw catcher	Stubby	Driver	Power
At a corner edge						
In a narrow area						
In a deep recessed area						
For torque retaining tightening						
	TD-6700FX-4	TD-74/75/76/77/78/79 TD-70/71/72	TD-73MC TX-12MC	TD-6700W-23	TD-6800 Series	S-13
						TD-80 S-12/13 TD-81R/81G/81B

No. TD-6804MG Ratchet Screwdriver (4-pc bit set) **NEW**

- Smoothly click feeling realized by rotating angle of 5° and 72 gears. High strength accomplished by 2 nails supporting the ratchet gear. It can be used for final tightening work.
- The handle is made out of oil-resistance cellulose acetate resin.
- Easy to carry around with cassette type bit storage inside the handle.
- Magnetic bits can be replaced with one-touch.
- Bit insertion part ●6.35mm.



Set content			
Body	length 177mm dia. 28.5mm		
Bits	⌀1, ⌀2, ⌀3, ⌀6 ×25.4mm		
Package size (mm)	Inner Ctn.	Outer Ctn.	EDP No.
235×80×29	5	30	247022

No. TD-6808MG Ratchet Screwdriver (8-pc bit set) **NEW**

- Smoothly click feeling realized by rotating angle of 5° and 72 gears. High strength accomplished by 2 nails supporting the ratchet gear. It can be used for final tightening work.
- The handle is made out of oil-resistance cellulose acetate resin.
- Easy to carry around with cassette type bit storage inside the handle.
- Stores 8 types of bits including HEX bit. Magnetic bits can be replaced with one-touch.
- Bit insertion part ●6.35mm.



Set content			
Body	length 177mm dia. 28.5mm		
Bits	⌀1, ⌀2, ⌀3, ⌀6, H2.5, H3, H4, H5 ×25.4mm		
Package size (mm)	Inner Ctn.	Outer Ctn.	EDP No.
235×80×29	5	30	247023

No. TD-6808TX Ratchet Screwdriver TORX (8-pc bit set) **NEW**

- Smoothly click feeling realized by rotating angle of 5° and 72 gears. High strength accomplished by 2 nails supporting the ratchet gear. It can be used for final tightening work.
- The handle is made out of oil-resistance cellulose acetate resin.
- Easy to carry around with cassette type bit storage inside the handle.
- Stores 8 types of bits including TORX bit. Magnetic bits can be replaced with one-touch.
- Bit insertion part ●6.35mm.



Set content			
Body	length 177mm dia. 28.5mm		
Bits	⌀2, ⌀3, T10H, T15H, T20H, T25H, T30H, T40H ×25.4mm		
Package size (mm)	Inner Ctn.	Outer Ctn.	EDP No.
235×80×29	5	30	247024

TORX® is a registered trademark of Acument TM Intellectual Properties, LLC (USA). VESSEL has a manufacturing license in Japan and selling same to the world.

No. TD-6816MG Ratchet Screwdriver (16-pc bit set) **NEW**

- Smoothly click feeling realized by rotating angle of 5° and 72 gears. High strength accomplished by 2 nails supporting the ratchet gear. It can be used for final tightening work.
- The handle is made out of oil-resistance cellulose acetate resin.
- Easy to carry around with cassette type bit storage inside the handle.
- 16 types of bits to adapt to various types of work. Magnetic bits can be replaced with one-touch.
- Bit insertion part ●6.35mm.



Set content			
Body	length 177mm dia. 28.5mm		
Bits	⌀1, ⌀2, ⌀3, ⌀6, H2, H2.5, H3, H4, H5, T10H, T15H, T20H, T25H, T27H, T30H, T40H ×25.4mm		
Package size (mm)	Inner Ctn.	Outer Ctn.	EDP No.
235×90×29	5	30	247025

TORX® is a registered trademark of Acument TM Intellectual Properties, LLC (USA). VESSEL has a manufacturing license in Japan and selling same to the world.

No. TD-6700W-23 Ratchet Stubby Screwdriver **NEW**

- Improves workability in cramped spaces! Stubby type that fits in your hand.
- Smoothly click feeling realized by rotating angle of 5° and 72 gears. High strength accomplished by 2 nails supporting the ratchet gear. It can be used for final tightening work.
- The handle is made out of oil-resistance cellulose acetate resin.
- Ball-lock bits can be replaced with one-touch.
- Bit insertion part ●6.35mm.



Set content			
Body	length 77mm	dia. 35mm	
Bits	⌀2 / ⌀3 × 35mm		
Package size (mm)	Inner Ctn.	Outer Ctn.	EDP No.
135×70×40	10	60	247026

No. TD-6700FX-4 Ratchet Stubby Screwdriver with Flexible Shaft **NEW**

- Improves workability in cramped spaces! Stubby type that fits in your hand.
- Smoothly click feeling realized by rotating angle of 5° and 72 gears. High strength accomplished by 2 nails supporting the ratchet gear. It can be used for final tightening work.
- The handle is made out of oil-resistance cellulose acetate resin.
- Ball-lock bits can be replaced with one-touch.
- Bit insertion part ●6.35mm.



Set content			
Body	length 77mm	dia. 35mm	
Bits	⌀1, ⌀2, ⌀4, ⌀6 × 33mm		
Flexible Shaft (length 165mm)			
Package size (mm)	Inner Ctn.	Outer Ctn.	EDP No.
235×80×40	5	30	247027

No. TD-81 Power Ratchet Screwdriver

- Ratchet fine feed enables to fasten with a little wrist movement.
- Ideal ratchet mechanism for sufficient final tightening.
- 2 double-ended bits (different size combination) can be stored within the handle.
- Bit insertion part ϕ 6.35mm

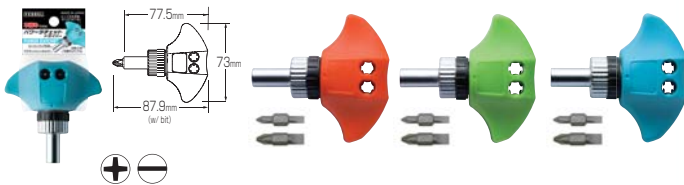

Model No.	Color	Bits	Package size (mm)	Inner Ctn.	EDP No.
TD-81R	Red	ϕ 1/ ϕ 4, ϕ 2/ ϕ 6 \times 25.4	115 \times 73 \times 34	10	250081
TD-81G	Green	ϕ 1/ ϕ 4, ϕ 2/ ϕ 6 \times 25.4	115 \times 73 \times 34	10	250082
TD-81B	Blue	ϕ 1/ ϕ 4, ϕ 2/ ϕ 6 \times 25.4	115 \times 73 \times 34	10	250083

No. TD-80 T-Bar Ratchet Screwdriver

- Ratchet driving mechanism allows you to tighten a screw without adjusting your grip.
- Bit insertion part ϕ 6.35mm



Set content

Body	T-bar ratchet screwdriver length 78mm dia. 73mm
Bits	ϕ 1, ϕ 2, ϕ 3, ϕ 4, ϕ 6 \times 25.4mm
Accessory	Bit belt holder

Package size (mm)	Outer Ctn.	EDP No.
170 \times 105 \times 28	40	250080



No. S-13 Handy Tool Set

- Easy-to-use tool sets for fastening jobs around the house.
- Optimum for work at a corner or place with obstacles!
- Bit insertion part ϕ 6.35mm

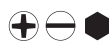

Set content

Body	T-bar ratchet screwdriver length 78mm dia. 73mm
Short Bits	ϕ 1, ϕ 2, ϕ 3, ϕ 4, ϕ 6, H2, H2.5, H3, H4, H5, H6 \times 25.4mm
Accessory	Magnetic Bit holder (length 115mm) Flexible shank (length 145mm)

Package size (mm)	Outer Ctn.	EDP No.
240 \times 143 \times 45	10	250003



No. 2200 Ball Ratchet Screwdriver NEW

- With 36-teeth gear ratchet to realize comfortable operation with fine tuning.
- Shank cover prevents short circuits. Thin shank is convenient for operating on terminal blocks.



- Shank uses bit materials, fully hardened. Replacement shank is available as option.



No.2200

						Inner Ctn.	Outer Ctn.	EDP No.	
\ominus 6 \times 100	6.0	0.8	100	6.0	41	200	6	60	125395
\ominus 6 \times 150	6.0	0.8	150	6.0	41	250	6	60	125396
\oplus 2 \times 100	ϕ No.2		100	6.0	41	200	6	60	125345
\oplus 2 \times 150	ϕ No.2		150	6.0	41	250	6	60	125346
\oplus 3 \times 150	ϕ No.3		150	6.0	41	250	6	60	125347

⚠ Electric insulation is not guaranteed. For safety purposes, shut off power before use.

No. 2200B Ball Ratchet Screwdriver Reversible Blade NEW

- Shank uses bit materials, fully hardened.
- Replacement blade; can be replaced by pulling out the ball-grip part of No.2200.



No.2200B

						Inner Ctn.	Outer Ctn.	EDP No.
\ominus 6 \times 100	6.0	0.8	100	6.0	158	6	60	125397
\ominus 6 \times 150	6.0	0.8	150	6.0	208	6	60	125398
\oplus 2 \times 100	ϕ No.2		100	6.0	158	6	60	125348
\oplus 2 \times 150	ϕ No.2		150	6.0	208	6	60	125349
\oplus 3 \times 150	ϕ No.3		150	6.0	208	6	60	125350

One point

Shanks are detachable from the ratchet part

Reversible blade can be replaced with one-touch.

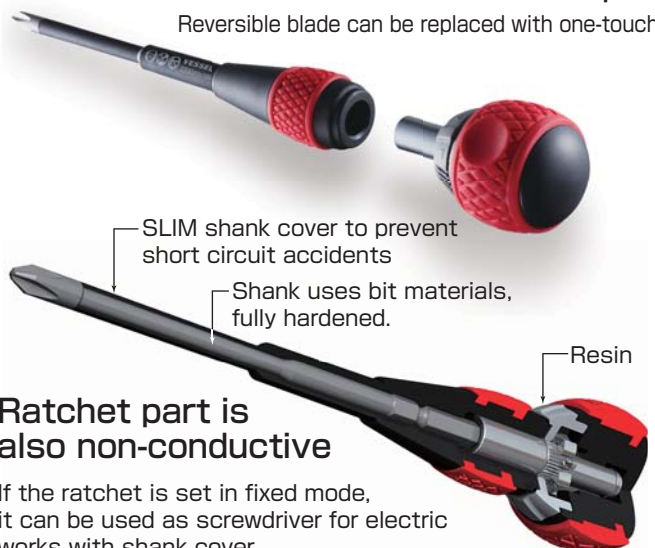

Ratchet part is also non-conductive

If the ratchet is set in fixed mode, it can be used as screwdriver for electric works with shank cover. It is most suitable for working on distribution boards.

HAND TOOLS

BITS & SOCKETS

ELECTRIC TOOLS

AIR TOOLS

STATIC SOLUTIONS

GASOLINE ENGINE TOOLS

No. TD-74 "PETA-RACHE" Flat-shaped Ratchet Screwdriver (straight type)

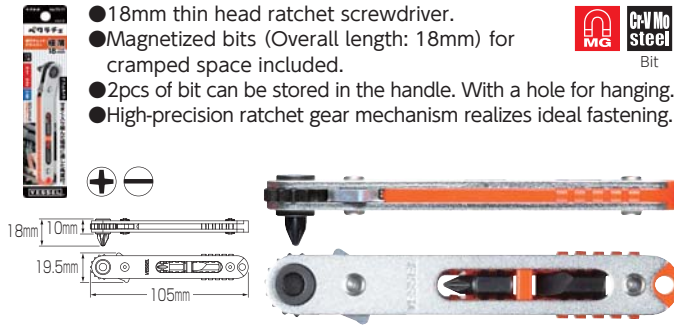

Model No.	Set content	Package size (mm)	Inner Ctn.	EDP No.
TD-74	Flat-shaped Ratchet Screwdriver (Straight type) Bits $\oplus 1$, $\oplus 2$, $\ominus 6 \times 18\text{mm}$	160x35x21	10	250074

No. TD-77 "PETA-RACHE" Flat-shaped Ratchet Screwdriver (bent-up type)

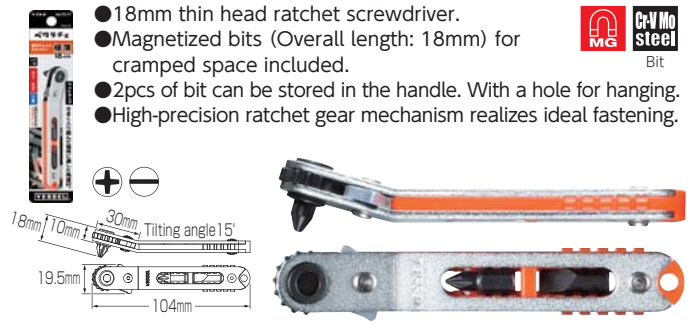

Model No.	Set content	Package size (mm)	Inner Ctn.	EDP No.
TD-77	Flat-shaped Ratchet Screwdriver (Angled type) Bits $\oplus 1$, $\oplus 2$, $\ominus 6 \times 18\text{mm}$	160x35x21	10	250077

No. TD-75 "PETA-RACHE" Flat-shaped Ratchet Screwdriver (straight type)

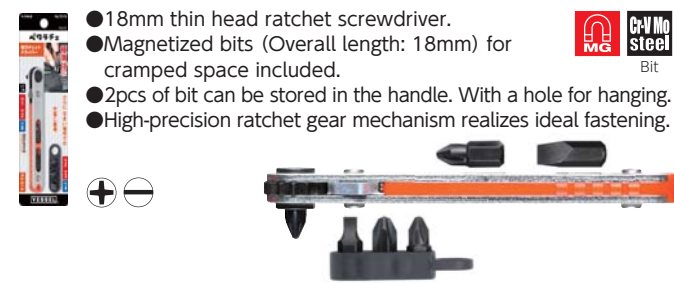

Model No.	Set content	Package size (mm)	Inner Ctn.	EDP No.
TD-75	Flat-shaped Ratchet Screwdriver (Straight type) Bits $\oplus 1$, $\oplus 2$, $\oplus 2$, $\oplus 3$, $\ominus 4$, $\ominus 6 \times 18\text{mm}$ Bit holder	160x50x21	10	250075

No. TD-78 "PETA-RACHE" Flat-shaped Ratchet Screwdriver (bent-up type)



Model No.	Set content	Package size (mm)	Inner Ctn.	EDP No.
TD-78	Flat-shaped Ratchet Screwdriver (Angled type) Bits $\oplus 1$, $\oplus 2$, $\oplus 2$, $\oplus 3$, $\ominus 4$, $\ominus 6 \times 18\text{mm}$ Bit holder	160x50x21	10	250078

No. TD-76 "PETA-RACHE" Flat-shaped Ratchet Screwdriver (straight type)



Model No.	Set content	Package size (mm)	Inner Ctn.	EDP No.
TD-76	Flat-shaped Ratchet Screwdriver (Straight type) Bits $\oplus 1$, $\oplus 2$, $\oplus 2$, $\oplus 3$, $\ominus 4$, $\ominus 6$, H2.5, H3, H4, H5, H6x18mm Bit holder	160x50x21	10	250076

No. TD-79 "PETA-RACHE" Flat-shaped Ratchet Screwdriver (bent-up type)



Model No.	Set content	Package size (mm)	Inner Ctn.	EDP No.
TD-79	Flat-shaped Ratchet Screwdriver (Angled type) Bits $\oplus 1$, $\oplus 2$, $\oplus 2$, $\oplus 3$, $\ominus 4$, $\ominus 6$, H2.5, H3, H4, H5, H6x18mm Bit holder	160x50x21	10	250079

No. TD-BS "PETA-RACHE" 18mm replacement bits

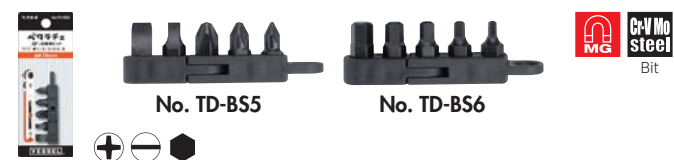

Model No.	Set content	Package size (mm)	Inner Ctn.	EDP No.
TD-BS5	Bits $\oplus 1$, $\oplus 2$, $\oplus 3$, $\ominus 4$, $\ominus 6 \times 18\text{mm}$ Bit holder	120x40x23	10	251304
TD-BS6	Bits H2.5, H3, H4, H5, H6x18mm Bit holder	120x40x23	10	251305

No. TD-70 Flat Plate Ratchet Screwdriver Set



Set content		Package size (mm)	Inner Ctn.	EDP No.
Body	Plate ratchet screwdriver			
Bits	Φ1, Φ2, Φ3, Φ4, Φ6, H2.5, H3, H4, H5, H6×25.4mm			
Accessory	Bit belt holder			

No. TD-73MC Plate Ratchet Screw Catcher

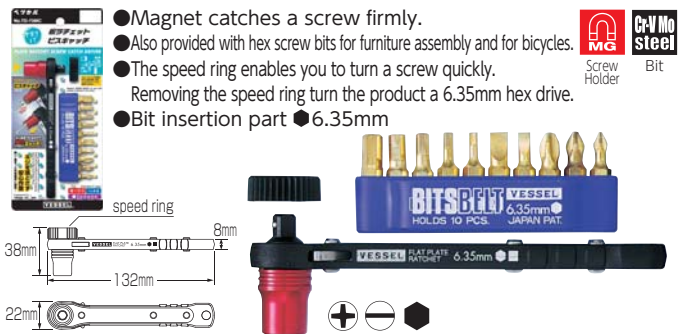

Set content		Package size (mm)	Inner Ctn.	EDP No.
Body	Plate ratchet screwdriver			
Bits	Φ1, Φ2, Φ3, Φ4, Φ6, H 2.5, 3, 4, 5, 6×25.4mm			
Accessory	Magnetic Screw Holder Bit belt holder			

No. TD-71 Flat Plate Ratchet Screwdriver

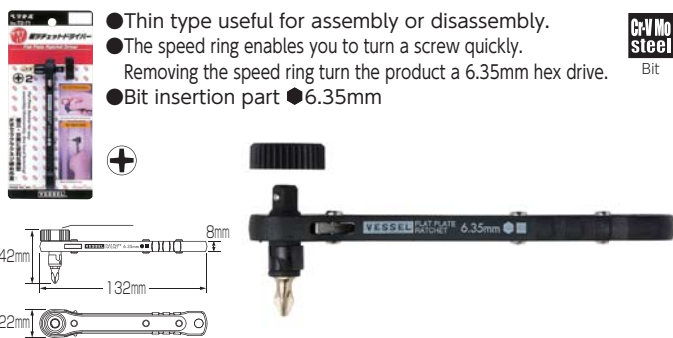

Set content		Package size (mm)	Inner Ctn.	EDP No.
Body	Plate ratchet screwdriver			
Bit	Φ2×25.4mm			

No. TX-12MC Plate Ratchet/Magnetic Screw Catcher (TORX)

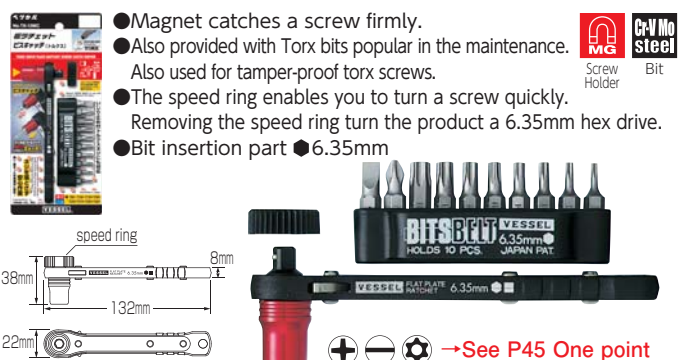

Set content		Package size (mm)	Inner Ctn.	EDP No.
Body	Plate ratchet screwdriver			
Bits	T8H, T10H, T15H, T20H, T25H, T27H, T30H, T40H, Φ2, Φ6×25.4mm			
Accessory	Magnetic Screw Holder Bit belt holder			

No. TD-72 Flat Plate Ratchet Screwdriver Set

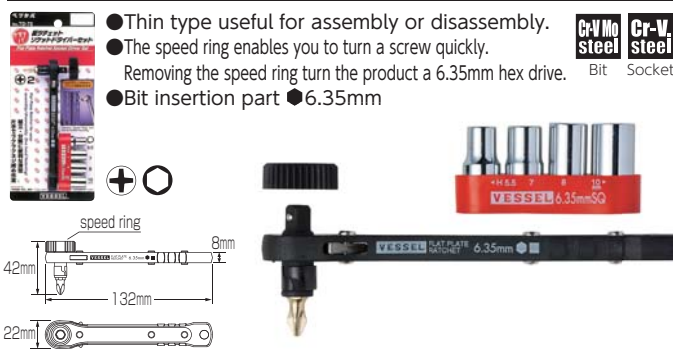

Set content		Package size (mm)	Inner Ctn.	EDP No.
Body	Plate ratchet screwdriver			
Bit	Φ2×25.4mm			
Socket	A/F 5.5, 7, 8, 10×26mm			
Accessory	Socket holder			

No. TX-11 Plate Ratchet TORX Set

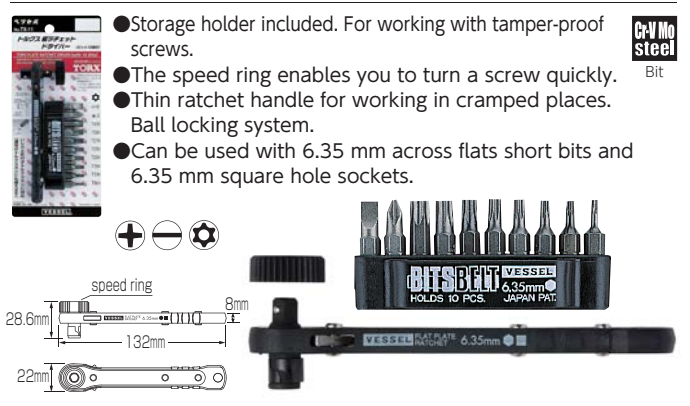





Set content		Package size (mm)	Inner Ctn.	EDP No.
Body	Plate ratchet screwdriver			
Bits	T8H, T10H, T15H, T20H, T25H, T27H, T30H, T40H, Φ2, Φ6×25.4mm			
Accessory	Magnetic Screw Holder Bit belt holder			

TORX® is a registered trademark of Acument TM Intellectual Properties, LLC (USA). VESSEL has a manufacturing license in Japan and selling same to the world.

HAND TOOLS
 BITS & SOCKETS
 ELECTRIC TOOLS
 AIR TOOLS
 STATIC SOLUTIONS
 GASOLINE ENGINE TOOLS

No. TD-BS Replacement Bit Set



No. TD-BS1  **No. TD-BS2**  **No. TD-BS3** 

Applicable models
TD-70/TD-71/TD-72/TD-73MC/TD-80/TD-150/TD-160/S-12/S-13
TX-10/TX-11/TX-12MC/830MG-4/840/840L

Applicable models
TD-70/TD-71/TD-72
TD-170
TX-11/TD-73MC
TX-12MC

No. TD-BS4 

Cr-V Mo steel Bit
Cr-V steel Socket

Model No.	Set content	Package size (mm)	Inner Ctn.	EDP No.
TD-BS1	⊕1, ⊕2, ⊕3, ⊖4, ⊖6 ×25.4mm Bit belt holder	120×45×23	10	251300
TD-BS2	H 2.5, 3, 4, 5, 6 ×25.4mm Bit belt holder	120×45×23	10	251301
TD-BS3	T10H, T15H, T20H, T25H, T30H ×25.4mm Bit belt holder	120×45×23	10	251302
TD-BS4	A/F 5.5, 7, 8, 10 Socket holder	120×45×23	10	251303

TORX® is a registered trademark of Acument TM Intellectual Properties, LLC (USA). VESSEL has a manufacturing license in Japan and selling same to the world.

No. TD-64 "PETADORA" Z-shaped Offset Screwdriver



- S-shaped type good for strong tightening in cramped spaces.
- Special plating to keep precision at the tip.

No. TD-64

	⊕2/⊖6	⊕1/⊕2
Tip (mm)	6 0.9 / ⊕No.2 18 6 129	⊕No.1 / ⊕No.2 16.5 5 126
Inner Ctn.	10	10
Outer Ctn.	100	100
EDP No.	250122	250121

Package size...160×35×12mm

No. 25 Offset Screwdriver



- S-shaped type good for strong tightening in cramped spaces.
- Different size tips combined.

Can be chosen according to applications.

No. 25

	⊕1/⊖5	⊕2/⊖6	⊕3/⊖8
Tip (mm)	25 5 125	26 6 125	33 8 150
Inner Ctn.	12	12	12
EDP No.	143005	143006	143007

Package size...160×35×12mm

No. 251526 2-Piece Offset Screwdriver Set

Model No.	Set content	Package size (mm)	Inner Ctn.	EDP No.
251526	No.25 ⊖6/⊕2, ⊖5/⊕1	210×70×10	20	243011

No. TD-61 "PETADORA" L-shaped Offset Screwdriver



- Special plating to keep precision at the tip.
- L-shaped type good for working in cramped spaces.

No. TD-61

	⊖6	⊕1	⊕2
Tip (mm)	6 0.9 18 6 117	⊕No.1 16.5 5 105	⊕No.2 18 6 117
Cushion Grip color	Blue	Green	Red
Inner Ctn.	10	10	10
Outer Ctn.	100	100	100
EDP No.	250105	250101	250102

Package size...160×35×14mm

No. TD-63 "PETADORA" L-shaped Offset Screwdriver



- Special plating to keep precision at the tip.
- L-shaped type good for working in cramped spaces.

No. TD-63

	H 2.5	H 3	H 4	H 5
Tip (mm)	2.5 16.5 5 105	3 16.5 5 105	4 16.5 5 105	5 18 6 117
Cushion Grip color	Orange	Purple	Black	Blue
Inner Ctn.	10	10	10	10
Outer Ctn.	100	100	100	100
EDP No.	250112	250113	250114	250115

Package size...160×35×14mm

One point

Speedy fast-turning,
firm tightening

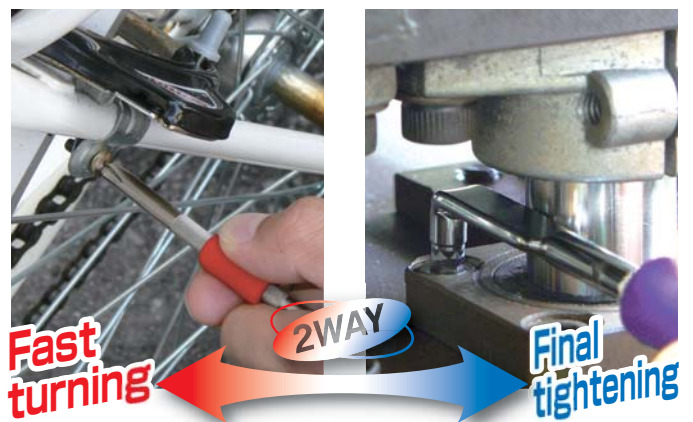

*This one product can be used
from fast-turning to tightening!*

An evolution of offset screwdriver with all the required functions for tightening screws.

No. 83L LED Voltage Detection Screwdriver

- For conduction/ continuity test in general household.
- Long-life LED lights brightly. Batteries can be replaced.
- Handy pencil-type screwdriver.



Voltage detection range	4.0	0.45	20	17.5	130	Package size (mm)	Inner Ctn.	EDP No.
100 to 250V AC						185×70×16	10	125106

One point

Conductivity check of electrical wiring tools

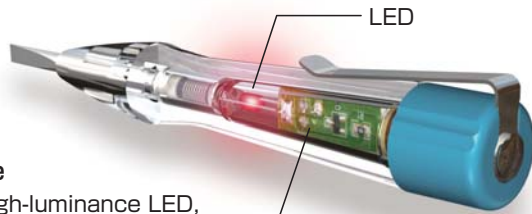

LED type

Uses a high-luminance LED, allowing you to check electrical conductivity easily even in a bright location. Batteries are consumables and need to be replaced.

Conductivity check / polarity discrimination Continuity test

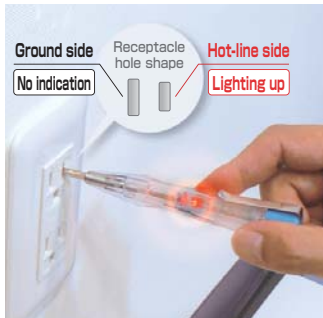

A conductivity check of electrical wiring or receptacle and polarity discrimination of AC hot-line and ground sides



Continuity check of a wiring circuit. Make sure that no power is applied to the circuit before checking continuity.

No. TD-1300L

6-Piece Voltage Detection Screwdriver Set NEW

- Neon tube integrated into the grip end. When contacting the current-carrying point, the neon tube lights and continuity test can be conducted. **Cr-V. steel**
- Resin chuck enables to replace the blades. Lightweight resin grip, with a transparent end-cap at the grip edge.
- Frequently used 6 types of blade in a pack.
- Provided in a handy transparent vinyl carrying and storage pouch.
- Low voltage type (100 to 250V AC)



No. TD-1300L

Voltage detection range	Reversible blade content (mm)				Inner Ctn.	EDP No.
	⊖	⊕	Awl	Pin extractor		
100 to 250V AC	⊖4×125 ⊖6×125	⊕1×125 ⊕2×125	125	125	10	247021
Handle length 126.4mm dia. 26.5mm						

※Package size...185×105×31mm

No. TD-1300B

5-Piece Voltage Detection Screwdriver Set NEW

- Neon tube integrated into the grip end. When contacting the current-carrying point, the neon tube lights and continuity test can be conducted. **Cr-V. steel** Except Socket
- Resin chuck enables to replace the blades. Lightweight resin grip, with a transparent end-cap at the grip edge.
- A small diameter type socket suitable for small screws included in replacement blade set.
- Handy vinyl carrying and storage pouch
- Low voltage type (100 to 250V AC)



No. TD-1300B

Voltage detection range	Reversible blade content (mm)				Inner Ctn.	EDP No.
	⊖	⊕	Socket			
100 to 250V AC	⊖4×125	⊕1×125 ⊕2×125	A/F5	×125 A/F5.5×125	10	247031
Handle length 126.4mm dia. 26.5mm						

※Package size...185×105×31mm

HAND TOOLS

BITS & SOCKETS

ELECTRIC TOOLS

AIR TOOLS

STATIC SOLUTIONS

GASOLINE ENGINE TOOLS

No. 240001 Impact Driver

- One-touch switching of the rotation direction.
- Soft non-slip resin handle, comfortable to grip. Designed for less shock on hands.
- For heavy-duty use.
- If the bit adapter is detached, a 12.7 mm socket can be attached.
- Bit insertion part ●8mm



Set content		Package size (mm)	Outer Ctn.	EDP No.
Bits	⌀2×36, ⌀2×80, ⌀3×36, ⌀3×80, ⌀4×36, ⌀10×36			
Body	length 176mm dia. 37.5mm	220×73×80	5	246051

No. 250001 Impact Driver

- Effective for very tight fastening and loosening rusted screws.
- Suited for automobile maintenance, and assembly and disassembly of machinery and equipment.
- For heavy-duty use.
- If the bit adapter is detached, a 12.7 mm socket can be attached.
- Bit insertion part ●8mm



Set content		Package size (mm)	Outer Ctn.	EDP No.
Bits	⌀10, ⌀2, ⌀3, ⌀4×36			
Body	length 166mm dia. 32mm	325×80×38	5	246001

No. 260002 Impact Uni Driver

- Thin handle. Can be used as normal screwdriver.
- Long shank bit. Ideal for hard-to-reach cramped spaces.
- Bit insertion part ●6.35mm



Set content		Package size (mm)	Outer Ctn.	EDP No.
Bits	⌀5, ⌀6, ⌀7, ⌀1, ⌀2, ⌀3×125			
Body	length 132.5mm dia. 26mm	225×110×33	5	246016

No. C50/C51 Impact Driver Bit

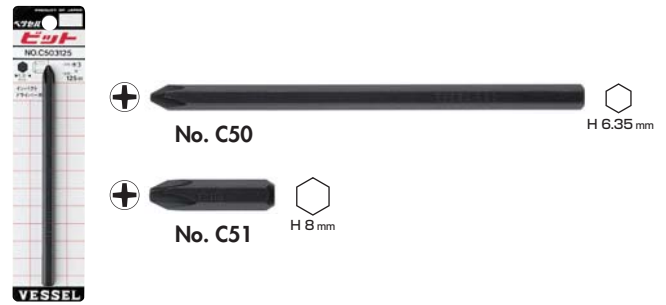

Model No.	Set content	Applicable models	Package size (mm)	Inner Ctn.	EDP No.
C502125	⌀2×125	260002	170×42	10	486212
C503125	⌀3×125	260002	170×42	10	486213
C506125	⌀6×125	260002	170×42	10	486216
C512036	⌀2×36	250001, 240001	170×42	10	486201
C513036	⌀3×36	250001, 240001	170×42	10	486202
C518036	⌀8×36	250001, 240001	170×42	10	486203

»For 10-Piece Set, please refer to page 83.

Mounting quantity: 1

One point

Removal of a rusted or stuck screw

Hitting the handle with a hammer causes the impact to be converted into rotational force.

