

Datasheet

ENGLISH

RS PRO, 12 V dc, 3000 gcm, Brushed DC Geared Motor, Output Speed 290 rpm

Stock No: 321-3164



Specifications:

Output Speed	290 rpm
Supply Voltage	12 V dc
Maximum Output Torque	3000 g.cm
DC Motor Type	Brushed
Shaft Diameter	6mm
Power Rating	19.8 W
Gearhead Type	Spur
Length	78.2mm
Width	39mm
Current Rating	2.81A
Weight	255g

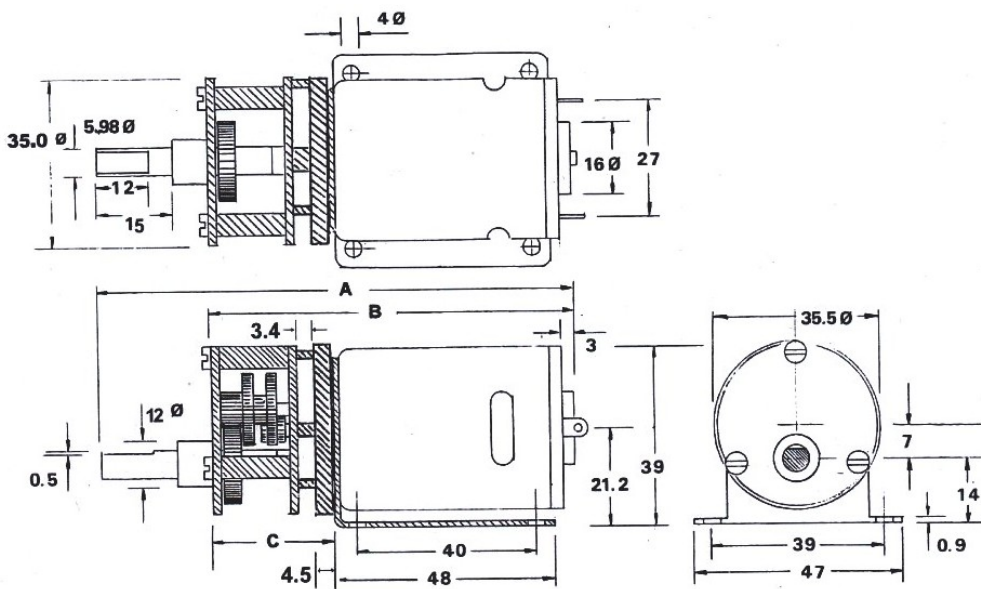

Operating relative humidity 20% ~ 85%
 Operating temperature range -10°C ~ +60°C

Ratio	A	B	C
50:1	103.2mm	78.2mm	26.2mm

Gearbox Housing material	Metal
Backlash at no-load	< 2°
Bearing at output	Sleeve bearings
Radial load (10mm from flange)	< 1 kgf
Shaft axial load	< 0.7 kgf
Shaft press fit force max	< 20 kgf
Radial play of shaft	< 0.05mm
Thrust play of shaft	< 0.35mm

Reduction Ratio	Rated tolerance Torque	Max momentary Tolerance Torque	Efficiency
1/50	3 kgf-cm Max.	9 kgf-cm	66%

Reduction Table RPM SUPPLY VOLTAGE	4.5v	6v	9v	12v	15v
321-3164	109	145	218	290	363

Note: Motor speeds may vary by (+) or (-) 12.5%