

RevNo	Revision note	Date	Signature	Checked
-------	---------------	------	-----------	---------

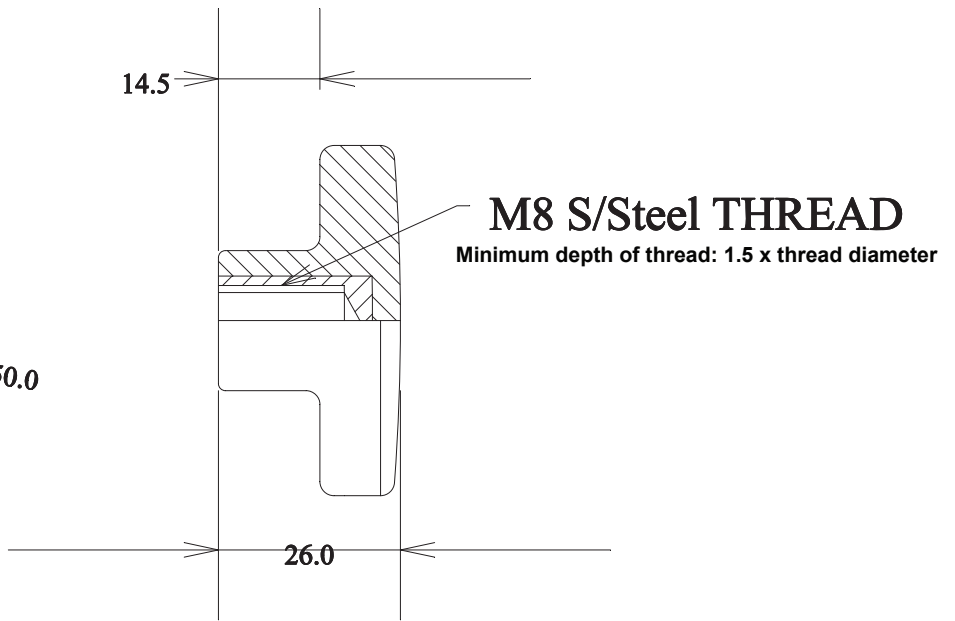
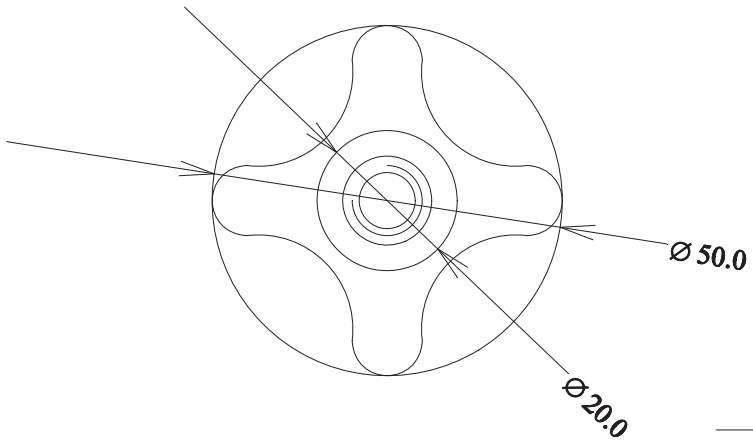

Itemref	Quantity	Title	<b>Star Knob - Polypropylene REV.2</b>		Article No./Reference	
Designed by	Checked by	Approved by - date	Filename	Date	Scale	
				06 / 04 / 2010		
				<b>RS 7027740</b>		
				Edition	Sheet	
				1	1/1	