

Ti200, Ti300, Ti400

Thermal Imagers

Users Manual

PN 4281773

September 2013

© 2013 Fluke Corporation. All rights reserved.

Specifications are subject to change without notice.

All product names are trademarks of their respective companies.

LIMITED WARRANTY AND LIMITATION OF LIABILITY

Each Fluke product is warranted to be free from defects in material and workmanship under normal use and service. The warranty period is two years and begins on the date of shipment. Parts, product repairs, and services are warranted for 90 days. This warranty extends only to the original buyer or end-user customer of a Fluke authorized reseller, and does not apply to fuses, disposable batteries, or to any product which, in Fluke's opinion, has been misused, altered, neglected, contaminated, or damaged by accident or abnormal conditions of operation or handling. Fluke warrants that software will operate substantially in accordance with its functional specifications for 90 days and that it has been properly recorded on non-defective media. Fluke does not warrant that software will be error free or operate without interruption.

Fluke authorized resellers shall extend this warranty on new and unused products to end-user customers only but have no authority to extend a greater or different warranty on behalf of Fluke. Warranty support is available only if product is purchased through a Fluke authorized sales outlet or Buyer has paid the applicable international price. Fluke reserves the right to invoice Buyer for importation costs of repair/replacement parts when product purchased in one country is submitted for repair in another country.

Fluke's warranty obligation is limited, at Fluke's option, to refund of the purchase price, free of charge repair, or replacement of a defective product which is returned to a Fluke authorized service center within the warranty period.

To obtain warranty service, contact your nearest Fluke authorized service center to obtain return authorization information, then send the product to that service center, with a description of the difficulty, postage and insurance prepaid (FOB Destination). Fluke assumes no risk for damage in transit. Following warranty repair, the product will be returned to Buyer, transportation prepaid (FOB Destination). If Fluke determines that failure was caused by neglect, misuse, contamination, alteration, accident, or abnormal condition of operation or handling, including overvoltage failures caused by use outside the product's specified rating, or normal wear and tear of mechanical components, Fluke will provide an estimate of repair costs and obtain authorization before commencing the work. Following repair, the product will be returned to the Buyer transportation prepaid and the Buyer will be billed for the repair and return transportation charges (FOB Shipping Point).

THIS WARRANTY IS BUYER'S SOLE AND EXCLUSIVE REMEDY AND IS IN LIEU OF ALL OTHER WARRANTIES, EXPRESS OR IMPLIED, INCLUDING BUT NOT LIMITED TO ANY IMPLIED WARRANTY OF MERCHANTABILITY OR FITNESS FOR A PARTICULAR PURPOSE. FLUKE SHALL NOT BE LIABLE FOR ANY SPECIAL, INDIRECT, INCIDENTAL, OR CONSEQUENTIAL DAMAGES OR LOSSES, INCLUDING LOSS OF DATA, ARISING FROM ANY CAUSE OR THEORY.

Since some countries or states do not allow limitation of the term of an implied warranty, or exclusion or limitation of incidental or consequential damages, the limitations and exclusions of this warranty may not apply to every buyer. If any provision of this Warranty is held invalid or unenforceable by a court or other decision-maker of competent jurisdiction, such holding will not affect the validity or enforceability of any other provision.

Fluke Corporation
P.O. Box 9090
Everett, WA 98206-9090
U.S.A.

Fluke Europe B.V.
P.O. Box 1186
5602 BD Eindhoven
The Netherlands

11/99

To register your product online, visit <http://register.fluke.com>.

Table of Contents

Title	Page
Introduction	1
How to Contact Fluke	2
Safety Information	2
Radio Frequency Data	5
Accessories	5
Before You Start	7
Battery	8
Two-Bay Battery Charger Base	8
On-Imager AC Power Socket	9
Optional 12 V Vehicle Charger	10
Power On and Off	10
Operation in Extreme Conditions	10
Features and Controls	11
Primary and Secondary Triggers	13
Focus	13
Control Buttons	14
Touch Screen	14
How to Use the Menus	15
Image Capture	15
IR-PhotoNotes™	16
Voice Annotation (Recording)	17
Listen to a Voice Annotation (Recording)	17
Edit Captured Infrared Image	18
Save Captured Infrared Image	18
Micro SD Memory Card	19
Temperature Measurement	20
SmartView® Software	20

Menus	21
Measurement Menu	21
Range	21
Level/Span	21
Emissivity Adjustment.....	23
Background (Reflected Background Temperature Compensation).....	25
Transmission/Transmittance Adjustment.....	25
Spot Temperatures	26
Spot Markers	26
Center Box.....	27
Image Menu	28
Palette	28
IR-Fusion® Technology.....	29
Color Alarms.....	30
Display Graphics Presentation	31
Logo	31
Camera Menu	32
LaserSharp™ Auto Focus System	32
Backlight.....	33
Torch	33
Memory Menu	34
Review Image Files	34
Delete Image Files.....	34
Settings Menu	35
Units	35
File Format	35
Auto Off	36
Date.....	37
Language	38
Wireless Connectivity	38
Image Storage.....	38
Advanced Settings.....	39
Streaming Video	40
HDMI®	40
Remote Control (Ti400)	41
Maintenance	41
How to Clean the Case	41
Battery Care	42
General Specifications.....	43
Detailed Specifications	45

List of Tables

Table	Title	Page
1.	Symbols	4
2.	Accessories	5
3.	Features and Controls	11
4.	Overview of Controls	14
5.	Palettes	28

List of Figures

Figure	Title	Page
1.	Lens Cover Laser Warning.....	3
2.	Add-On Lens Installation	6
3.	SD Memory Card Insertion and Removal.....	19
4.	Level and Span Settings	23

Introduction

The Fluke Ti200, Ti300, and Ti400 Thermal Imagers (the Product or Imager) are handheld, infrared imaging cameras for use in many applications. These applications include equipment troubleshooting, preventive and predictive maintenance, building diagnostics, and research and development.

All Imagers display thermal images on a high-visibility, industrial-quality 640 x 480 LCD touch screen and can save images to a removable memory card. Saved images and data can be transferred through the memory card to a PC, a direct USB connection to the PC, or by wireless transfer to a PC or mobile device.

The Imager includes SmartView[®] software. This software is a high-performance, professional software suite that allows for quality analysis and reporting. SmartView[®] Mobile software is also available for use on mobile devices.

A rugged, rechargeable lithium-ion smart battery provides power to the Imager. Direct AC power is accessible with the included AC power adapter.

All Imagers have the Fluke LaserSharp[™] Auto Focus System, as well as advanced manual focus capabilities. They also include many useful features and functions associated with IR-Fusion[®] technology with Autoblend[™] mode, IR-PhotoNotes[™] photo annotation system, WiFi[™] connectivity, Bluetooth[®] connectivity, and HDMI[®] video connectivity.

How to Contact Fluke

To contact Fluke, call one of the following telephone numbers:

- USA: 1-800-760-4523
- Canada: 1-800-36-FLUKE (1-800-363-5853)
- Europe: +31 402-675-200
- Japan: +81-3-6714-3114
- Singapore: +65-6799-5566
- Anywhere in the world: +1-425-446-5500

Or, visit Fluke's website at www.fluke.com.

To register your Product, visit <http://register.fluke.com>.

To view, print, or download the latest manual supplement, visit <http://us.fluke.com/user/support/manuals>.

Safety Information

A **Warning** identifies conditions and procedures that are dangerous to the user.

A **Caution** identifies conditions and procedures that can cause damage to the Product or the equipment under test.

Warning

To prevent eye damage and personal injury:

- **Do not look into the laser. Do not point laser directly at persons or animals or indirectly off reflective surfaces.**
- **Do not open the Product. The laser beam is dangerous to eyes. Have the Product repaired only through an approved technical site.**

Additional laser warning information is on the inside of the Product lens cover, see Figure 1.



hie05.eps

Figure 1. Lens Cover Laser Warning

⚠ Warning













To prevent personal injury:

- **Read all safety information before you use the Product.**
- **Carefully read all instructions.**
- **Use the Product only as specified, or the protection supplied by the Product can be compromised.**
- **Replace the batteries when the low battery indicator shows to prevent incorrect measurements.**
- **Do not use the Product if it operates incorrectly.**
- **Do not use the Product if it is damaged.**

- See emissivity information for actual temperatures. Reflective objects result in lower than actual temperature measurements. These objects pose a burn hazard.
- Do not use the Product around explosive gas, vapor, or in damp or wet environments.
- Do not put battery cells and battery packs near heat or fire. Do not put in sunlight.

Table 1 is a list of symbols used on the Imager and in this manual.

Table 1. Symbols

Symbol	Description	Symbol	Description
	Important information. See manual.		Warning. Laser.
	Connected to ac power. Battery removed.		Battery status. Battery charging when animated.
	On/Off Symbol.		Conforms to requirements of European Union and European Free Trade Association.
	Conforms to relevant Australian standards.		Conforms to relevant North American Safety Standards.
	Conforms to relevant South Korean EMC standards.		Japan Quality Association
	This Product contains a lithium-ion battery. Do not mix with the solid waste stream. Spent batteries should be disposed of by a qualified recycler or hazardous materials handler per local regulations. Contact your authorized Fluke Service Center for recycling information.		
	This product complies with the WEEE Directive (2002/96/EC) marking requirements. The affixed label indicates that you must not discard this electrical/electronic product in domestic household waste. Product Category: With reference to the equipment types in the WEEE Directive Annex I, this product is classed as category 9 “Monitoring and Control Instrumentation” product. Do not dispose of this product as unsorted municipal waste. Go to Fluke's website for recycling information.		

Radio Frequency Data

See page 39 for instructions on how to access digital copies of the radio licenses on the Imager.

Accessories

Table 2 is a list of the accessories available for the Imager.

Table 2. Accessories

Model	Description	PN
FLK-TI-SBP3	Smart Battery Pack	3440365
FLK-TI-SBC3B	Charging Base/Power Supply with Adapters	4354922
TI-CAR CHARGER	12 V Vehicle Charger Adapter	3039779
FLK-TI-VISOR3	Sun Visor	4335377
FLK-TI-TRIPOD3	Tripod Mounting Accessory	4335389
BOOK-ITP	Introduction to Thermography Principles	3413459
FLK-LENS/TELE2	Infrared Telephoto Lens	4335377
FLK-LENS/WIDE2	Infrared Wide-Angle Lens	4335361

Optional telephoto and wide-angle lenses expand the flexibility and allow more applications for your infrared inspection work. See Figure 2 for information about how to install a lens.

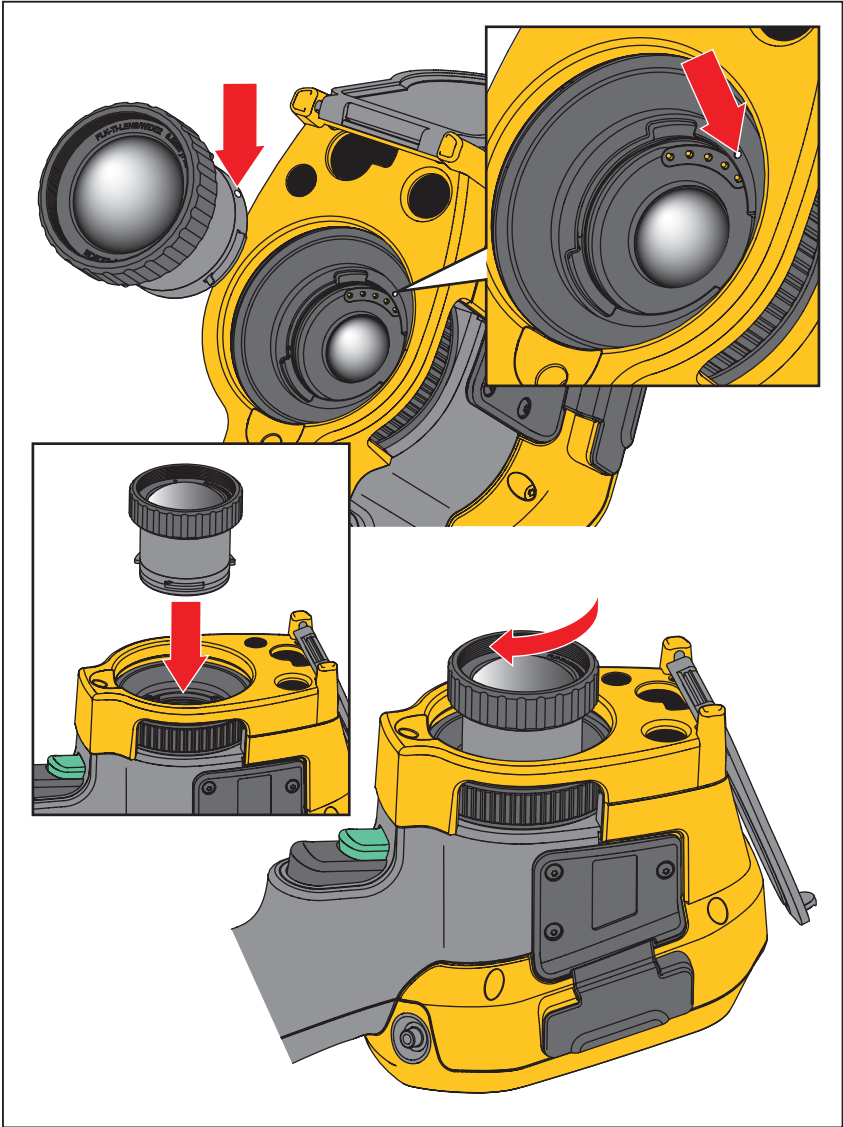

Figure 2. Add-On Lens Installation

hie08.eps

Before You Start

Carefully unpack the items in the shipment box:

- Thermal Imager
- AC Power Supply with Mains Adapters
- Two-Bay Battery Charge Base
- 2 Lithium-ion Smart Batteries
- Hard Carrying Case
- USB Cable
- HDMI Cable
- Removable Memory Card^[1]
- Soft Transport Bag
- Adjustable Hand Strap (Left-hand or Right-hand use)
- Users Manuals in print (English, Spanish, French, German, Chinese)^[2]
- Users Manuals on CD^[2]
- SmartView[®] Software
- Warranty Registration Card

Note

[1] Fluke recommends the memory card that is supplied with the Imager or available from Fluke. Fluke does not warrant the use or reliability of aftermarket memory cards of different brands or capacities.

[2] To request a printed manual of a language not supplied with your product, email Fluke at TPubs@fluke.com. Specify the product name and language preference in the subject line.

Battery

Before you use the Imager for the first time, charge the battery for a minimum of two and one-half hours. The battery status shows on the five-segment charge indicator.

Warning

To prevent personal injury, do not put battery cells and battery packs near heat or fire. Do not put in sunlight.

Note

New batteries are not fully charged. Two to ten charge/discharge cycles are necessary before the battery charges to its maximum capacity.

To charge the battery, use one of the options that follow:

Two-Bay Battery Charger Base



1. Connect the ac power supply to the ac wall outlet and connect the dc output to the charger base.
2. Put one or two smart batteries into bays of charger base.
3. Charge batteries until charge indicators show "full."
4. Remove smart batteries and disconnect the power supply when batteries are fully charged.

On-Imager AC Power Socket

1. Connect the ac power adapter into an AC wall outlet and connect the dc output to the Imager's ac power socket.  flashes on the display while the battery charges with the ac power adapter.
2. Charge until the charge indicator on the display does not flash.
3. Disconnect ac power adapter when the smart battery is fully charged.

Note

Make sure that the Imager is near room temperature before you connect it to the charger. See the charging temperature specification. Do not charge in hot or cold areas. When you charge in extreme temperatures, battery capacity may be decreased.

 shows in the lower left-hand corner of the display when the Imager is connected to ac power and the battery is removed. When the Imager's power is off and the ac power adapter is connected,  flashes in the center of the display to show that the battery charge is in process.

Keep the Imager attached to the charger until the battery condition icon shows a full charge. If you remove the Imager from the charger before a full charge shows, it may have a reduced run-time.

Note

When the battery is connected to ac power or the unit is in video mode, the Sleep Mode/Auto Off feature is disabled automatically.

Optional 12 V Vehicle Charger

1. Connect the 12 V adapter into the 12 V accessory socket of the vehicle.
2. Connect the output to the ac power socket of the Imager.
3. Charge until the indicator shows *full* on the screen.
4. Disconnect the 12 V adapter and Imager when battery is fully charged.

Caution

To prevent damage to the Imager, remove it from the DC car charger before you start or jump start the vehicle.

Power On and Off

To turn on or turn off the Imager, push and hold  for two seconds, see Table . The Imager has Power Save and Auto Off features. See page 36 for more information about how to set these features.

Note

All thermal imagers need sufficient warm-up time for the most accurate temperature measurements and best image quality. This time can often vary by model and by environmental conditions. Although most imagers are fully warmed up in 3-5 minutes, it is always best to wait a minimum of 10 minutes if the most accurate temperature measurement is very important to your application. When you move an Imager between environments with large differences in ambient temperature, more adjustment time can be required.

Operation in Extreme Conditions

Storage and/or continual operation of the Imager in extreme ambient temperature conditions can result in temporary interruption of operation. If this occurs, let the Imager stabilize (cool down or warm up) before you resume operation.

Features and Controls

Table 3 shows the Imager features and controls.

Table 3. Features and Controls

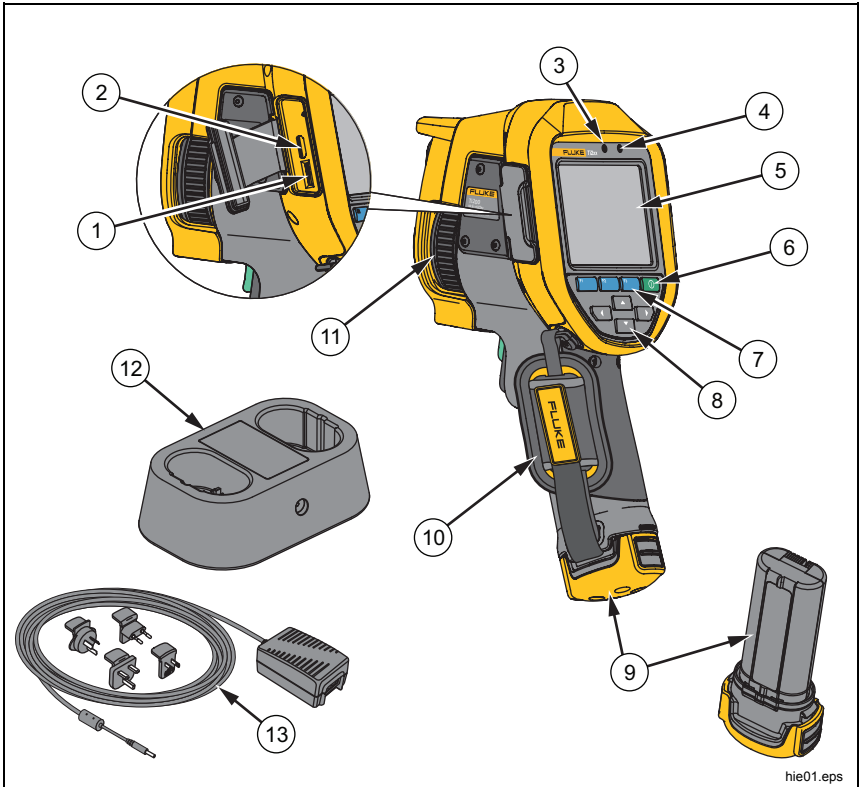

hie01.eps

Item	Description
①	HDMI Connection
②	USB Cable Connection
③	Microphone
④	Speaker
⑤	LCD Display
⑥	⏻ Power On/Off
⑦	Function Buttons (F1, F2, and F3)
⑧	Arrow Buttons
⑨	Lithium-ion Smart Battery

Table 3. Features and Controls (cont.)

Item	Description
⑩	Hand Strap
⑪	Manual Focus Control
⑫	2-Bay Battery Charging Base
⑬	AC Power Supply with Mains Adapters
⑭	Connector Cover
⑮	AC Adapter/Charger Input Terminal
⑯	Removable Micro SD Memory Card Slot
⑰	Micro USB Cable Connection
⑱	LED Torch/Flashlight
⑲	Retractable Lens Cover
⑳	Visual Light Camera Lens
㉑	Laser Pointer/Range Finder
㉒	Infrared Camera Lens
㉓	Secondary Trigger
㉔	Primary Trigger

hie06.eps

Primary and Secondary Triggers

The two-part trigger is located in the standard trigger position for a pistol-grip device. The larger, green trigger is the primary trigger. The smaller, black trigger is the secondary trigger.

In normal operation, the function of the primary trigger is to capture a thermal image for possible storage to memory by the user.

The secondary trigger operates the LaserSharp™ Auto Focus System and laser pointer. See page 32 for information about how to enable and disable the LaserSharp™ Auto Focus System.

Focus

The Imager uses the LaserSharp Auto Focus System and an advanced manual focus system. Correct focus is important in all imaging applications. Correct focus makes sure that the infrared energy is correctly directed onto the pixels of the detector. Without correct focus, the thermal image can be blurry and the radiometric data may be inaccurate. Out-of-focus infrared images are frequently unusable or of little value.

The LaserSharp Auto Focus System, only from Fluke, uses a precision-adjusted and aligned laser pointer to indicate the area of focus. To focus with the LaserSharp Auto Focus System, depress the secondary (black) trigger on the Imager handle. Aim the laser pointer at the target. When satisfied with the location of the laser pointer, release the trigger. The system automatically, rapidly, and reliably focuses on the precise point where the laser was aimed.

Note

- *The user can enable and disable the LaserSharp Auto Focus System.*
- *The laser pointer is aligned parallel to the infrared lens. If using AutoBlend Mode, the laser pointer dot will always be positioned just above the center point marker on the LCD display. However, it is easier to use your eyes to locate the visible laser pointer on the object under inspection.*

To focus with the advanced manual focus system, place finger on the electronically-driven focus wheel control and rotate the control until the inspection object is in proper focus.

Note

The user is able to use the advanced manual focus as a manual override of the LaserSharp™ Auto Focus System.

Control Buttons

Three function buttons (F1 F2 F3) and four arrow buttons (◀ ▶ ▲ ▼) are the primary controls. These buttons move the cursor through the menu structure to set the features.

Table 4 is an overview of the buttons and their actions. In live Manual Mode, the arrow buttons are always active to adjust Level and Span.

In general, push:

- F3 to set the change and go back to the live view.
- F2 to set the change and go back to the previous menu.
- F1 to cancel the change and go back to the live view.

Table 4. Overview of Controls

Button	Button Label / Action
F3 or Primary Trigger	Cancel
F1 or Primary Trigger	Done (exit from Menu structure)
F1	Select or OK
F2	Back
▲ ▼ ▶ ▶	Move cursor to highlight an option

Touch Screen

The touch screen enables you to interact directly with what is displayed. To change parameters or select function and options, touch a target on the display with a finger. Touch targets are easy to recognize, such as arrows to indicate a drop-down list for a selection of options.

The touch screen has a backlight for work in dimly lit spaces. To change the backlight intensity, see page 33.

How to Use the Menus

The menus, coupled with the three function buttons (F1, F2, F3) and arrow buttons, are the access for thermal image display, camera features, measurement, advanced functions, memory review, and settings for date, time, language, units, file format, and Imager information.

To open the primary menu, push F2. The primary menu shows five secondary menus for Measurement, Image, Camera, Memory, and Settings. The text above each function button (F1, F2, F3) applies to that button throughout all menu screens.

Push F2 to open the primary menu and push ▲ ▼ ▶ ◀ to cycle through the secondary menus. Each secondary menu lists an options menu. Push ▲ ▼ ▶ ◀ to cycle through the options.

The primary, secondary, and option menus close 10 seconds after the last push of a function button. The option selection menu stays open until you make the selection, go up a menu level, or cancel the action.

Image Capture

Point the imager at the object or area of interest. Focus on the object using the LaserSharp™ Auto Focus System or advanced manual focus (See page 13 on how to focus). Pull and release the primary trigger. This will capture and freeze the image. The image is now in the memory buffer and you can choose to save or edit the image. Push F1 to save the image or pull the primary trigger again or F3 to cancel and return to the live view.

Depending on the selected file format settings, the Imager shows the captured image and a menu bar. The menu bar lets you save the image, edit some image settings, and add voice annotation or IR-PhotoNotes™ digital photos. To change the file format, see *File Format* on page 35.

IR-PhotoNotes™

The IR-PhotoNotes™ photo annotation system allows the user to capture and add up to five visible (digital) images of various objects, text, or other information that is related to the analysis and reporting of an infrared image. Examples of possible annotations include motor name plates, printed information or warning signs, larger views of the environment or room, and related equipment or objects. Up to five images can be captured with the visible image that is stored in addition to the aligned infrared and visible images used in IR-Fusion® technology. These visible images are only available in the .is2 file format and are stored in the file so you do not need to collate multiple files at a later time.

To add photos using the IR-PhotoNotes annotation system:

1. With an infrared image in the buffer, push **F2** to open the **EDIT IMAGE** menu.
2. Push **▲/▼** to highlight **IR-PhotoNotes**.
3. Push **F1** to enter the Picture mode.
4. Focus the Imager on the object and pull the primary trigger.
5. Push **F2** when done.
6. Pull the primary trigger to capture additional pictures.
7. Push **F1** save the pictures with the image.



Voice Annotation (Recording)

To add a voice (audio) recording:

1. With an infrared image in the buffer, push **F2** to open the **EDIT IMAGE** menu.
2. Push **▲**/**▼** to highlight **Add Audio**.
3. Push **F1** to record up to 60 seconds of audio. The display updates to show the recorded time.
4. Push **F1** to pause the recorder.
5. Push **F2** when done.
6. Push **F1** to review the audio file or **F2** to save the audio with the image.

Voice annotation is only available in the .is2 file format and is stored in the file so you do not need to collate multiple files at a later time.

Listen to a Voice Annotation (Recording)

The voice (audio) recording replays through the speaker.



To play back:

1. Do the steps in the *Review Image Files* section on page 34 to see the image on the display.
2. Push **F1**.
3. Push **F1** to set **Audio**.
4. Push **F1** to listen to the audio.
5. Push **F1** again to pause the audio.

Edit Captured Infrared Image

Before saving a file, you can edit or modify the image.

To edit:

1. With an image in the buffer, go to **EDIT IMAGE > Edit Image**.
2. Push / to highlight an option.
3. Push  to save the changes with the file.

Save Captured Infrared Image

To save an image as a data file:

1. Focus on the object of interest or inspection area.
2. Pull the trigger to capture the image. The image is now in the buffer and you can save or edit.
3. Push  to save the image as a file and go back to the live view.

Micro SD Memory Card

To eject a Micro SD memory card, push in on the exposed edge of the card and then release. The card should pop partially out after you release it. Carefully pull the card out of the slot.

To use the Micro SD memory card, make sure that the write-protect lock is open. See Figure 3. Push the card in until it catches.

The Micro SD memory card comes with an SD adapter for insertion into a PC or multi-function card reader if desired.

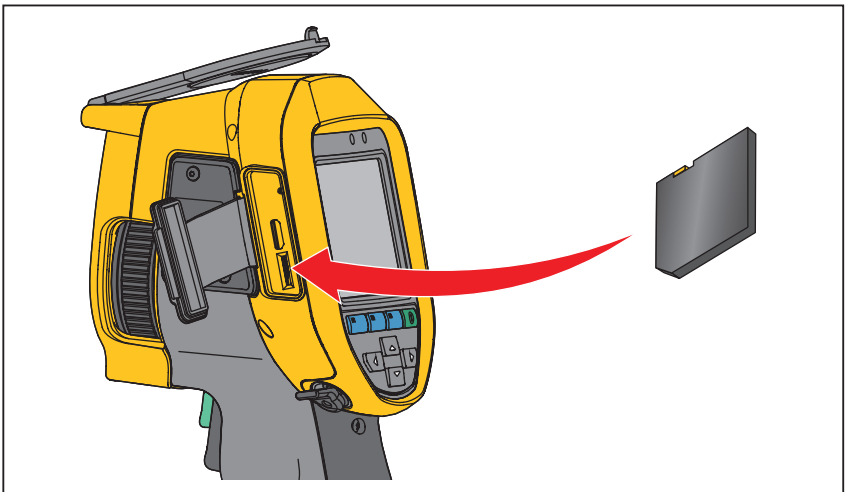

Figure 3. Micro SD Memory Card Insertion and Removal

hie03.eps

For information about how to save data, see page 18. For information about how to view or erase a stored image, see page 34.

Temperature Measurement

All objects radiate infrared energy. The quantity of energy radiated is based on the actual surface temperature and the surface emissivity of the object. The Imager senses the infrared energy from the surface of the object and uses this data to calculate an estimated temperature value. Many common objects and materials such as painted metal, wood, water, skin, and cloth are very good at radiating energy and it is easy to get relatively accurate measurements. For surfaces that are good at radiating energy (high emissivity), the emissivity factor is $\geq 90\%$ (or 0.90). This simplification does not work well on shiny surfaces or unpainted metals as they have an emissivity of < 0.60 . These materials are not good at radiating energy and are classified as low emissivity. To more accurately measure materials with a low emissivity, an emissivity correction is necessary. Adjustment to the emissivity setting will usually allow the Imager to calculate a more accurate estimate of the actual temperature.

Warning

To prevent personal injury, see emissivity information for actual temperatures. Reflective objects result in lower than actual temperature measurements. These objects pose a burn hazard.

SmartView[®] Software

SmartView[®] software is supplied with the Imager. This software is intended for Fluke Imagers and contains features to analyze images, organize data and information, and make professional reports. SmartView[®] allows audio annotations and photos from the IR-PhotoNotes[™] annotation system to be reviewed on a PC. SmartView is used to export IR and visible images as .jpeg, .jpg, .jpe, .jfif, .bmp, .gif, .dip, .png, .tif, or .tiff formatted files.

SmartView Mobile Software is also available for flexibility away from your PC or in the field.

Menus

The menus, together with the three function buttons (**F1**, **F2**, **F3**) and arrow buttons, are access for thermal image display, camera features, memory setup, and settings for date, time, language, units, file format, and Imager information.

Measurement Menu

The Measurement Menu has settings for the calculation and display of radiometric temperature measurement data related to the thermal images. These settings include the Temperature Range selection, Level/Span adjustment, Emissivity, Background, Transmission, Spot Temperatures, Markers, and Center Box.

Range

Preset measurement ranges and a Full Automatic Range are available on the Imager. To select the range:

1. Go to **Measurement > Range**.
2. Push **▲/▼** to select between the preset ranges or the full automatic range.
3. Push **F1** to set the range.

Level/Span

Level and span are set for automatic or manual adjustment. To choose between automatic or manual level and span:

1. Go to **Measurement > Set Level/Span**.
2. Push **▲/▼** to select between the **Auto** and **Manual** ranging or **Set Level/Span**.
3. Push **F1** to set the new selection.

In manual mode the Set Level/Span control is active. Use **▲/▼** to adjust the level setting. Use **◀/▶** to adjust the span setting. See the section, Detailed Specifications, for more information about the minimum span.

Fast Auto/Manual Range Toggle

When NOT in a menu mode, push and release **F1** to toggle between Auto Range and Manual Range. The icon in the upper right-hand corner of the LCD screen will indicate the change by saying Auto or Manual.

Fast Auto Rescale (in Manual Mode)

When in Manual Range and NOT in a menu mode, push and release **F3** to automatically rescale the level and span range for objects in the thermal field of view. This feature operates the Imager in a semi-automatic mode if manual fine re-adjustment of level and span with the arrow buttons is not necessary. Rescaling can be done as often, or as little, as needed.

Note

The Imager always powers up in the same Level and Span mode, Auto or Manual, as when it was powered down.

Temperature Level for Manual Operation Mode

When put into manual ranging, the level setting moves the thermal span up or down within the total temperature range. See Figure 4. In the live manual mode, the arrow buttons are always available to adjust the level and span.

To set the level:

1. Push **▲** to move the range to a higher temperature level.
2. Push **▼** to move the range to a lower temperature level.

While you adjust the manual level, the scale along the right side of the display shows the thermal span as it moves to different levels within the total range.

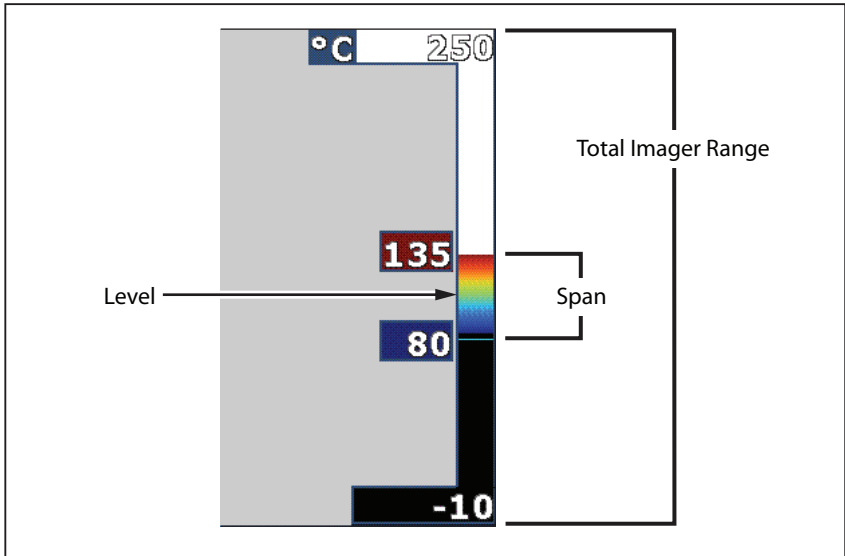

hie07.eps

Figure 4. Level and Span Settings

Temperature Span for Manual Operation Mode

When in manual mode, the span setting contracts or expands in a selected palette in a temperature range within the total range. See Figure 4. In the live manual mode, the arrow buttons are always available to adjust the level and span.

To adjust the temperature span:

1. Push **▶** to increase or widen the temperature span.
2. Push **◀** to decrease or narrow the temperature span.

While you adjust the manual span, the scale along the right side of the display shows the thermal span increasing or decreasing in size.

Emissivity Adjustment

The correct emissivity values are important for the Imager to make the most accurate temperature measurement calculations. Emissivity of a surface can have a large effect on the apparent temperatures that the Imager observes. Understanding the emissivity of the surface being inspected can, but not always, allow you to obtain more accurate temperature measurements.

If you set a value that is <0.60 ,  shows on the Imager display with this caution:

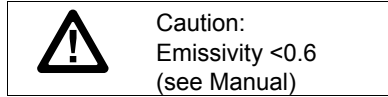

Note

Surfaces with an emissivity of <0.60 make reliable and consistent determination of actual temperatures problematic. The lower the emissivity, the more potential error is associated with the Imager's temperature measurement calculations. This is also true even when adjustments to the emissivity and reflected background adjustments are performed properly.



Emissivity is set directly as a value, or from a list of emissivity values for some common materials.

Note

*If the Display is set to **Display All**, you see the information about current emissivity as $\epsilon = x.xx$.*

Adjust by Number



To set the emissivity value:

1. Go to **Measurement > Emissivity > Adjust Number**.
2. Push / to change the value.

A custom emissivity value is indicated when any value not in the standard emissivity table is selected.

Select by Table





To select from a list of common materials:

1. Go to **Measurement > Emissivity > Select Table**.
2. Push / to highlight the material.
3. Push  to select the material.

Background (Reflected Background Temperature Compensation)

Compensation for reflected background temperature is set in the Background tab. Very hot objects or very cold objects can affect the apparent temperature and measurement accuracy of the target or object of interest, especially when surface emissivity is low. Adjustment of the reflected background temperature can make the temperature measurement better in many situations. For more information, see *Emissivity Adjustment*.

To adjust the background temperature:

1. Go to **Measurement > Background**.
2. Push  /  to change the value.
3. Push  or  when done.





Note

*If the Display is set to **Display All**, you see the information about current reflected background temperature as **BG = xx.x**.*

Transmission/Transmittance Adjustment

When you do infrared inspections through infrared-transparent windows (IR windows), not all of the infrared energy emitted from the objects of interest is transmitted through the optical material in the window. If the transmission percentage of the window is known, you can adjust this percentage in the Imager or in the SmartView[®] software. Adjustment of the transmission correction can make the accuracy of the temperature measurement better in many situations.

To adjust the transmission percentage:

1. Go to **Measurement > Transmission**.
2. Push  /  to adjust the percentage between 10 % and 100 %.
3. Push  or  when done.



Note

*If Display Information is set to **Display All**, you see the information about current transmission correction as **τ = xx**.*

Spot Temperatures

The Spot Temperatures are floating HI and LO temperature indicators that move on the display as the temperature measurements of the image fluctuate.

To turn on/off the hot and cold spot indicators:

1. Go to **Measurement > Spot Temp.**
2. Push / to highlight **ON** or **OFF**.
3. Push **F1** or **F2** to set the new value.



Note

*If the Display is set to **Display All**, you see the information about current transmission correction as $\tau = \text{xxx}\%$.*





Spot Markers

Up to three adjustable, fixed-temperature spot markers are available on the display. You can use these markers to highlight a region before you save the image. The marker selection is set as All Off, One Marker, Two Markers, or Three Markers.

To set a Marker:

1. Go to **Measurement > Markers**.
2. Push the / to highlight the function between **All Off**, **One Marker**, **Two Markers**, and **Three Markers**.
3. Push **F1** to set the marker option and go to the "Move Marker" display. You will see the Move Marker icon and the labels on the function buttons change to **Done**, **Next**, and **Cancel**.

To change the Marker position on the display:

1. Push     to move the Marker location on the image.
2. Push **F2** to highlight the next marker. Do Step 1 again.
3. Do Step 2 for a third marker.
4. Push **F1** when done.



Center Box

The Center Box feature is an adjustable temperature measurement zone (box) that you can center on the infrared image. This zone (box) expands and contracts to different levels within the infrared image. The zone lets the user see an approximate maximum (MAX), average (AVG), and minimum (MIN) temperature measurement in that area. When in AUTO Level and Span mode, the Imager automatically sets the level and span according to the infrared scene within the parameters of the Center Box.

Note

When using the Center Box, the level and span of the Imager is adjusted to the thermal scene within the Center Box.

To enable or disable the Center Box feature:

1. Go to **Measurement > Center Box**.
2. Push  /  to highlight **ON** or **OFF**.
3. Push  to set the new value.

To set the size of the **Center Box** when enabled:









1. Push  /  to highlight **Set Size**.
2. Push  to go to the adjustment screen.
3. Push  to increase the size of the **Center Box**.
4. Push  to reduce the size of the **Center Box**.
5. When satisfied with the size of the **Center Box**, push:
 -  to set the change and exit the menus.
 -  to set the change and go back to the previous menu.
 -  to cancel the change and go back to the live view.

Image Menu

The Image menu has controls for different features used in the presentation of the infrared image on the Imager's LCD and some saved image files.

Note

Data saved as .is2 or .is3 formats can easily be modified within SmartView software. Still images saved in .bmp or .jpg format, as well as video saved in .avi format will retain image settings at the time of capture and save.

Palette

The Palette menu lets you change the false-color presentation of the infrared images on display or captured. Some palettes are more suitable for specific applications and can be set as required. Two different palette presentation modes are available, see Table 5. The Standard Palettes offer an equal, linear presentation of colors that allow for best presentation of detail. The Ultra Contrast™ Palettes offer a weighted presentation of colors. These palettes work best in situations with high thermal contrast for extra color contrast between the high temperatures and low temperatures.

Table 5. Palettes

Standard Palettes	Ultra Contrast™ Palettes
Grayscale	Grayscale Ultra
Grayscale Inverted	Grayscale Inverted Ultra
Blue-Red	Blue-Red Ultra
High Contrast	High Contrast Ultra
Hot Metal	Hot Metal Ultra
Ironbow	Ironbow Ultra
Amber	Amber Ultra
Amber Inverted	Amber Inverted Ultra

To switch between palettes:

1. Go to **Image > Palette > Standard** or **Ultra Contrast**.
2. Push  /  to highlight a palette.
3. Push  to set the new palette.

To change the palette color:

1. Go to **Image > Palette > Set Palette**.
2. Push  /  to highlight the palette color.
3. Push  to set the new palette color.

Saturation Colors is an option that you can choose as off, standard, red/blue, or white/black.

IR-Fusion[®] Technology

IR-Fusion[®] technology makes it easier to understand, analyze, and communicate infrared images through the use of an aligned visible image and infrared image. The Imager automatically captures a visible image with every infrared image to show you precisely where a potential problem might be, and then allows you to more effectively communicate it to others.

IR-Fusion[®] technology has different modes:



Picture-in-Picture (PIP) AutoBlend (min, mid, max)



Full AutoBlend (min, mid, max)





Visible

Note

The visible image and infrared image can be customized or separated in SmartView and SmartView Mobile Software when you use the .is2 file format.

To set the IR-Fusion[®] technology mode:

1. Go to **Measurement > Image > IR-Fusion**.
2. Push  /  to highlight an option.
3. Push  to set the new option.

Color Alarms

The Imager has various apparent temperature color alarms. The high-temperature color alarm shows a full visible image and only shows infrared information on objects or areas that are above the set apparent temperature alarm level. The low-temperature (or dew point) color alarm shows a full visible image and only shows infrared information on objects or areas that are below the set apparent temperature (or set dew point) color alarm level. The user must manually determine and set these parameters. The imager also displays color isotherms, or infrared information, inside or outside of a set of both high and low limits.

Note

The Imager does not sense ambient or surface dew point level automatically. To use the low-temperature color alarm function as a dew point color alarm, manual determination and input of surface dew point temperature will yield the best results. Depending on the situation, the colors presented may help identify areas of concern with possible dew point condensation.

To view the Color Alarm menu:

1. Go to **Image > Color Alarm**.
2. Push **F1** to view the menu.

Set High-Temperature Color Alarm

To set a high-temperature color alarm:

1. Go to **Image > Color Alarm > Set High Alarm**.
2. Push **▲/▼** to adjust the temperature setting.
3. Push **F1** or **F2** set the new value.

Set Low-Temperature (or Dew Point) Color Alarm

To set a low-temperature/dew point color alarm:

1. Go to **Image > Color Alarm > Set Low Alarm**.
2. Push **▲/▼** to adjust the temperature setting.
3. Push **F1** or **F2** set a new value.

Outside/Inside Alarm

If you set values for the high-temperature color alarm and a low-temperature color alarm, the Imager will have the options for inside or outside isotherm color alarms.

To set an outside/inside isotherm color alarm:

1. Go to **Image > Color Alarm > Outside** or **Inside**.
2. Push:

F1 to set the change and go back to the live view.

F2 to set the change and go back to the previous menu.

F3 to cancel the change and go back to the live view.

Display Graphics Presentation

The options for how you view the on-screen graphics are in the Display menu. These options are Display All, Details and Scale, Scale Only, and Image Only.

To set the display:

1. Go to **Image > Display**.
2. Push **▲**/**▼** to highlight an option.
3. Push **F1** or **F2** set a new option.

Note

Features that have ON/OFF controls must be turned on and turned off with those controls.

Logo

A Fluke logo shows on the display and captured images. You can choose to turn on or turn off the logo:

1. Go to **Image > Logo**.
2. Push **▲**/**▼** to highlight on or off.
3. Push **F1** to set.

With SmartView software you can upload a custom logo to the Imager from your PC through the USB connection.

Camera Menu

The Camera menu has controls and options for secondary camera features such as auto focus, backlight level, and torch.

LaserSharp™ Auto Focus System



The laser pointer on the Imager is both a sighting aid and a part of the LaserSharp™ Auto Focus System. In addition, the advanced manual focus of the Imager works both when the auto focus system is enabled or disabled.

Warning

To prevent eye damage and personal injury, do not look into the laser. Do not point laser directly at persons or animals or indirectly off reflective surfaces.

The laser warning symbol () shows in the Header zone of the display when you pull the secondary trigger.



To turn on or turn off the LaserSharp Auto Focus System and the laser pointer:

1. Go to **Camera > Auto Focus**.
2. Push / to select on or off.
3.  to set the change and go back to the live view.

When the laser pointer is turned on, the secondary trigger is the control for the LaserSharp Auto Focus System. Point the Imager in the general direction of the object of interest. Pull and hold the secondary trigger to locate the laser dot on the specific area of interest. Release the trigger. The auto focus system will quickly and accurately focus on the object.

Backlight

The backlight level control is set to low, medium, and high. To set the backlight:

1. Go to **Camera > Backlight**.
2. Push / to highlight high, medium, or low.
3. Push  to set a new value.

Torch

The torch illuminates darker work areas.

To set:

1. Go to **Camera > Torch**.
2. Push  to toggle the torch between on and off.

Memory Menu

The Memory Menu allows the user to review captured images, as well as audio annotations and photos from the IR-PhotoNotes™ photo annotation system in a thumbnail view format. An icon shows to indicate any additional items saved with the infrared image or IR-Fusion technology image:





IR-PhotoNotes photos



Voice annotation





Review Image Files

To view stored images on the memory card:



1. Go to **Memory**.
2. Push   to highlight the thumbnail of the file for review.
3. Push  to review the file.

Delete Image Files

To erase one image from the memory card:

1. Go to **Memory**.
2. Push   to highlight the thumbnail of the file to delete.
3. Push  to open the **Delete** menu.
4. Highlight **Selected Image** and push . The Imager prompts you to continue or cancel.
5. Push  again to delete the file.

To erase all the images from memory:



1. Go to **Memory**.
2. Push .
3. Highlight **All Images** and push . The Imager prompts you to continue or cancel.
4. Push  to delete all files in memory.

Settings Menu

The Settings menu has adjustments for user preferences such as units of temperature measurement, file format of stored data, “save to” location choice, auto off settings, WiFi and Bluetooth settings, date, time, and language. This menu also has a section that displays information about the Imager such as model number, serial number, and firmware versions. Certificates and licenses are available from this menu.

Units

To change the temperature units:

1. Go to **Settings > Units**.
2. Push / to highlight an option.
3. Push  to set an option.

File Format

Data can be saved to the internal memory, micro SD memory card, or a USB flash memory device in different file formats. Image format selections are .bmp, .jpg, and .is2. These selections remain valid when you turn the Imager off or on.

To change the file format:

1. Go to **Settings > File Format**.
2. Push / to highlight an option.
3. Push  to set the option.

Images saved in the .is2 file format have the consolidation of all data into a single file and are more flexible for analysis and modification in the included SmartView software. This file format consolidates the infrared image, radiometric temperature data, visible image, voice annotation, and photos from the IR-PhotoNotes™ photo annotation system into one location.

For situations where a smaller file size with maximum resolution is needed and modification is not, choose the .bmp file format. For the smallest file size where modification is not needed and image quality and resolution are not as important, choose the .jpg file format.

The .bmp and .jpg files can be emailed and then opened on most PC and MAC systems without special software. These formats do not allow full analysis capabilities or modification.

The .is2 file format can be emailed and then opened with SmartView Software. This format has the maximum versatility. Visit the Fluke website or contact Fluke to find out how to download SmartView analysis and reporting software at no charge.







Auto Off

The Auto Off timer is user-defined separately for the LCD and power.

Note

Auto Off is automatically disabled when the battery is connected to AC Power.











To set the Auto Off feature:

1. Go to **Settings > Auto Off**.
2. Push   to highlight **LCD Time Out** or **Power Off**.
3. Push  /  to set the timer between 1 minute and 120 minutes.
4. Push  to set.

Date

The date can be displayed in one of two formats: **MM/DD/YY** or **DD/MM/YY**.







To set the date:

1. Go to **Settings > Date**.
2. Push / to highlight the date format.
3. Push  to set a new format.
4. Push / to highlight **Set Date**.
5. Push  to open the Set Date menu.
6. Push / to select highlight day, month, or year.
7. Push   to change the settings.
8. Push  to set the date and exit the menu.



To set the time:

1. Go to **Settings > Time**.

Time displays in two different formats: 24 hour or 12 hour. To set the time format:



2. Push / to highlight time format.
3. Push  to select.
4. Highlight **Set Time**.
5. Push  to open the Set Time menu.
6. Push / to highlight hours or minutes.

The 12 hour format has a selection to set the time as AM or PM.

7. Push  or  to change the setting.
8. Push  to set the change.

Language

To change the display to a different language:

1. Go to **Settings > Language**.
2. Push  or  to highlight the setting.
3. Push  to set a new language.



Wireless Connectivity

Your Imager is equipped with several wireless connectivity options to enhance your ability to work more efficiently and better communicate results.



WiFi™ Hotspot

You can wirelessly send a picture from the Imager to a PC, an iPhone, and an iPad through the WiFi connection. A transferred image can be viewed with SmartView Mobile or SmartView Analysis and Reporting software if installed in the device.



Bluetooth®

Bluetooth is available to connect a device such as a wireless headset. When on,  shows on the display (upper left corner).

Image Storage

The storage setting allows you to choose to save images to the internal memory, micro SD memory card, or USB flash memory.

1. Go to **Settings > Image Storage**.
2. Push  or  to change the setting.
3. Push  to select the new storage setting.

Advanced Settings

Filename Prefix

The default filename starts with IR_. You have the option to change this prefix to a different 3-character name with the touch screen keyboard.

Reset Filename

You can reset the file number to 00001.





Factory Defaults

Erases all user-set preferences and restores all of the factory default settings.





Imager Information

You can access information about the version, certifications, and licenses for the Imager from the Settings Menu.





To display the Imager Info:

1. Go to **Settings > Advanced > Imager Info**.
2. Push / to highlight **Version**.
3. Push  to view the information screen with model number, serial numbers, and firmware versions.
4. Push  to close the information screen.

To display the electronic certifications:

1. Go to **Settings > Advanced > Imager Info**.
2. Push / to highlight **Certificates**.
3. Push  to view the information screen with the Image certifications.
4. Push  to close the information screen.

To display the license information:

1. Go to **Settings > Advanced > Imager Info**.
2. Push / to highlight **Licenses**.
3. Push **F1** to view the information screen with a list of Open Source Software Licenses.
4. Push / to scroll to a specific license.
5. Touch the license name on the screen to view the information screen with the specific license agreement.
6. Push **F1** to close the information screen.

Streaming Video

The Imager can stream live infrared and IR-Fusion™ technology video to a PC that has SmartView® software installed.

To set up:

1. Attach the included USB cable to the USB port on the imager.
2. Connect the other end to a USB port on a PC.
3. In SmartView software, choose **Remote Display** from the drop down menu to begin live video streaming on the PC.

HDMI®

HDMI (High-Definition Multimedia Interface) is a compact audio/video interface for transferring uncompressed data and compressed/uncompressed digital audio data from the Imager to a compatible HDMI device.

To set up:

1. Attach the included HDMI cable to the HDMI port on the Imager.
2. Connect the other end to an HDMI video device.

Remote Control (Ti400)

The Ti400 Imager can be remotely controlled with a PC that has SmartView software installed.

To remotely control the Imager:

1. If not installed, install the latest version of SmartView software on your PC.
2. Attach the included USB cable to the USB port on the Imager.
3. Connect the other end of the cable to a USB port on the PC.  appears in the SmartView workspace.
4. Select **Remote Display** from the drop down menu.
5. Use the buttons and touch screen on the UI the same as the physical Imager.
6. Follow the instructions in the software help files for additional information about the controls on the software UI.

Maintenance

The Imager does not require maintenance.

Warning

To prevent eye damage and personal injury, do not open the Product. The laser beam is dangerous to eyes. Have the Product repaired only through an approved technical site.

How to Clean the Case

Clean the case with a damp cloth and a weak soap solution. Do not use abrasives, isopropyl alcohol, or solvents to clean the case or lens/window.

Battery Care

Warning

To prevent personal injury and for safe operation of the Product:

- Do not put battery cells and battery packs near heat or fire. Do not put in sunlight.
- Do not disassemble or crush battery cells and battery packs.
- Remove batteries to prevent battery leakage and damage to the Product if it is not used for an extended period.
- Connect the battery charger to the mains power outlet before the charger.
- Use only Fluke approved power adapters to charge the battery.
- Keep cells and battery packs clean and dry. Clean dirty connectors with a dry, clean cloth.

Caution

To prevent damage, do not expose Product to heat sources or high-temperature environments such as an unattended vehicle in the sun.

To get the best performance from the lithium-ion battery, use the guidelines that follow:

- Do not store the Imager on the charger for more than 24 hours as reduced battery life may result.
- Charge the Imager for a two-hour minimum at six-month intervals for maximum battery life. Without use, the battery will self-discharge in approximately six months. Batteries stored for long periods will need two to ten charging cycles for full capacity.
- Always operate in the specified temperature range.
- Do not store the batteries in extreme cold environments.
- Do not attempt to charge the batteries in extreme cold environments.

Caution

Do not incinerate the Product and/or battery. Go to Fluke's website for recycling information.

General Specifications

Temperature

Operating.....	-10 °C to 50 °C (14 °F to 122 °F)
Storage.....	-20 °C to 50 °C (-4 °F to 122 °F) without batteries

Relative Humidity..... 10 % to 95 % non-condensing

Altitude

Operating.....	2,000 m
Storage.....	12,000 m

Display..... 8.9 cm (3.5 in) diagonal landscape
color VGA (640 x 480) LCD with
backlight

Controls and Adjustments

- User-selectable Temperature Scale (°C/°F)
- Language Selection
- Time and Date Settings
- Emissivity Selection
- Reflected background temperature compensation
- Transmission correction
- User selectable hot spot and cold spot, and center point on the image
- Expand/Contract Measurement Box with MIN-AVG-MAX temp High temperature alarm
- Color alarms
- User selectable backlight setting
- Graphic information display (selectable)

Software..... SmartView® full analysis and reporting
software included

Power

Batteries.....	2 Lithium-ion rechargeable smart battery packs with 5-segment LED display to show charge level.
Battery Life.....	4+ hours continuous use for each battery pack (assumes 50 % brightness of LCD)
Battery Charge Time.....	2.5 hours to full charge
AC Battery Charge.....	Ti SBC3B Two Bay Battery Charger (110 V ac to 220 V ac, 50/60 Hz, included), or in-Imager charging. Ac mains adapters included. Optional 12 V automotive charging adapter.

AC Operation	AC operation with included power supply: 110 – 220 Vac, 50/60 Hz, ac mains adapters included
Power Save	User-selectable Sleep and Power Off modes

Safety Standards

CE Directive	IEC/EN 61010-1 2nd Edition Pollution Degree 2
CAN/CSA	C22.2 No. 61010-1-04, UL STD 61010-1 (2 nd Edition)
ISA.....	82.02.01

Electromagnetic Compatibility

(EMI, RFI, EMC, RF)	Meets all applicable requirements in EN61326-1:Industrial FCC Part 15 Subpart C Sections 15.207, 15.209, 15.249
----------------------------------	--

Applies to use in Korea only.....	Class B Equipment (For Home Use Broadcasting & Communication Equipment) ^[1]
-----------------------------------	--

[1] This equipment is home use (Class B) electromagnetic wave suitability equipment that is to be used mainly at home and can be used in all areas.

Vibration	0.03 g ² /Hz (3.8 gm), 2.5 gm, IEC 68-2-6
------------------------	--

Shock	25 G, IEC 68-2-29
--------------------	-------------------

Drop	2 meter (with standard lens)
-------------------	------------------------------

Size (H x W x L)	27.7 cm x 12.2 cm x 16.7 cm (10.9 in x 4.8 in x 6.5 in)
-------------------------------	---

Weight (includes battery)	1.04 kg (2.3 lb)
--	------------------

Enclosure Rating	IP54
-------------------------------	------

Warranty	2 years
-----------------------	---------

Calibration Cycle	2 years (assumes normal operation and normal aging)
--------------------------------	---

Supported Languages	Czech, Dutch, English, Finnish, French, German, Hungarian, Italian, Japanese, Korean, Polish, Portuguese, Russian, Simplified Chinese, Spanish, Swedish, Traditional Chinese, and Turkish
----------------------------------	---

Detailed Specifications

Temperature Measurements

Temperature Range (not calibrated below -10 °C)	
Ti200, Ti300.....	-20 °C to +650 °C
Ti400.....	-20 °C to +1200 °C
Accuracy.....	±2 °C or 2 % (whichever is greater) at 25 °C ambient
On-screen emissivity correction.....	all models
On-screen reflected background temperature compensation.....	all models
On-screen transmission correction.....	all models

Imaging Performance

Image Capture Frequency.....	9 Hz or 60 Hz refresh rate depending on model variation
Detector Type: Focal Plane Array, uncooled microbolometer	
Ti400.....	320 X 240
Ti300.....	240 X 180
Ti200.....	200 X 150
Thermal Sensitivity (NETD)	
Ti400, Ti300.....	≤0.05 °C at 30 °C target temp (50 mK)
Ti200.....	≤0.075 °C at 30 °C target temp (75 mK)
Total pixels	
Ti400.....	76,800
Ti300.....	43,200
Ti200.....	30,000
Infrared spectral band.....	7.5 µm to 14 µm (long wave)

Visual (Visible Light) Camera

Type.....	Industrial performance 5.0 megapixel
Minimum parallax alignment with standard IR lens.....	~60 cm (~24 in)

Standard Infrared Lens

Field of View.....	24 ° x 17 °
Spatial Resolution (IFOV)	
Ti400.....	1.31 mRad
Ti300.....	1.75 mRad
Ti200.....	2.09 mRad
Minimum Focus Distance.....	15 cm (6 in)

Optional telephoto infrared lens

Field of View	12 ° x 9 °
Spatial Resolution (IFOV)	
Ti400	0.65 mRad
Ti300	0.87 mRad
Ti200	1.05 mRad
Minimum Focus Distance	45 cm (18 in)

Optional wide-angle infrared lens

Field of View	46 ° x 34 °
Spatial Resolution (IFOV)	
Ti400	2.62 mRad
Ti300	3.49 mRad
Ti200	4.19 mRad
Minimum Focus Distance	15 cm (6 in)

Focus Mechanism

LaserSharp™ Auto Focus System	all models
Advanced Manual Focus	all models

Image Presentation

Standard Palettes	Blue-Red, Grayscale, Inverted Grayscale, High Contrast, Amber, Inverted Amber, Hot Metal, Ironbow
Ultra Contrast™ Palettes	Blue-Red Ultra, Grayscale Ultra, Inverted Grayscale Ultra, High Contrast Ultra, Amber Ultra, Inverted Amber Ultra, Hot Metal Ultra, Ironbow Ultra

Level and Span

- Smooth Auto-Scaling and Manual scaling of level and span
- Fast auto toggle between manual and auto modes
- Fast auto rescale in manual mode
- Minimum Span (in manual mode)2.0 °C (3.6 °F)
- Minimum span (in auto mode).....3.0 °C (5.4 °F)

IR-Fusion® Technology

- Automatically aligned (parallax corrected) visual and infrared
- Picture-In-Picture (PIP) infrared
- Full screen infrared
- AutoBlend™ mode
- Full screen visible
- Color alarms (temperature alarms) High temperature, low temperature, and isotherm (user selectable)

Image and Data Storage

Image Capture, Review, Save Mechanism	One-handed image capture, review, and save capability
Storage Medium	
Micro SD Memory Card	includes 4 GB memory card to store at least 2000 fully radiometric (.is2) IR and linked visual images each with 60 seconds voice annotations or 5000 basic (.bmp or .jpg) images
Internal on-board flash memory	4 GB available for storage
USB	direct download with USB-to-PC connection

Note

The addition of IR-PhotoNotes or other saved items can vary the total number of images that can be stored on the SD memory card.

File Formats.....	Non-Radiometric (.bmp, .jpg) or Fully-Radiometric (.is2) No analysis software required for Non-Radiometric (.bmp, .jpg) files
Export File Formats with SmartView® Software	JPEG, JPG, JPE, JFIF, BMP, GIF, DIP, PNG, TIF, TIFF
Memory Review	Thumbnail view navigation and review selection

Productivity Features

- Voice Annotation (60 seconds maximum recording time for each image. Reviewable playback on Imager.)
- IR-PhotoNotes™
- WIFI connectivity
- Streaming video
- Remote control and operation

