

THIS IS A C.A.D. GENERATED DRAWING
DO NOT MAKE MANUAL REVISIONS TO MASTER.

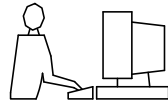

* UNLESS OTHERWISE SPECIFIED TOLERANCES
ON DECIMAL IS: ANGLE $\pm 1^\circ$
UNIT: MM .XX ± 0.35

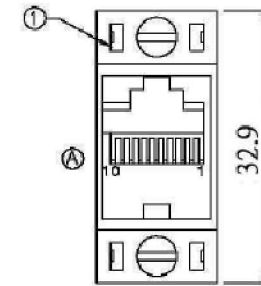
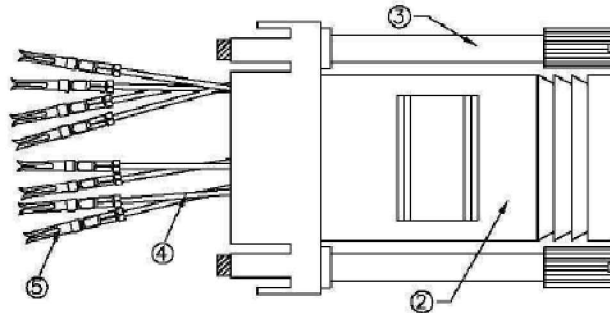
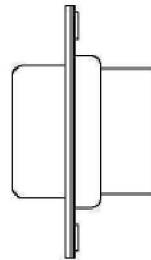
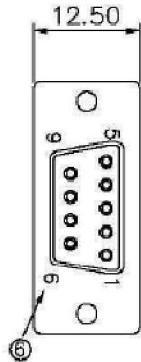
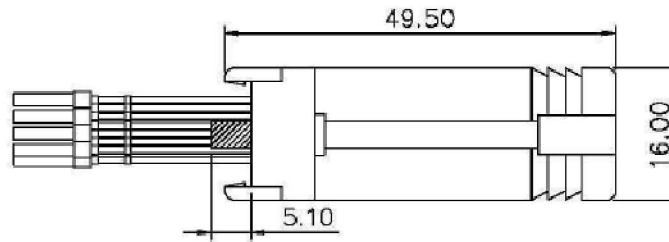
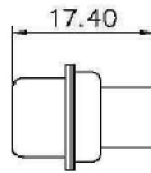

ORDERING INFORMATION:

SIZE	P/N - KITTED	PRODUCT CODE
9-WAY		

ROHS Compliant

POSITION	COLOUR
1	Black
2	Yellow
3	Orange
4	Red
5	Green
6	Brown
7	Grey
8	Blue

NO.	Name	Description	Q'ty
1	Conn	Modular jack 10P8C Female,ABS,Black,Gold Flash Contact	1
2	Hood	Metallized Hood	1
3	Screw	#4-40UNC Thumb Screw Nickel Plated	2
4	Wire	UL1061,26AWG,7 Stand Lead Wire	8
5	Terminal	D-SUB Female Terminal,Copper,Gold Plated	8
6	Conn	Crimp Wire D-SUB Female 9pin Black Insulator	1

THESE DRAWINGS AND SPECIFICATIONS ARE THE PROPERTY OF MH CONNECTORS LTD. AND SHALL NOT BE REPRODUCED, COPIED OR USED AS THE BASIS FOR THE MANUFACTURE OR SALE OF APPARATUS WITHOUT WRITTEN PERMISSION.

DRAWN Johnny	DATE 02-27-17
APPROVED Victor	DATE 02-27-17



THIS SERIES FULLY CONFORMS TO THE EUROPEAN UNION DIRECTIVES 2002/95/EC AND 2002/96/EC FOR RoHS COMPLIANCY.

SCALE	SHEET OF 1 OF 1	REV: 5.0
-------	--------------------	-------------

DRAWING No