



## Datasheet

### RS PRO 2 Cell 1300 mA Battery Pack Charger for Lithium-Ion Batteries, AUS, EURO, UK & USA Plug

Stock number: 173-5587

EN



## Technical Drawing:

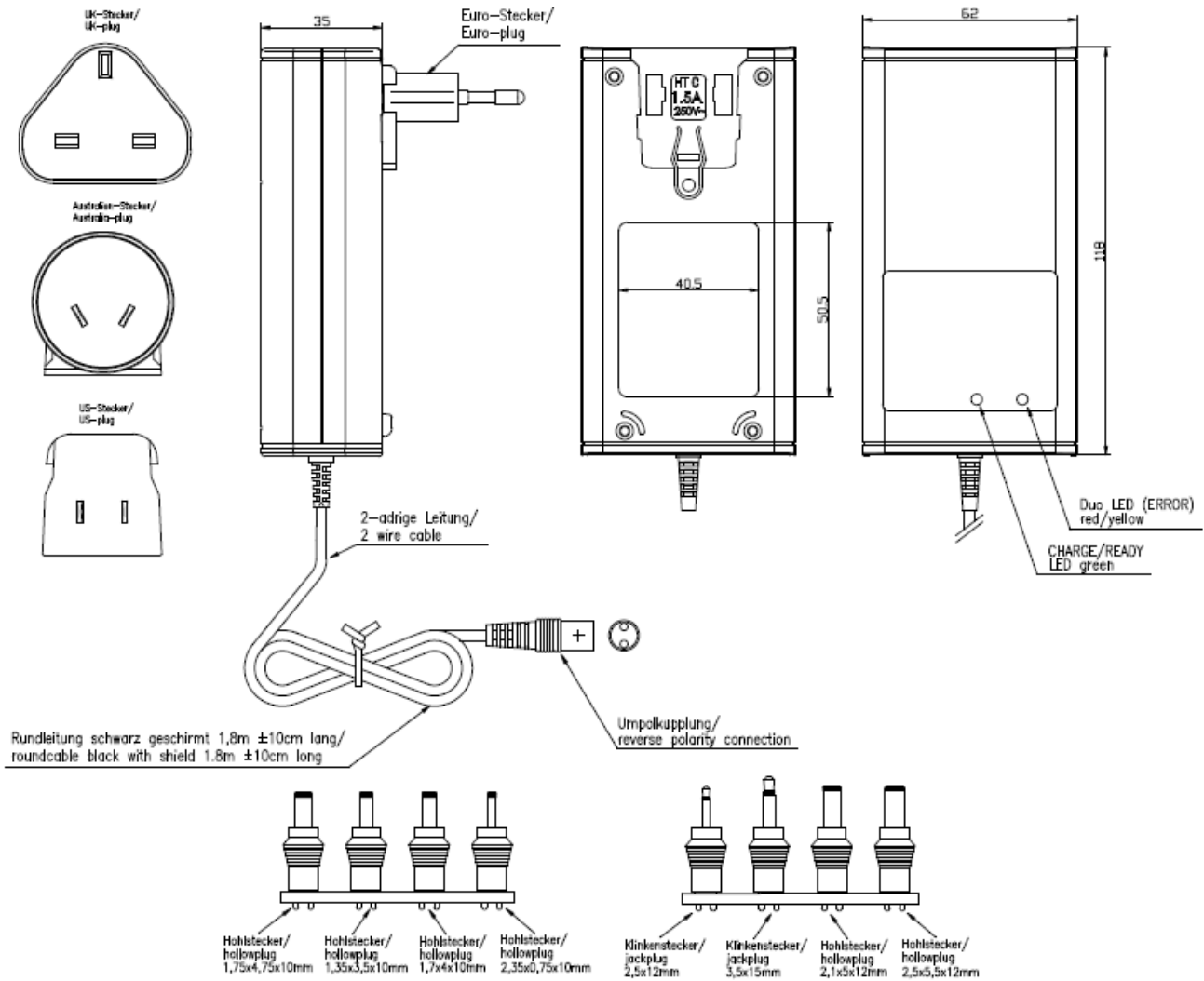

## Charging Indicators:

No Battery	LEDs Off
Charging	Green LED Flashes
Battery Fully Charged	Green LED Lights Steady
Error	Red LED Flashes

### Electrical Specifications:

<b>Chemistry Charged</b>	Lithium-Ion	<b>Charging Regime</b>	CC-CV
<b>Input Voltage</b>	100-240 V $\pm$ 10%, 50/60 Hz	<b>Primary Electrical Protection</b>	Fuse 1.6 A
<b>Nominal Output Voltage</b>	7.4 V	<b>Secondary Electrical Protection</b>	Short Circuit and Wrong Polarity
<b>Nominal Output Current</b>	1300 mA $\pm$ 10%	<b>No Load Output Voltage</b>	Approx. 8 V to 16.8 V
<b>Number of Cells Charged</b>	2	<b>Electric Strength</b>	4 kV Primary/Secondary
<b>Charge End Voltage</b>	8.4 V $\pm$ 1%	<b>Protection Class</b>	II
<b>Charge End Current</b>	400 mA $\pm$ 10%	<b>Stand-By Power</b>	< 0.8 W
<b>Pre-Charge Current</b>	50 mA to 500 mA $\pm$ 20%	<b>Leakage Current</b>	< 100 $\mu$ A
<b>Pre-Charge Voltage</b>	2.5 V to 3 V per cell	<b>Safety Timer</b>	No
<b>Restart Voltage</b>	3.9 V to 4.1 V per cell	<b>Approvals</b>	CE
<b>Reverse Current without AC</b>	< 500 $\mu$ A at 4.2 V per cell	<b>Standards</b>	IEC/EN60335-2-29, UL1310

### Physical Specifications:

<b>Case</b>	Plug-In Housing	<b>Output Connectors</b>	Push On
<b>Case Material</b>	PC Plastic UL94V-0, black	<b>Plug Type</b>	UK, Euro, US, Australia
<b>PCB Material</b>	FR4	<b>Weight</b>	320 g
<b>Dimensions</b>	118 mm x 62 mm x 35 mm	<b>Operating Temperature</b>	0°C to 40°C
<b>Rating Plate (Front and Back)</b>	Silver label with black printing	<b>Storage Temperature</b>	-25°C to +70°C