

- └ Single-Row
- └ ZZ: With Two Shielded

Boundary Dimensions (mm)				Basic Load Ratings (kN)		Limiting Speeds (min ⁻¹)		Bearing Numbers	NSKHPS
<i>d</i>	<i>D</i>	<i>B</i>	<i>r</i> min.	<i>C_r</i>	<i>C_{0r}</i>	Grease	Oil		
40	90	23	1.5	43	24	9000	-	6308ZZ &	NSKHPS

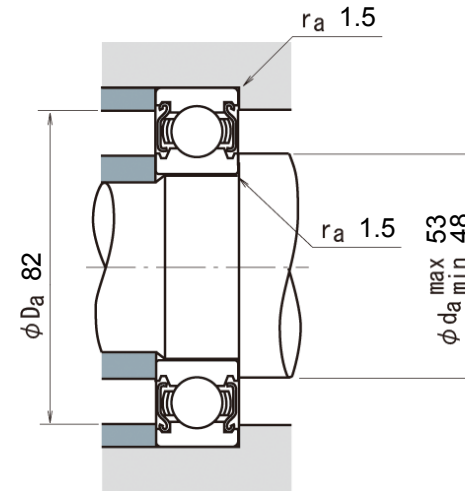
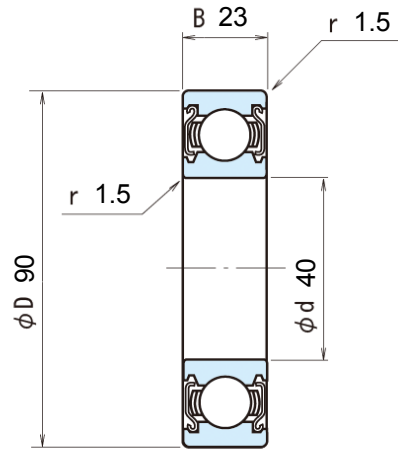

Factor	Mass (kg) approx.
f_0	
13.2	0.636