

Datasheet

LED Lamp

RS ITEM NO 211-184

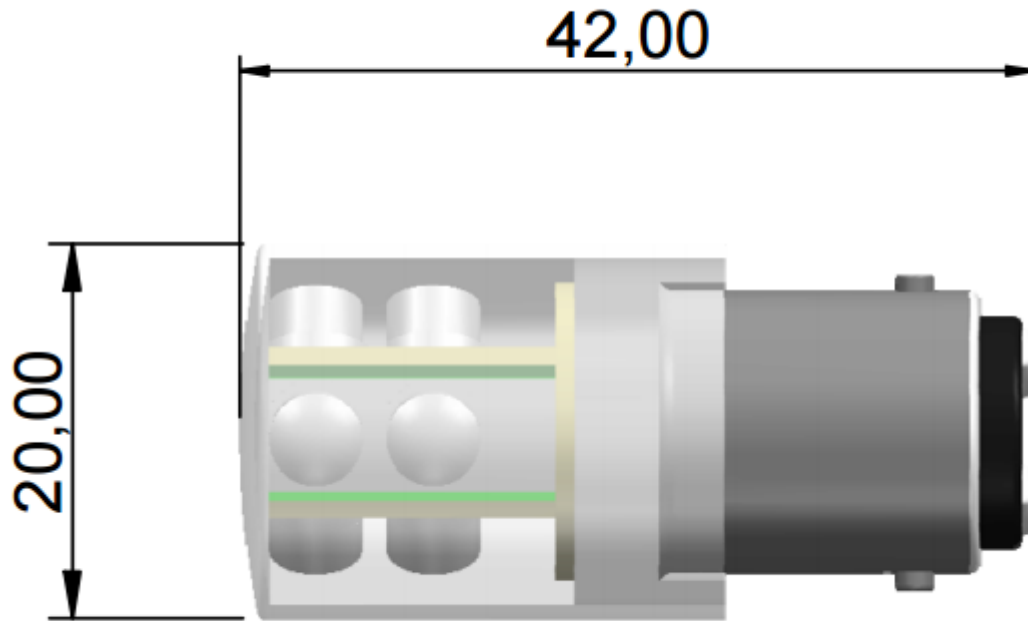

LED/Multiled	LED	Optimum voltage (V)	130Vac	Intensity	150mcd
Mounting Size	13mm	Rectifier		Reverse Voltage	
Mounting Finish		AC current	20mA (max)	360 Illumination for Stack Light or Tower Light	
Protection		DC current			
Mount Holder	BA15D	Voltage Tolerance(%)	10%		
Chip Qty	6	Optimum temperature (°C)	-30°C...+60°C		
Indicator colour	Green	Storage temperature (°C)	-30°C...+60°C		
Wavelength (nm)	530nm	Contact Tab x 2	BA15D BaseCap		



Dimension in mm (typical), not to scale.
We reserve the right to make changes without further notice to this product to improve reliability, function or design.