

Round LED

5mm, Red

multicomp **PRO**

RoHS
Compliant



Features

- Low power consumption
- Excellent product quality and reliability
- Lead-free device.

Applications

- Electronic signs and signals
- Bright ambient lighting conditions
- Backlights.
- General purpose indicators

Device Selection Guide

Part No.	Chip		Lens color
MP008545	Material	Emitted color	Red Diffused
	AlGaInP	Red	

Absolute Maximum Ratings: (T_A = 25°C)

Parameter	Symbol	Value	Unit
Power Dissipation	P _D	50	mW
Forward Current	I _F	30	mA
Peak Forward Current* ¹	I _{FP}	100	mA
Reverse Voltage	V _R	5	V
Operating Temperature	T _{OPR}	-40 to +85	°C
Storage Temperature	T _{STG}	-40 to +85	°C
Soldering Temperature* ²	T _{SOI}	260°C For 5 Seconds	

Notes:

*1: Pulse width ≤ 0.1ms, Duty cycle ≤ 1/10

*2: 1.6mm below package base.

Newark.com/multicomp-pro
Farnell.com/multicomp-pro
Element14.com/multicomp-pro

multicomp **PRO**

Round LED

5mm, Red

multicomp PRO

Electrical / Optical Characteristics at T _A = 25°C						
Parameter	Symbol	Min.	Typ.	Max.	Unit	Condition
Forward Voltage	V _F	1.8	2	2.6	V	I _F = 20mA
Reverse Current	I _R	-	-	10	uA	V _R =5V
Dominant Wavelength	λ _d	620	625	630	nm	I _F =20mA
Peak Wavelength	λ _p	-	635	-	nm	
Spectral Line Half-Width	Δλ	-	15	-	nm	
Luminous Intensity	I _V	3800	5700	8000	mcd	
Power Angle	2θ _{1/2}	-	50	-	Deg.	

Remarks:

If special sorting is required (e.g. binning based on forward voltage, luminous intensity, or dominant wavelength), the typical accuracy of the sorting process is as follows:

1. Dominant Wavelength: +/-1nm
2. Chromatic Coordinates: +/-0.01
3. Luminous Intensity: +/-15%
4. Forward Voltage: +/-0.1V
5. The design and working current for LED is not less than 2mA.

Dimensions

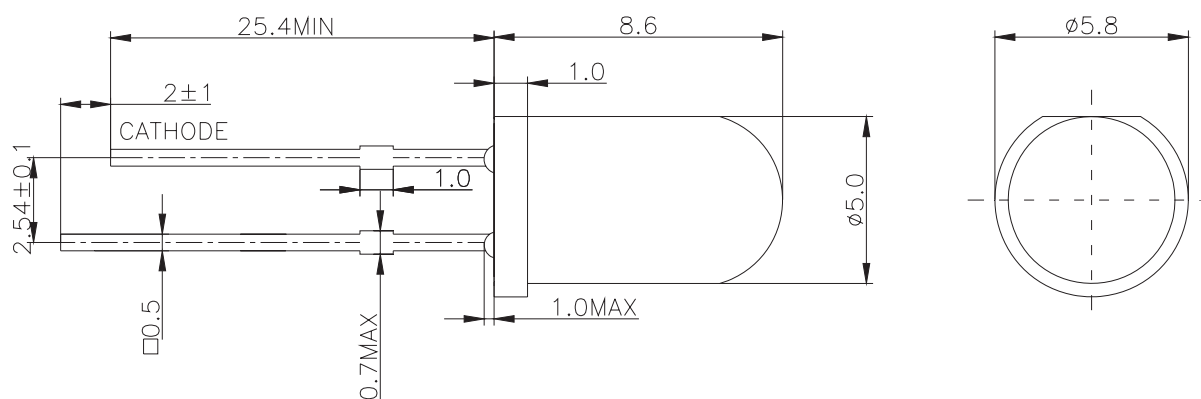

Notes:

1. Tolerance is ±0.25 unless otherwise noted.
2. Lead spacing is measured where the leads emerge from the package.
3. Specifications are subject to change without notice.

Dimensions : Millimetres

Round LED

5mm, Red

Typical Electrical/Optical Characteristics Curves (Ta=25°C Unless Otherwise Noted)

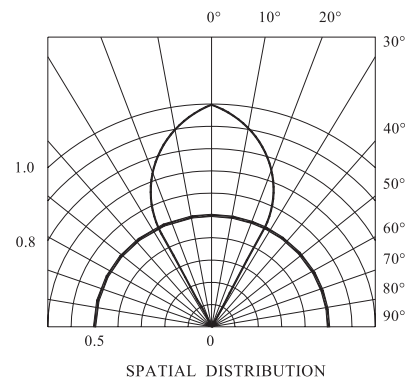
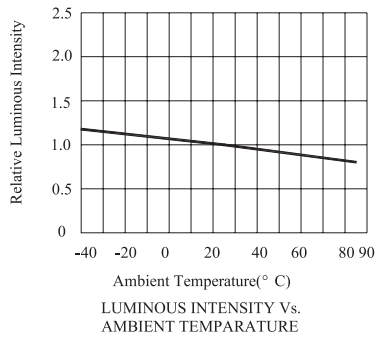
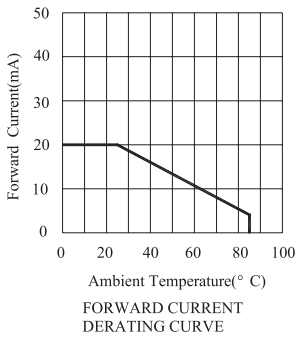
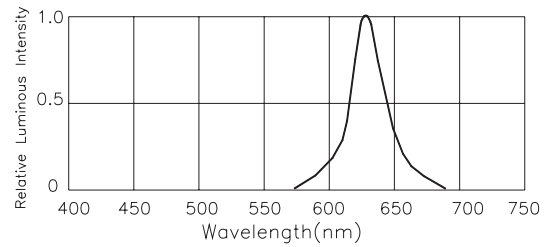
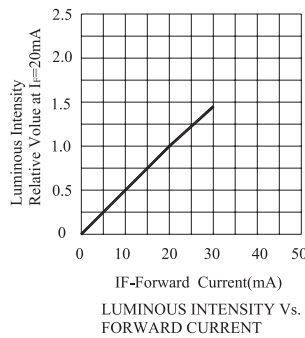
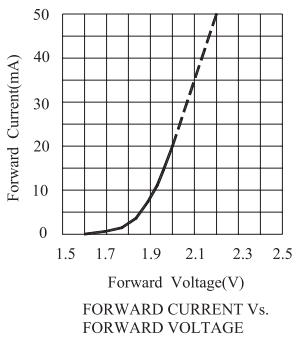

Part Number Table

Description	Part Number
Round LED, Red, 635nm, 50°, 5700mcd, Through hole	MP008545

Important Notice : This data sheet and its contents (the "Information") belong to the members of the AVNET group of companies (the "Group") or are licensed to it. No licence is granted for the use of it other than for information purposes in connection with the products to which it relates. No licence of any intellectual property rights is granted. The Information is subject to change without notice and replaces all data sheets previously supplied. The Information supplied is believed to be accurate but the Group assumes no responsibility for its accuracy or completeness, any error in or omission from it or for any use made of it. Users of this data sheet should check for themselves the Information and the suitability of the products for their purpose and not make any assumptions based on information included or omitted. Liability for loss or damage resulting from any reliance on the Information or use of it (including liability resulting from negligence or where the Group was aware of the possibility of such loss or damage arising) is excluded. This will not operate to limit or restrict the Group's liability for death or personal injury resulting from its negligence. Multicomp Pro is the registered trademark of Premier Farnell Limited 2019.