



ENGLISH

Datasheet

Stock No: 401-670

RS PRO Panel Mount Toggle Switch

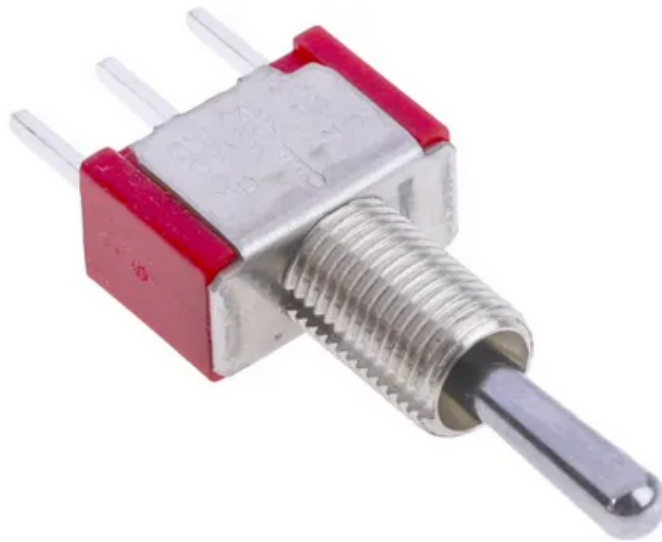

Feature:

ON-OFF-ON

10.41 high

8.89 high, keyway (thd std)

PC thru-hole

Silver

EPOXY (std)

RoHS & Lead Free

Code symbol:

1MS3

T1

B1

M2

Q

E

S

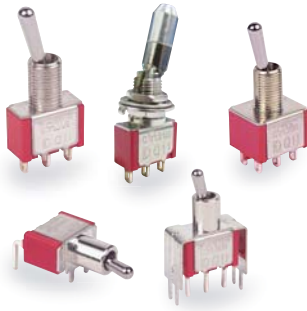

SPECIFICATIONS

CONTACT RATING: Dependent upon contact material, see page 11.

MECHANICAL LIFE: 40,000 make-and-break cycles.

CONTACT RESISTANCE: 10mΩ max. (initial value) @ 2-4VDC
100mA for both silver and gold plated contacts.

INSULATION RESISTANCE: 1,000 MΩ min./1000VDC

DIELECTRIC STRENGTH: 1,000 Vrms min. @ sea level. (initial value)

OPERATING TEMPERATURE: -40°C to 85°C.

MATERIALS

CASE: Diallyl phthalate (DAP) (UL94v-0).

ACTUATOR: Brass, chrome plated.

BUSHING: Brass, nickel plated.

HOUSING: Stainless steel.

SWITCH SUPPORT: Brass, tin plated.

CONTACT / TERMINALS: Copper with silver or gold plated.

(See page 11)

MODEL NO.	ACTUATOR	BUSHING	TERMINAL TYPE	TERMINAL PLATING	SEAL	RoHS SOLDERING
SP				Q Silver R Gold C Gold over silver	E EPOXY (std) N NO EPOXY	S RoHS & Lead Free
1MS1 ON-NONE-ON	T1 10.41 high					
1MS2 ON-NONE-(ON)	T2 5.08 high					
1MS3 ON-OFF-ON	T3 13.97 high					
1MS4 (ON)-OFF-(ON)	T4 16.26 high					
1MS5 ON-OFF-(ON)	T5 21.34 high					
	T9 21.3 high, Plastic					
	T7 12.37 high **		B1 8.89 high, keyway (thd std)		M1 Solder lug	
	T8 17.56 high **		B2 8.89 high, keyway (non-thd)		M2 PC thru-hole	
	T88 17.5 high ***		B3 7.10 high, keyway (thd)		M3 Quick connect	
DP			B4 7.10 high, keyway (non-thd)		M51 18.70 high, wire wrap	
1MD1 ON-NONE-ON			B7 8.89 high, flat (thd std)		M52 24.20 high, wire wrap	
1MD2 ON-NONE-(ON)			B8 8.89 high, keyway (metric thd)		M53 10.55 high, wire wrap	
1MD3 ON-OFF-ON	<u>Anti-rotation</u>		B11 7.55 high, keyway (thd std) ****		M54 26.97 high, wire wrap	
1MD4 (ON)-OFF-(ON)	T6 12.30 high		B12 7.55 high, keyway (non-thd) ****		M6 Right angle, PC thru-hole	
1MD5 ON-OFF-(ON)	T61 21.0 high		B13 11.38 high, keyway (15/32 bushing)		M6N Right angle, Snap-in, PC thru-hole	
1MD6 ON-ON-ON	T62 13.49 high, With cap		B15 7.55 high, flat (thd std) ****		M7 Vertical right angle, PC thru-hole	
1MD7 (ON)-ON-(ON) ▲	T63 6.35 high		B16 7.55 high, flat (non-thd) ****			
1MD8 ON-ON-(ON) ▲	<u>Locking lever</u>		B17 3.50 high, keyway, (thd)			
	TL1 16.00 high		B18 11.38 high, keyway (15/32 bushing)		<u>V-bracket</u>	
3P	TL2 16.26 high		B20 11.38 high, keyway (15/32 bushing)		VS2 11.68 high	
1M31 ON-NONE-ON	TL3 17.28 high				V2N 11.68 high, Snap-in.	
1M32 ON-NONE-(ON)			<u>High torque</u>		VS3 16.00 high	
1M33 ON-OFF-ON			B5 7.52 high, flat		VS4 11.68 high	
1M34 (ON)-OFF-(ON)			B6 8.00 high, keyway		VS5 16.00 high	
1M35 ON-OFF-(ON)						
4P			<u>Locking</u>			
1M41 ON-NONE-ON			B25 8.00 high, keyway, (thd) *			
1M42 ON-NONE-(ON)			B26 8.00 high, keyway, (non-thd) *			
1M43 ON-OFF-ON						
1M44 (ON)-OFF-(ON)			<u>Splash proof</u>			
1M45 ON-OFF-(ON)			B9 7.52 high, flat, (thd)			
1M46 ON-ON-ON			B14 11.90 high, flat, (15/32 bushing)			
1M47 (ON)-ON-(ON) ▲			B52 11.70 high, flat, (15/32 bushing) ***			
1M48 4P ON-ON-(ON) ▲						

▲ Please confirm the availability before order.

* Only available for Locking lever.
** Only available for 15/32 bushing.
*** T88 actuators are only available with B52 bushing
**** Only available for Anti-rotation lever.

EXAMPLE: 1MS1T1B1M1QES

SWITCH FUNCTION

NO. POLES	UL/CSA MODEL NO.	MODEL NO.	SWITCH FUNCTION			CONNECTED TERMINALS / SCHEMATIC		
			POS.1	POS.2	POS.3	POS.1	POS.2	POS.3
SP	Q1111	1MS1	ON	NONE	ON		N/A	2-1
	Q1112	1MS2	ON	NONE	(ON)			
	Q1113	1MS3	ON	OFF	ON			
	Q1114	1MS4	(ON)	OFF	(ON)			
	Q1115	1MS5	ON	OFF	(ON)			
DP	Q1121	1MD1	ON	NONE	ON		N/A	2-1,5-4
	Q1122	1MD2	ON	NONE	(ON)			
	Q1123	1MD3	ON	OFF	ON			
	Q1124	1MD4	(ON)	OFF	(ON)			
	Q1125	1MD5	ON	OFF	(ON)			
	Q1126	1MD6	ON	ON	ON			
	▲ Q1127	1MD7	(ON)	ON	(ON)			
	▲ Q1128	1MD8	ON	ON	(ON)			
3P	Q1131	1M31	ON	NONE	ON		N/A	2-1,5-4,8-7
	Q1132	1M32	ON	NONE	(ON)			
	Q1133	1M33	ON	OFF	ON			
	Q1134	1M34	(ON)	OFF	(ON)			
	Q1135	1M35	ON	OFF	(ON)			
4P	Q1141	1M41	ON	NONE	ON		N/A	2-1,5-4,8-7,11-10
	Q1142	1M42	ON	NONE	(ON)			
	Q1143	1M43	ON	OFF	ON			
	Q1144	1M44	(ON)	OFF	(ON)			
	Q1145	1M45	ON	OFF	(ON)			
	Q1146	1M46	ON	ON	ON			
	▲ Q1147	1M47	(ON)	ON	(ON)			
	▲ Q1148	1M48	ON	ON	(ON)			

() = MOMENTARY

▲ Please confirm the availability before order.

▼ POLE OPTIONS

1M
Toggle Switches

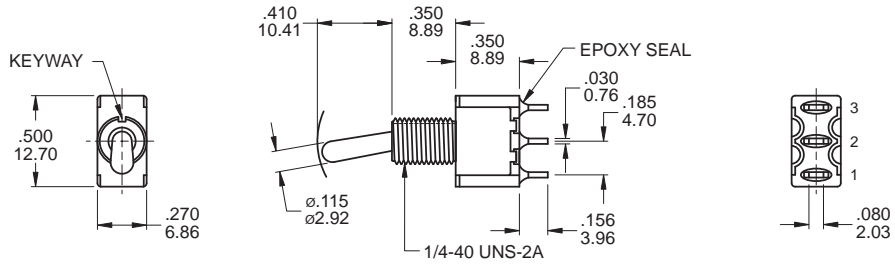

SPDT

Model name. 1MS1T1B1M1QES

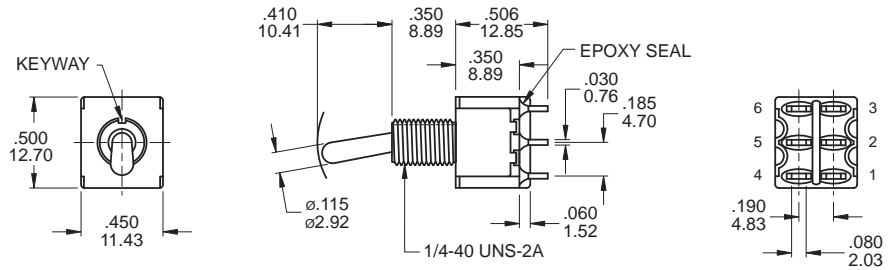

DPDT

Model name. 1MD1T1B1M1QES

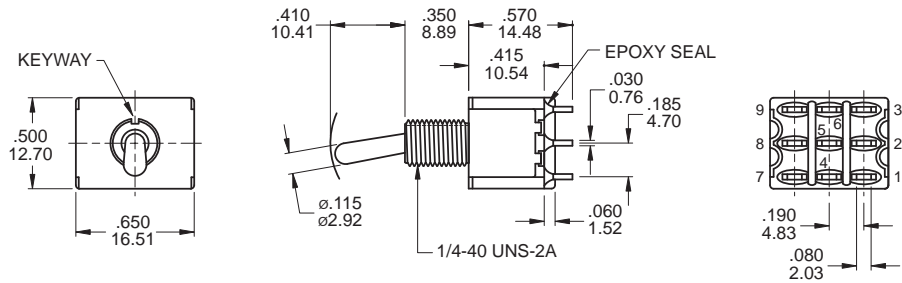

3PDT

Model name. 1M31T1B1M1QES

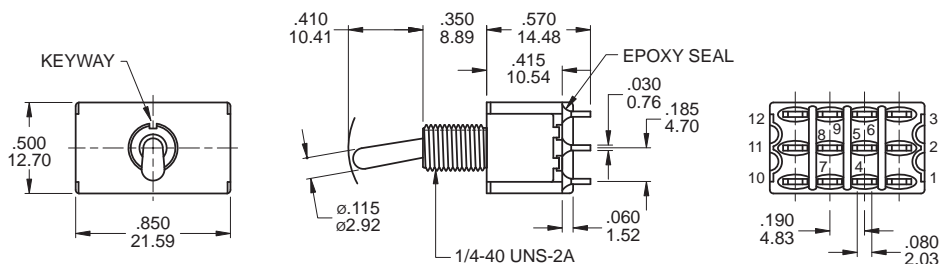

4PDT

Model name. 1M41T1B1M1QES

▼ 3-WAY SWITCH

SINGLE POLE, 3 POSITION

Model No.	POS 1	POS 2	POS 3
1MD6	ON	ON	ON
Term. Comm.	2-3,5-6	2-3,5-4	2-1,5-4

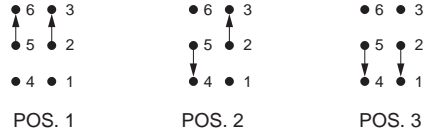
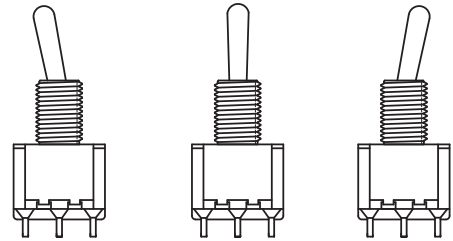
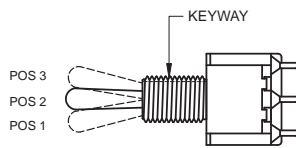

DOUBLE POLE, 3 POSITION

Model No.	POS 1	POS 2	POS 3
1M46	ON	ON	ON
Term. Comm.	2-3,5-6 8-9,11-12	2-3,5-4 8-9,11-10	2-1,5-4 8-7,11-10

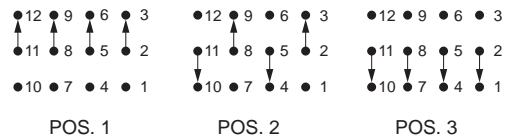
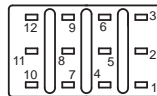

* Diagram of the 3-way switch wiring

▼ ACTUATOR OPTIONS

T1 STD

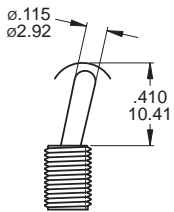

T2

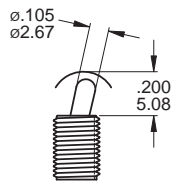

T3

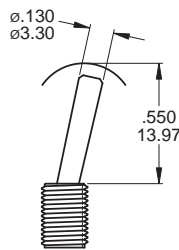

T4

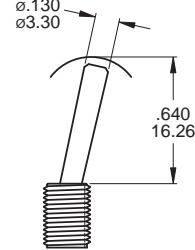

T5

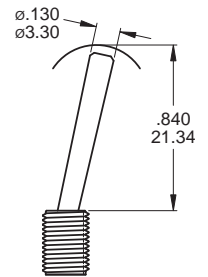

T1~T5 Actuator are shown with Bushing B1(standard) and available with Terminal M1,M2.

Note: For B3 Bushing: +.070inch(1.78mm)

For B6 Bushing: -.020inch(0.51mm)

For B1/B2 Bushing with Terminal M6, M7, VSX: -.016inch(0.40mm)

T88B52

SPLASH PROOF

* Standard function is SPDT, can only applicable with terminal M1 and M2.

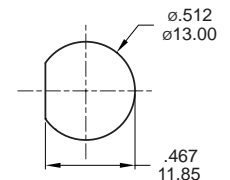
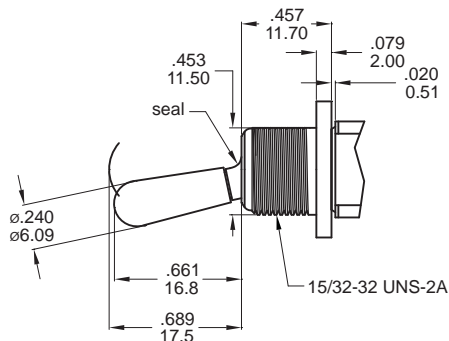
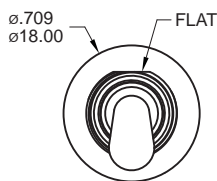

PANEL MOUNTING
Without locking ring (Flat)

Note: T6, T61, T62, T63 can only be use with B11, B12, B15, B16 bushing.

T6 FLATTED WITH ANTI-ROTATION

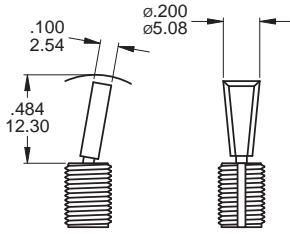

T61

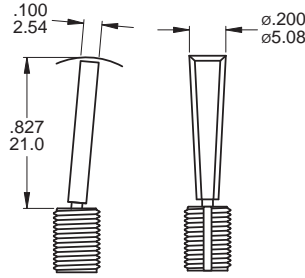

T63

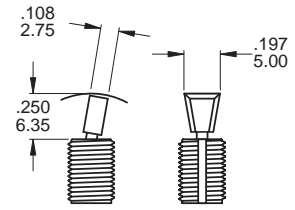

T62 WITH BLACK CAP(STD)

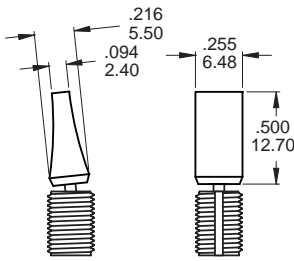

Plastic Color :

ITEM NO	COLOR
1	White
3	Red
4	Orange
5	Yellow
6	Green
7	Blue
9	Gray

* Except standard color, for other colors information please consult sales representativity.

EXAMPLE:

1MS1T62M1QES (BLACK STD)

1MS1T62□M1QES

□ Cap Color

T7

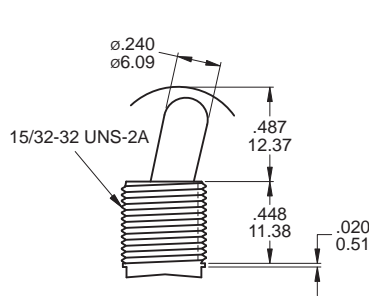

Shown with B13 bushing.
Use with Bushing B18 and B20, the lever is antirotation and the length of lever is 13.00mm.

T8

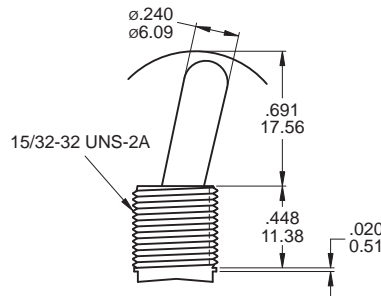

Shown with B13 bushing.
Use with Bushing B18 and B20, the lever is antirotation and the length of lever is 18.00mm.

T9□

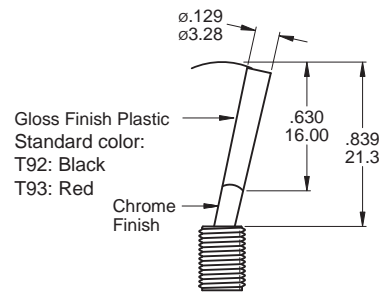

Standard for B1 and B2 bushing.

TL1B25 THD STD B26 NON-THD

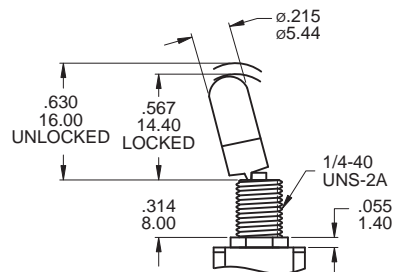

TL2B25 THD STD B26 NON-THD

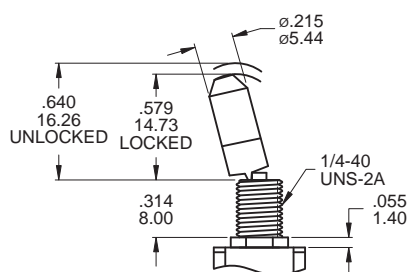

TL3B25 THD STD B26 NON-THD

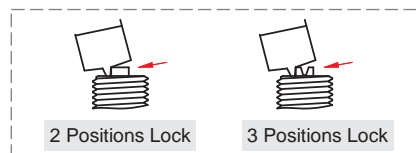
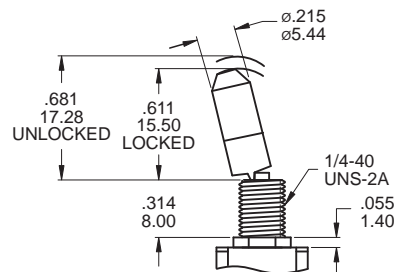

▼ BUSHING OPTIONS

B1 THD STD
B2 NON-THD

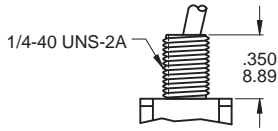
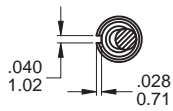

For terminal M6, M7 and VS2-5:
-.015inch(0.39mm)

B3 THD
B4 NON-THD

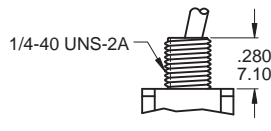
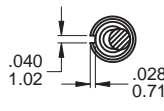

B4 is standard for terminal M6, M7
and VS2-5.

B5 HIGH TORQUE

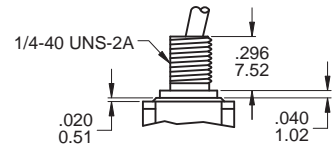
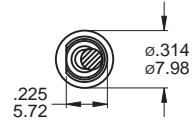

B6 HIGH TORQUE

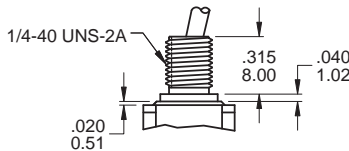
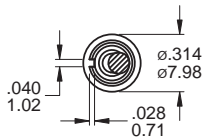

B7 THD STD

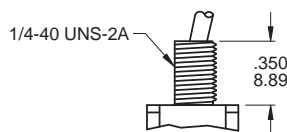
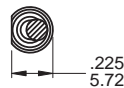

B8 METRIC THD

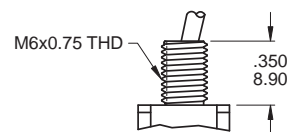
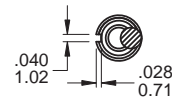

B9 SPLASH PROOF

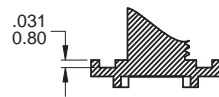
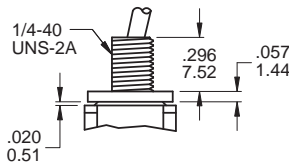
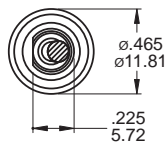
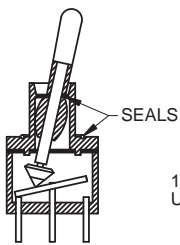

O-RING
Model name. CP-1TEB

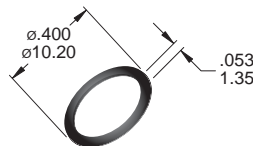

B9 bushing with O-Ring

B11 THD STD
B12 NON-THD

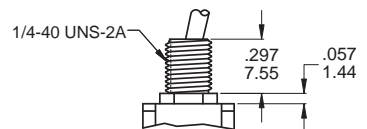
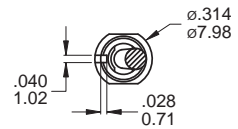

Only available for actuator T6~T63.

B15 THD STD
B16 NON-THD

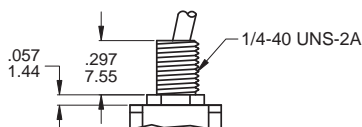
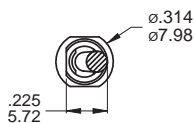

Only available for actuator T6~T63.

B17

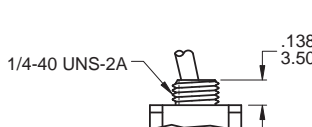
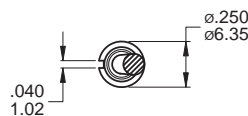

Only available for actuator T2 and the
length of lever is .311inch(7.90mm).
Standard for terminal M1, M2

B13

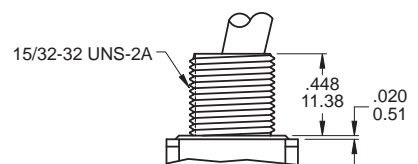
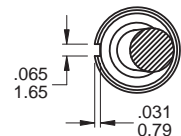

Available with actuator T7 and T8 only.
Bear strength from top of actuator is up
to 10 kg, and 15kg from aside.

B14 SPLASH PROOF

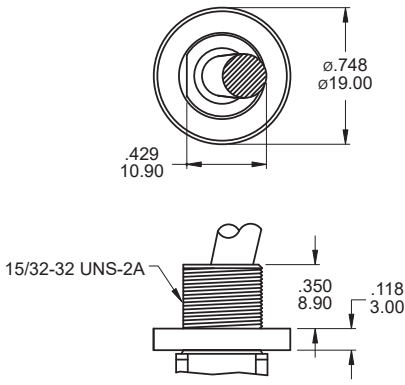

Available with actuator T7 and T8 only.

B18 *

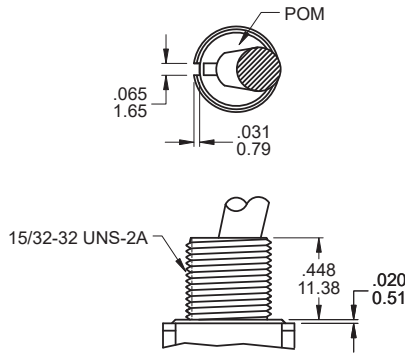

Available with actuator T7 and T8 only.
(with Plastic (POM) Insert)

B20 *

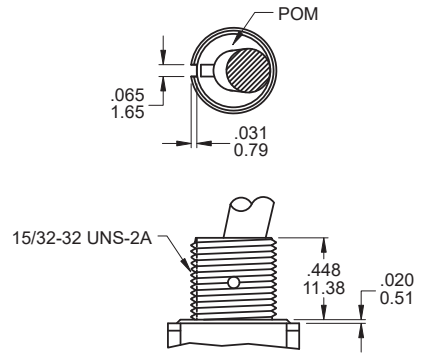

Available with actuator T7 and T8 only.
(with Plastic (POM) Insert)

* Bear strength from top of actuator is up to 20 kg, and 15kg from aside.

▼ TOGGLE CAP



Model name. MCP-1T12 (std.)
Note: Only available for actuator T1

CAP Color :

ITEM NO	COLOR
1	White
2	Black (Std)
3	Red
5	Yellow
6	Green
7	Blue
9	Gray

* Except standard color, for other colors information please consult sales representativity.

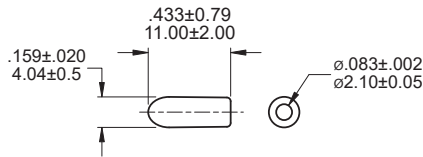

EXAMPLE: - T1

Model name.

Cap color

0 No hardware

5 Standard hardware

▼ PANEL MOUNTING

1/4 IN BUSHING

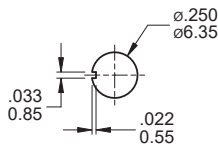

Without locking ring (Keyway)

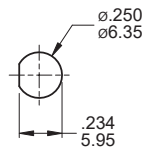

Without locking ring (Flat)

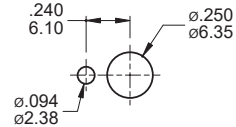

With standard locking ring.

METRIC BUSHING

Note: For B8 bushing.

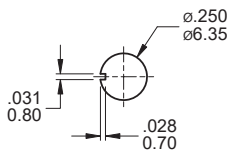

Without locking ring (Keyway)

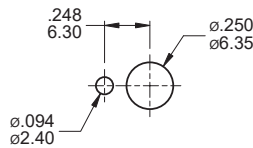

With standard locking ring.

15/32 IN BUSHING

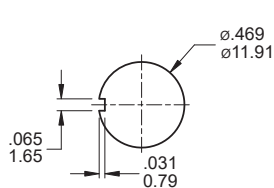

Without locking ring (Keyway)

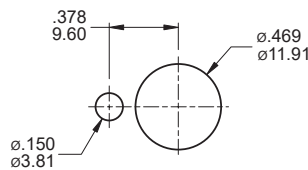

With standard locking ring.

SPLASH PROOF BUSHING

Note: For B14 bushing.

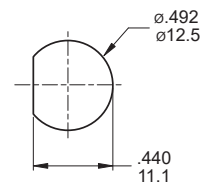

Without locking ring (Flat)

1M Series

Miniature Toggle Switches



Toggle Switches

▼ TERMINAL OPTIONS

M1 Solder lug

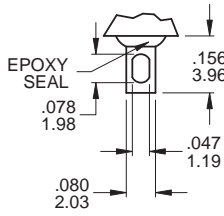

.030inch(0.76mm) THK.

M2 PC Thru-hole

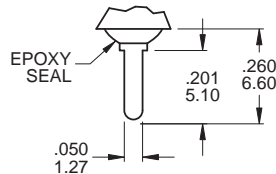

.030inch(0.76mm) THK.

M3 Quick connect

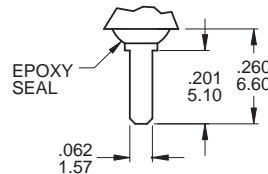

.030inch(0.76mm) THK.

M5 Wire Wrap

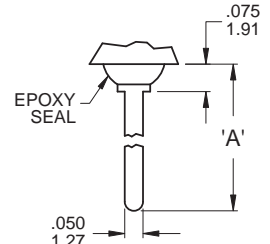

.030inch(0.76mm) THK.

▼ OTHER TERMINAL OPTIONS

M6 Right angle P.C. Mount

M7 Vertical right angle P.C. Mount

VS2 Vertical bracket P.C. Mount

VS3 Vertical bracket P.C. Mount

VS5 Vertical bracket P.C. Mount

M6N Right angle P.C. Mount

with snap-in bracket

V2N Vertical bracket P.C. Mount

with snap-in bracket

OPTION CODE	DIM. 'A'
M51	.736 (18.70)
M52	.953 (24.20)
M53	.415 (10.55)
M54	1.062 (26.97)

M6

(M6N - Snap-in)

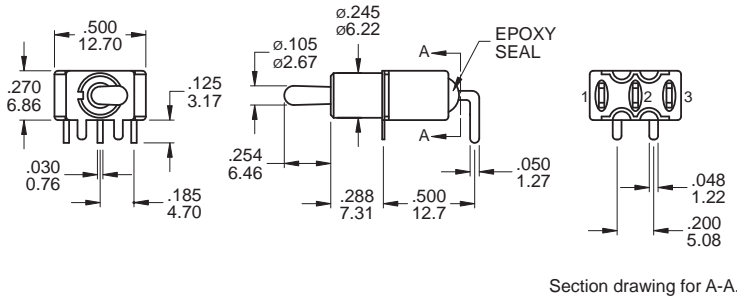

Model name. 1MS1T2B4M6QES

PCB MOUNTING

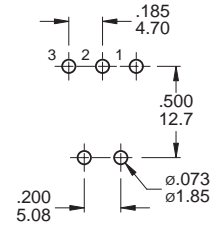

SPDT

M6

(M6N - Snap-in)

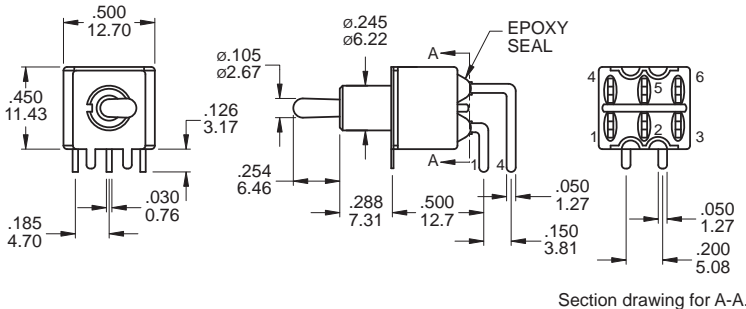

Model name. 1MD1T2B4M6RES

PCB MOUNTING

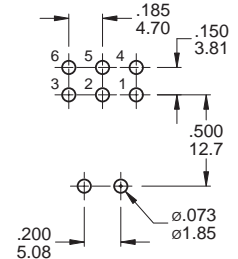

DPDT

M7

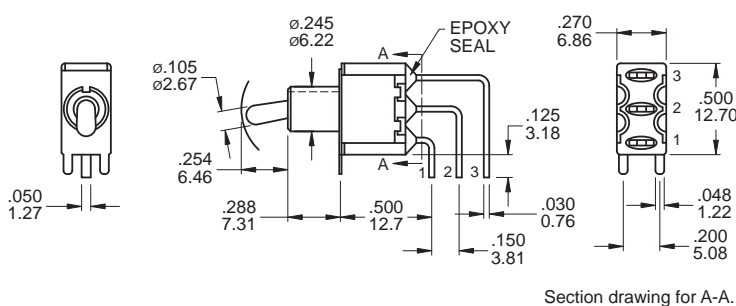
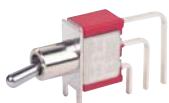

Model name. 1MS1T2B4M7QES

PCB MOUNTING

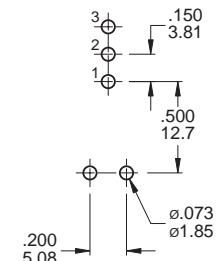

SPDT

M7

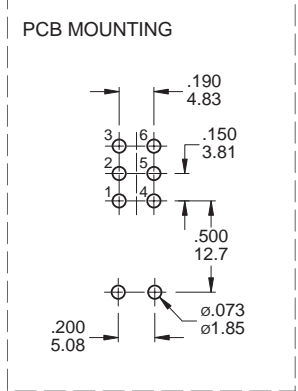
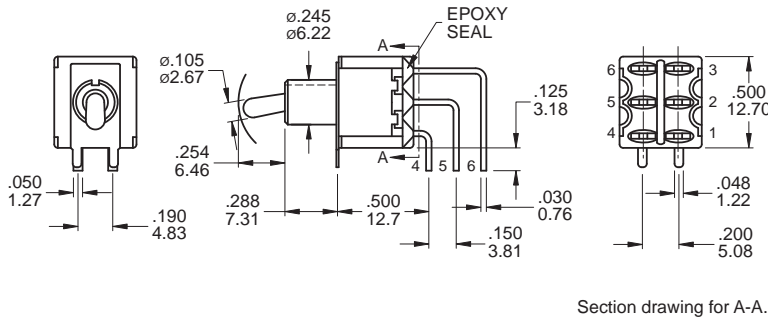

DPDT

Model name. 1MD1T2B4M7QES

M7

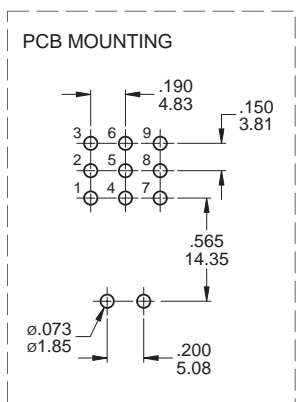
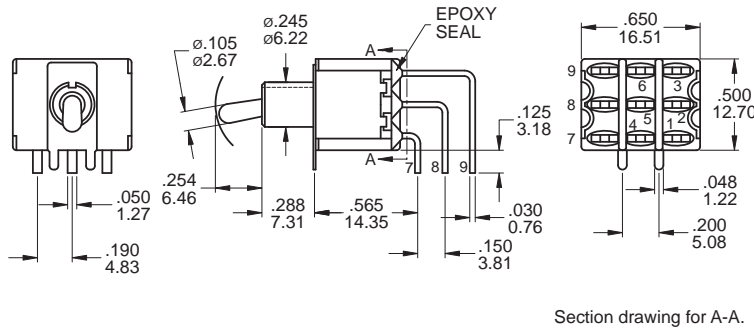

3PDT

Model name. 1M31T2B4M7QES

M7

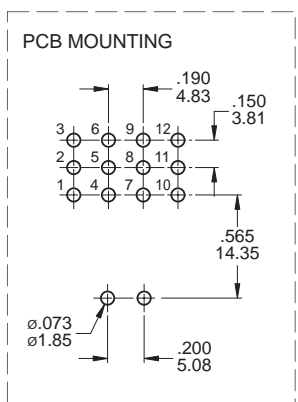
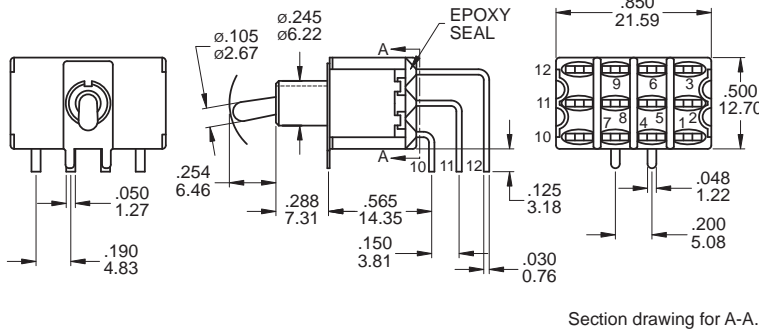

4PDT

Model name. 1M41T2B4M7QES

VS2 / VS3

(V2N - Snap-in)

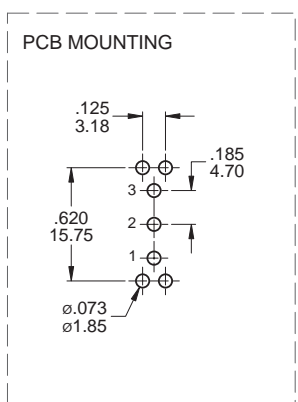
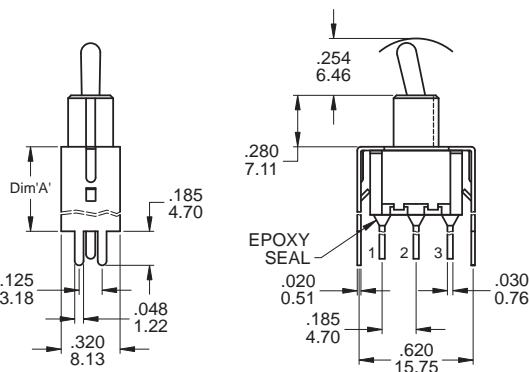

SPDT

Model name. 1MS1T2B4VS2QES

1M Series

Miniature Toggle Switches



1M Series
Toggle Switches

VS2 / VS3 (V2N - Snap-in)

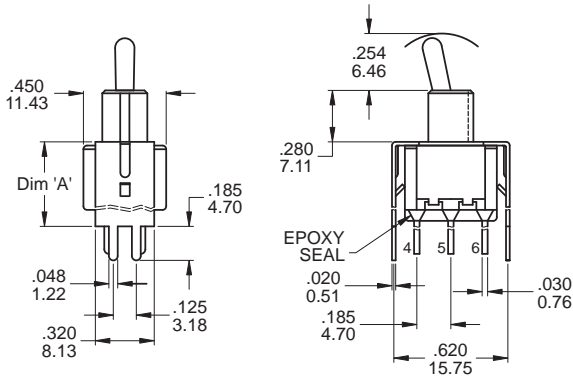

OPTION CODE	DIM. 'A'
VS2 (V2N)	.460 11.68
VS3	.630 16.00

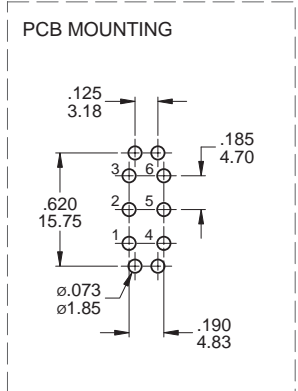

DPDT

Model name. 1MD1T2B4VS2QES

VS4 / VS5

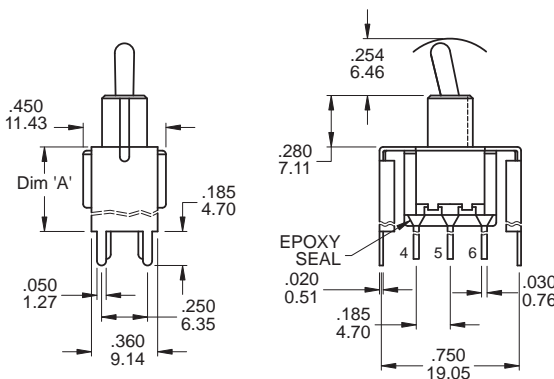

OPTION CODE	DIM. 'A'
VS4	.460 11.68
VS5	.630 16.00

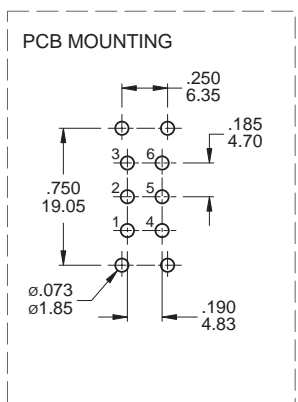

DPDT

Model name. 1MD1T2B4VS5QES

▼ SNAP-IN TERMINAL OPTIONS

M6N

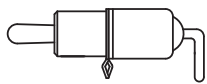
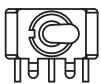

V2N

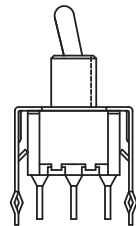

▼ HARDWARE

EXAMPLE: -
 Model name. 5 Standard hardware

* Standard for B1 bushing : 2 nut, 1 locking ring, 1 lockwasher
* For further information please consult sales representativity.

1/4 NUT (Std.)

Model name. MNU-1M01A

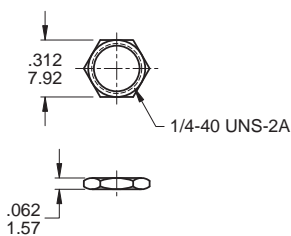

DRESS NUT

Model name. MNU-1M29
MOQ: 10K

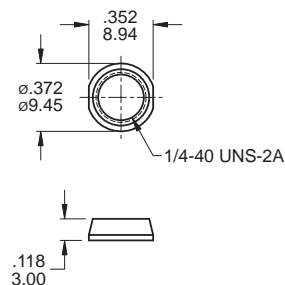

METRIC NUT (Std.)

Model name. MNU-1M04

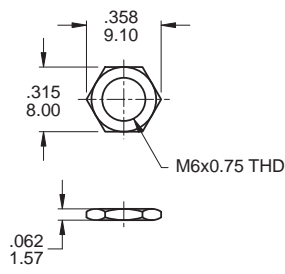

Available with bushing B8 only.

LOCKWASHER (Std.)

Model name. MNU-1M03

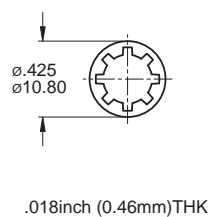

For 1/4-40 UNS-2A bushing

LOCKING RING (Std.)

Model name. MNU-1M02

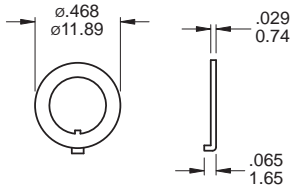

For 1/4-40 UNS-2A bushing

LOCKING RING (Std.)

Model name. MNU-1M11

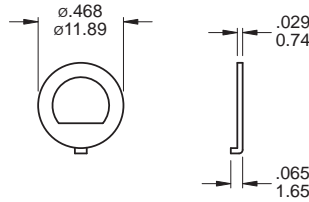

Available with bushing B5 only.

LOCKING RING (Std.)

Model name. MNU-1M08

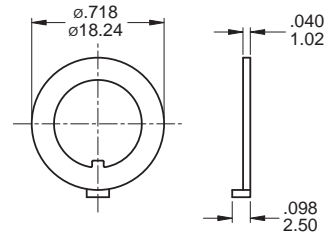

For 15/32-32 UNS-2A bushing

LOCKING RING (Std.)

Model name. MNU-1M05

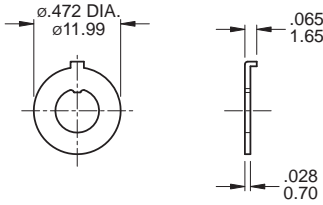

Available with bushing B8 only.

15/32 NUT (Std.)

Model name. MNU1M07

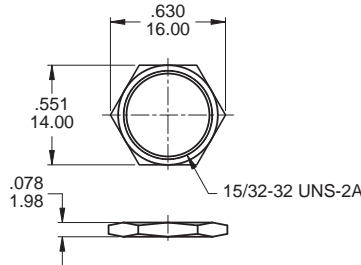

LOCKWASHER (Std.)

Model name. MNU-1M09

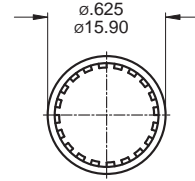

For 15/32-32 UNS-2A bushing

RUBBER HOOD SEALING

Model name.

E1-RUBBER HOOD(Inch) (Std.)

K1-RUBBER HOOD-K1(Metric) MOQ: 2K

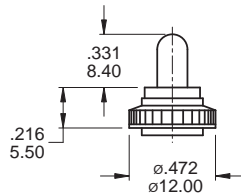

Note: For actuator T1, T2 and B1, B3, B5, B6 Bushing only

DRESS NUT

Model name. MNU-1M18

MOQ: 10K

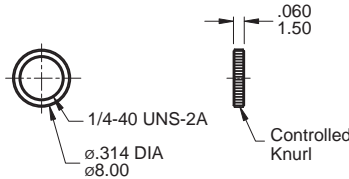

DRESS NUT

Model name. MNU-1M24

MOQ: 10K

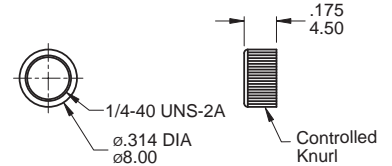

▼ CONTACT & TERMINAL PLATING OPTIONS

	CONTACT PLATING	TERMINAL PLATING	RATINGS
Q	Silver	Silver	5 Amps with resistant load @ 120VAC or 28VDC
C	Gold over Silver	Gold over silver	2 Amps with resistant load @ 250VAC
R	Gold	Gold	0.4 Volt - Amps (VA) max. @ 20V max. (AC or DC)

▼ SOLDERING PROCESS

MANUAL SOLDERING: Use 30 watts soldering iron and controlled the temperature at 350°.

Duration of solder immersion: Max. 5 sec.

WAVE SOLDERING: Recommend soldering temperature: 260 ± 5°C

Duration of solder immersion: Max. 5 sec. (PCB thickness is 1.6mm)