

# 720P high definition digital wireless system manual



ISO/TS 16949



ISO 9001:2008



Thank you very much for purchasing our company's visual safety assistance system for vehicles and mechanical equipment. To improve operational efficiency and provide security for personnel and machinery, we strictly follow the IATF 16949 quality. The management system, the product adopts the industrial grade raw material plan design, and the advanced detection equipment provides reliable, sex and stability. Products conform to China MA, Europe and the United States FCC, CE, E-MARK, Japan and other international standards.

## System characteristics

- ★ The digital wireless vehicle display adopts 7 inches 1024x600 high definition LCD screen and high temperature resistant ABS material.
- ★ The display has wide range of voltage input DC8V-32V, which is widely used for vehicle and machinery safety monitoring.
- ★ The display has built-in 2.4G wireless reception and wireless reception range up to 300 meters (open distance).
- ★ The display built-in power reverse polarity protection circuit design, effectively prevent human error operation damage equipment
- ★ The display backlight has built-in constant voltage and constant current circuit protection design, and the service life is extended.
- ★ The display OSD menu can be set up separately for each camera to flip up and down.
- ★ The display of single screen channel can set up automatic cycle switching mode.
- ★ Display multi screen display, display mode can be set arbitrarily.
- ★ The display supports four channels of wireless digital video reception, and can display single picture, two picture, three picture and four picture mode.
- ★ The reversing scale shows the safe operation of auxiliary reversing.
- ★ The complete and compact structure design of the display has 8G seismic strength.
- ★ 720P Digital HD wireless car camera shell uses aluminum alloy design, anti fog and waterproof level IP69K;

## Matters needing attention

- ★ Before using the company's products, read the instructions about functions and so on.
- ★ The red and black power cables of the display are respectively connected to the main power supply of the engine of vehicle equipment, and the voltage range is DC8-32V.
- ★ After installation, ensure all connections are secure and reliable.
- ★ The monitor is not waterproof, and the monitor should not be placed outside.
- ★ Do not arbitrarily disassemble the camera housing, so as not to damage the waterproof function.
- ★ When cleaning cameras and monitors, the main body should not be cleaned with corrosive chemical cleaners to avoid damage to the shell.

### warning

The maintenance of the system must be maintained by professionals. Please do not disassemble and improve the system at will.  
This product system is only a visual auxiliary function for vehicle mechanical equipment operation safety, and is not responsible for safety accidents.  
This manual is for reference only. If there are no details and changes, without prior notice, the final interpretation will be owned by the company.

## Schematic diagram of system installation

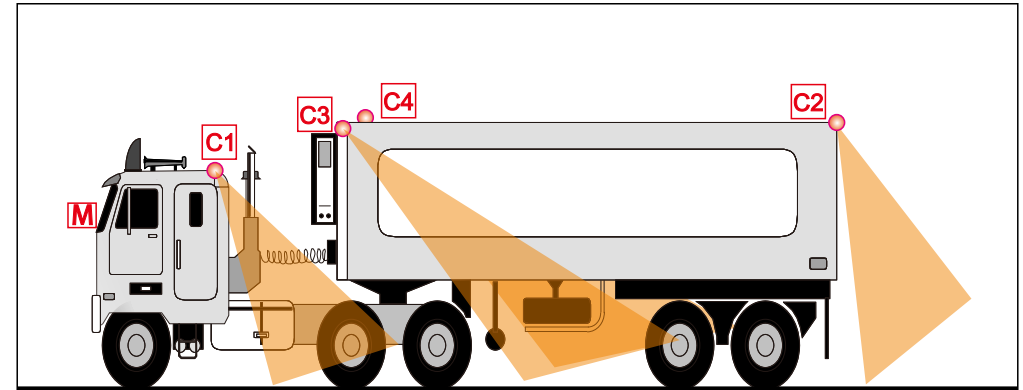

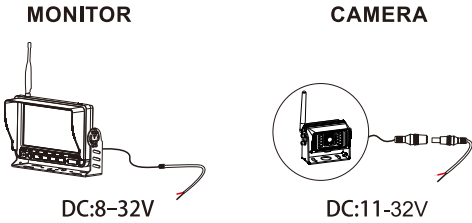
M	MONITOR	
C1	Forward camera	
C2	Rear camera	
C3	Left camera	
C4	Right camera	

## Applicable vehicles

1	Sedan				
2	Truck				
3	RV / SUV				
4	Bus / school bus				
5	Heavy truck				
6	Engineering car				
7	Agricultural machinery				
8	Forklift				

## Camera technical parameters

camera	Digital wireless infrared waterproof camera
Emissive power	18dBm
image sensor	1/3.7" colour CMOS
Valid pixel	PAL:1280(H)X960(V)
Definition	720P
IR-CUT	Automatic switching
Minimum illuminance	0 LUX ( Built in 6PCS infrared light to turn on )
viewingangle	120°
Waterproof grade	IP69K
Shockproofgrade	10G
Workingvoltage	DC 8~32V
Shapesize	118.5(W) x 76(H) x 70.5(D) mm

## System size drawing

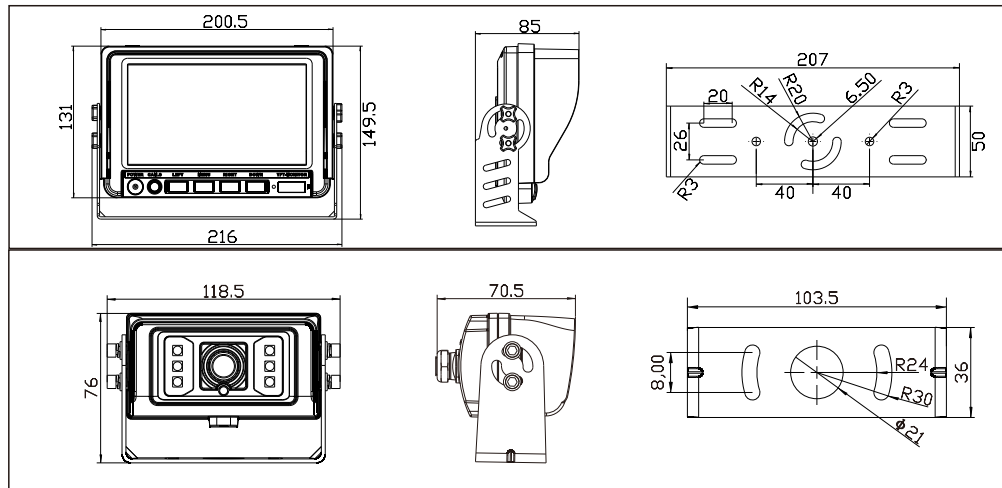

## Enclosure

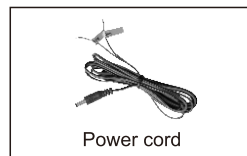

## Monitor key press instructions

1	Power	
2	OK	
3	Left key / volume -	
4	MUNE	
5	Right key / volume +	
6	Down key (channel switching)	
7	Nameplate	

## Monitor technical parameters

Display device	Color LCD monitor
LCD display size	7"
frequency range	2400 ~ 2483.5MHz
Receiving sensitivity	≤ -86dBm(1MHZ QPSK MD300RE)
Resolution	1024 × (RGB) × 600
viewing angle (LR/UD)	L/R: 85/85 U/D: 85/85
contrast ratio	500:1
LED brightness (cd/m <sup>2</sup> )	600
response time (ms)	25
Receiving range	300M ( Open distance )
Throw the load	DC 12+87V/400ms
working temperature	-20℃~+70℃
Storage temperature	-30℃~+80℃
Input power supply	DC 8~32V ( 5W Max)
Shape size (L x W x T)	216X149.5X85 (mm) (Sunshade cap with bracket)

## Monitor menu operation instructions

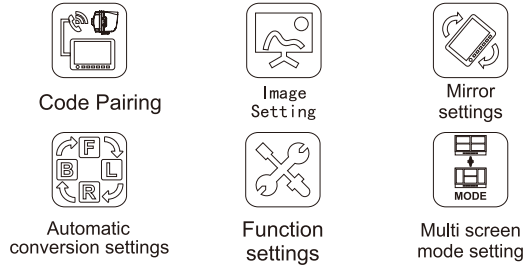

- 1) Code Pairing:  
Enter the menu ,select code pairing option, start pairing the wireless signal code and countdown 20 seconds, please press pair key on camera side or connect(or reconnect) the power of the camera within the time, wait few seconds, code paired up and image display successfully

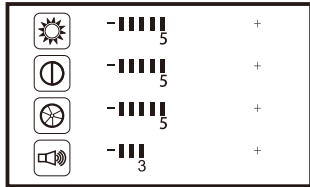

- 2) Image settings:  
Enter the menu, select the image settings options menu, press the confirmation button to enter the image settings:
- Brightness setting: 0-9 (left / right key adjustment step size)
  - Contrast settings: 0-9 (left / right key adjustment step size)
  - Color settings: 0-9 (left / right key adjustment step size)
  - Volume control: 0-9 (left / right key adjustment step size)

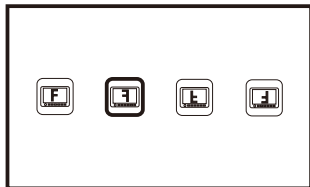

- 3) Mirror settings:  
Set the four states of the CAM1/CAM2/CAM3/CAM4 channel image:  
Positive image, mirror image, vertical flip image and vertical flip mirror,Default state: mirror.

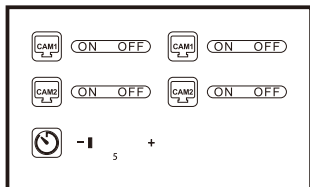

- 4) Automatic switch mode settings:
- Set up CAM1/CAM2/CAM3/CAM4 channel automatic switching mode to turn on and off;
  - Set CAM1/CAM2/CAM3/CAM4 channel automatic switching mode time value 5~45,Default state: 5S.

## Monitor menu operation instructions

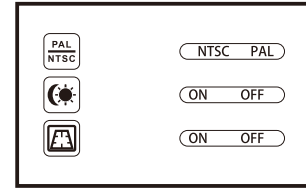

- 5) Function settings:
- Switch between NTSC and PAL, Default state:NTSC;
  - Set up the LED screen environment light source mode to turn on and off;
  - Reversing scale setting: set up CAM2 channel reversing scale open and close.

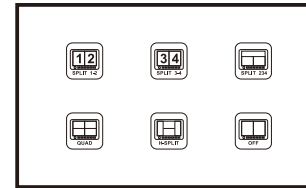

- 6) Multi screen mode display settings:
- Set the screen to be displayed when switching to multi-screen. Five modes select 1/2 two pictures, 3/4 two pictures, 2/3/4 three pictures, 1/2/3/4 four pictures, and H-type 1/2/3/4 four pictures;
  - Can be set to open and close, the default state to open, the display mode is 田 four screen.