

Datasheet

RS Pro Free Swinging or Detent Plastic Hinge with Caps

RS Stock No: 124-1907

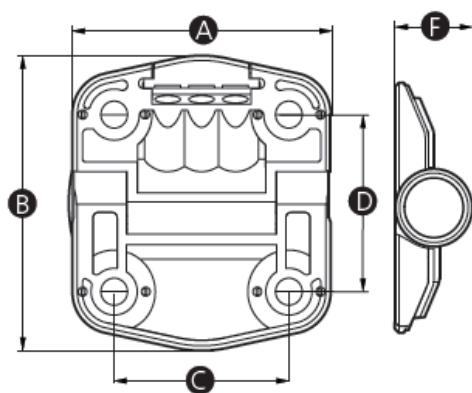

Material

High impact resistant thermoplastic

Finish

Matt

Colour

Black

Function

Select one of the available detent options to allow doors to be held open at a predetermined opening angle. Secure, snap-on caps fully conceal mounting screws.

Part No.	A	B	C	D	E	F	Hole size	Detent	Detent angle
1241906	51	57	34	34	-	18	5.2	None	-
1241907	51	57	34	34	-	18	5.2	Yes	80
1241908	51	57	34	34	-	18	5.2	Yes	115
1241909	51	57	34	34	-	18	5.2	Yes	150

Part No.	Hinge positioning torque (Nm)	Screw	Radial load (N)	Axial load (N)	Recommended tightening torque (Nm)	Approx. shear force per screw (kN)
1241906	-	M5	450	450	1.5	0.28
1241907	1.2	M5	450	450	1.5	0.28
1241908	1.2	M5	450	450	1.5	0.28
1241909	1.2	M5	450	450	1.5	0.28

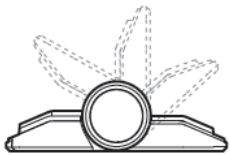

No detent / Free swinging

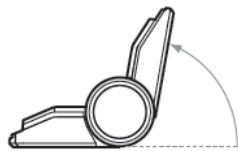

80°

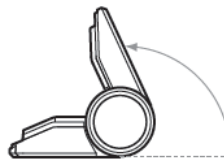

115°

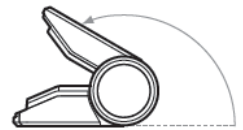

150°