

Datasheet

Two spoke handwheel with revolving handle

RS Stock No: 1611991

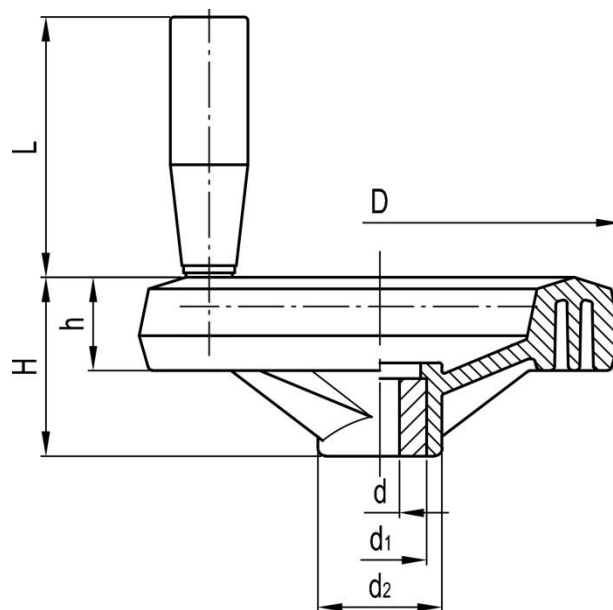

Specification

Handwheel material: Glass-fibre reinforced technopolymer

Revolving handle material: Glass-fibre reinforced technopolymer

Zinc-plated steel hub, standard holes



ENGLISH

Stock no	D	d	H	h	d1	d2	L
1611986	80	8	35	18	18	24	50
1611987	80	10	35	18	18	24	50
1611988	100	10	37	20	18	24	50
1611989	100	12	37	20	18	24	50
1611990	126	10	46	24	24	32	70
1611991	126	12	46	24	24	32	70
1611992	126	14	46	24	24	32	70
1611993	126	15	46	24	24	32	70
1611994	160	10	52	26.5	26	40	85
1611995	160	12	52	26.5	26	40	85
1611996	160	14	52	26.5	26	40	85
1611997	160	16	52	26.5	26	40	85
1611998	200	10	62	28	30	50	85
1611999	200	16	62	28	30	50	85
1612000	200	20	62	28	30	50	85