

GasAlert **MaxXT II**

1, 2, 3, 4 Gas Detector

Quick Reference Guide

BW
Technologies
by Honeywell

Limited Warranty and Limitation Liability

BW Technologies LP (BW) warrants the product to be free from defects in material and workmanship under normal use and service for a period of two years, beginning on the date of shipment to the buyer. This warranty extends only to the sale of new and unused products to the original buyer. BW's warranty obligation is limited, at BW's option, to refund of the purchase price, repair or replacement of a defective product that is returned to a BW authorized service center within the warranty period. In no event shall BW's liability hereunder exceed the purchase price actually paid by the buyer for the Product.

This warranty does not include:

- a) fuses, disposable batteries or the routine replacement of parts due to the normal wear and tear of the product arising from use;
- b) any product which in BW's opinion, has been misused, altered, neglected or damaged, by accident or abnormal conditions of operation, handling or use;
- c) any damage or defects attributable to repair of the product by any person other than an authorized dealer, or the installation of unapproved parts on the product; or

The obligations set forth in this warranty are conditional on:

- a) proper storage, installation, calibration, use, maintenance and compliance with the product manual instructions and any other applicable recommendations of BW;
- b) the buyer promptly notifying BW of any defect and, if required, promptly making the product available for correction. No goods shall be returned to BW until receipt by the buyer of shipping instructions from BW; and
- c) the right of BW to require that the buyer provide proof of purchase such as the original invoice, bill of sale or packing slip to establish that the product is within the warranty period.

THE BUYER AGREES THAT THIS WARRANTY IS THE BUYER'S SOLE AND EXCLUSIVE REMEDY AND IS IN LIEU OF ALL OTHER WARRANTIES, EXPRESS OR IMPLIED, INCLUDING BUT NOT LIMITED TO ANY IMPLIED WARRANTY OF MERCHANTABILITY OR FITNESS FOR A PARTICULAR PURPOSE. BW SHALL NOT BE LIABLE FOR ANY SPECIAL, INDIRECT, INCIDENTAL, OR BASED ON CONTRACT, TORT OR RELIANCE OR ANY OTHER THEORY.

Since some countries or states do not allow limitation of the term of an implied warranty, or exclusion or limitation of incidental or consequential damages, the limitations and exclusions of this warranty may not apply to every buyer. If any provision of this warranty is held invalid or unenforceable by a court of competent jurisdiction, such holding will not affect the validity or enforceability of any other provision.

Contacting BW Technologies by Honeywell

USA: 1-888-749-8878

Canada: 1-800-663-4164

Europe: +44(0) 1295 700300

Other countries: +1-403-248-9226

Email us at: info@gasmonitors.com

Visit BW Technologies by Honeywell's website at: www.gasmonitors.com

GasAlertMaxXT II

Introduction

The Quick Reference Guide provides basic information to operate the GasAlertMaxXT II gas detector. For complete operating instructions, refer to the *GasAlertMaxXT II Technical Reference Guide* provided on the CD-ROM. The GasAlertMaxXT II gas detector (“the detector”) is designed to warn of hazardous gas levels above user-defined alarm setpoints.

The detector is a personal safety device. It is your responsibility to respond properly to the alarm.

Note

The detector is shipped with English as the default displayed language. Additional languages provided are French, German, Spanish, and Portuguese. The screens for the additional languages are displayed on the detector and in the corresponding operator’s manual.

Zeroing the Sensors

To zero the sensors, refer to steps #1-3 in Calibration on page 9.

Safety Information - Read First

Use the detector only as specified in this operator’s manual and the technical reference guide, otherwise the protection provided by the detector may be impaired.

Read the following **Cautions** before using the detector.

Cautions

- **Warning:** Substitution of components may impair Intrinsic Safety.
- **Caution:** For safety reasons, this equipment must be operated and serviced by qualified personnel only. Read and understand the technical reference guide completely before operating or servicing.
- **Charge** the detector before first-time use. BW recommends the detector be charged after every workday.
- **Calibrate** the detector before first-time use and then on a regular schedule, depending on use and sensor exposure to poisons and contaminants. The sensors must be calibrated regularly and at least once every 180 days (6 months).

GasAlertMaxXT II

Quick Reference Guide

- Calibrate only in a safe area that is free of hazardous gas in an atmosphere of 20.9 % oxygen.
- The combustible sensor is factory calibrated to 50% LEL methane. If monitoring a different combustible gas in the % LEL range, calibrate the sensor using the appropriate gas.
- Only the combustible gas detection portion of this instrument has been assessed for performance by CSA International.
- Protect the combustible sensor from exposure to lead compounds, silicones, and chlorinated hydrocarbons. Although certain organic vapors (such as leaded gasoline and halogenated hydrocarbons) may temporarily inhibit sensor performance, in most cases the sensor will recover after calibration.
- BW recommends that the combustible sensor be checked with a known concentration of calibration gas after any exposure to contaminants/poisons such as sulfur compounds, silicon vapors, halogenated compounds, etc.
- BW recommends to bump test the sensors before each day's use to confirm their ability to respond to gas by exposing the detector to a gas concentration that exceeds the alarm setpoints. Manually verify that the audible and visual alarms are activated. Calibrate if the readings are not within the specified limits.
- Caution: High off-scale LEL readings may indicate an explosive concentration.
- Any rapid up scaling reading followed by a declining or erratic reading may indicate a gas concentration beyond upper scale limit, which can be hazardous.

- For use only in potentially explosive atmospheres where oxygen concentrations do not exceed 20.9% (v/v).
- Extended exposure of the GasAlertMax XT II to certain concentrations of combustible gases and air may stress the detector element that can seriously affect its performance. If an alarm occurs due to a high concentration of combustible gases, recalibration should be performed, or if needed, the sensor replaced.
- The BW pump (XT-RPUMP-K1) is certified for use with the GasAlertMax XT II only.
- **Warning:** The lithium battery (MX-BAT01) may present a risk of fire or chemical burn hazard if misused. Do not disassemble, heat above 212°F (100°C), or incinerate.
- **Warning:** Do not use any other lithium batteries with the GasAlertMax XT II detector. Use of any other cell can cause fire and/or explosion. To order and replace the MX-BAT01 lithium battery, contact [BW Technologies by Honeywell](#).
- **Warning:** Lithium polymer cells exposed to heat at 266°F (130°C) for 10 minutes can cause fire and/or explosion.
- Dispose of used lithium cells immediately. Do not disassemble and do not dispose of in fire. Do not mix with the solid waste stream. Spent batteries must be disposed of by a qualified recycler or hazardous materials handler.
- Keep lithium cells away from children.
- Calibrations and bump tests can be performed using a 0.5 l/min. regulator or a demand flow regulator. If the demand flow regulator is used, it must meet the following maximum inlet pressure specifications:
 - Disposable cylinders 0-3000 psig/70 bar
 - Refillable cylinders 0-3000 psig/70 bar

- Products may contain materials that are regulated for transportation under domestic and international dangerous goods regulations. Return product in compliance with appropriate dangerous goods regulations. Contact freight carrier for further instructions.

Informations sur la sécurité - À lire avant toute chose

Respectez strictement les instructions d'emploi figurant dans ce manuel d'utilisation ainsi que dans le guide technique, sinon, la protection offerte par le détecteur pourrait être diminuée.

Lisez les **Précautions** suivantes avant d'utiliser le détecteur.

⚠ Précautions

- **Avertissement:** Le remplacement d'un composant de l'appareil peut altérer sa sécurité intrinsèque.
- **Précaution:** Pour des raisons de sécurité, cet appareil doit être exclusivement utilisé et entretenu par du personnel qualifié. Lisez attentivement le guide technique avant
- d'utiliser l'appareil ou d'en assurer l'entretien, et assurez-vous d'en avoir bien compris les instructions.
- Chargez le détecteur avant sa première utilisation. BW recommande de recharger le détecteur après chaque journée d'utilisation.
- Étalonnez le détecteur avant sa première utilisation, puis de manière régulière, en fonction de l'utilisation et de l'exposition du capteur aux poisons et autres contaminants. Les capteurs doivent être étalonnés régulièrement et au moins une fois tous les 180 jours (6 mois).
- Veillez à effectuer l'étalonnage dans une zone sûre, exempte

de gaz dangereux, dans une atmosphère contenant 20,9 % d'oxygène.

- Le capteur de gaz combustible est étalonné en usine au méthane à une concentration de 50% LIE. Si la surveillance porte sur un autre gaz combustible dans la plage de %LIE, étalonnez le capteur en utilisant le gaz approprié.
- Sur cet appareil, seule la détection de gaz combustible a fait l'objet d'une évaluation des performances par CSA International.
- Protégez le capteur de gaz combustible des expositions aux composés de plomb, aux silicones et aux hydrocarbures chlorés. Bien que certaines vapeurs organiques (comme l'essence au plomb ou les hydrocarbures halogénés) puissent neutraliser provisoirement les performances du capteur, dans la plupart des cas, le capteur retrouvera son fonctionnement normal après étalonnage.
- Si le capteur de gaz combustible a été exposé à des contaminants/poisons (composés de soufre, vapeurs de silicium, produits halogénés, etc.), il est conseillé de vérifier son bon fonctionnement en le mettant en présence d'une concentration connue d'un gaz.
- BW recommande d'effectuer un " test fonctionnel " des capteurs, avant chaque utilisation quotidienne, afin de vérifier qu'ils réagissent bien au gaz, notamment lorsque le détecteur est exposé à une concentration de gaz qui dépasse les seuils d'alarme. Vérifiez manuellement que les alarmes sonore et visuelle sont activées. Étalonnez l'appareil si les lectures sont en dehors des limites spécifiées.
- **Précaution:** Des lectures élevées hors échelle peuvent indiquer la présence d'une concentration explosive.

GasAlertMaxXT II

Quick Reference Guide

- Une lecture qui augmente rapidement, puis qui baisse, ou une lecture fantaisiste peuvent être représentatives d'une concentration de gaz excédant la limite d'échelle supérieure et risquant donc d'être dangereuse.
- Cet appareil est uniquement destiné aux atmosphères potentiellement explosives où la concentration d'oxygène ne dépasse pas 20,9 % (v/v).
- L'exposition prolongée du GasAlertMax XT II à certaines concentrations de gaz combustible et d'air peut fortement éprouver l'élément du détecteur et nuire gravement à ses performances. En cas d'alarme, suite à une forte concentration de gaz combustible, il convient d'effectuer un réétalonnage, voire de remplacer le capteur si nécessaire.
- La pompe BW (XT-RPUMP-K1) est certifiée pour une utilisation avec le GasAlertMax XT II uniquement.
- **Avertissement:** La batterie au lithium (MX-BAT01) peut présenter un risque d'incendie ou de brûlure chimique en cas de mauvaise utilisation. Elle ne doit jamais être démontée, incinérée ni chauffée au-delà de 100 °C.
- **Avertissement:** N'utilisez jamais d'autres piles au lithium avec le détecteur GasAlertMax XT II, au risque de provoquer un incendie et/ou une explosion. Pour commander une batterie au lithium MX-BAT01 de rechange, contactez BW Technologies by Honeywell.
- **Avertissement:** Les piles au lithium polymère exposées à une température supérieure à 130 °C pendant plus de 10 minutes peuvent provoquer un incendie et/ou une explosion.
- Mettez immédiatement au rebut les piles au lithium usagées. Ne les démontez jamais et ne les jetez pas au feu. Ne les

mélangez pas aux autres déchets solides. Les piles usagées doivent être éliminées par un centre de recyclage agréé ou un centre de traitement des matières dangereuses.

- Gardez les piles au lithium hors de portée des enfants.
- **Avertissement:** BW Technologies recommande l'utilisation de gaz d'étalonnage de haute qualité et de bouteilles répondant aux normes nationales. Les gaz d'étalonnage doivent correspondre à la précision du détecteur.
- Les tests fonctionnels et les étalonnages peuvent être effectués en utilisant un régulateur 0,5 l/min. ou un régulateur de débit à la demande. Si vous utilisez le régulateur de débit à la demande, ce dernier doit répondre aux spécifications de pression d'entrée maximale suivantes :
 - Bouteilles jetables 0-3 000 psig/70 bar
 - Bouteilles rechargeables 0-3 000 psig/70 bar
- Les produits peuvent contenir des matériaux qui sont réglementés pour le transport en vertu des règlements nationaux et internationaux de marchandises dangereuses. Retourner le produit conformément à la réglementation sur les marchandises dangereuses appropriées. Contactez transporteur pour plus d'instructions.

Parts of the GasAlertMaxXT II

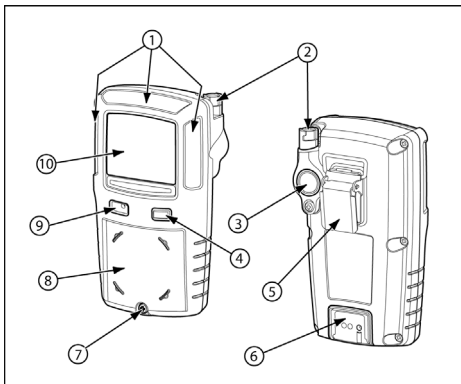

Item	Description
1	Visual alarm indicators (LEDs)
2	Pump quick connector
3	Pump filter and moisture filter
4	Pushbutton
5	Alligator clip
6	Charging connector and IR interface
7	Diffusion cover locking screw (1)
8	Diffusion cover
9	Audible alarm
10	Liquid crystal display (LCD)

Display Elements

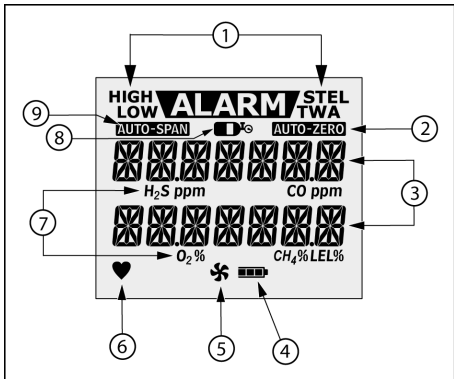

Item	Description
1	Alarm condition
2	Automatically zero sensor
3	Numeric values
4	Battery life indicator
5	Pump indicator
6	Heartbeat indicator
7	Gas type identifiers
8	Gas cylinder
9	Automatically span sensor

Pushbutton

Pushbutton	Description
	<ul style="list-style-type: none">• To activate the detector, press ○.• To deactivate the detector, press and hold ○ until the OFF countdown is complete.• To view the date/time, TWA, STEL, and maximum (MAX) readings, press ○ twice rapidly. To clear the TWA, STEL, and MAX readings, press ○ when the LCD displays CLEAR ALL.• To initiate calibration, press and hold ○ while the detector performs the OFF countdown. Continue holding ○ while the LCD briefly deactivates and then reactivates to begin the CAL countdown. Release ○ when the CAL countdown is complete.• To activate the backlight, press ○ and release.• To acknowledge latched and pump alarms, press ○.• To acknowledge a low alarm and disable the audible alarm, press ○. The Low Alarm Acknowledge option must be enabled in Fleet Manager II.• To acknowledge any of the Due Today alarms (calibration, bump test, block test) and disable the audible alarm, press ○.

Calibration and Bump Test Installation

Gas Cylinder Guidelines

- To ensure accurate calibration, use a premium-grade calibration gas. Use gases approved by the National Institute of Standards and Technology.
- If a certified calibration is required, contact BW Technologies by Honeywell.
- Do not use a gas cylinder that is past its expiration date.

Gas Cylinder Connection

1. Verify the calibration gas being used matches the span concentration value(s) that are set for the detector.
2. Connect the calibration hose to a 0.5 l/min regulator or demand flow regulator on the gas cylinder.
3. Begin the calibration procedures.
4. When **AUTO-SPAN** displays, attach the hose quick connector to the pump quick connector.
5. When calibration is complete, turn off the gas, and disconnect the hose from the detector and the demand flow regulator.
6. Ensure the gas cylinder is stored according to manufacturer's specifications.

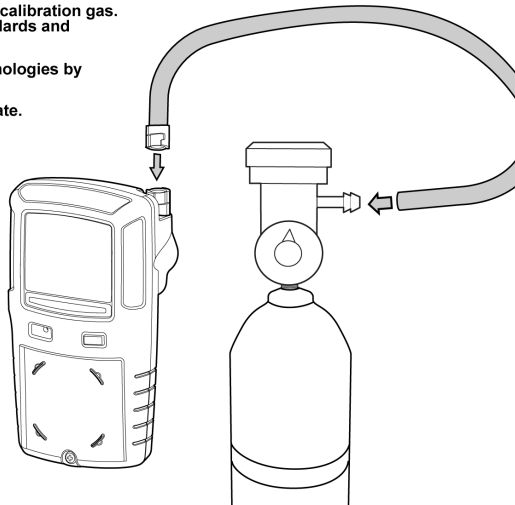



Calibration

⚠ Caution

Calibrate only in a safe area that is free of hazardous gas in an atmosphere of 20.9 % oxygen. Do not calibrate the detector during or immediately after charging is complete.

Note

The maximum hose length for calibration is 3 ft. (1 m).

1. Press and hold  as the detector performs the **OFF** countdown. Continue to hold  when the detector briefly deactivates.



2. The detector activates again and performs the **CAL** countdown. Continue to hold  until the countdown is complete to enter calibration.



3. **AUTO-ZERO** flashes while the detector zeroes all of the sensors.

If a sensor fails to auto zero, it cannot be spanned. When auto zero is complete, the LCD displays **APPLY GAS**.

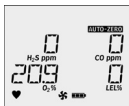

4. Refer to [Calibration and Bump Test Installation](#) (page 6). Attach the 0.5 l/min. regulator or the demand flow regulator and apply gas.

Note

The diffusion cover must be attached to the detector to calibrate.

 flashes on the LCD. After a sufficient amount of gas has been detected (30 seconds), the detector beeps.

AUTO-SPAN flashes while the detector completes the span.

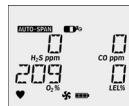

5. The LCD displays **CAL DUE**. Next, a screen displays showing the number of days remaining before calibration is due for each sensor. Last, the LCD displays (e.g.) **CAL DUE 180 d**. As some sensors require more frequent calibrations, the LCD displays the earliest calibration that must be performed.



Note

Calibration can be aborted at any time. To abort calibration, press . The **CAL ABORTED** screen displays.



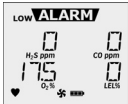
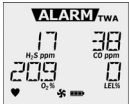
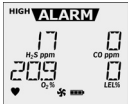
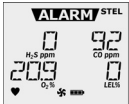
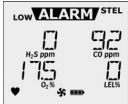
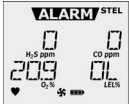

Alarms

Refer to the following table for information about alarms and corresponding screens.

Alarm	Screen	Alarm	Screen
Low Alarm <ul style="list-style-type: none"> • Slow siren • Slow alternating flash • ALARM and target gas bar flash • Vibrator alarm activates 		TWA Alarm <ul style="list-style-type: none"> • Fast siren • Fast alternating flash • ALARM and target gas bar flash • Vibrator alarm activates 	
High Alarm <ul style="list-style-type: none"> • Fast siren • Fast alternating flash • ALARM and target gas bar flash • Vibrator alarm activates 		STEL Alarm <ul style="list-style-type: none"> • Fast siren • Fast alternating flash • ALARM and target gas bar flash • Vibrator alarm activates 	
Multi-Gas Alarm <ul style="list-style-type: none"> • Alternating low and high alarm siren and flash • ALARM and target gas bars flash • Vibrator alarm activates 		Over Limit (OL) Alarm <ul style="list-style-type: none"> • Fast siren • Fast alternating flash • ALARM and target gas bar flash • Vibrator alarm activates 	

Note

If the **Low Alarm Acknowledge** option is enabled in Fleet Manager II, the low alarm can be acknowledged and the audible alarm deactivated by pressing . If the alarm escalates to a high, STEL, TWA, or multi-gas alarm, the audible alarm reactivates.

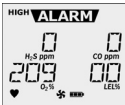
Alarm	Screen	Alarm	Screen
<p>Sensor Alarm</p> <ul style="list-style-type: none"> ERR displays 		<p>Automatic Deactivation Alarm</p> <ul style="list-style-type: none"> Sequence of 10 rapid sirens and alternating flashes with 1 second of silence in between (reactivates seven times) ALARM flashes and the vibrator alarm activates TURNING OFF displays before the detector deactivates 	
<p>Low Battery Alarm</p> <ul style="list-style-type: none"> Sequence of 10 rapid sirens and alternating flashes with 7 seconds of silence in between (continues for 10 minutes)  and ALARM flashes LOW BATTERY displays and the vibrator alarm activates After 10 minutes, a sequence of 10 rapid sirens and alternating flashes with 1 second of silence in between (reactivates seven times) TURNING OFF displays before the detector deactivates 		<p>Pump Alarm</p> <ul style="list-style-type: none"> Two beeps and two flashes  and ALARM flashes HIGH displays The vibrator alarm activates 	

Note:

If enabled, during an alarm condition the Latched Alarms option causes the low and high gas alarms (audible, visual, and vibrator) to persist until the alarm is acknowledged (by pressing ) and the gas concentration is below the alarm setpoint. The LCD continues to display the high peak concentration until the alarm condition no longer exists. Enable/disable Latching Alarms in Fleet Manager II. Local regulations may require the Latching Alarms option be enabled.

Options Menu

The detector, IR Link adapter, and Fleet Manager II software are required to define options. Refer to the *GasAlertMax XT II Technical Reference Guide* and *Fleet Manager II Operator's Manual*. For user and sensor options, refer to the following:

Device Configuration

- **Startup Message Top Line:** Enter a line of text to display on the LCD during startup (maximum 25 characters).
- **Startup Message Bottom Line:** Enter a line of text to display on the LCD during startup (maximum 25 characters).
- **Lockout on Self-Test Error** (sensor alarm lock): If a sensor fails during startup and the **Lockout on Self-Test** option is enabled, **Safety Lock On** displays on the LCD and the detector deactivates.
- **Safe Mode:** If enabled, **SAFE** displays continuously on the LCD unless an alarm condition occurs.
- **Confidence Beep:** If enabled, the confidence beep provides continuous confirmation that the detector is operating correctly. To define how often the detector beeps (every **1-120** seconds), enter the value in the **Confidence Interval** field. Confidence beep is automatically disabled during a low battery alarm.
- **Latching Alarms:** Enable to ensure an alarm persists until the alarm is acknowledged and the gas concentrations are below the alarm setpoint. The audible alarm can be temporarily deactivated for 30 seconds by pressing , but the LCD continues to display the high peak concentration until the alarm condition no longer exists.
- **Force Calibration:** If enabled, the detector must be calibrated if a sensor is overdue upon startup. User defined (**0-365** days) in the **Calibration Interval** field.
- **Cal IR Lock** (must use IR device to calibrate): If enabled, the detector automatically auto zeros, but the sensors must be

spanned using the IR Link or MicroDock II station with Fleet Manager II.

- **Force Bump:** If enabled, a bump test must be performed to ensure the sensor(s) are responding correctly to the test gas. User defined (**0-365** days) in the **Bump Interval** field.
- **Location Logging:** If enabled, a series of numbers (**1-999**) can be entered on the detector to identify gas wells, plants, and other areas that identify the location where the detector is being used.
- **Force Block Test:** If enabled, a pump block test must be performed during the startup tests.
- **Datalog Interval (seconds):** Define how often the detector records a sample (every **1-120** seconds).
- **Confidence Interval (seconds):** Define how often the detector beeps (**1-120** seconds) when the **Confidence Beep** option is enabled.
- **Language:** The LCD displays the screens in **English**, **Français** (French), **Deutsch** (German), **Español** (Spanish), or **Português** (Portuguese). Select the language from the drop-down menu in Fleet Manager II.

Sensor Configuration (H₂S, CO, LEL, and O₂)

- **Sensor Disabled:** Enables/disables the selected sensor.
- **Calibration Gas (ppm):** Define the span gas concentration for each sensor. The span gas concentration must match the span value on the gas cylinder.
- **Calibration Interval (days):** Define the number of days (**0-365**) when the next calibration is due.
- **Bump Interval (days):** Define the number of days (**0-365**) when the next bump test is due.
- **Low Alarm (ppm):** Define the low alarm setpoint for each sensor.
- **High Alarm (ppm):** Define the high alarm setpoint for each sensor.

- **TWA Alarm (ppm):** Define the time-weighted average (TWA) alarm setpoint (toxic sensors only).
- **STEL Alarm (ppm):** Define the short-term exposure limit (STEL) alarm setpoint (toxic sensors only).
- **STEL Interval (minutes):** Define the short-term exposure limit (STEL) from **5-15** minutes (toxic sensors only).
- **TWA Period (hours) (TWA moving average (hours):** The TWA Period option is used to define a time-weighted moving average of accumulated gases over a period of **4-16** hours, to ensure the worker leaves the area when the defined maximum average is accumulated.
- **Correction Factor (%):** Enter the compensation factors for hydrocarbons other than methane. The factor can only be applied if the LEL sensor has been calibrated with methane (LEL only).
- **50% LEL = (%CH₄):** Enter a percentage value to display the LEL reading as %vol., assuming a methane environment (LEL only).
- **Auto-Zero on Startup:** Enable/disable the detector to automatically zero the sensor(s) during startup (H₂S, CO, LEL, and O₂).
- **LEL by Volume CH₄:** If enabled, the detector operates assuming a methane (CH₄) calibration. Enable to read and display %CH₄ values. Disable to read and display %LEL values.
- **5% LEL Over-span:** If enabled, the detector automatically over-spans the LEL sensor by 5% LEL above the span gas concentrations to ensure the detector is in compliance with CAN/CSA C22.2 No. 152.
- **20.8% Base Reading:** When enabled, the detector is configured to detect 20.8% O₂ as ambient air. When disabled, the detector is configured to detect 20.9% O₂ as ambient air.
- **Low Alarm Acknowledge:** If enabled, the audible alarm can be temporarily disabled during a low alarm

by pressing . The vibrator, alarm LEDs, and LCD remain operational (toxic and LEL only).

Maintenance

To maintain the detector in good operating condition, perform the following basic maintenance as required.

- Calibrate, bump test, and inspect the detector on a regular schedule.
- Maintain an operations log of all maintenance, bump tests, calibrations, and alarm events.
- Clean the exterior with a soft damp cloth. Do not use solvents, soaps, or polishes.
- Do not immerse the detector in liquids.

Charging the Detector

Warning

Charge only in a safe area that is free of hazardous gas within temperatures of 32°F-113°F (0°C-45°C).

Charge the battery after each workday. To charge the battery, refer to the following procedures and illustration:

1. Deactivate the detector.
2. Insert the charging adapter plug into an AC outlet.
3. Connect the charging adapter to the detector IR receptacle. Refer to the following illustration.
4. Allow the battery to charge for 6 hours.

5. To reach full battery capacity, allow a new battery to fully charge and discharge three times.

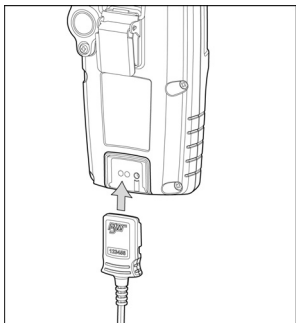

Replacing a Sensor or Sensor Filter

⚠ Warning

To avoid personal injury and/or property damage, only use sensors that are specifically designed for the detector.

Note

Detectors that are configured for 1, 2, or 3 gases may contain a dummy sensor in one of the four sensor locations.

To replace a sensor or sensor filter, refer to the following figure, table and procedures #1-13.

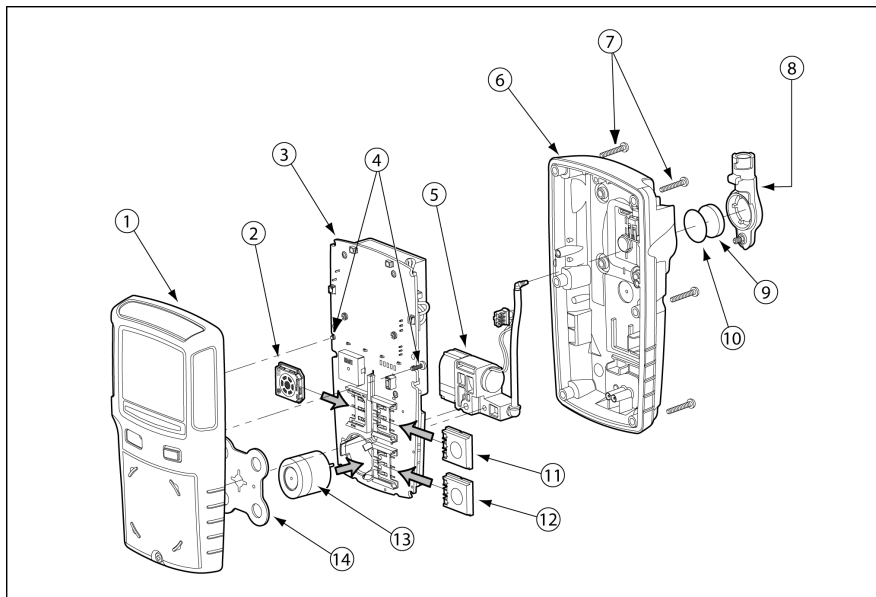

GasAlertMaxXT II

Quick Reference Guide

Item	Description
1	Front shell
2	LEL sensor
3	PCB
4	PCB screws (2)
5	Pump
6	Rear shell
7	Machine screws (6)
8	Pump inlet
9	Pump filter (particulate)
10	Moisture filter
11	CO sensor
12	H ₂ S sensor
13	O ₂ sensor
14	Sensor filter

1. Deactivate the detector.
2. Remove the pump inlet screw and the pump inlet.
3. Remove the six machine screws from the rear shell.

4. Because the pump hose is connected to the rear shell and front shell pump, carefully remove the rear shell by lifting upward and tilting to the left. Both the rear and front shell are laying flat side by side.

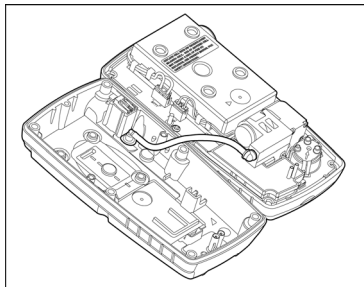

5. Remove the two PCB screws.
6. Lift the PCB upward and tilt to the left. Lay the PCB (sensors facing up) onto the rear shell.

- Slide the LEL, CO, and H₂S sensor(s) outward to remove.

To remove the oxygen sensor, gently insert a screwdriver to the back of the oxygen sensor to push out the sensor.

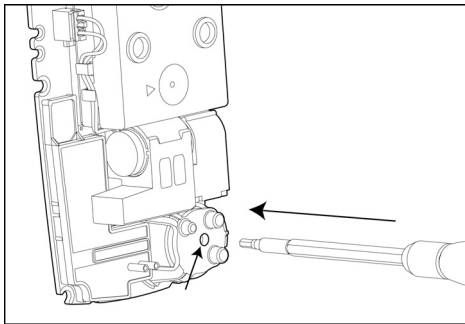

- Insert the new sensor(s) and replace the sensor filter.
- Reassemble the detector and replace the two PCB screws.
- Replace the six machine screws.
- If required, replace the pump and moisture filter.
- Replace the pump inlet and the pump inlet screw.

- Activate the detector and then calibrate the new sensor(s). Refer to [Calibration](#).

Specifications

Instrument dimensions: 13.1 x 7.0 x 5.2 cm
(5.1 x 2.8 x 2.0 in.)

Weight: 328 g (11.6 oz.)

Operating temperature: -20°C¹ to +50°C (-4°F to +122°F)

Storage temperature: -40°C¹ to +60°C (-40°F to +140°F)

Operating humidity: 10% to 100% relative humidity
(non-condensing)

Dust and moisture ingress: IP66/IP67

Alarm setpoints: May vary by region and are user-defined

Detection range:

H₂S: 0 - 200 ppm (1 ppm increments)

CO: 0 - 1000 ppm (1 ppm increments)

O₂: 0 - 30.0% vol. (0.1% vol. increments)

Combustible (LEL): 0 - 100% (1% LEL increments) or
0-4.4% v./v CH₄

- Standard release data. This product has extended characteristics. For specifications refer to EAC Ex certificate and Pattern Approval document.

GasAlertMaxXT II

Quick Reference Guide

Sensor type:

H₂S, CO, O₂: Single plug-in electrochemical cell

Combustibles: Plug-in catalytic bead

O₂ measuring principle: Capillary controlled concentration sensor

Alarm conditions: TWA alarm, STEL alarm, low alarm, high alarm, multi-gas alarm, over limit (OL) alarm, low battery alarm, confidence beep, automatic deactivation alarm, and pump alarm

Audible alarm: 95 dB+ at 30 cm variable pulsed beeper with full battery charge

Visual alarm: Red light-emitting diodes (LEDs)

Display: Alphanumeric liquid crystal display (LCD)

Backlight: Activates upon startup and when the pushbutton is pressed; deactivates after 10 seconds. Also activates during an alarm condition and remains lit until alarm ceases

Self-test: Initiated at activation and tests continuously

Calibration: Automatic zero and automatic span

User field options: Startup message, lockout on self-test error, safe mode, confidence beep, latching alarms, force calibration, cal IR lock, force bump, location logging, force block test, set datalog interval, set confidence interval, language selection

Sensor options: Sensor enable/disable, set span calibration values, set calibration interval, set bump interval, set alarm setpoints, set STEL interval, set TWA period, auto zero at

startup enable/disable, 5% over span, low alarm acknowledge, oxygen measurement, and combustible gas measurement

Battery operating time:

One rechargeable lithium polymer: 13 hours (typical)

Year of manufacture: The detector's year of manufacture is determined from the serial number. The second and third number after the second letter determines the year of manufacture. E.g., MA 110-000001 = 2010 year of manufacture

Approved batteries:

North America

Approved batteries for GasAlertMax XT II product:

Lithium-ion polymer battery as per standards EN50020, UL913, C22.2 No. 157

Rechargeable battery (MX-BAT01)	Temperature code
Lithium polymer	-20°C ≤ Ta ≤ +50°C T4

Battery charger: charging adapter

First-time charge: 6 hours

Normal charge: 6 hours

Warranty: 2 years including sensors

Approvals:

Approved by CSA to both U.S. and Canadian Standards CAN/CSA C22.2 No. 157 and C22.2 152

ANS/UL - 913 and ANSI/ISA - S12.13 Part 1

CSA	Class I, Division 1, Group A, B, C, and D
ATEX	CE 0539 (Ex) II 1 G Ex da ia IIC T4 Ga KEMA 08 ATEX 0001 EN 60079-0, EN 60079-1, EN 60079-11 Ex da ia IIC T4 Ga CSA 07.0012
IECEX	IEC 60079-0, IEC 60079-1, IEC 60079-11 Ex ia IIC T4 Ga DNV 12.0135
INMETRO	
KTL	12-KB4BO-0054 ^a
IP	IP66/IP67

a. http://www.honeywellanalytics.com/~media/honeywell-analytics/products/gasalertmax-xt-ii/documents/certifications/koreanexcertificate_bw_gamaxxtii_12kb4-bo0054.pdf?la=en

try to correct the interference by one or more of the following measures:

- Reorient or relocate the receiving antenna.
- Increase the separation between the equipment and receiver.
- Connect the equipment into an outlet on a circuit different from that to which the receiver is connected.
- Consult the dealer or an experienced radio/TV technician for help.

This equipment has been tested and found to comply with the limits for a Class B digital device, pursuant to Part 15 of the FCC Rules and ICES-003 Canadian EMI requirements. These limits are designed to provide reasonable protection against harmful interference in a residential installation. This equipment generates, uses and can radiate radio frequency energy and, if not installed and used in accordance with the instructions, may cause harmful interference to radio communications. However, there is no guarantee that interference will not occur in a particular installation. If this equipment does cause harmful interference to radio or television reception, which can be determined by turning the equipment off and on, the user is encouraged to

Wear yellow. Work safe.

129535-L3_EN_C1

[English]

© BW Technologies 2016. All rights reserved.