

Datasheet

LED Indicator 16mm White 12Vac/dc

RS Stock Number: 909-2459



Representative of range

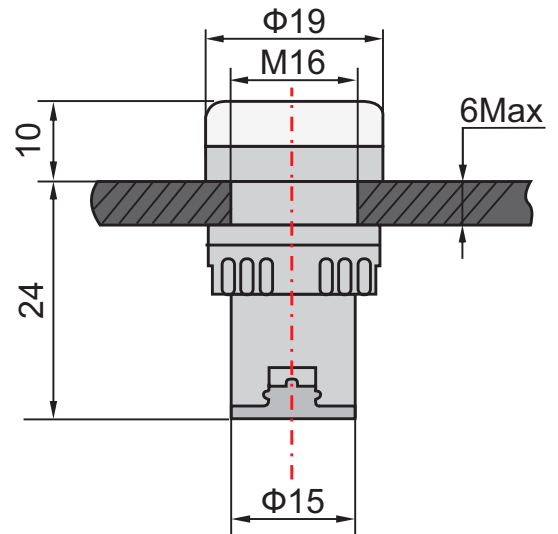

Technical Specification

Colour	White
Nominal Voltage (V_n)	12V ac/dc
Operating Voltage Range	$V_n \pm 15\%$
Frequency (ac)	50 - 60Hz
Insulation Resistance	$\geq 2M\Omega$
Insulation Withstand	2.5kVac, 1 minute
Current Draw	$\leq 20mA$
IP Rating (from front, panel mounted)	IP40
Brightness	$\geq 60 \text{ cd/m}^3$
Operational Life	30,000 hours
Relative Humidity	$\leq 98\%$
Operating Temperature Range	-25°C to +55°C