

## 717 30G & 717 100G Pressure Calibrators

### *Instruction Sheet*

#### ***Introduction***

The Fluke 717 30G and 717 100G Pressure Calibrator (hereafter, "the Calibrator") is a compact, battery-powered, 5-digit instrument that performs the following calibration and measurement functions:

- ◆ Calibrates P/I (pressure to current) transmitters.
- ◆ Measures pressure using a 1/8-inch NPT pressure fitting and an internal pressure sensor.
- ◆ Measures pressure via a Fluke 700 Series Pressure Module.
- ◆ Measures current up to 24 mA.
- ◆ Sources loop voltage (to 24 V dc).
- ◆ Displays simultaneously pressure and current measurements.

Full scale pressure sensor input for the 717 30G is 30 psi (206.84 kPa, 2.0684 bar). **OL** (overload) is displayed at 33 psi.

Full scale pressure sensor input for the 717 100G is 100 psi (689.5 kPa, 6.895 bar). **OL** (overload) is displayed at 120 psi.

The Calibrator is an IEC 61010, CAT I 30 V, Pollution Degree 2 instrument. A CAT I instrument is designed to protect against transients from high-voltage, low-energy sources like, for example, electronic circuits or a copy machine.

The Calibrator comes with a holster, an installed 9 V battery, a set of test leads and alligator clips, and a 14-language instruction sheet pack. If the Calibrator is damaged or something is missing, contact the place of purchase immediately.

## Input Units, Ranges & Resolutions









The Calibrator measures and displays pressure sensor inputs in the units, ranges, and resolutions below:

Units	717 30G	717 100G
psi	-12.000 to 30.000	-12.00 to 100.00
inH <sub>2</sub> O at 4 °C	-332.16 to 830.40	-333.2 to 2768.0
inH <sub>2</sub> O at 20 °C	-332.75 to 831.87	-332.8 to 2772.9
cmH <sub>2</sub> O at 4 °C	-843.6 to 2109.0	-843.6 to 7030.0
cmH <sub>2</sub> O at 20 °C	-845.2 to 2113.0	-845.2 to 7043.0
bar	-0.8274 to 2.0685	-0.8274 to 6.8950
mbar	-827.4 to 2068.5	-827.4 to 6895.0
kPa	-82.74 to 206.85	-82.74 to 689.50
inHg	-24.432 to 61.080	-24.43 to 203.60
mmHg	-620.6 to 1551.4	-620.6 to 5171.5
kg/cm <sup>2</sup>	-0.8437 to 2.1090	-0.8437 to 7.0306

If inappropriate units are selected, the output of Fluke 700P pressure modules can be too low to be displayed or can cause the Calibrator to display **OL** (overload). Refer to the table below for pressure unit and range compatibility.

Units	Range	Units	Range
psi	All	kPa	All
inH <sub>2</sub> O	Through 3000 psi	inHg	All
cmH <sub>2</sub> O	Through 1000 psi	mmHg	Through 3000 psi
bar	15 psi and above	kg/cm <sup>2</sup>	15 psi and above
mbar	Through 1000 psi		

## Symbols

Symbol	Meaning
	ON / OFF button
	Earth ground
	Caution: Important information. See instruction sheet
	Double insulated
	Battery
	Canadian Standards Association
	Conforms to European Union requirements
	Direct current

## Safety

A "**⚠ Warning**" identifies conditions or actions that pose hazards to the user.

A "**⚠ Caution**" identifies conditions and hazards that may damage the Calibrator or equipment under test.

### **⚠ Warnings**

**To avoid electric shock, injury, or damage to the Calibrator:**

- **Use the Calibrator only as described in this Instruction Sheet.**
- **Using the Calibrator in a manner not specified by the manufacturer might impair the protection provided by the Calibrator.**
- **Do not use the Calibrator around explosive gas, vapor, or dust.**
- **Inspect the Calibrator before use. Do not use it if appears damaged.**
- **Check the test leads for continuity, damaged insulation, or exposed metal. Replace damaged test leads.**
- **Never apply more than 30 V between any two terminals, or between any terminal and earth ground.**
- **Use the proper terminals, mode, and range for your measuring or sourcing application.**
- **To prevent damage to the unit under test, put the Calibrator in the correct mode before connecting the test leads.**
- **When making connections, connect the COM test lead before the live lead; when disconnecting, disconnect the live lead before the COM lead.**
- **Never use the Calibrator with the case open.**
- **Make sure the battery door is closed before you use the Calibrator.**
- **Replace the battery as soon as the  (low battery) symbol appears to avoid false readings that can lead to electric shock.**
- **Remove test leads from the Calibrator before opening the case or battery door.**
- **To avoid a violent release of pressure in a pressurized system, shut off the valve and slowly bleed off the pressure before you attach or detach the pressure sensor or Pressure Module fitting to the pressure line.**
- **When servicing the Calibrator, use only specified replacement parts.**

**⚠ Caution**

**When using pressure**, to avoid damage to the Calibrator module connections, follow all procedures in the pressure module instruction sheet.

**⚠ Caution**

**When using pressure sensor connections**, to avoid damage to the Calibrator or equipment to which it is attached:

- For the Model 717 30G, to avoid overpressure damage, do not apply pressure that exceeds 3 times top of range (90 psi, 620 kPa, 6.2 bar).
- For the Model 717 100G, to avoid overpressure damage, do not apply pressure that exceeds 2 times top of range (200 psi, 1378 kPa, 13.78 bar).
- To avoid corrosion in the pressure sensor, use the Calibrator only with media compatible with glass, ceramic, silicon, RTV, nitrile (Buna -N) type 303 stainless steel, and nickel.
- To avoid damaging the Calibrator, do not apply torque between the pressure fitting and the Calibrator case. See the figure below for the proper technique.

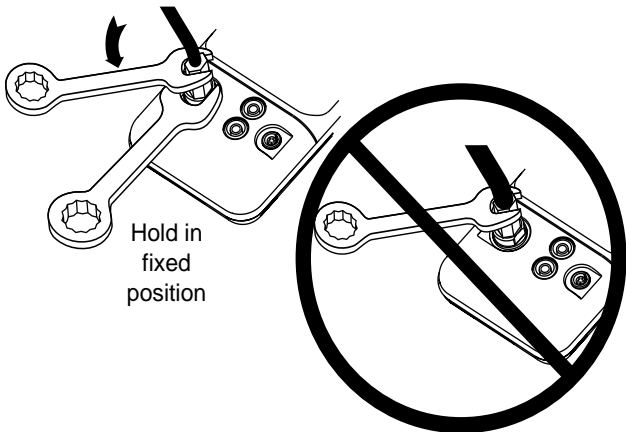

## **Contacting Fluke**

To contact Fluke for product information, operating assistance, service, or to get the location of the nearest Fluke distributor or service center, call:

1-888-99-FLUKE (1-888-993-5853) in U.S.A

1-800-36-FLUKE in Canada

+31-402-678-200 in Europe

+81-3-3434-0181 Japan

+65-738-5655 Singapore

+1-425-446-5500 from other countries

Or visit Fluke's web site at: [www.fluke.com](http://www.fluke.com).

Register your Calibrator at: <http://register.fluke.com>.

Address correspondence to:

Fluke Corporation  
P.O. Box 9090,  
Everett, WA 98206-9090  
U.S.A.

Fluke Europe B.V.  
P.O. Box 1186,  
5602 BD Eindhoven  
The Netherlands

### **Limited Warranty & Limitation Of Liability**

This Fluke product will be free from defects in material and workmanship for 3 years from the date of purchase. This warranty does not cover fuses, disposable batteries, or damage from accident, neglect, misuse, alteration, contamination, or abnormal conditions of operation or handling. Resellers are not authorized to extend any other warranty on Fluke's behalf. To obtain service during the warranty period, contact your nearest Fluke authorized service center to obtain return authorization information, then send the product to that Service Center with a description of the problem.

THIS WARRANTY IS YOUR ONLY REMEDY. NO OTHER WARRANTIES, SUCH AS FITNESS FOR A PARTICULAR PURPOSE, ARE EXPRESSED OR IMPLIED. FLUKE IS NOT LIABLE FOR ANY SPECIAL, INDIRECT, INCIDENTAL OR CONSEQUENTIAL DAMAGES OR LOSSES, ARISING FROM ANY CAUSE OR THEORY. Since some states or countries do not allow the exclusion or limitation of an implied warranty or of incidental or consequential damages, this limitation of liability may not apply to you.

## Getting Acquainted

Press **Ⓞ** to turn the Calibrator ON and OFF. The Calibrator displays pressure and current measurements simultaneously.







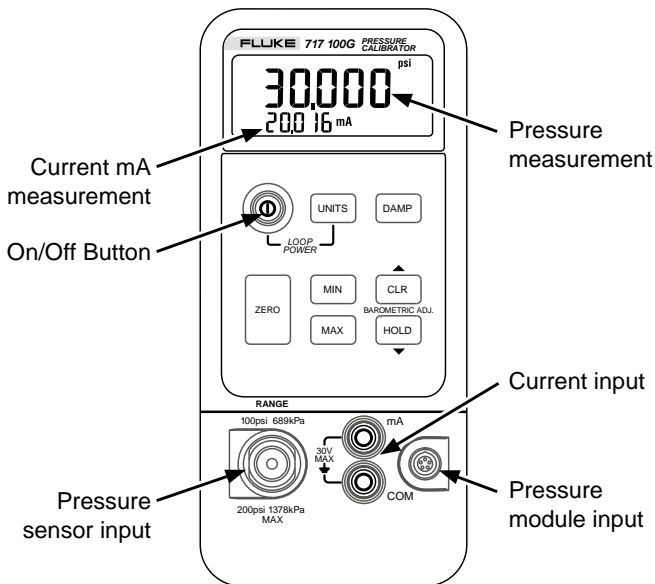





The upper part of the display shows the applied pressure.

Press **UNITS** to select a different unit. When you turn the Calibrator OFF, the next time you turn the Calibrator back ON it returns to the pressure unit you last used.

The lower part of the display shows the current (up to 24 mA) applied to the current (mA) inputs. The current inputs are fused with a 0.125 A, 250 V fast fuse (Littelfuse® type 2AG).









## Pushbutton Functions

Button	Function
	Press to select a pressure unit. All units are available when the pressure sensor input is used. For higher pressure module inputs, inappropriate units are not available.  Press  on while pressing  to source loop voltage.
	Press to toggle pressure reading damping on and off. With damping on, the display does not update as quickly.
	Press to zero the pressure display. (Vent pressure to atmosphere before pressing.)  With an absolute pressure module, see instructions below.
	Press and hold to read the minimum pressure and current readings since power was turned on or  was pressed.
	Press and hold to read the maximum pressure and current readings since power was turned on or  was pressed.
	Press to clear the MIN and MAX memories.  In ZERO mode, press to increase barometric pressure.
	Press  to freeze the display.  The <b>HOLD</b> symbol appears on the display. Press  again to resume normal operation.  In ZERO mode, press to decrease barometric pressure.

## Zeroing with Absolute Pressure Modules

To zero, adjust the Calibrator to read a known pressure as follows:

1. Press and hold .
2. Press  (  ) to increase or  (  ) to decrease the Calibrator reading to equal the applied pressure.
3. Release  to exit the zeroing procedure.

For all but the 700PA3 module, the known pressure can be barometric, if it is accurately known. An accurate pressure standard can also apply a pressure within range for any absolute pressure module. To convert measurement units:

- 1 bar = 750 mmHg (1 mmHg = 0.0013332 bar)
- 1 psi = 2.036 inHg (1 inHg = 0.49115 psi).

## Sourcing Loop Voltage

To use the Calibrator to supply loop power (24 V dc) to a current transmitter that is disconnected from the system:

1. With power off, hold down **UNITS** while pressing **ON**.  
**LOOP** appears in the display.
2. With the transmitter disconnected from normal loop power, connect the Calibrator in series with the instrument current loop as shown below.  
**LOOP** disappears from the display once the transmitter starts drawing current.
3. Measure loop current in the mA measurement display.
4. Press **OFF** to deactivate the 24 V dc supply when you are done sourcing loop voltage.

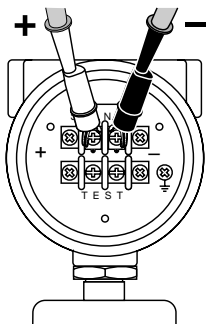



## Calibrating a P/I Transmitter

To calibrate a P/I (pressure to current) transmitter:

1. Open the pump vent and zero the Calibrator before applying pressure. Repeat frequently to ensure accuracy.
2. Apply a pressure to the transmitter and measure the transmitter's current loop output. **OL** (overload) is displayed at 100 psi.
3. Connect the Calibrator to the transmitter as shown in the figure "Connecting to an Internal Pressure Sensor" or "Connecting to a Pressure Module". The Calibrator recognizes only the pressure module if both types of connection are in place.

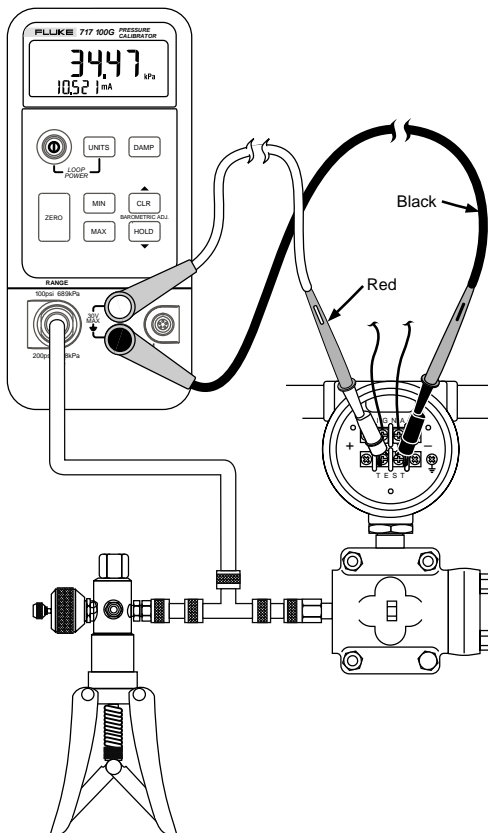

Connecting to an Internal Pressure Sensor

## Calibrating a P/I Transmitter (Cont.)

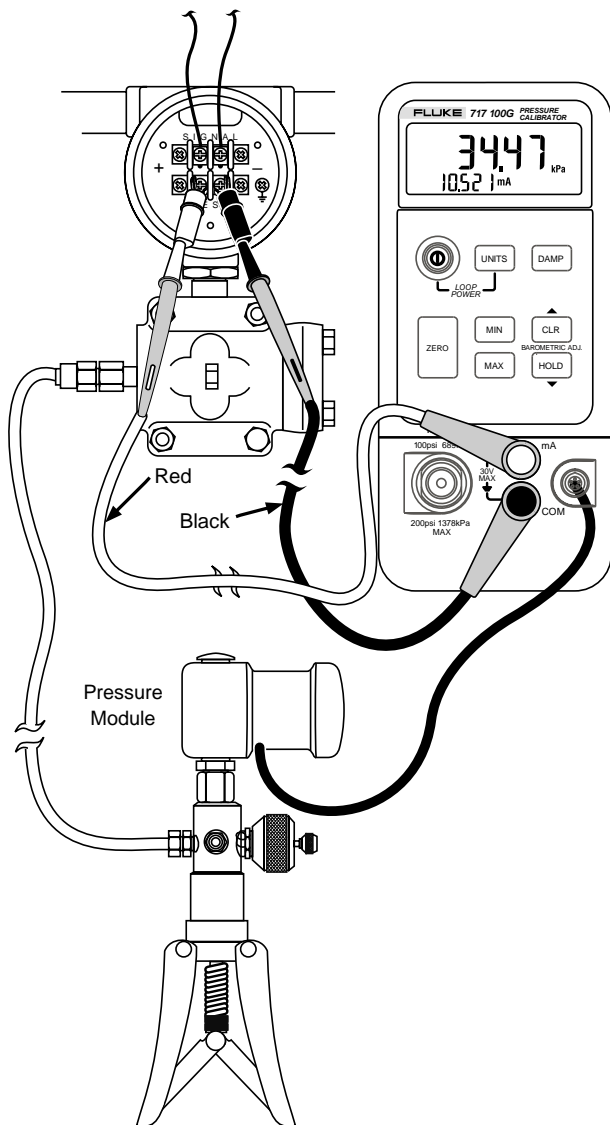

Connecting to a Pressure Module

## ***Maintenance***

### **⚠ Warning**

To avoid electric shock, personal injury, or damage to the Calibrator:

- **Do not service this product other than as described in this Instruction Sheet unless you are a qualified technician and have the required equipment and service information.**
- **Remove any input signals prior to removing test leads and opening case.**
- **When servicing the Calibrator, use only specified replacement parts.**
- **Do not allow water to get in the case.**

For maintenance procedures not described in this Instruction Sheet, contact a Fluke Service Center.

### ***In Case of Difficulty***

- Check the battery, test leads, and pressure tubing. Replace as necessary.
- Review this Instruction Sheet to make sure you are using the Calibrator correctly.

If the Calibrator needs repair, and the Calibrator is under warranty, see the warranty statement for terms. If the warranty has lapsed, the Calibrator will be repaired and returned for a fixed fee.

### ***Cleaning***

Periodically wipe the case with a damp cloth and detergent; do not use abrasives or solvents.

### ***Calibration***

Calibrate your Calibrator yearly to ensure that it performs to specification. A Calibration Manual (Fluke PN 686540) is available.

## Replacing the Battery

### Warning

To avoid false readings, which could lead to electric shock or injury, replace the battery as soon as  (low battery indicator) appears on the display.

Use only a single 9 V battery, properly installed, to power the Calibrator.

The Calibrator uses a single 9 V, alkaline battery (ANSI/NEDA 1604A or IEC 6LR61).

To replace the battery:

1. Turn the Calibrator OFF and remove the test leads from the terminals.
2. Remove Calibrator from its holster.
3. Remove the battery door on the back of the Calibrator as shown.
4. Lift the battery from the battery receptacle.
5. Attach the replacement battery to the leads, place the battery back in the battery receptacle.
6. Secure the battery door.
7. Return the Calibrator to its holster.

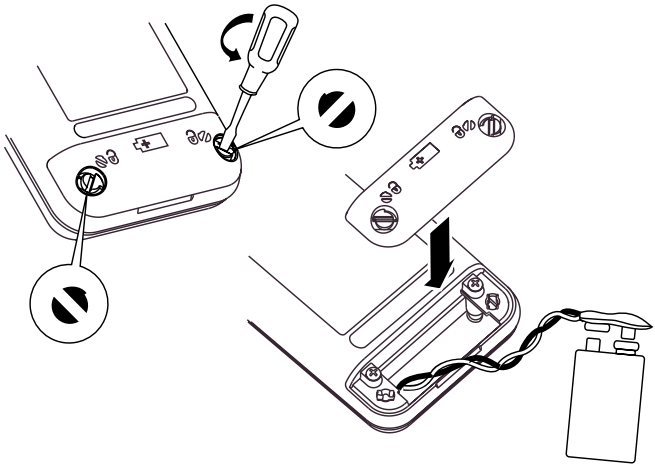

## Replacing the Fuse

### Warning

To avoid personal injury or damage to the Calibrator, use only a 0.125 A 250 V fast fuse, Littelfuse® type 2AG.

1. Turn the Calibrator OFF and remove the test leads.
2. Remove the battery door.
3. Remove the three Phillips-head screws from the case bottom and turn the case over.
4. Gently lift the top cover from the end nearest the current (mA) inputs until it unsnaps from the bottom cover.
5. Replace the fuse with a 0.125 A 250 V fast fuse, Littelfuse® type 2AG (Fluke PN 686527).
6. Fit the case top and circuit board assembly together, making sure that the O-ring is properly seated between the pressure sensor and the pressure fitting on the case top.
7. Fit the case bottom onto the case top, engaging the two snaps near the display end of the case. Reinstall the three screws.
8. Replace the battery door.

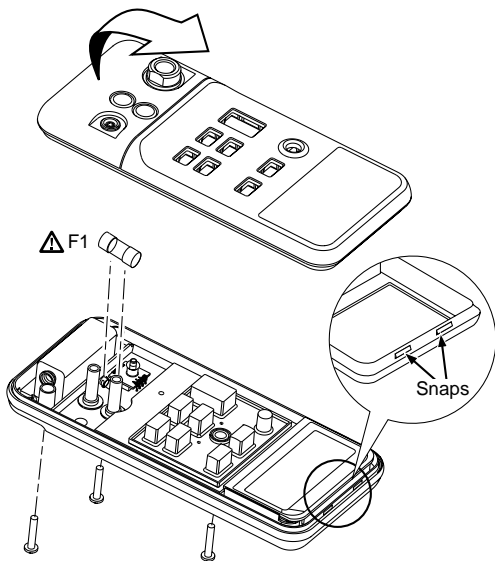

## Replacement Parts and Accessories

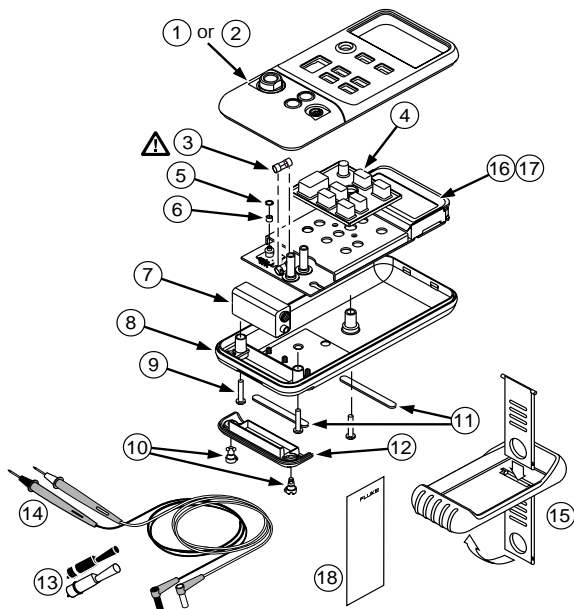

gc004f.eps

Part or Accessory	No.	Qty
1 717 30G case top	690997	1
2 717 100G case top	1640322	1
3  Fuse, 125 mA, 250 V fast, Littelfuse® type 2AG	686527	1
4 Keypad	687068	1
5 Spacer for pressure input	687449	1
6 O-ring for pressure input	146688	1
7 9 V battery, ANSI / NEDA 1604A or IEC LR61	614487	1
8 Case bottom	620168	1
9 Case screw	832246	3
10 Battery door fasteners	948609	2
11 Non-skid foot	824466	2
12 Battery door	609930	1
13 Alligator clips	AC70A	1
14 Test lead set	TL75	1
15 Holster, Yellow	CG81Y	1
16 717 30G LCD Bezel	663997	1
17 717 100G LCD Bezel	1638728	1
18 Instruction sheets (14)	690013	--

## Specifications

Accuracy is specified for 1 year after calibration at operating temperatures of  $-10\text{ }^{\circ}\text{C}$  to  $+55\text{ }^{\circ}\text{C}$ .

### Pressure Display, Pressure Sensor Input

Range	Accuracy
<b>717 30G:</b> -12 to 30 psi ( $-82.7$ to $206.84$ kPa)	$\pm 0.05\%$ of range
<b>717 100G:</b> -12 to 100 psi ( $-82.7$ to $689.5$ kPa)	
<b>717 30G Maximum nondestructive pressure:</b> To 3 times top of range (90 psi, 620 kPa, 6.2 bar).	
<b>717 100G Maximum nondestructive pressure:</b> To 2 times top of range (200 psi, 1379 kPa, 13.8 bar).	
<b>Temperature coefficient:</b> 0.01 % of range per $^{\circ}\text{C}$ for temperature ranges of between $-10\text{ }^{\circ}\text{C}$ to $18\text{ }^{\circ}\text{C}$ and $28\text{ }^{\circ}\text{C}$ to $55\text{ }^{\circ}\text{C}$ .	

### Pressure Display, Pressure Module Input

Range	Resolution	Accuracy
Refer to the Instruction Sheet for the pressure module		

### DC mA Input

Range	Resolution	Accuracy, $\pm$ ( % of Reading + Counts)
24 mA	0.001 mA	0.025 + 1
<b>Overload protection:</b> 125 mA, 250 V fast acting fuse		
<b>Temperature coefficient:</b> 0.005 % of range per $^{\circ}\text{C}$ for temperature ranges of between $-10\text{ }^{\circ}\text{C}$ to $18\text{ }^{\circ}\text{C}$ and $28\text{ }^{\circ}\text{C}$ to $55\text{ }^{\circ}\text{C}$ .		

### Loop Supply

24 V dc nominal

## **General Specifications**

**Maximum voltage applied between either an mA terminal and earth ground or between the mA terminals:**

30 V

**Storage temperature:**

-40 °C to 60 °C

**Operating temperature:**

-10 °C to 55 °C

**Operating altitude:**

3000 meters maximum

**Relative humidity:**

95 % up to 30 °C;

75 % up to 40 °C;

45 % up to 50 °C;

35 % up to 55 °C

**Vibration:**

Random 2 g, 5 Hz to 500 Hz

**Shock:**

1 meter drop test

**Safety Compliance:**

IEC 61010-1-95 CAT I, 30 V;

CSA C22.2 No. 1010.1-92 NRTL;

ANSI/ISA S82.01.

**CE:**

Complies with EN 61326 Class A; EN61010-1

**Power requirements:**

Single 9 V battery (ANSI/NEDA 1604A or IEC 6LR61)

**Size:**

34.9 mm H x 87 mm W x 187 mm L

(1.55 in H x 3.41 in W x 7.35 in L);

With holster and Flex-Stand: 52 mm H x 98 mm W x 201 mm L

(2.06 in H x 3.86 in W x 7.93 in L)

**Weight:**

369 g (13 oz);

With holster and Flex-Stand: 624 g (22 oz)