

Datasheet

Side mount grabber door catch, 13N pull

RS Stock No: 1611954

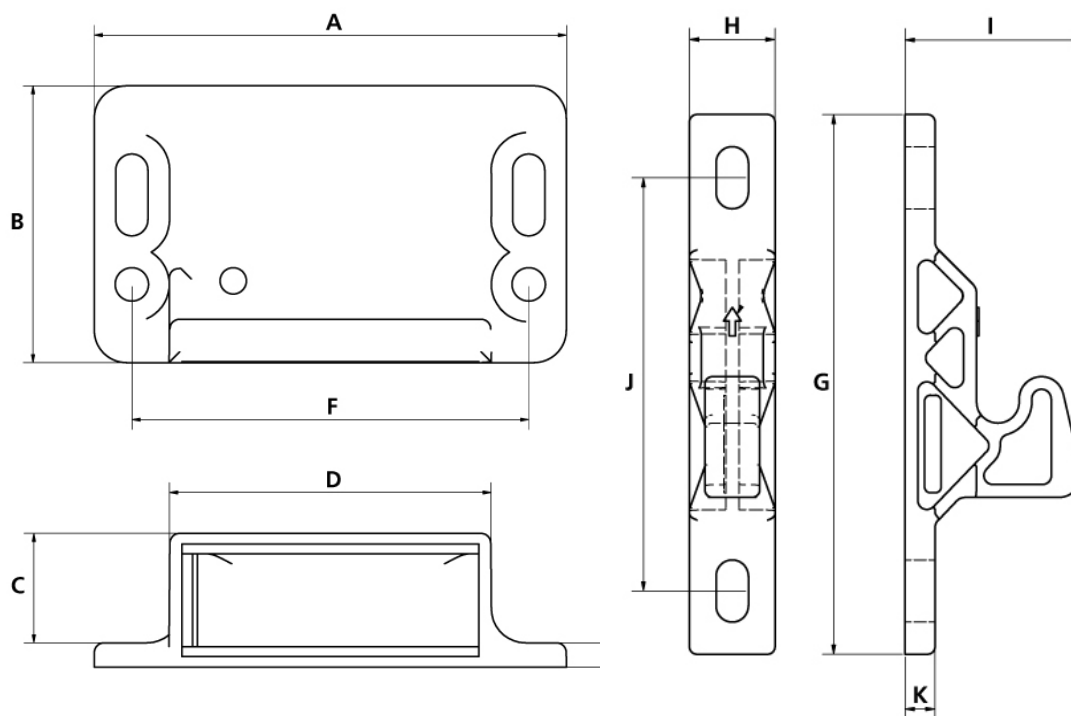



ENGLISH

Specification

Reinforced Nylon

Can be screwed or riveted to door/frame

Mounts inside enclosure

Heavy duty keeper

Push to close, pull to open

Spring loaded over centre action

Available in three pull forces

Part Number	A	B	C	D	E	F	Bore Size (Diam or Dimensions)	Pull Force (N)
1611954	48	28	11	33	2.5	40.5	3.4, 3.4 x 8.4	13

Part Number	G	H	I	J	K	Bore Size
1611954	72	11.4	23.5	55	4	4.3 x 8.3