



ENGLISH
ITALIANO
DEUTSCHE
FRANÇAIS
ESPAÑOL
PORTUGUÊS

Datasheet

TECHNOPOLYMER PUSH-IN FITTING

RACCORDI AUTOMATICI IN TECNOPOLIMERO

KUNSTSTOFF STECKVERSCHRAUBUNGEN

RACCORDS INSTANTANÉS EN TECNOPOLYMÈRE

RACORDAJE AUTOMÁTICO EN TECNOPOLÍMERO

CONEXÕES PUSH-IN EM TECNOPOLÍMERO



IT

Gamma completa dal diam. 2 al 14 mm.

Principali vantaggi

- Connessione e sconnessione istantanea
- Pieno passaggio e tenuta al vuoto grazie a guarnizioni sagomate
- Tre tipologie di filettature, BSPP, BSPT (universal short) e Metrica
- Compattezza e riduzione dei pesi
- Gamma con figure specifiche per soddisfare la robotica più spinta
- Silicon Free

Applicazioni

- Robotica
- Automotive
- Industria tessile, imballaggio, manipolazione
- Circuiti aria compressa
- Acqua industriale
- Vuoto

GB

Wide Range \varnothing 2 - 14 mm.

Main advantages

- Quick connection and disconnection
- Full Flow and Vacuum resistant tank to special shaped seals
- 3 threads available, BSPP, BSPT (universal short) & Metric
- Lighter and More compact
- Specific configurations to satisfy the advanced robotics
- Silicon Free

Applications

- Robotics
- Automotive
- Textile, Packaging, Handling
- Compressed Air Circuit
- Industrial Water
- Vacuum

DE

Liefersortiment \varnothing 2 - 14 mm.

Hauptvorteile

- Schnelle Verbindung und Trennung
- Voller Durchfluss und Vakuumfestigkeit, dank spezieller Formdichtungen
- Drei Gewindearten, BSPP, BSPT (universal kurz) und metrisch
- Leichter und kompakter
- Spezielle Konfigurationen, um der fortschrittlichen Robotertechnik gerecht zu werden
- Silikonfrei

Anwendungen

- Robotik
- Automobil-Industrie
- Textil-, Verpackungs-, Handlingindustrie
- Druckluftkreislauf
- Industrielle Wasser
- Vakuum

FR

Large gamme \varnothing 2 - 14 mm.

Principaux avantages

- Connexion et déconnexion rapides
- Plein débit et tenue au vide grâce à des joints de forme
- 3 filetages disponibles, BSPP, BSPT (universel court) et métrique
- Légèreté et compacité
- Configurations spécifiques pour répondre à la robotique de pointe
- Sans silicone

Applications

- Robotique
- Automobile
- Textile, Conditionnement, Manutention
- Circuit Air comprimé
- Eau industrielle
- Vide industriel

ES

Amplia gama de \varnothing 2 - 14 mm.

Principales ventajas

- Conexión y desconexión instantánea
- Paso total y estanqueidad al vacío gracias a las juntas moldeadas
- Tres tipos de roscas, BSPP, BSPT (universal short) y métricas
- Ligero y más compacto
- Configuraciones específicas para satisfacer la robótica avanzada
- Libre de silicona

Aplicaciones

- Automatización Neumática
- Automoción
- Industria textil, envasado, manipulación
- Circuitos de aire comprimido
- Agua Industrial
- Vacío

PT

Grande range de itens : \varnothing 2 - 14 mm.

Principais vantagens

- Rápida conexão e desconexão
- Vazão total e resistência ao vácuo graças ao design de suas vedações
- 3 tipos de rosca disponíveis: BSPP, BSPT (universal short) & Métrica.
- Leveza e compacidade
- Configurações específicas para atender robótica avançada
- Livre de Silicone

Aplicações

- Robótica
- Automotiva
- Têxtil, Embalagem, Manipulação
- Circuitos de Ar Comprimido
- Água Industrial
- Vácuo



CARATTERISTICHE TECNICHE
 TECHNICAL CHARACTERISTICS
 TECHNISCHE ANGABEN
 CARACTÉRISTIQUES TECHNIQUES
 CARACTERÍSTICAS TÉCNICAS
 CARACTERÍSTICAS TÉCNICAS



Norma di Riferimento
 Reference standard
 Entspricht der Norm
 Norme de référence
 Normativa de referencia
 Norma de referència

1907/2006
REACH

2011/65/CE
RoHS

PED
 2014/68/UE

ISO
 14743:2004

**SILICON
 FREE**

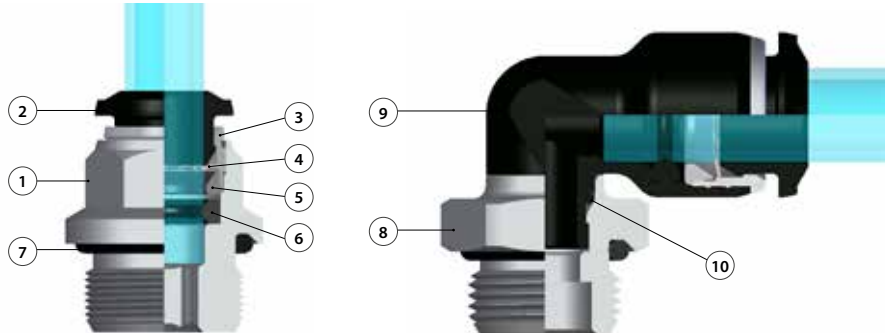

Materiali e Componenti	IT	Component Parts and Materials	GB	Komponenten und Materialien	DE
1	Corpo in ottone nichelato	1	Nickel-plated brass Body	1	Körper Messing vernickelt
2	Spintore sgancio tubo resina acetalica	2	Acetalic resin Collet	2	Rohr Lösering Acetal
3	Capsula in ottone nichelato	3	Nickel-plated brass Capsule	3	Haltering Messing vernickelt
4	Pinza d'aggraffaggio in acciaio inox AISI 301	4	Steel AISI 301 Clamping washer	4	Zahnscheibe Edelstahl AISI 301
5	Anello di posizionamento in tecnopolimero	5	Technopolymeric positioning ring	5	Positioniering Technopolymer
6	Guarnizione sagomata in NBR	6	NBR Molded seal	6	Lippendichtung NBR
7	Guarnizione filetto in NBR	7	NBR Thread packing	7	Gewindeabdichtung NBR
8	Basetta Filettata in Ottone Nichelato	8	Base Threaded Nickel Plated Brass	8	Gewindebasis Messing vernickelt
9	Corpo in tecnopolimero PA	9	Technopolymeric Body PA	9	Körper Technopolymer PA
10	Guarnizione in NBR	10	NBR seal	10	Lippendichtung NBR

Matériaux et Composants	FR	Materiales y Componentes	ES	Materiais e Componentes	PT
1	Corps: Laiton nickelé	1	Cuerpo en latón niquelado	1	Corpo em latão niquelado
2	Poussoir: Résine acétal	2	Anillo de extracción tubo en resina acetálica	2	Anilha de liberação do tubo em resina acetálica
3	Capsule de retenue: Laiton nickelé	3	Cápsula en latón niquelado	3	Cápsula de latão niquelado
4	Rondelle d'accrochage: AISI 301	4	Pinza de agarre en acero inox AISI 301	4	Pinça de travamento em aço-inox AISI 301
5	Anneau de positionnement: Technopolymère	5	Anillo de posicionamiento en tecnopolimero	5	Anel de posicionamento em tecnopolimero
6	Joint à lèvres: NBR	6	Junta de forma en NBR	6	Vedação em NBR
7	Joint d'étanchéité du filetage: NBR	7	Junta rosca en NBR	7	Vedação da rosca em NBR
8	Bague de sécurité en laiton nickelé	8	Base roscada en latón niquelado	8	Base roscada en latão niquelado
9	Corps: Technopolymère PA	9	Cuerpo en tecnopolimero PA	9	Corpo em tecnopolimero PA
10	Joint en NBR	10	Junta en NBR	10	Vedação em NBR



Pressioni

Pressures
 Druckbereich
 Pressions
 Presiones
 Pressões

- 0.99 bar (-0.099 MPa)
20 bar (2.0 MPa)



Temperature

Temperatures
 Temperatur
 Temperaturas
 Temperaturas
 Temperaturas

- 20 °C
+ 80 °C



Fluidi compatibili

Aria compressa / Vuoto / Acqua

Fluids
 Compressed air / Vacuum / Water

Geeignete Medien
 Druckluft / Vakuum / Wasser

Fluides compatibles
 Air comprimé / Vide / Eau

Fluidos compatibles
 Aire comprimido / Vacío / Agua

Fluidos compatíveis
 Ar comprimido / Vácuo / Água



Tubi di Collegamento	IT	Connection Tubes	GB	Geeignete Rohre	DE
Tubi in materiale plastico: PA6, PA11, PA12, Polietilene, *Poliuretano, PTFE, FEP. *Per tubi in Poliuretano è consigliata una durezza di 98 shore.		Plastic tubes: PA6, PA11, PA12, Polyethylene, *Polyurethane, PTFE, FEP. *For Polyurethane hoses it is required a minimum hardness of 98 shore.		Kunststoffrohre: PA6, PA11, PA 12, Polyethylene, *Polyurethan, PTFE, FEP. *Für Polyurethan Rohre ist eine Härte von 98 Shore empfohlen.	

Tubes Conseillés	FR	Tubos de Conexión	ES	Tubos de Conexão	PT
Tubes plastiques: PA6, PA11, PA12, Polyéthylène, *Polyuréthane, PTFE, FEP. *Pour les tubes en polyuréthane, il est conseillé une dureté de 98 Shore.		Tubos en material plástico: PA6, PA11, PA 12, Polietileno, *Poliuretano, PTFE, FEP. *Para tubos en poliuretano es aconsejada una dureza de 98 shore.		Tubos em material plástico: PA6, PA11, PA12, Polietileno, *Poliuretano, PTFE, FEP. *Para tubos em Poliuretano é requerida uma dureza de 98 shore.	



<p>Filettatura IT</p> <p>Gas conica "UNIVERSAL SHORT". Gas conica conforme ISO 7.1, BS 21, DIN 2999. Gas cilindrica conforme ISO 228 Classe A. Metrica conforme ISO R/262.</p>	<p>Threads GB</p> <p>"UNIVERSAL SHORT" Tapered thread. Tapered gas in conformity with ISO 7.1, BS 21, DIN 2999. Parallel gas in conformity with ISO 228 Class A. Metric in conformity with ISO R/262.</p>	<p>Gewindearten DE</p> <p>Konisches Gewinde "UNIVERSAL SHORT". Konisches Gewinde nach Norm ISO 7.1, BS 21, DIN 2999. Zylindrisches Gewinde nach Norm ISO 228 Classe A. Metrisches Gewinde nach Norm ISO R/262.</p>
<p>Filetages FR</p> <p>Filetage conique "UNIVERSAL SHORT". Filetage conique conforme: ISO 7.1, BS 21, DIN 2999. Filetage cylindrique conforme: ISO 228 Class A. Filetage métrique conforme: ISO R/262.</p>	<p>Roscas ES</p> <p>Gas cónica "UNIVERSAL SHORT". Gas cónica conforme ISO 7.1, BS 21, DIN 2999. Gas cilíndrica conforme ISO 228 Clase A. Métrica conforme ISO R/262.</p>	<p>Roscas PT</p> <p>Gas cónica "UNIVERSAL SHORT". Gas cónica conforme ISO 7.1, BS 21, DIN 2999. Gas paralela conforme ISO 228 Classe A. Métrica conforme ISO R/262.</p>



UNIVERSAL SHORT

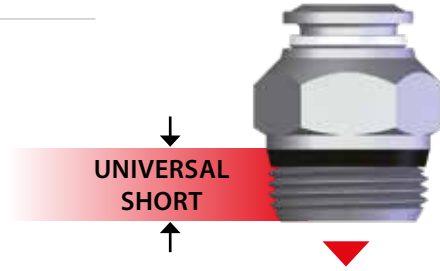

<p>NPT NPTF</p> <p>Conica Tapered Konisch Conique Cónica Cônica</p>	<p>ISO 7 BSPP</p> <p>Cilíndrica Paralell Zylindrisch Cylindrique Cilíndrica Paralela</p>	<p>ISO 7 BSPT PT</p> <p>Conica Tapered Konisch Conique Cónica Cônica</p>	<p>ISO 228 BSP PF</p> <p>Cilíndrica Paralell Zylindrisch Cylindrique Cilíndrica Paralela</p>
---	--	---	---

<p>"UNIVERSAL SHORT" IT</p> <p>La filettatura conica "UNIVERSAL SHORT" è progettata per soddisfare le seguenti caratteristiche:</p> <ul style="list-style-type: none"> • ridurre la lunghezza d'ingombro; • ridurre la chiave rispetto ad alcuni raccordi con filettature cilindriche; • consentire l'accoppiamento con diversi standard di filettature femmina sia coniche che cilindriche. 	<p>"UNIVERSAL SHORT" GB</p> <p>The "UNIVERSAL SHORT" taper thread has been designed to offer the following advantages to the users:</p> <ul style="list-style-type: none"> • reduced overall length; • smaller hex dimensions compared to the parallel threads; • to allow the assembly with different female threads both taper as well as parallel. 	<p>"UNIVERSAL SHORT" DE</p> <p>Das konische Gewinde "UNIVERSAL SHORT" ist so konzipiert, dass folgende Vorteile erzielt werden:</p> <ul style="list-style-type: none"> • Reduzierung der Länge des Gewindes - kürzere Montagezeit; • Reduzierung der Schlüsselweite im Vergleich von Verschraubungen mit zylindrischen Gewinden - geringerer Lochabstand; • Ermöglicht den Einsatz in verschiedene Gewindearten, sowie in konische- und zylindrische Innengewinde.
<p>"UNIVERSAL SHORT" FR</p> <p>Le filetage conique "UNIVERSAL SHORT" a été conçu pour satisfaire les exigences suivantes:</p> <ul style="list-style-type: none"> • réduire la longueur d'encombrement; • réduire les dimensions hexagonales par rapport au filetage cylindrique; • permettre le montage avec divers taraudages standards soit coniques soit cylindriques. 	<p>"UNIVERSAL SHORT" ES</p> <p>La rosca cónica "UNIVERSAL SHORT" ha sido proyectada para satisfacer las siguientes características:</p> <ul style="list-style-type: none"> • reducir la longitud; • reducir la llave respecto a algunos racores con rosca cilíndrica; • permitir el acoplamiento con diferentes standard de rosca hembra sean cónicas o cilíndricas. 	<p>"UNIVERSAL SHORT" PT</p> <p>A rosca cónica "UNIVERSAL SHORT" é projetada para satisfazer às seguintes características:</p> <ul style="list-style-type: none"> • reduzir o comprimento da conexão; • reduzir o dimensional com relação às rosca paralelas; • permitir o acoplamento da conexão a diferentes tipos de rosca fêmea, sejam elas cónicas ou paralelas.



Inclinate
Inclined
Geneigt
Incliné
Inclinada
Inclinadas



Concave
Concave
Konkav
Concave
Cóncava
Côncavas



Convex
Convex
Konvex
Convexe
Convexa
Convexas

<p>IT</p> <p>Consentire una completa tenuta anche su superfici non perfettamente piane, concave, convesse o inclinate, con diversi smussi o raggi.</p>	<p>GB</p> <p>To ensure the right tightening also with surfaces not perfectly flat, without spot-facing, concave convex and with different kinds of chamfers or radius.</p>	<p>DE</p> <p>Eine vollständige Abdichtung ist auch auf unebenen Flächen, wie geneigt, konkav oder konvex und mit unterschiedlichen Radien oder Fasen gewährleistet.</p>
<p>FR</p> <p>Pour permettre une parfaite étanchéité même sur des surfaces non planes, concaves, convexas ou inclinées et avec différents chanfreins ou rayons.</p>	<p>ES</p> <p>Consentir una completa estanqueidad incluso en superficies no perfectamente planas, cóncavas, convexas o inclinadas, con diferentes ángulos o radios.</p>	<p>PT</p> <p>Permite um aperto correto em superfícies não perfeitamente planas, côncavas, convexas ou inclinadas, com diferentes chanfros ou raios.</p>



Coppia di serraggio

Torque specifications

Angaben Drehmoment

Couple de serrage

Par de apriete

Especificações de Torque



ISO 228



"UNIVERSAL SHORT"

MISURA MEASURE GRÖSSE DIMENSIONS MEDIDA MEDIDA	COPPIA CONSIGLIATA Nm RECOMMENDED TORQUE Nm EMPFOHLENES DREHMOMENT Nm COUPLE DE SERRAGE Nm PAR ACONSEJADO Nm TORQUE RECOMENDADO Nm	COPPIA DI ROTTURA Nm BREAKING TORQUE Nm ABSCHERDREHMOMENT Nm COUPLE DE RUPTURE Nm PAR DE ROTURA Nm TORQUE DE RUPTURA Nm
M5	0,8	3,2
1/8	3	8
1/4	9	30
3/8	10	60
1/2	12	50

MISURA MEASURE GRÖSSE DIMENSIONS MEDIDA MEDIDA	COPPIA MINIMA CONSIGLIATA Nm RECOMMENDED MINIMUM TORQUE Nm EMPFOHLENES DREHMOMENT Nm COUPLE DE SERRAGE Nm PAR MÍNIMO ACONSEJADO Nm TORQUE MÍNIMO RECOMENDADO Nm	COPPIA MASSIMA CONSIGLIATA Nm RECOMMENDED MAX TORQUE Nm ABSCHERDREHMOMENT Nm COUPLE DE RUPTURE Nm PAR MÁXIMO ACONSEJADO Nm TORQUE MÁXIMA RECOMENDADO Nm
1/8	5	7
1/4	5	7
3/8	5	7
1/2	5	7

I valori di rottura possono variare in base all'articolo
Breaking values may vary according to the item
Die maximal werte dienen nur zu Informationszwecken
Les valeurs maximales sont présentées à titre indicatif
Los valores de rotura pueden variar en función del artículo
Os valores de ruptura podem variar em função do item

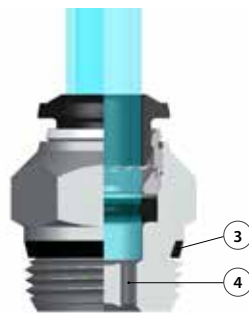
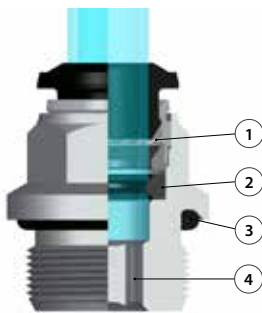

Vantaggi

IT

- 1 La pinza in acciaio inox garantisce il perfetto aggraffaggio di tubi di qualsiasi materiale senza danneggiarne la superficie. Il collegamento tra tubo e raccordo assicura una tenuta totale anche in condizioni di urti e vibrazioni.
- 2 La particolare geometria della guarnizione permette inoltre l'utilizzo dei raccordi anche con il vuoto.
- 3 Tutte le filettature di questa serie sono state dotate di elementi di tenuta che permettono l'immediato utilizzo dei raccordi riducendo notevolmente i tempi di installazione.
- 4 Tutti i raccordi dritti possono essere montati anche con chiave esagonale ed è possibile utilizzarli anche in spazi molto ridotti.

Advantages

GB

- 1 The washer is made in stainless steel ensures the perfect tube clamping with every kinds of materials without damage the surface. The connection between the tube and the fitting ensure a total tightness even in severe conditions such as impact and vibrations.
- 2 The particular geometric shape of the seal ensure the perfect tightness even with vacuum.
- 3 All of threads from this range have been equipped with tightening parts which allow the direct assembly of the fittings, reducing the installation time.
- 4 All the straight fittings can be assembled also with Allen wrench and it is possible to use them in reduced spaces.

Vorteile

DE

- 1 Konisches Gewinde "kurz" Die Zahnscheibe sorgt für eine perfekte Halterung des Rohres ohne die Oberfläche zu beschädigen. Die Dichtheit zwischen Rohr und Verschraubung ist auch bei Erschütterungen und Vibrationen gewährleistet.
- 2 Die besondere Geometrie der Dichtung ermöglicht auch die Anwendung der Verschraubungen in Verbindung mit Vakuum.
- 3 Alle Verschraubungen in dieser Serie sind mit Gewindeabdichtungen ausgestattet, die den sofortigen Einsatz ermöglichen und daher die Montagezeit stark reduzieren.
- 4 Alle geraden Verschraubungen können auch mit Inbusschlüsseln montiert werden, daher kleiner Lochabstand möglich.

Avantages

FR

- 1 La rondelle en acier inoxydable garantit la parfaite tenue du tube quelle que soit la matière et sans l'endommager. La connexion entre le tube et le raccord assure une étanchéité totale même dans des conditions d'impact ou de vibrations.
- 2 La spécificité géométrique du joint permet l'utilisation des raccords avec le vide.
- 3 Tous les filetages de cette série sont équipés d'éléments d'étanchéité qui permettent l'utilisation immédiate des raccords réduisant ainsi le temps d'installation.
- 4 Tous les raccords droits peuvent être aussi montés avec une clé hexagonale pour permettre une utilisation dans des espaces réduits.

Ventajas

ES

- 1 La pinza en acero inox garantiza el perfecto agarre del tubo de cualquier material sin perjudicar la superficie. La conexión entre tubo y racor asegura una estanqueidad total aun en condiciones de impacto o vibración.
- 2 La particular geometría de la junta garantiza una perfecta estanqueidad incluso en vacío.
- 3 Todas las rosas de esta serie están fabricadas con junta de cierre que permite la inmediata utilización del racor reduciendo notablemente el tiempo de instalación.
- 4 Todos los racores rectos pueden montarse también con llave hexagonal y es posible utilizarlos incluso en espacios muy reducidos.

Vantagens

PT

- 1 A pinça em aço-inox garante o perfeito travamento do tubo de qualquer material sem danificar a superfície do mesmo. A conexão entre o tubo e a conexão assegura uma vedação total também em condições de impactos e vibrações.
- 2 A geometria particular da vedação permite a utilização da conexão também para aplicações com vácuo.
- 3 Todas as rosas desta série são dotadas de elementos de vedação, o que permite a imediata utilização das conexões, reduzindo notavelmente o tempo de instalação.
- 4 Todas as conexões retas podem ser montadas também com chave allentando possível montagem das mesmas em espaços bem reduzidos.

STRAIGHT MALE ADAPTOR "UNIVERSAL SHORT"

RACCORDO DIRITTO MASCHIO "universal SHORT"

GERADE EINSCHRAUBVERSCHRAUBUNG KONISCH "universal SHORT"
 RACCORD DROIT MÂLE, CONIQUE "UNIVERSAL SHORT"
 RACOR RECTO MACHO CÓNICO "UNIVERSAL SHORT"
 CONEXÃO RETA COM ROSCA "UNIVERSAL SHORT"

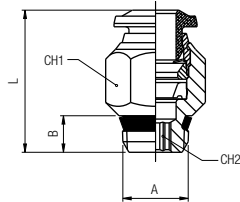

Code	Tube	A	B	L	CH1	CH2	Pack.
176-1313	4	1/8	5.5	18	11	3	10
176-1320	4	1/4	7	19	14	3	10
176-1314	6	1/8	5.5	21.5	13	4	10
176-1315	6	1/4	7	21	14	4	10
176-1321	6	3/8	7.5	23	17	4	10
176-1322	6	1/2	9	23.5	21	4	10
176-1316	8	1/8	5.5	24.5	14	5	10
176-1317	8	1/4	7	22	14	6	10
176-1319	8	3/8	7.5	23	17	6	10
176-1323	8	1/2	9	23.5	21	6	10
176-1788	10	1/4	7	28	17	7	10
176-1789	10	3/8	7.5	25.5	17	8	10
176-1792	10	1/2	9	26	21	8	10
176-1790	12	1/4	7	31.5	20	7	10
176-1791	12	3/8	7.5	29.5	20	9	10
176-1793	12	1/2	9	31.5	21	10	10
176-1794	14	3/8	7.5	32.5	21	9	10
176-1795	14	1/2	9	31.5	21	10	10

STRAIGHT MALE ADAPTOR (PARALLEL)

RACCORDO DIRITTO MASCHIO CILINDRICO

GERADE EINSCHRAUBVERSCHRAUBUNG ZYLINDRISCH
 RACCORD DROIT MÂLE, CYLINDRIQUE
 RACOR RECTO MACHO CILÍNDRICO CON TÓRICA
 CONEXÃO RETA COM ROSCA PARALELA

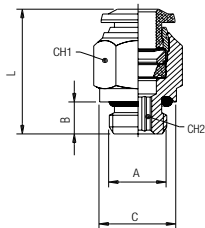

Code	Tube	A	B	C	L	CH1	CH2	Pack.
176-1275	4	1/8	6	13	20	10	3	10
176-1276	4	1/4	8	16	19.5	16	3	10
176-1283	5	M5	4	8	23.5	12	2	10
176-1282	6	1/8	6	13	23.5	13	4	10
176-1277	6	1/4	8	16	23.5	13	4	10
176-1278	6	3/8	9	20	25	13	4	10
176-1284	6	1/2	10	25	27	13	4	10
176-1285	8	1/8	6	13	25	14	5	10
176-1279	8	1/4	8	16	23	14	6	10
176-1280	8	3/8	9	20	24	14	6	10
176-1281	8	1/2	10	25	26.5	14	6	10
176-1286	10	1/4	8	16	30.5	17	6	10
176-1761	10	3/8	9	20	27.5	17	8	10
176-1762	10	1/2	10	25	27	17	8	10
176-1768	12	1/4	8	16	34.5	20	6	10
176-1769	12	3/8	9	20	34	20	8	10
176-1763	12	1/2	10	25	31	22	10	10
176-1765	14	3/8	9	20	35	21	10	10
176-1766	14	1/2	10	25	32	22	11	10
176-1767	6	M12x1	8	15	23.5	13	4	10

STRAIGHT FEMALE ADAPTOR

RACCORDO DIRITTO FEMMINA

AUFSCRAUBVERSCHRAUBUNG
 RACCORD DROIT, TARAUDE
 RACOR RECTO HEMBRA
 CONEXÃO RETA COM ROSCA FÊMEA

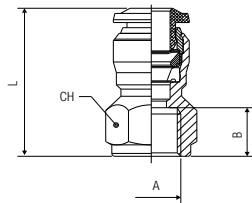

Code	Tube	A	B	L	CH	Pack.
176-1293	4	M5	5.5	21	11	10
176-1287	4	1/8	8.5	24	13	10
176-1294	4	1/4	11	27.5	16	10
176-1288	6	1/8	8.5	26	13	10
176-1290	6	1/4	11	29.5	16	10
176-1291	8	1/8	8.5	27	15	10
176-1292	8	1/4	11	29.5	17	10
176-1295	8	3/8	12	32	19	10
176-1770	10	1/4	11	32	18	10
176-1771	10	3/8	12	33.5	19	10
176-1772	10	1/2	15	39	24	10
176-1773	12	3/8	12	36	21	10
176-1774	12	1/2	15	41	24	10

STRAIGHT CONNECTOR RACCORDO DIRITTO INTERMEDIO

VERBINDUNGSVERSCHRAUBUNG
RACCORD UNION DOUBLE
RACOR RECTO INTERMEDIO
CONEXÃO RETA TUBO-TUBO

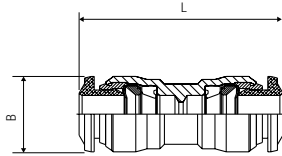

Code	Tube	Tube	L	B	Pack.
176-1325	4		31	10	10
176-1326	6		35	12,5	10
176-1328	6	4	34	12,5	10
176-1327	8		37	14	10
176-1331	8	4	37	14	10
176-1329	8	6	37	14	10
176-1796	10		45	17	10
176-1801	10	6	44	17	10
176-1799	10	8	44	17	10
176-1797	12		50	20	10
176-1802	12	8	50	20	10
176-1800	12	10	50	20	10
176-1798	14		48	21	10
176-1803	14	12	48	21	10

BULKHEAD CONNECTOR RACCORDO DIRITTO INTERMEDIO DI ATTRAVERSAMENTO

SCHOTTVERSCHRAUBUNG
RACCORD TRAVERSÉE DE CLOISON
RACOR RECTO INTERMEDIO PASATABIQUES
CONEXÃO PASSA-MURO RETA TUBO-TUBO

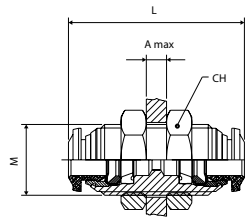

Code	Tube	M	L	CH	A max	Pack.
176-1296	4	M12x1	31.5	17	7	10
176-1297	6	M14x1	35	17	9.5	10
176-1298	8	M16x1	37	19	10.5	10
176-1775	10	M20x1	43	24	12.5	10
176-1776	12	M22x1	48	26	16.5	10
176-1777	14	M23x1	49	27	16.5	10

ORIENTING ELBOW MALE ADAPTOR "UNIVERSAL SHORT"

RACCORDO A L ORIENTABILE MASCHIO "universal SHORT"

WINKELVERSCHRAUBUNG KONISCH (DREHBAR) "universal SHORT"
EQUERRE ORIENTABLE MÂLE, CONIQUE "UNIVERSAL SHORT"
RACOR A L ORIENTABLE MACHO CÔNICO "UNIVERSAL SHORT"
CONEXÃO MACHO EM "L" ORIENTÁVEL COM ROSCA "UNIVERSAL SHORT"

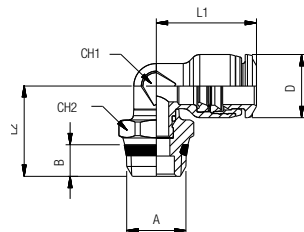

Code	Tube	A	B	L1	L2	CH1	CH2	D	Pack.
176-1332	4	1/8	5.5	16.5	16.5	7	13	10	10
176-1333	4	1/4	7	16.5	18	7	15	10	10
176-1334	6	1/8	5.5	20.5	17.5	9	13	12	10
176-1335	6	1/4	7	20.5	18.9	9	15	12	10
176-1336	6	3/8	7.5	20.5	20	9	17	12	10
176-1337	8	1/8	5.5	22	18.5	10	13	14	10
176-1338	8	1/4	7	22	20	10	15	14	10
176-1339	8	3/8	7.5	22	20.5	10	17	14	10
176-1804	10	1/4	7	26.5	21.8	13	16	17	10
176-1805	10	3/8	7.5	26.5	21.8	13	17	17	10
176-1806	10	1/2	9	26.5	24.3	13	21	17	10
176-1807	12	1/4	7	30	23.1	16	16	20	10
176-1808	12	3/8	7.5	30	23.1	16	17	20	10
176-1809	12	1/2	9	30	25.6	16	21	20	10
176-1810	14	3/8	7.5	31	26.5	18	20	21	10
176-1811	14	1/2	9	31	27	18	21	21	10

ORIENTING ELBOW MALE ADAPTOR (PARALLEL)
RACCORDO A L ORIENTABILE MASCHIO CILINDRICO

WINKELVERSCHRAUBUNG ZYLINDRISCH (DREHBAR)
 EQUERRE ORIENTABLE MÂLE, CYLINDRIQUE
 RACOR A L ORIENTABLE MACHO CILÍNDRICO CON TÓRICA
 CONEXÃO MACHO EM "L" ORIENTÁVEL COM ROSCA PARALELA

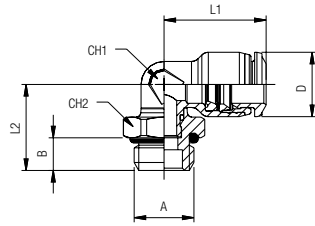

Code	Tube	A	B	L1	L2	CH1	CH2	D	Pack.
176-1340	4	M5	3.6	16.5	13.8	7	9	10	10
176-1341	4	M7x1	4.8	16.5	14.4	7	9	10	10
176-1342	4	1/8	5.4	16.5	15	7	13	10	10
176-1343	4	1/4	7.1	16.5	16.6	9	16	10	10
176-1344	6	M5	3.6	20.5	14.7	9	9	12	10
176-1345	6	1/8	5.4	20.5	15.8	9	13	12	10
176-1347	6	1/4	7.1	20.5	17.5	9	16	12	10
176-1348	6	3/8	8.1	20.5	19	9	20	12	10
176-1349	8	1/8	5.4	22	19.4	10	13	14	10
176-1350	8	1/4	7.1	22	18.7	10	16	14	10
176-1351	8	3/8	8.1	22	20.1	10	20	14	10
176-1812	10	1/4	7.1	26.5	22.8	13	16	17	10
176-1813	10	3/8	8.1	26.5	22.3	13	20	17	10
176-1814	10	1/2	9.6	26.5	23.8	13	25	17	10
176-1815	12	1/4	7.1	30	24.1	16	16	20	10
176-1816	12	3/8	8.1	30	23.6	16	20	20	10
176-1817	14	3/8	8.1	31	28.1	18	20	21	10
176-1818	14	1/2	9.6	31	26.1	18	25	21	10

ELBOW CONNECTOR
RACCORDO A L INTERMEDIO

WINKELVERSCHRAUBUNG
 RACCORD EQUERRE
 RACOR A L INTERMEDIO
 CONEXÃO EM "L" TUBO-TUBO

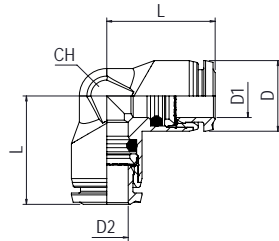

Code	D1	D2	L	D	CH	Pack.
176-1352	4	4	16.5	10	9	10
176-1353	6	6	20.5	12	11	10
176-1354	8	8	22	14	13	10
176-1819	10	10	26.5	17	16	10
176-1820	12	12	30	20	19	10

ORIENTING ELBOW
RACCORDO A L CON CODA LISCIA CURTA

WINKELSTECKERVERSCHRAUBUNG KURZ
 RACCORD EQUERRE ENCLIQUETABLE
 RACOR A L ORIENTABLE CON ESPIGA LISA CURTA
 CONEXÃO EM "L" COM PONTA LISA E CURTA

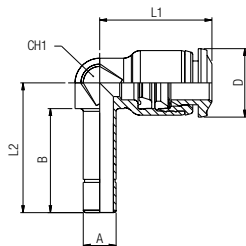

Code	Tube	A	B	L1	L2	CH1	D	Pack.
176-1355	4	4	17	16.5	20.8	7	10	10
176-1356	6	6	19	20.5	23.7	9	12.5	10
176-1357	8	8	20	22	26	10	14	10
176-1821	10	10	22.5	26.5	30	13	17	10

ORIENTING TEE MALE ADAPTOR "UNIVERSAL SHORT" - CENTRE LEG

RACCORDO A T ORIENTABILE MASCHIO "UNIVERSAL SHORT"

T-EINSCHRAUBVERSCHRAUBUNG KONISCH (DREHBAR) "UNIVERSAL SHORT"
TÉ ORIENTABLE À PIQUAGE MÂLE CENTRAL, CONIQUE "UNIVERSAL SHORT"
RACOR A T ORIENTABLE MACHO CENTRAL CÓNICO "UNIVERSAL SHORT"
CONEXÃO EM "T" CENTRAL ORIENTÁVEL COM ROSCA MACHO "UNIVERSAL SHORT"

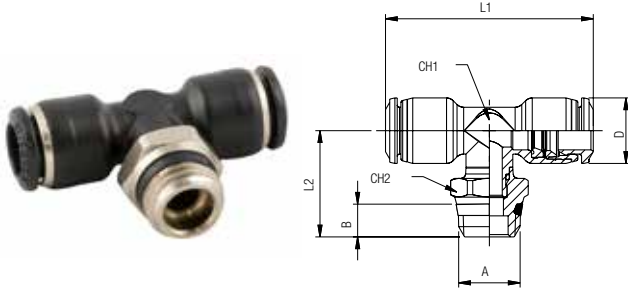

Code	Tube	A	B	L1	L2	CH1	CH2	D	Pack.
176-1358	6	1/8	5.5	41	20	9	13	12.5	10
176-1359	6	1/4	7	41	21.5	9	15	12.5	10
176-1360	8	1/8	5.5	44	21	10	13	14	10
176-1361	8	1/4	7	44	22.5	10	15	14	10
176-1362	8	3/8	7.5	44	23	10	17	14	10
176-1822	10	1/4	7	53	25.5	13	16	17	10
176-1823	10	3/8	7.5	53	25.5	13	17	17	10

ORIENTING TEE MALE ADAPTOR (PARALLEL) - CENTRE LEG

RACCORDO A T ORIENTABILE MASCHIO CILINDRICO

T-EINSCHRAUBVERSCHRAUBUNG ZYLINDRISCH (DREHBAR)
TÉ ORIENTABLE À PIQUAGE MÂLE CENTRAL, CYLINDRIQUE
RACOR A T ORIENTABLE MACHO CENTRAL CILÍNDRICO CON TÓRICA
CONEXÃO MACHO EM "T" ORIENTÁVEL COM ROSCA PARALELA

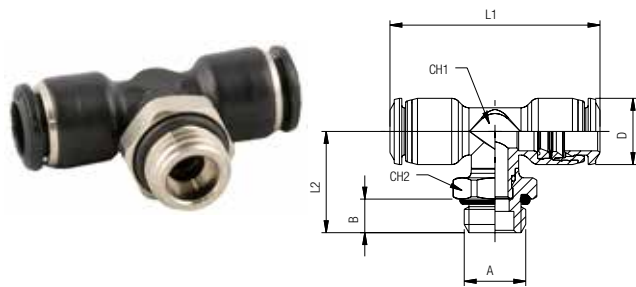

Code	Tube	A	B	L1	L2	CH1	CH2	D	Pack.
176-1363	4	M5	3.6	33	15.5	7	9	10	10
176-1364	4	1/8	5.4	33	17.1	7	13	10	10
176-1365	4	1/4	7.1	33	18.8	7	16	10	10
176-1366	6	M5	3.6	41	14.7	9	9	12.5	10
176-1367	6	1/8	5.4	41	18.4	9	13	12.5	10
176-1369	6	1/4	7.1	41	20	9	16	12.5	10
176-1370	8	1/8	5.4	44	22.1	10	13	14	10
176-1371	8	1/4	7.1	44	21.4	10	16	14	10
176-1824	10	1/4	7.1	53	26.7	13	16	17	10
176-1825	10	3/8	8.1	53	26.2	13	20	17	10

TEE CONNECTOR

RACCORDO A T INTERMEDIO

T-ANSCHLUSS
RACCORD TÉ
RACOR A T INTERMEDIO
CONEXÃO EM "T" TUBO-TUBO

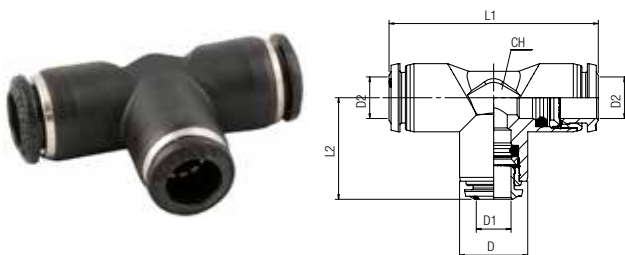

Code	Tube	L1	L2	CH	D	D1	D2	Pack.
176-1372	4	33	16.5	9	10	4	4	10
176-1373	6	41	20.5	11	12	6	6	10
176-1376	6-4-6	41	20	11	12.5	4	6	10
176-1375	8	44	22	13	14	8	8	10
176-1377	8-6-8	45	22.5	13	14	6	8	10
176-1826	10	53	26.5	16	17	10	10	10
176-1830	10-8-10	53	26	16	17	8	10	10
176-1827	12	61.5	30	19	20	12	12	10
176-1831	12-10-12	61.5	30	19	20	10	12	10
176-1828	14	61	30.5	20	21	14	14	10

Y CONNECTOR

RACCORDO A Y INTERMEDIO

Y-ANSCHLUSS
 RACCORD Y SIMPLE
 RACOR A Y INTERMEDIO
 CONEXÃO EM "Y" TUBO-TUBO

Code	D1	D2	A	L	CH	D	Pack.
176-1378	4	4	11	31.5	10	10	10
176-1379	6	6	13.5	37	12	12	10
176-1381	6	4	13,5	36,5	12	12,5	10
176-1380	8	8	15.5	40	14	14	10
176-1382	8	6	15,5	41	14	14	10
176-1832	10	10	19	48.5	17	18	10
176-1834	10	8	19	47,5	17	18	10
176-1833	12	12	22	57.5	20	20	10

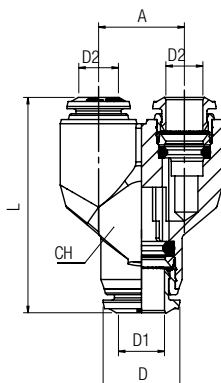

PLUG-IN Y CONNECTOR

RACCORDO A Y CON ADATTATORE

Y-STECKANSCHLUSS
 RACCORD Y ENCLIQUETABLE
 RACOR A Y INTERMEDIO CON ADAPTADOR
 CONEXÃO EM "Y" COM ADAPTADOR

Code	D1	D2	A	L	CH	D	B	Pack.
176-1383	4	4	11	43	10	10	15	10
176-1386	6	4	13,5	49,5	12	12,5	17	10
176-1384	6	6	13,5	50	12	12,5	17	10
176-1387	8	6	15,5	55	14	12,5	18	10
176-1385	8	8	15,5	55	14	14	18	10
176-1388	10	8	19	65	17	17	22	10
176-1835	10	10	19	65,5	17	17	22	10
176-1836	12	12	22	78	20	20	24,5	10

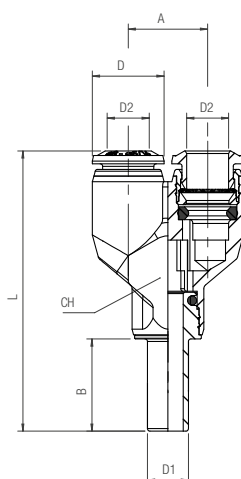

RACCORDO MULTIPLO DI RIDUZIONE

REDUCTION MANIFOLD

T-MEHRFACHVERTEILER REDUZIERT
 MULTI-TÉ RÉDUIT
 RACOR DISTRIBUIDOR MÚLTIPLE DE REDUCCIÓN
 CONEXÃO DE REDUÇÃO MÚLTIPLA

Code	Tube	A	B	L1	L2	C	D1	D2	E	Pack.
176-1837	6-4	13.5	6	74	22	13.5	14	12	3.3	10
176-1389	8-4	13.5	6	73	22	13.5	14	12	3.3	10
176-1838	8-6	13.5	6	73	22.5	13.5	14	12.5	3.3	10
176-1839	10-6	15	7	83	24	15	17	14	3.3	10
176-1840	10-8	15	7	83	23	15	17	14	3.3	10

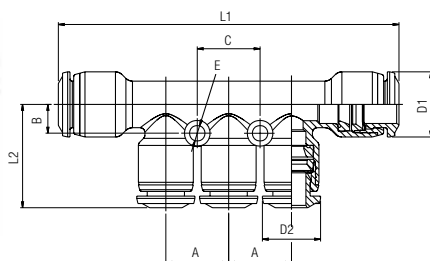

SINGLE BANJO BODY

ANELLO ORIENTABILE A L

RINGANSCHLUSS
CORPS SIMPLE POUR BANJO
ANILLO ORIENTABLE SIMPLE
ANEL ORIENTÁVEL EM "L"

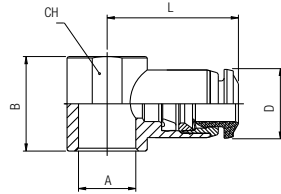

Code	Tube	A	B	L	CH	D	Pack.
176-1849	4	M5	14	19.5	9	10	10
176-1850	4	M6	14	19.5	9	10	10
176-1851	4	1/8	16.5	21.5	14	10	10
176-1852	5	M5	14	20.5	9	12	10
176-1853	5	M6	14	20.5	9	12	10
176-1854	5	1/8	16.5	22.5	14	12	10
176-1855	5	1/4	18.5	25	18	12	10
176-1856	6	M5	14	21	9	12	10
176-1857	6	M6	14	21	9	12	10
176-1858	6	1/8	16.5	23	14	12	10
176-1859	6	1/4	18.5	25.5	18	12	10
176-1860	8	1/8	16.5	23.5	14	14	10
176-1861	8	1/4	18.5	26	18	14	10
176-1862	8	3/8	22	27.5	21	14	10
176-1863	10	3/8	22	30.5	21	17	10
176-1864	12	3/8	22	32.5	21	20	10
176-1865	12	1/2	26	35	26	20	10

BANJO STEM SINGLE

VITE CAVA SINGOLA

EINFACHE HOHLSCHRAUBE
VIS POUR BANJO SIMPLE
TORNILLO SIMPLE
HASTE PARA CONEXÃO BANJO COM 1 CAVIDADE

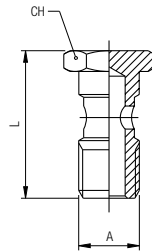

Code	A	L	CH	Pack.
176-1846	M5	22	8	10
176-1847	M6	23	8	10
176-1842	1/8	28	14	10
176-1843	1/4	32	17	10
176-1844	3/8	36	19	10
176-1845	1/2	42	24	10
176-1848	*M12x1.5	32	17	10

* Con questa vite utilizzare gli anelli orientabili da 1/4.
* With this banjo stem using 1/4 orienting banjo body.
* Bei dieser größe können dichtungringe für 1/4 eingesetzt werden.
* Compatible avec joint 1/4.
* Con este tornillo utilizar el anillo orientable de 1/4.
* Com esta haste para banjo utilizar os anéis orientáveis de 1/4.

ESEMPLI DI ASSEMBLAGGIO DELLE VITI CON ANELLI ORIENTABILI SINGOLI E DOPPI.

ASSEMBLING EXAMPLES OF VARIOUS BANJO STEMS WITH SINGLE AND DOUBLE BANJO BODIES.
MONTAGEBEISPIELE VON HOHLSCHRAUBEN MONTIERT MIT EINFACHEN- UND DOPPELTEN RINGANSCHLÜSSEN.
EXEMPLES D'ASSEMBLAGES DES CORPS SIMPLES ET DOUBLES.
EJEMPLO DE MONTAJE DEL TORNILLO CON EL ANILLO ORIENTABLE SIMPLE Y DOBLE.
EXEMPLOS DE MONTAGEM DOS BANJOS COM ANÉIS ORIENTÁVEIS SIMPLES E DUPLOS.



Vite cava singola
Banjo stem single
Einfache hohlschraube
Vis pour banjo simple
Tornillo simple
Haste p/ banjo c/ 1 cavidade

Vite cava doppia
Banjo stem double
Doppelte hohlschraube
Vis double pour banjo
Tornillo doble
Haste p/ banjo c/ 2 cavidades

Vite cava tripla
Banjo stem triple
Dreifache hohlschraube
Vis triple pour banjo
Tornillo triple
Haste p/banjo c/ 3 cavidades

MALE ADAPTOR PARALLEL

ADATTATORE MASCHIO CILINDRICO

EINSCHRAUBSTECKVERSCHRAUBUNG ZYLINDRISCH
 ADAPTATEUR ENCLIQUETABLE MÂLE, CYLINDRIQUE
 ADAPTADOR MACHO CILÍNDRICO CON TÓRICA
 ADAPTADOR MACHO COM ROSCA PARALELA

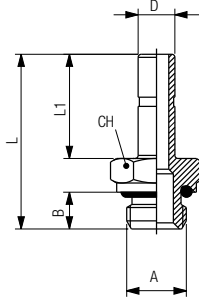

Code	D	A	B	L	L1	CH	Pack.
176-1299	4	M5	4	24	15	8	10
176-1300	4	1/8	6	26.5	15	13	10
176-1306	5	M5	4	26	17	8	10
176-1307	5	1/8	6	28.5	17	13	10
176-1308	5	1/4	8	31	17	16	10
176-1309	6	M5	4	26	17	8	10
176-1301	6	1/8	6	28.5	17	13	10
176-1303	8	1/8	6	29.5	18	13	10
176-1304	8	1/4	8	32	18	16	10
176-1305	8	3/8	9	33.5	18	20	10
176-1783	10	1/8	6	33.5	22	13	10
176-1779	10	1/4	8	36	22	16	10
176-1780	10	3/8	9	37.5	22	20	10
176-1781	12	1/4	8	38.5	24.5	16	10
176-1782	12	3/8	9	40	24.5	20	10
176-1784	14	1/2	10	44	26.5	24	10

POLYAMIDE PLUG

TAPPO IN POLIAMIDE

VERSCHLUSSZAPFEN POLYAMID
 BOUCHON EN POLYAMIDE
 TAPÓN EN POLIAMIDA
 TAMPÃO EM POLIAMIDA

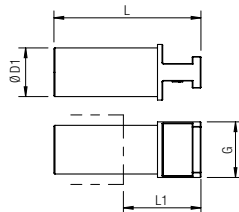

Code	ØD1	G	L	L1	Pack.
176-1310	4	6	29.5	15.5	10
176-1311	6	8	32	15.5	10
176-1312	8	10	35.5	19.5	10
176-1785	10	12	40	19.5	10
176-1786	12	14	41.5	20	10
176-1787	14	16	42	19.5	10

DOUBLE JOINT

GIUNZIONE DOPPIA

DOPPELSTECKER
 JONCTION DOUBLE (TECHNOPOLYMÈRE)
 UNIÓN DOBLE
 JUNÇÃO DUPLA

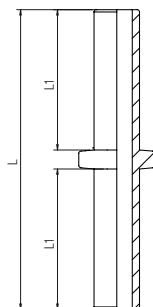

Code	Tube	L	L1	Pack.
176-1390	4	34,5	16	10
176-1391	6	39,5	18,5	10
176-1392	8	42	19,5	10
176-1866	10	51,5	24	10
176-1867	12	60	28	10

REDUCER

RIDUZIONE

REDUZIERUNG
 RÉDUCTION ENCLIQUETABLE (TECHNOPOLYMÈRE)
 REDUCCION
 REDUÇÃO

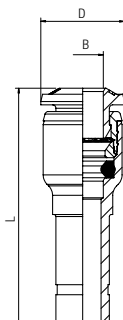

Code	A	B	L	D	Pack.
176-1393	6	4	34	10	10
176-1395	8	4	38.5	12	10
176-1394	8	6	39	12.5	10
176-1871	10	6	49.5	14	10
176-1868	10	8	42	14	10
176-1873	12	6	38.5	12.5	10
176-1869	12	8	41.5	14	10
176-1870	12	10	48.5	17	10
176-1874	14	8	37.5	14	10
176-1875	14	10	49.5	20	10
176-1872	14	12	50	20	10

CANOTTO MONTAGGIO CARTUCCE A COMPRESSIONE

AISTRUZIONI DI MONTAGGIO CARTUCCE A COMPRESSIONE ART. 55800N

PUSH-FIT CARTRIDGES ASSEMBLING INSTRUCTIONS ART. 55800N

ANLEITUNG FÜR DIE MONTAGE DER EINPRESSPATRONEN ART. 55800N

INSTRUCTION DE MONTAGE POUR CARTOUCHE RÉF. 55800N

INSTRUCCIONES DE MONTAJE CARTUCHO A COMPRESIÓN ART. 55800N

INSTRUÇÕES DE MONTAGEM DO CARTUCHO DE COMPRESSÃO CÓD. 55800N

1

Realizzare la sede per la cartuccia utilizzando l'apposita fresa Art. 55801.

Make the seat for the cartridge utilizing the suitable tool Art. 55801.

Machen sie die Sitze für die Einpresspatronen mit dem entsprechenden Stufenbohrer Art. 55801.

Usiner le logement de la cartouche à l'aide de l'outil de perçage réf. 55801.

Realizar la sede para el cartucho utilizando la correspondiente fresa Art. 55801.

Realize a furação da sede para o cartucho utilizando a fresa de cód. 55801.



2

Inserire la guarnizione a labbro nell'apposita sede.

Insert the lip seal inside of the seat.

Legen sie die Lippen-dichtung in die Bohrung ein.

Insérer le joint à lèvres dans le logement.

Insertar la junta de labio en la correspondiente sede.

Insira vedação no fundo da sede.

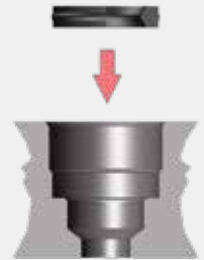

3

Inserire la cartuccia nel canotto di montaggio Art. 55802.

Insert the cartridge into the assembling tool Art. 55802.

Legen sie die Einpresspatrone in das Montage-werkzeug Art. 55802.

Insérer la cartouche dans l'outil de montage réf. 55802.

Insertar el cartucho en el útil de montaje Art. 55802.

Insira o cartucho no tubete de montagem Cód. 55802.



4

Premere la cartuccia all'interno della sede fino ad arrivare in battuta sul piano con il canotto.

Press the cartridge inside of the seat until it will be reached the abutment surface with the assembling tool.

Drücken sie die Einpresspatrone in die Bohrung, bis das Montagewerkzeug am Werkstück ansteht.

Presser la cartouche dans le logement jusqu'à ce que l'outil de montage soit en contact avec la surface.

Empujar el cartucho al interior de la sede hasta llegar al plano con el útil de montaje.

Pressione o cartucho no interior da sede até tocar a superfície de montagem com o tubete.



STRAIGHT MALE ADAPTOR (PARALLEL)

RACCORDO DIRITTO MASCHIO CILINDRICO

GERADE EINSCHRAUBVERSCHRAUBUNG ZYLINDRISCH

RACCORD DROIT MÂLE, CYLINDRIQUE

RACOR RECTO MACHO CILÍNDRICO CON TÓRICA

CONEXÃO RETA COM ROSCA PARALELA

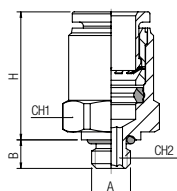

Code	Tube	A	B	H	CH1	CH2	Pack.
176-1397	3	M3	3	11	6	1.5	10
176-1398	3	M5	4	10	7	2	10
176-1399	4	M5	3.6	14	9	2.5	10
176-1400	4	1/8	5	11.5	13	3	10
176-1401	6	M5	3.6	16	11	2.5	10
176-1402	6	1/8	5	13.5	13	3	10
176-1404	6	1/4	7.1	12	16	4	10

STRAIGHT CONNECTOR

RACCORDO DIRITTO INTERMEDIO

VERBINDUNGSVERSCHRAUBUNG

RACCORD UNION DOUBLE

RACOR RECTO INTERMEDIO

CONEXÃO RETA TUBO-TUBO

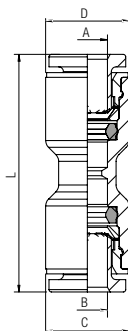

Code	A	B	C	D	L	Pack.
176-1405	4	4	8.5	8.5	25	10
176-1406	6	6	10.5	10.5	28	10
176-1407	8	6	10.5	14	34,5	10

BULKHEAD CONNECTOR

RACCORDO DIRITTO INTERMEDIO DI ATTRAVERSAMENTO

SCHOTTVERSCHRAUBUNG

RACCORD TRAVERSÉE DE CLOISON

RACOR RECTO INTERMEDIO PASATABIQUES

CONEXÃO PASSA-MURO RETA TUBO-TUBO

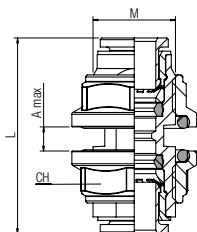

Code	Tube	M	L	CH	A max	Pack.
176-1408	4	M10x1	25	13	5,5	10
176-1409	6	M12x1	28	15	8,5	10

ORIENTING ELBOW MALE ADAPTOR (PARALLEL)
RACCORDO A L ORIENTABILE MASCHIO CILINDRICO

WINKELVERSCHRAUBUNG ZYLINDRISCH (DREHBAR)
 EQUERRE MÂLE ORIENTABLE, CYLINDRIQUE
 RACOR A L ORIENTABLE MACHO CILÍNDRICO
 CONEXÃO MACHO EM "L" ORIENTÁVEL COM ROSCA PARALELA

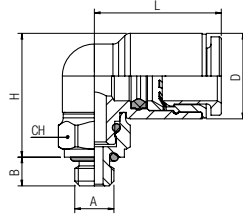

Code	Tube	A	B	H	L	D	CH	Pack.
176-1410	3	M3	3	13	11	6.5	8	10
176-1411	3	M5	4	12.5	11	6.5	8	10
176-1412	4	M5	3.6	13.5	14	8.5	8	10
176-1413	4	1/8	5	13	14	8.5	13	10
176-1414	4	1/4	7.1	13	14	8.5	16	10
176-1415	6	M5	3.6	15.5	16	10.5	8	10
176-1416	6	1/8	5	15	16	10.5	13	10
176-1417	6	1/4	7.1	15	16	10.5	16	10

EQUAL ELBOW

RACCORDO A L INTERMEDIO
 WINKELVERSCHRAUBUNG
 RACCORD EQUERRE
 RACOR A L INTERMEDIO
 CONEXÃO EM "L" TUBO-TUBO

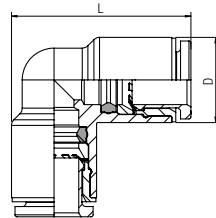

Code	Tube	L	D	Pack.
176-1418	4	19	8.5	10
176-1419	6	22.5	10.5	10

TEE CONNECTOR

RACCORDO A T INTERMEDIO
 T-ANSCHLUSS
 RACCORD TÉ
 RACOR A T INTERMEDIO
 CONEXÃO EM "T" TUBO-TUBO

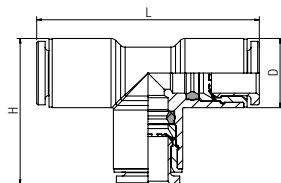

Code	Tube	H	L	D	Pack.
176-1420	3	14.5	22	6.5	10
176-1421	4	19	29	8.5	10
176-1422	6	22.5	34.5	10.5	10

ORIENTING FLOW REGULATOR FOR CYLINDER (PARALLEL)
REGOLATORE UNIDIREZIONALE ORIENTABILE PER CILINDRO FILETTO CILINDRICO

DURCHFLOSSREGLER ABLUFTDROSSELUNG (DREHBAR) MIT ZYL. GEWINDE
 RÉGLEUR A L'ÉCHAPPEMENT FILETAGE CYLINDRIQUE
 REGULADOR UNIDIRECCIONAL ORIENTABLE PARA CILINDRO ROSCA CILÍNDRICA
 REGULADORA PARA CILINDRO UNIDIRECCIONAL ORIENTÁVEL COM ROSCA PARALELA

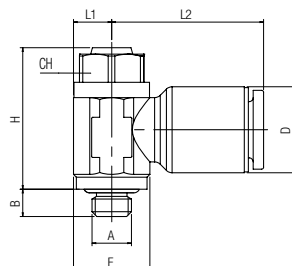

Code	Tube	A	B	H	E	L1	L2	D	CH	Pack.
176-1893	4	M5	3,6	18	9,5	4,5	16,5	8,5	8	10
176-1894	6	M5	3,6	18	9,5	4,5	19	10,5	8	10