

FEATURES

8 channels of LNA, VGA, antialiasing filter, ADC, and digital demodulator/decimator

Low power

**150 mW per channel, time gain compensation (TGC) mode,
40 MSPS**

**62.5 mW per channel, continuous wave (CW) mode;
<30 mW in power-down mode**

10 mm × 10 mm, 144-ball CSP_BGA

**TGC channel, input referred noise voltage: 0.82 nV/√Hz,
maximum gain**

Flexible power-down modes

Fast recovery from low power standby mode: <2 μs

Low noise preamplifier (LNA)

Input noise voltage: 0.78 nV/√Hz, gain = 21.6 dB

Programmable gain: 15.6 dB/17.9 dB/21.6 dB

**0.1 dB input compression point: 1.00 V p-p/0.75 V p-p/
0.45 V p-p**

Flexible active input impedance matching

Variable gain amplifier (VGA)

Attenuator range: 45 dB, linear-in-dB gain control

Postamplifier gain (PGA): 21 dB/24 dB/27 dB/30 dB

Antialiasing filter

**Programmable, second-order low-pass filter from 8 MHz to
18 MHz or 13.5 MHz to 30 MHz and high-pass filter**

Analog-to-digital converter (ADC)

Signal-to-noise ratio (SNR): 75 dB, 14 bits up to 125 MSPS

Configurable serial low voltage differential signaling (LVDS)

CW mode harmonic rejection I/Q demodulator

Individual programmable phase rotation

Dynamic range per channel: >160 dBFS/√Hz

Close in SNR: 156 dBc/√Hz, 1 kHz offset, -3 dBFS

Digital demodulator/decimator

**I/Q demodulator with programmable oscillator FIR
decimation filter**

APPLICATIONS

Medical imaging/ultrasound

Nondestructive testing (NDT)

GENERAL DESCRIPTION

The AD9670 is designed for low cost, low power, small size, and ease of use for medical ultrasound applications. It contains eight channels of a VGA with an LNA, a CW harmonic rejection I/Q demodulator with programmable phase rotation, an antialiasing filter, an ADC, and a digital demodulator and decimator for data processing and bandwidth reduction.

Each channel features a maximum gain of up to 52 dB, a fully differential signal path, and an active input preamplifier termination. The channel is optimized for high dynamic performance and low power in applications where a small package size is critical.

The LNA has a single-ended-to-differential gain that is selectable through the serial port interface (SPI). Assuming a 15 MHz noise bandwidth (NBW) and a 21.6 dB LNA gain, the LNA input SNR is 94 dB. In CW Doppler mode, each LNA output drives an I/Q demodulator that has independently programmable phase rotation with 16 phase settings.

Power-down of individual channels is supported to increase battery life for portable applications. Standby mode allows quick power-up for power cycling. In CW Doppler operation, the VGA, antialiasing filter, and ADC are powered down. The ADC contains several features designed to maximize flexibility and minimize system cost, such as a programmable clock, data alignment, and programmable digital test pattern generation. The digital test patterns include built-in fixed patterns, built-in pseudorandom patterns, and custom user-defined test patterns entered via the SPI.

AD9670* Product Page Quick Links

Last Content Update: 11/01/2016

[Comparable Parts](#)

View a parametric search of comparable parts

[Evaluation Kits](#)

- [AD9670 Evaluation Board](#)

[Documentation](#)

Data Sheet

- [AD9670: Octal Ultrasound AFE with Digital Demodulator Data Sheet](#)

[Reference Materials](#)

Press

- [Industry's First Octal Ultrasound Receiver with Digital I/Q Demodulator and Decimation Filter Reduces Processor Overhead in Ultrasound Systems](#)
- [Industry's First Octal Ultrasound Receiver with JESD204B Serial Interface Reduces Data I/O Routing and Simplifies Ultrasound System Design](#)
- [Low Cost, Octal Ultrasound Receiver with On-Chip RF Decimator and JESD204B Serial Interface](#)

[Design Resources](#)

- [AD9670 Material Declaration](#)
- [PCN-PDN Information](#)
- [Quality And Reliability](#)
- [Symbols and Footprints](#)

[Discussions](#)

View all AD9670 EngineerZone Discussions

[Sample and Buy](#)

Visit the product page to see pricing options

[Technical Support](#)

Submit a technical question or find your regional support number

* This page was dynamically generated by Analog Devices, Inc. and inserted into this data sheet. Note: Dynamic changes to the content on this page does not constitute a change to the revision number of the product data sheet. This content may be frequently modified.

TABLE OF CONTENTS

| | | | |
|--|----|---|----|
| Features | 1 | CW Doppler Operation..... | 33 |
| Applications..... | 1 | Digital Demodulator/Decimator..... | 35 |
| General Description | 1 | Vector Profile | 35 |
| Revision History | 2 | RF Decimator..... | 36 |
| Functional Block Diagram | 3 | Baseband Demodulator and Decimator..... | 37 |
| Specifications..... | 4 | Digital Test Waveforms..... | 38 |
| AC Specifications..... | 4 | Digital Block Power Saving Scheme | 38 |
| Digital Specifications | 7 | Serial Port Interface (SPI)..... | 39 |
| Switching Specifications | 8 | Hardware Interface..... | 39 |
| Timing Diagrams..... | 9 | Memory Map | 41 |
| Absolute Maximum Ratings..... | 11 | Reading the Memory Map Table..... | 41 |
| Thermal Impedance | 11 | Reserved Locations | 41 |
| ESD Caution..... | 11 | Default Values | 41 |
| Pin Configuration and Function Descriptions..... | 12 | Logic Levels..... | 41 |
| Typical Performance Characteristics | 15 | Recommended Startup Sequence | 41 |
| TGC Mode Characteristics | 15 | Memory Map Register Descriptions..... | 51 |
| CW Doppler Mode Characteristics | 19 | Outline Dimensions | 52 |
| Theory of Operation | 20 | Ordering Guide | 52 |
| TGC Operation..... | 20 | | |
| Analog Test Signal Generation | 33 | | |

REVISION HISTORY

2/16—Revision A: Initial Version

FUNCTIONAL BLOCK DIAGRAM

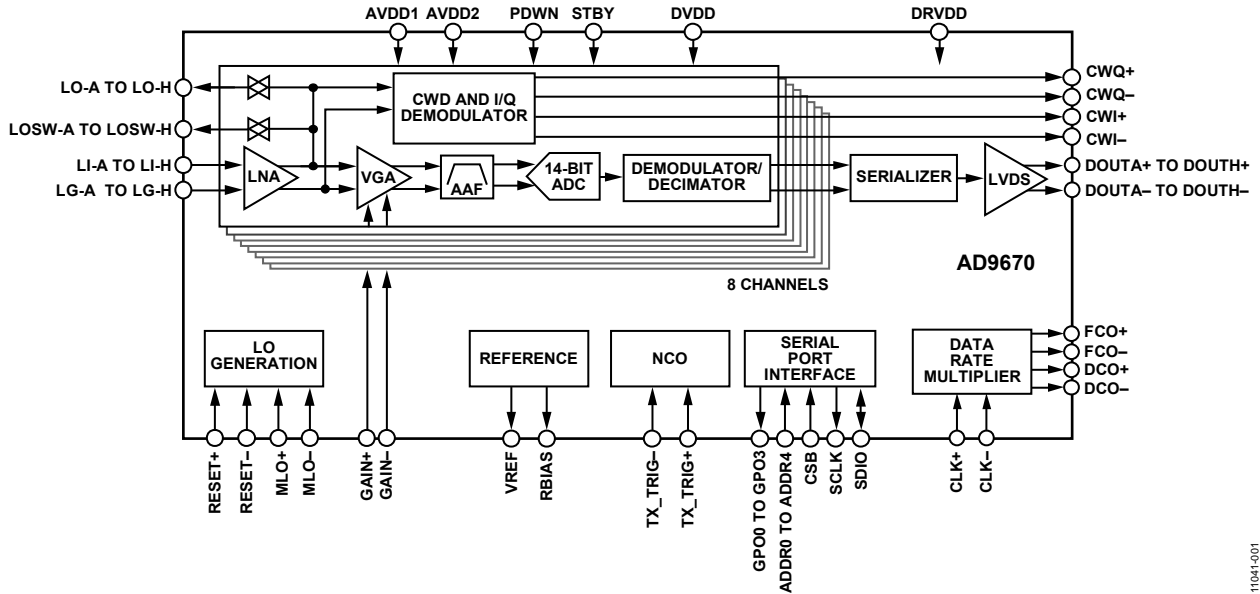

Figure 1.

11041-001

SPECIFICATIONS

AC SPECIFICATIONS

AVDD1 = 1.8 V, AVDD2 = 3.0 V, DVDD = 1.4 V, DRVDD = 1.8 V, 1.0 V internal ADC reference, full temperature range (0°C to 85°C), f_{IN} = 5 MHz, local oscillator (LO) band mode, $R_S = 50 \Omega$, $R_{FB} = \infty$ (unterminated), LNA gain = 21.6 dB, LNA bias = midhigh, PGA gain = 27 dB, analog gain control, VGAIN = (GAIN+) – (GAIN–) = 1.6 V, antialiasing filter, low-pass filter (LPF) cutoff = $f_{SAMPLE}/3$ in Mode I/Mode II, antialiasing filter LPF cutoff = $f_{SAMPLE}/4.5$ in Mode III/Mode IV, high-pass filter (HPF) cutoff = LPF cutoff/12.00, Mode I = $f_{SAMPLE} = 40$ MSPS, Mode II = $f_{SAMPLE} = 65$ MSPS, Mode III = $f_{SAMPLE} = 80$ MSPS, Mode IV = 125 MSPS, radio frequency (RF) decimator bypassed, digital demodulator and baseband decimator bypassed, digital high-pass filter bypassed, low power LVDS mode, unless otherwise noted. All gain setting options are listed, which can be configured via SPI registers, and all power supply currents and power dissipations are listed for the four mode settings (Mode I, Mode II, Mode III, and Mode IV), respectively, via slashes in Table 1.

Table 1.

| Parameter ¹ | Test Conditions/Comments | Min | Typ | Max | Unit |
|--|--|------|----------------|------|------------------------|
| LNA CHARACTERISTICS | | | | | |
| Gain | Single-ended input to differential output | | 15.6/17.9/21.6 | | dB |
| | Single-ended input to single-ended output | | 9.6/11.9/15.6 | | dB |
| 0.1 dB Input Compression Point | LNA gain = 15.6 dB | | 1.00 | | V p-p |
| | LNA gain = 17.9 dB | | 0.75 | | V p-p |
| | LNA gain = 21.6 dB | | 0.45 | | V p-p |
| 1 dB Input Compression Point | LNA gain = 15.6 dB | | 1.20 | | V p-p |
| | LNA gain = 17.9 dB | | 0.90 | | V p-p |
| | LNA gain = 21.6 dB | | 0.60 | | V p-p |
| Input Common Mode (LI-x, LG-x) | | | 2.2 | | V |
| Output Common Mode | | | | | |
| LO-x | Switch off | | High-Z | | Ω |
| | Switch on | | 1.5 | | V |
| LOSW-x | Switch off | | High-Z | | Ω |
| | Switch on | | 1.5 | | V |
| Input Resistance (LI-x) | $R_{FB} = 300 \Omega$ | | 50 | | Ω |
| | $R_{FB} = 1350 \Omega$ | | 200 | | Ω |
| | | | 6 | | k Ω |
| Input Capacitance (LI-x) | | | 20 | | pF |
| Input Noise Voltage | $R_S = 0 \Omega$ | | | | |
| | LNA gain = 15.6 dB | | 0.83 | | nV/ $\sqrt{\text{Hz}}$ |
| | LNA gain = 17.9 dB | | 0.82 | | nV/ $\sqrt{\text{Hz}}$ |
| | LNA gain = 21.6 dB | | 0.78 | | nV/ $\sqrt{\text{Hz}}$ |
| Input Noise Current | | | 2.6 | | pA/ $\sqrt{\text{Hz}}$ |
| FULL CHANNEL (TGC) CHARACTERISTICS | | | | | |
| Antialiasing Filter Low-Pass Cutoff | –3 dB, programmable, low band mode | 8 | | 18 | MHz |
| | –3 dB, programmable, high band mode | 13.5 | | 30 | MHz |
| In Range Antialiasing Filter Bandwidth Tolerance | | | ± 10 | | % |
| Group Delay Variation | $f = 1$ MHz to 18 MHz, $V_{GAIN} = -1.6$ V to +1.6 V | | ± 350 | | ps |
| Input Referred Noise Voltage | LNA gain = 15.6 dB | | 0.96 | | nV/ $\sqrt{\text{Hz}}$ |
| | LNA gain = 17.9 dB | | 0.90 | | nV/ $\sqrt{\text{Hz}}$ |
| | LNA gain = 21.6 dB | | 0.82 | | nV/ $\sqrt{\text{Hz}}$ |
| Noise Figure | $R_S = 50 \Omega$ | | | | |
| Active Termination Matched | LNA gain = 15.6 dB, $R_{FB} = 150 \Omega$ | | 5.6 | | dB |
| | LNA gain = 17.9 dB, $R_{FB} = 200 \Omega$ | | 4.8 | | dB |
| | LNA gain = 21.6 dB, $R_{FB} = 300 \Omega$ | | 3.8 | | dB |
| Unterminated | LNA gain = 15.6 dB | | 3.2 | | dB |
| | LNA gain = 17.9 dB | | 2.9 | | dB |
| | LNA gain = 21.6 dB | | 2.6 | | dB |
| Correlated Noise Ratio | No signal, correlated/uncorrelated | | –30 | | dB |
| Output Offset | | –100 | | +100 | LSB |

| Parameter ¹ | Test Conditions/Comments | Min | Typ | Max | Unit |
|--|--|------|-------------|-----------|--------------------------|
| Signal-to-Noise Ratio (SNR) | $f_{IN} = 5 \text{ MHz at } -12 \text{ dBFS, } V_{GAIN} = -1.6 \text{ V}$ | | 69 | | dBFS |
| | $f_{IN} = 5 \text{ MHz at } -1 \text{ dBFS}$ | | 59 | | dBFS |
| Close In SNR | $f_{IN} = 3.5 \text{ MHz at } -1 \text{ dBFS, } V_{GAIN} = 0 \text{ V, } 1 \text{ kHz offset}$ | | -130 | | dBc/ $\sqrt{\text{Hz}}$ |
| Second Harmonic | $f_{IN} = 5 \text{ MHz at } -12 \text{ dBFS, } V_{GAIN} = -1.6 \text{ V}$ | | -70 | | dBc |
| | $f_{IN} = 5 \text{ MHz at } -1 \text{ dBFS, } V_{GAIN} = 1.6 \text{ V}$ | | -62 | | dBc |
| Third Harmonic | $f_{IN} = 5 \text{ MHz at } -12 \text{ dBFS, } V_{GAIN} = -1.6 \text{ V}$ | | -61 | | dBc |
| | $f_{IN} = 5 \text{ MHz at } -1 \text{ dBFS, } V_{GAIN} = 1.6 \text{ V}$ | | -55 | | dBc |
| Two-Tone Intermodulation Distortion (IMD3) | $f_{RF1} = 5.015 \text{ MHz, } f_{RF2} = 5.020 \text{ MHz, } A_{RF1} = -1 \text{ dBFS, } A_{RF2} = -21 \text{ dBFS, } V_{GAIN} = 1.6 \text{ V, } \text{IMD3 relative to } A_{RF2}$ | | -54 | | dBc |
| Channel-to-Channel Crosstalk | $f_{IN1} = 5.0 \text{ MHz at } -1 \text{ dBFS}$ | | -60 | | dB |
| | Overrange condition ² | | -55 | | dB |
| GAIN ACCURACY | | | | | |
| | $T_A = 25^\circ\text{C}$ | | | | |
| Gain Law Conformance Error | $-1.6 < V_{GAIN} < -1.28 \text{ V}$ | | 0.4 | | dB |
| | $-1.28 \text{ V} < V_{GAIN} \leq +1.28 \text{ V}$ | -1.3 | | +1.3 | dB |
| | $1.28 \text{ V} < V_{GAIN} < 1.6 \text{ V}$ | | -0.5 | | dB |
| Linear Gain Error | $V_{GAIN} = 0 \text{ V, normalized for ideal antialiasing filter loss}$ | -1.3 | | +1.3 | dB |
| Channel-to-Channel Matching | $-1.28 \text{ V} < V_{GAIN} < +1.28 \text{ V, } 1 \sigma$ | | 0.1 | | dB |
| PGA Gain | | | 21/24/27/30 | | dB |
| GAIN CONTROL INTERFACE | | | | | |
| Control Range | Differential | -1.6 | | +1.6 | V |
| Control Common Mode | GAIN+, GAIN- | 0.7 | 0.8 | 0.9 | V |
| Input Impedance | GAIN+, GAIN- | | 10 | | M Ω |
| Gain Range | | | 45 | | dB |
| Scale Factor | Analog | | 14 | | dB/V |
| | Digital step size | | 3.5 | | dB |
| Response Time | Analog 45 dB change | | 750 | | ns |
| CW DOPPLER MODE | | | | | |
| LO Frequency | $f_{LO} = f_{MLO}/M$ | 1 | | 10 | MHz |
| Phase Resolution | Per channel, 4LO ³ mode | | 45 | | Degrees |
| | Per channel, 8LO mode, 16LO mode | | 22.5 | | Degrees |
| Output DC Bias (Single-Ended) | CWI+, CWI-, CWQ+, and CWQ- | | AVDD2/2 | | V |
| Output AC Current Range | Per CWI+, CWI-, CWQ+, and CWQ-, each channel enabled (2 f_{LO} and baseband signal) | | ± 2.2 | ± 2.5 | mA |
| Transconductance (Differential) | Demodulated I_{OUT}/V_{IN} , per CWI+, CWI-, CWQ+, and CWQ- | | | | |
| | LNA gain = 15.6 dB | | 3.3 | | mA/V |
| | LNA gain = 17.9 dB | | 4.3 | | mA/V |
| | LNA gain = 21.6 dB | | 6.6 | | mA/V |
| Input Referred Noise Voltage | $R_S = 0 \Omega, R_{FB} = \infty$ | | | | |
| | LNA gain = 15.6 dB | | 1.6 | | nV/ $\sqrt{\text{Hz}}$ |
| | LNA gain = 17.9 dB | | 1.3 | | nV/ $\sqrt{\text{Hz}}$ |
| | LNA gain = 21.6 dB | | 1.0 | | nV/ $\sqrt{\text{Hz}}$ |
| Noise Figure | $R_S = 50 \Omega, R_{FB} = \infty$ | | | | |
| | LNA gain = 15.6 dB | | 5.7 | | dB |
| | LNA gain = 17.9 dB | | 4.5 | | dB |
| | LNA gain = 21.6 dB | | 3.4 | | dB |
| Dynamic Range | $R_S = 0 \Omega, R_{FB} = \infty$ | | | | |
| | LNA gain = 15.6 dB | | 164 | | dBFS/ $\sqrt{\text{Hz}}$ |
| | LNA gain = 17.9 dB | | 162 | | dBFS/ $\sqrt{\text{Hz}}$ |
| | LNA gain = 21.6 dB | | 160 | | dBFS/ $\sqrt{\text{Hz}}$ |
| Close In SNR | -3 dBFS input, $f_{RF} = 2.5 \text{ MHz, } f_{LO} = 40 \text{ MHz, } 1 \text{ kHz offset, } 16\text{LO mode, } 1 \text{ channel enabled}$ | | 156 | | dBc/ $\sqrt{\text{Hz}}$ |
| | -3 dBFS input, $f_{RF} = 2.5 \text{ MHz, } f_{LO} = 40 \text{ MHz, } 1 \text{ kHz offset, } 16\text{LO mode, } 8 \text{ channels enabled}$ | | 161 | | dBc/ $\sqrt{\text{Hz}}$ |

| Parameter ¹ | Test Conditions/Comments | Min | Typ | Max | Unit |
|---|---|------|-------------------------|-------------------------|------------|
| Two-Tone Intermodulation Distortion (IMD3) | $f_{RF1} = 5.015$ MHz, $f_{RF2} = 5.020$ MHz, $f_{LO} = 80$ MHz, $A_{RF1} = -1$ dBFS, $A_{RF2} = -21$ dBFS, IMD3 relative to A_{RF2} | | -58 | | dB |
| LO Harmonic Rejection | 16LO, 8LO, and 4LO modes | | | -20 | dBc |
| Quadrature Phase Error | I to Q, all phases, 1 σ | | 0.15 | | Degrees |
| I/Q Amplitude Imbalance | I to Q, all phases, 1 σ | | 0.015 | | dB |
| Channel-to-Channel Matching | Phase I to I, Q to Q, 1 σ | | 0.5 | | Degrees |
| | Amplitude I to I, Q to Q, 1 σ | | 0.25 | | dB |
| POWER SUPPLY, MODE I/MODE II/ MODE III/MODE IV | | | | | |
| AVDD1 | | 1.7 | 1.8 | 1.9 | V |
| AVDD2 | | 2.85 | 3.0 | 3.6 | V |
| DVDD | Demodulator/decimator enabled | 1.3 | 1.4 | 1.9 | V |
| | Demodulator/decimator disabled | 1.3 | 1.8 | 1.9 | V |
| DRVDD | | 1.7 | 1.8 | 1.9 | V |
| I_{AVDD1} | TGC mode, LO band mode | | 148/187/ 223/291 | | mA |
| | CW Doppler mode | | 4 | | mA |
| I_{AVDD2} | TGC mode, no signal, low band mode | | 230 | | mA |
| | TGC mode, no signal, high band mode | | 239 | | mA |
| | CW Doppler mode, 8 channels enabled | | 140 | | mA |
| I_{DVDD} | RF decimator enabled in Mode III and Mode IV; demodulator/decimator enabled all modes | | 156/247/ 166/255 | | mA |
| I_{DRVDD} | ANSI-644 mode | | 133/184/ 141/146 | | mA |
| | Low power (IEEE 1596.3 similar) mode, 1 channel per lane mode | | 119/170/ 127/169 | | mA |
| Total Power Dissipation (Including Output Drivers) | TGC mode, no signal, RF decimator enabled in Mode III and Mode IV, demodulator/decimator disabled | | 1200/1400/ 1380/1630 | 1345/1555/ 1535/2100 | mW |
| | TGC mode, no signal, RF decimator enabled in Mode III and Mode IV, demodulator/decimator enabled | | 1400/1695/ 1570/1900 | 1560/1880/ 1740/2100 | mW |
| | CW Doppler mode, 8 channels enabled | | 500 | | mW |
| Power-Down Dissipation | | | | 30 | mW |
| Standby Power Dissipation | | | 630 | | mW |
| ADC RESOLUTION | | | 14 | | Bits |
| ADC REFERENCE | | | | | |
| Output Voltage Error | VREF = 1 V | | | ± 50 | mV |
| Load Regulation at 1.0 mA | VREF = 1 V | | 2 | | mV |
| Input Resistance | | | 7.5 | | k Ω |

¹ For a complete set of definitions and information about how these tests were completed, see the [AN-835 Application Note, Understanding High Speed ADC Testing and Evaluation](#).

² The overrange condition is specified as 6 dB more than the full-scale input range.

³ The internal LO frequency, f_{LO} , is generated from the supplied multiplier local oscillator frequency, f_{MLO} , by dividing it up by a configurable divider value (M) that can be 4, 8, or 16; the MLO signal is named 4LO, 8LO, or 16LO, accordingly.

DIGITAL SPECIFICATIONS

AVDD1 = 1.8 V, AVDD2 = 3.0 V, DVDD = 1.4 V, DRVDD = 1.8 V, 1.0 V internal ADC reference, full temperature range (0°C to 85°C), unless otherwise noted.

Table 2.

| Parameter ¹ | Temperature | Min | Typ | Max | Unit |
|---|-------------|-----------|------------------|-------------|-------|
| INPUTS | | | | | |
| CLK+, CLK–, TX_TRIG+, TX_TRIG– | | | CMOS/LVDS/LVPECL | | |
| Logic Compliance | | | | | |
| Differential Input Voltage ² | | 0.2 | | 3.6 | V p-p |
| Input Voltage Range | | GND – 0.2 | | AVDD1 + 0.2 | V |
| Input Common-Mode Voltage | | | 0.9 | | V |
| Input Resistance (Differential) | 25°C | | 15 | | kΩ |
| Input Capacitance | 25°C | | 4 | | pF |
| MLO+, MLO–, RESET+, RESET– | | | LVDS/LVPECL | | |
| Logic Compliance | | | | | |
| Differential Input Voltage ² | | 0.250 | | 2 × AVDD2 | V p-p |
| Input Voltage Range | | GND – 0.2 | | AVDD2 + 0.2 | V |
| Input Common-Mode Voltage | | –0.3 | AVDD2/2 | +0.3 | V |
| Input Resistance (Single-Ended) | 25°C | | 20 | | kΩ |
| Input Capacitance | 25°C | | 1.5 | | pF |
| LOGIC INPUTS | | | | | |
| PDWN, STBY, SCLK, SDIO, ADDR _x | | | | | |
| Logic 1 Voltage | | 1.2 | | DRVDD + 0.3 | V |
| Logic 0 Voltage | | | | 0.3 | V |
| Input Resistance ³ | 25°C | | 30 (26 for SDIO) | | kΩ |
| Input Capacitance ³ | 25°C | | 2 (5 for SDIO) | | pF |
| CSB | | | | | |
| Logic 1 Voltage | | 1.2 | | DRVDD + 0.3 | V |
| Logic 0 Voltage | | | | 0.3 | V |
| Input Resistance | 25°C | | 26 | | kΩ |
| Input Capacitance | 25°C | | 2 | | pF |
| LOGIC OUTPUTS | | | | | |
| SDIO ⁴ | | | | | |
| Logic 1 Voltage (I _{OH} = 800 μA) | | | 1.79 | | V |
| Logic 0 Voltage (I _{OL} = 50 μA) | | | | 0.05 | V |
| GPO0/GPO1/GPO2/GPO3 | | | | | |
| Logic 0 Voltage (I _{OL} = 50 μA) | | | | 0.05 | V |
| DIGITAL OUTPUTS (DOUT_{x+}, DOUT_{x–}) | | | | | |
| ANSI-644 | | | | | |
| Logic Compliance | | | LVDS | | |
| Differential Output Voltage (V _{OD}) | | 247 | | 454 | mV |
| Output Offset Voltage (V _{OS}) | | 1.125 | | 1.375 | V |
| Output Coding (Default) | | | Offset binary | | |
| Low Power, Reduced Signal Option | | | | | |
| Logic Compliance | | | LVDS | | |
| Differential Output Voltage (V _{OD}) | | 150 | | 250 | mV |
| Output Offset Voltage (V _{OS}) | | 1.10 | | 1.30 | V |
| Output Coding (Default) | | | Offset binary | | |

¹ For a complete set of definitions and information about how these tests were completed, see the [AN-835 Application Note, Understanding High Speed ADC Testing and Evaluation](#).

² Specified for LVDS and LVPECL only.

³ The typical input resistance and input capacitance values deviate for SDIO; these deviations are noted in the Typ column.

⁴ Specified for 13 SDIO pins sharing the same connection.

SWITCHING SPECIFICATIONS

AVDD1 = 1.8 V, AVDD2 = 3.0 V, DVDD = 1.4 V, DRVDD = 1.8 V, full temperature range (0°C to 85°C), RF decimator bypassed, digital demodulator and baseband decimator bypassed, unless otherwise noted.

Table 3.

| Parameter ¹ | Temperature | Min | Typ | Max | Unit |
|--|-------------|---------------------------------|--|---------------------------------|--------------|
| CLOCK ² | | | | | |
| Clock Rate | | | | | |
| 40 MSPS (Mode I) | Full | 20.5 | | 40 | MHz |
| 65 MSPS (Mode II) | Full | 20.5 | | 65 | MHz |
| 80 MSPS (Mode III) ³ | Full | 20.5 | | 80 | MHz |
| 125 MSPS (Mode IV) ⁴ | Full | 20.5 | | 125 | MHz |
| Clock Pulse Width High (t _{EH}) | Full | | 3.75 | | ns |
| Clock Pulse Width Low (t _{EL}) | Full | | 3.75 | | ns |
| OUTPUT PARAMETERS ^{2, 5} | | | | | |
| Propagation Delay (t _{PD}) | Full | 10.8 – 1.5 × t _{DCO} | 10.8 | 10.8 + 1.5 × t _{DCO} | ns |
| Rise Time (t _r) (20% to 80%) | Full | | 300 | | ps |
| Fall Time (t _f) (20% to 80%) | Full | | 300 | | ps |
| DCO Period (t _{DCO}) ⁶ | Full | | t _{SAMPLE} /7 | | ns |
| FCO Propagation Delay (t _{FCO}) | Full | 10.8 – 1.5 × t _{DCO} | 10.8 | 10.8 + 1.5 × t _{DCO} | ns |
| DCO Propagation Delay (t _{CPD}) ⁷ | Full | | t _{FCO} + (t _{SAMPLE} /28) | | ns |
| DCO to Data Delay (t _{DATA}) ⁷ | Full | (t _{SAMPLE} /28) – 300 | (t _{SAMPLE} /28) | (t _{SAMPLE} /28) + 300 | ps |
| DCO to FCO Delay (t _{FRAME}) ⁷ | Full | (t _{SAMPLE} /28) – 300 | (t _{SAMPLE} /28) | (t _{SAMPLE} /28) + 300 | ps |
| Data-to-Data Skew (t _{DATA-MAX} – t _{DATA-MIN}) | Full | | ±225 | ±400 | ps |
| TX_TRIG to CLK Setup Time (t _{SETUP}) | 25°C | 1 | | | ns |
| TX_TRIG to CLK Hold Time (t _{HOLD}) | 25°C | 1 | | | ns |
| Wake-Up Time | | | | | |
| Standby | 25°C | | 2 | | µs |
| Power-Down | 25°C | | 375 | | µs |
| ADC Pipeline Latency | Full | | 16 | | Clock cycles |
| APERTURE | | | | | |
| Aperture Uncertainty (Jitter) | 25°C | | <1 | | ps rms |
| LO GENERATION | | | | | |
| MLO ⁸ Frequency | | | | | |
| 4LO Mode | Full | 4 | | 40 | MHz |
| 8LO Mode | Full | 8 | | 80 | MHz |
| 16LO Mode | Full | 16 | | 160 | MHz |
| RESET ⁹ to MLO Setup Time (t _{SETUP}) | Full | 1 | t _{MLO} ¹⁰ /2 | | ns |
| RESET to MLO Hold Time (t _{HOLD}) | Full | 1 | t _{MLO} ¹⁰ /2 | | ns |

¹ For a complete set of definitions and information about how these tests were completed, see the [AN-835 Application Note, Understanding High Speed ADC Testing and Evaluation](#).

² The clock can be adjusted via the SPI.

³ Mode III must have the RF decimator enabled because the maximum data rate of the baseband demodulator and decimator is 65 MSPS.

⁴ Mode IV must have the RF decimator enabled because the maximum data rate of the baseband demodulator and decimator is 65 MSPS.

⁵ Measurements were taken using a device soldered to FR-4 material.

⁶ In the typical value, t_{SAMPLE}/7, 7 is based on the number of bits (14) divided by 2 because the interface uses double data rate (DDR) sampling.

⁷ t_{SAMPLE}/28 is based on the number of bits divided by 2 because the delays are based on half duty cycles.

⁸ MLO refers to the differential signal created via the MLO– pin and the MLO+ pin. This notation is used throughout the data sheet.

⁹ RESET refers to the differential signal created via the RESET– pin and the RESET+ pin. This notation is used throughout the data sheet.

¹⁰ The period of the MLO clock signal is represented by t_{MLO}.

TIMING DIAGRAMS

ADC Timing Diagram

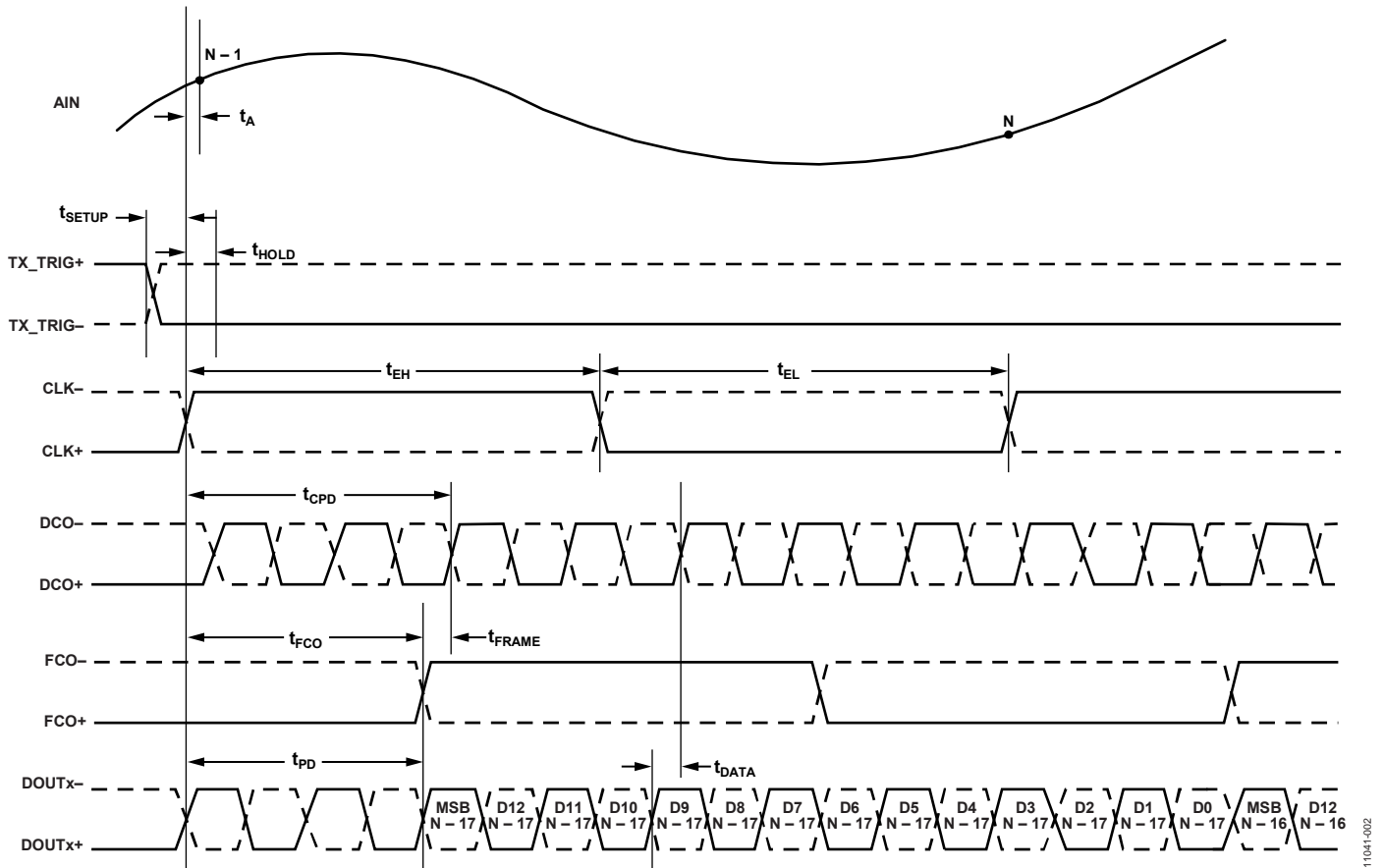

Figure 2. 14-Bit Data Serial Stream (Default, RF Decimator Bypassed, Demodulator Bypassed, Baseband Decimator Bypassed), 1 Channel/Lane Mode, FCO Mode = Word

CW Timing Diagrams

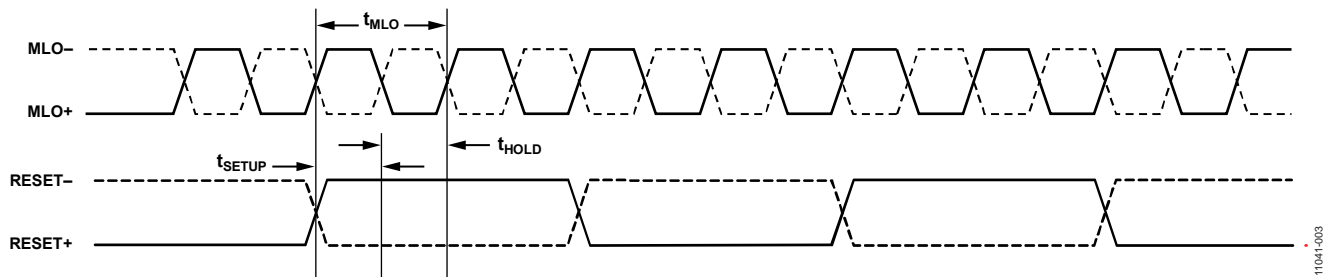

Figure 3. CW Doppler Mode Input MLO±, Continuous Synchronous RESET± Timing, Sampled on the Falling MLO± Edge, 4LO Mode

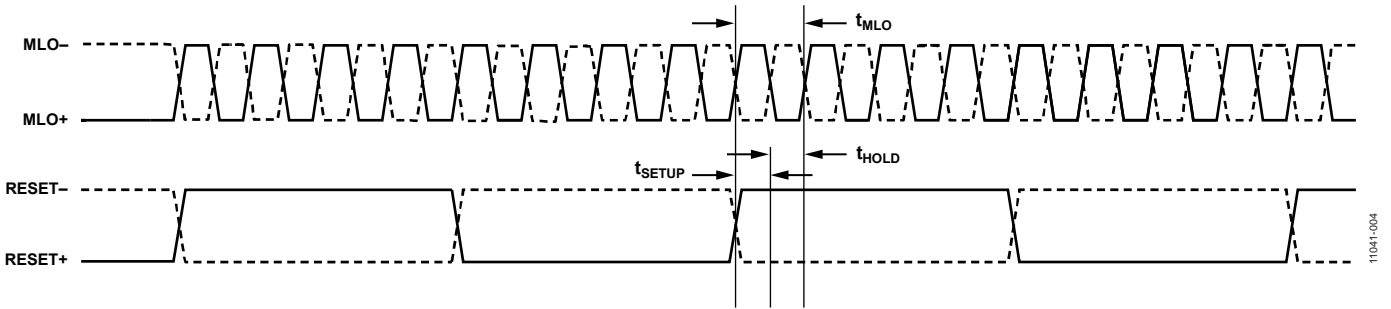

Figure 4. CW Doppler Mode Input MLO±, Continuous Synchronous RESET± Timing, Sampled on the Falling MLO± Edge, 8LO Mode

11041-004

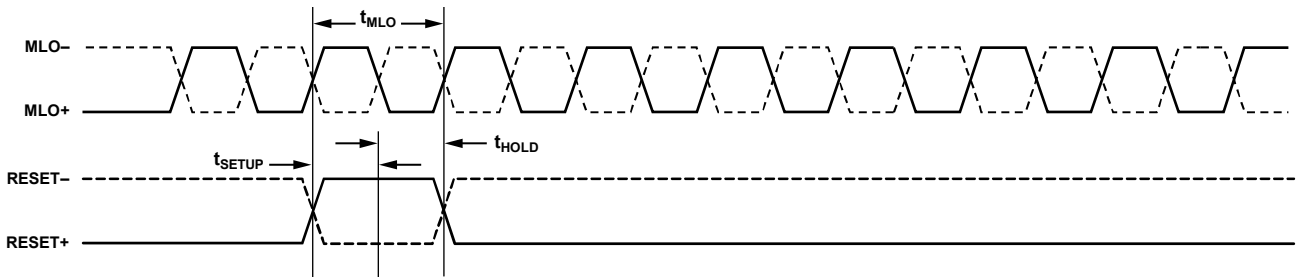

Figure 5. CW Doppler Mode Input MLO±, Pulse Synchronous RESET± Timing, 4LO/8LO/16LO Mode

11041-105

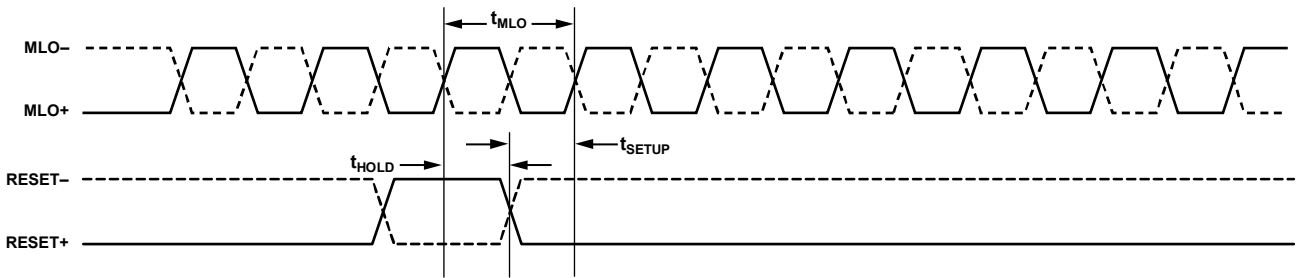

Figure 6. CW Doppler Mode Input MLO±, Pulse Asynchronous RESET± Timing, 4LO/8LO/16LO Mode

11041-106

ABSOLUTE MAXIMUM RATINGS

Table 4.

| Parameter | Rating |
|---|-------------------------|
| AVDD1 to GND | −0.3 V to +2.0 V |
| AVDD2 to GND | −0.3 V to +3.9 V |
| DVDD to GND | −0.3 V to +2.0 V |
| DRVDD to GND | −0.3 V to +2.0 V |
| GND to GND | −0.3 V to +0.3 V |
| AVDD2 to AVDD1 | −2.0 V to +3.9 V |
| AVDD1 to DRVDD | −2.0 V to +2.0 V |
| AVDD2 to DRVDD | −2.0 V to +3.9 V |
| Digital Outputs (DOUTx+, DOUTx−, DCO+, DCO−, FCO+, FCO−) to GND | −0.3 V to DRVDD + 0.3 V |
| LI-x, LG-x, LO-x, LOSW-x, CWI−, CWI+, CWQ−, CWQ+, GAIN+, GAIN−, RESET+, RESET−, MLO+, MLO−, GPO0, GPO1, GPO2, GPO3 to GND | −0.3 V to AVDD2 + 0.3 V |
| CLK+, CLK−, TX_TRIG+, TX_TRIG−, VREF to GND | −0.3 V to AVDD1 + 0.3 V |
| SDIO, PDWN, STBY, SCLK, CSB, ADDR _x | −0.3 V to DRVDD + 0.3 V |
| Operating Temperature Range (Ambient) | 0°C to 85°C |
| Storage Temperature Range (Ambient) | −65°C to +150°C |
| Maximum Junction Temperature | 150°C |
| Lead Temperature (Soldering, 10 sec) | 300°C |

Stresses at or above those listed under Absolute Maximum Ratings may cause permanent damage to the product. This is a stress rating only; functional operation of the product at these or any other conditions above those indicated in the operational section of this specification is not implied. Operation beyond the maximum operating conditions for extended periods may affect product reliability.

THERMAL IMPEDANCE

Table 5. Thermal Impedance

| Symbol | Description | Value ¹ | Unit |
|---------------|--|--------------------|------|
| θ_{JA} | Junction-to-ambient thermal resistance, 0.0 m/sec air flow per JEDEC JESD51-2 (still air) | 22.0 | °C/W |
| Ψ_{JB} | Junction-to-board thermal characterization parameter, 0 m/sec air flow per JEDEC JESD51-8 (still air) | 9.2 | °C/W |
| Ψ_{JT} | Junction-to-top-of-package characterization parameter, 0 m/sec air flow per JEDEC JESD51-2 (still air) | 0.12 | °C/W |

¹ Thermal impedance results are from simulations. The printed circuit board (PCB) is JEDEC multilayer. The thermal performance for actual applications requires careful inspection of the conditions in the application to determine if they are similar to those assumed in these calculations.

ESD CAUTION



ESD (electrostatic discharge) sensitive device. Charged devices and circuit boards can discharge without detection. Although this product features patented or proprietary protection circuitry, damage may occur on devices subjected to high energy ESD. Therefore, proper ESD precautions should be taken to avoid performance degradation or loss of functionality.

PIN CONFIGURATION AND FUNCTION DESCRIPTIONS

| | 1 | 2 | 3 | 4 | 5 | 6 | 7 | 8 | 9 | 10 | 11 | 12 |
|---|--------|----------|--------|--------|--------|-------|-------|--------|--------|--------|--------|--------|
| A | LI-E | LI-F | LI-G | LI-H | VREF | RBIAS | GAIN+ | GAIN- | LI-A | LI-B | LI-C | LI-D |
| B | LG-E | LG-F | LG-G | LG-H | GND | GND | CLNA | GND | LG-A | LG-B | LG-C | LG-D |
| C | LO-E | LO-F | LO-G | LO-H | GND | GND | GND | GND | LO-A | LO-B | LO-C | LO-D |
| D | LOSW-E | LOSW-F | LOSW-G | LOSW-H | GND | GND | GND | GND | LOSW-A | LOSW-B | LOSW-C | LOSW-D |
| E | GND | AVDD2 | AVDD2 | AVDD2 | GND | GND | GND | GND | AVDD2 | AVDD2 | AVDD2 | GND |
| F | AVDD1 | GND | AVDD1 | GND | AVDD1 | GND | GND | AVDD1 | GND | AVDD1 | GND | AVDD1 |
| G | GND | AVDD1 | GND | DVDD | GND | GND | GND | AVDD1 | GND | DVDD | GND | GND |
| H | CLK- | TX_TRIG- | GND | GND | GND | GND | ADDR4 | ADDR3 | ADDR2 | ADDR1 | ADDR0 | CSB |
| J | CLK+ | TX_TRIG+ | CWQ+ | GND | CWI+ | AVDD2 | MLO+ | RESET- | GPO3 | GPO1 | PDWN | SDIO |
| K | GND | GND | CWQ- | GND | CWI- | AVDD2 | MLO- | RESET+ | GPO2 | GPO0 | STBY | SCLK |
| L | DRVDD | DOUTH+ | DOUFG+ | DOUFG+ | DOUFG+ | DCO+ | FCO+ | DOUFG+ | DOUFG+ | DOUFG+ | DOUFG+ | DRVDD |
| M | GND | DOUTH- | DOUFG- | DOUFG- | DOUFG- | DCO- | FCO- | DOUFG- | DOUFG- | DOUFG- | DOUFG- | GND |

11041-005

Figure 7. Pin Configuration

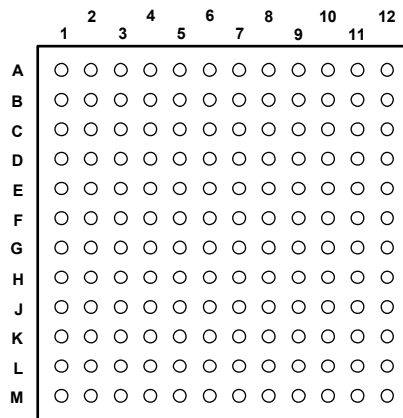

TOP VIEW
(Not to Scale)

Figure 8. CSP_BGA Pin Location

11041-006

Table 6. Pin Function Descriptions

| Pin No. | Mnemonic | Description |
|---|----------|--|
| B5, B6, B8, C5 to C8, D5 to D8, E1, E5 to E8, E12, F2, F4, F6, F7, F9, F11, G1, G3, G5 to G8, G10, G12, H3 to H6, J4, K1, K2, K4, M1, M12 | GND | Ground. Tie these pins to a quiet analog ground. |
| F1, F3, F5, F8, F10, F12, G2, G9, G4, G11 | AVDD1 | 1.8 V Analog Supply. |
| E2 to E4, E9 to E11, J6, K6 | DVDD | 1.4 V/1.8 V Digital Supply. |
| B7 | AVDD2 | 3.0 V Analog Supply. |
| L1, L12 | CLNA | LNA External Capacitor. |
| C1 | DRVDD | 1.8 V Digital Output Driver Supply. |
| D1 | LO-E | LNA Analog Inverted Output for Channel E. |
| A1 | LOSW-E | LNA Analog Switched Output for Channel E. |
| B1 | LI-E | LNA Analog Input for Channel E. |
| C2 | LG-E | LNA Ground for Channel E. |
| D2 | LO-F | LNA Analog Inverted Output for Channel F. |
| A2 | LOSW-F | LNA Analog Switched Output for Channel F. |
| B2 | LI-F | LNA Analog Input for Channel F. |
| C3 | LG-F | LNA Ground for Channel F. |
| D3 | LO-G | LNA Analog Inverted Output for Channel G. |
| A3 | LOSW-G | LNA Analog Switched Output for Channel G. |
| B3 | LI-G | LNA Analog Input for Channel G. |
| C4 | LG-G | LNA Ground for Channel G. |
| D4 | LO-H | LNA Analog Inverted Output for Channel H. |
| A4 | LOSW-H | LNA Analog Switched Output for Channel H. |
| B4 | LI-H | LNA Analog Input for Channel H. |
| H1 | LG-H | LNA Ground for Channel H. |
| J1 | CLK- | Clock Input Complement. |
| H2 | CLK+ | Clock Input True. |
| J2 | TX_TRIG- | Transmit Trigger Complement. |
| H11 | TX_TRIG+ | Transmit Trigger True. |
| H10 | ADDR0 | Chip Address Bit 0. |
| H9 | ADDR1 | Chip Address Bit 1. |
| H8 | ADDR2 | Chip Address Bit 2. |
| H7 | ADDR3 | Chip Address Bit 3. |
| M2 | ADDR4 | Chip Address Bit 4. |
| L2 | DOUTH- | ADC H Digital Output Complement. |
| M3 | DOUTH+ | ADC H Digital Output True. |
| L3 | DOUTG- | ADC G Digital Output Complement. |
| M4 | DOUTG+ | ADC G Digital Output True. |
| L4 | DOUTF- | ADC F Digital Output Complement. |
| M5 | DOUTF+ | ADC F Digital Output True. |
| L5 | DOUTE- | ADC E Digital Output Complement. |
| M6 | DOUTE+ | ADC E Digital Output True. |
| L6 | DCO- | Digital Clock Output Complement. |
| M7 | DCO+ | Digital Clock Output True. |
| L7 | FCO- | Frame Clock Digital Output Complement. |
| M8 | FCO+ | Frame Clock Digital Output True. |
| L8 | DOUTD- | ADC D Digital Output Complement. |
| M9 | DOUTD+ | ADC D Digital Output True. |
| L9 | DOUTC- | ADC C Digital Output Complement. |
| M10 | DOUTC+ | ADC C Digital Output True. |
| L10 | DOUTB- | ADC B Digital Output Complement. |
| | DOUTB+ | ADC B Digital Output True. |

| Pin No. | Mnemonic | Description |
|---------|----------|--|
| M11 | DOUTA- | ADC A Digital Output Complement. |
| L11 | DOUTA+ | ADC A Digital Output True. |
| K11 | STBY | Standby Power-Down. |
| J11 | PDWN | Full Power-Down. |
| K12 | SCLK | Serial Clock. |
| J12 | SDIO | Serial Data Input/Output. |
| H12 | CSB | Chip Select Bar. |
| B9 | LG-A | LNA Ground for Channel A. |
| A9 | LI-A | LNA Analog Input for Channel A. |
| D9 | LOSW-A | LNA Analog Switched Output for Channel A. |
| C9 | LO-A | LNA Analog Inverted Output for Channel A. |
| B10 | LG-B | LNA Ground for Channel B. |
| A10 | LI-B | LNA Analog Input for Channel B. |
| D10 | LOSW-B | LNA Analog Switched Output for Channel B. |
| C10 | LO-B | LNA Analog Inverted Output for Channel B. |
| B11 | LG-C | LNA Ground for Channel C. |
| A11 | LI-C | LNA Analog Input for Channel C. |
| D11 | LOSW-C | LNA Analog Switched Output for Channel C. |
| C11 | LO-C | LNA Analog Inverted Output for Channel C. |
| B12 | LG-D | LNA Ground for Channel D. |
| A12 | LI-D | LNA Analog Input for Channel D. |
| D12 | LOSW-D | LNA Analog Switched Output for Channel D. |
| C12 | LO-D | LNA Analog Inverted Output for Channel D. |
| K10 | GPO0 | General-Purpose Open Drain Output 0. |
| J10 | GPO1 | General-Purpose Open Drain Output 1. |
| K9 | GPO2 | General-Purpose Open Drain Output 2. |
| J9 | GPO3 | General-Purpose Open Drain Output 3. |
| J8 | RESET- | Synchronizing Input for LO Divide by M Counter Complement. |
| K8 | RESET+ | Synchronizing Input for LO Divide by M Counter True. |
| K7 | MLO- | CW Doppler Multiplier Local Oscillator (MLO) Input Complement. |
| J7 | MLO+ | CW Doppler MLO Input True. |
| A8 | GAIN- | Gain Control Voltage Input Complement. |
| A7 | GAIN+ | Gain Control Voltage Input True. |
| A6 | RBIAS | External Resistor to Set the Internal ADC Core Bias Current. |
| A5 | VREF | Voltage Reference Input/Output. |
| K5 | CWI- | CW Doppler I Output Complement. |
| J5 | CWI+ | CW Doppler I Output True. |
| K3 | CWQ- | CW Doppler Q Output Complement. |
| J3 | CWQ+ | CW Doppler Q Output True. |

TYPICAL PERFORMANCE CHARACTERISTICS

TGC MODE CHARACTERISTICS

Mode I = $f_{\text{SAMPLE}} = 40$ MSPS, $f_{\text{IN}} = 5$ MHz, LO band mode, $R_S = 50 \Omega$, $R_{\text{FB}} = \infty$ (unterminated), LNA gain = 21.6 dB, LNA bias = midhigh, PGA gain = 27 dB, $V_{\text{GAIN}} = (\text{GAIN}+) - (\text{GAIN}-) = 1.6$ V, antialiasing filter LPF cutoff = $f_{\text{SAMPLE}} / 3$, HPF cutoff = LPF cutoff/12.00 (default), RF decimator bypassed, digital demodulator and baseband decimator bypassed, unless otherwise noted.

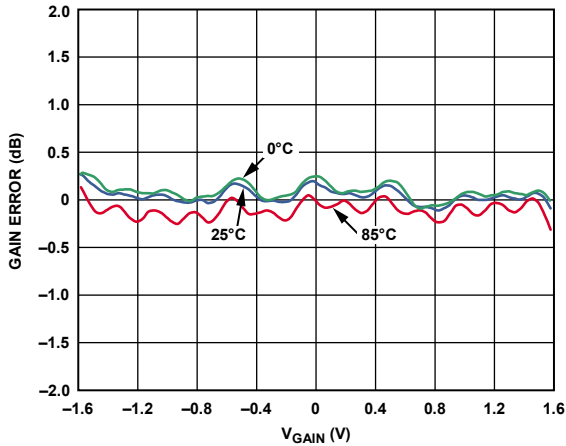

Figure 9. Gain Error vs. V_{GAIN}

11041-107

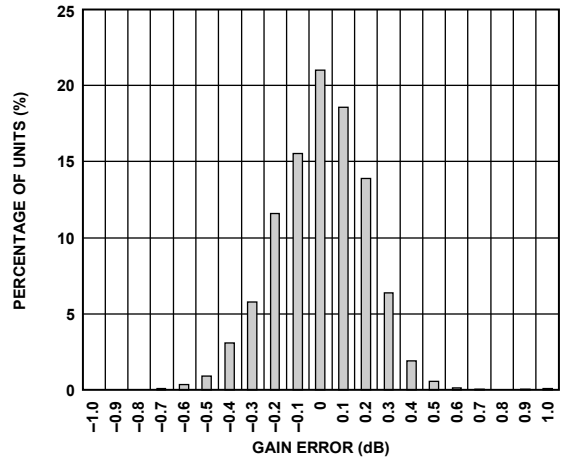

Figure 12. Gain Error Histogram, $V_{\text{GAIN}} = 1.28$ V

11041-110

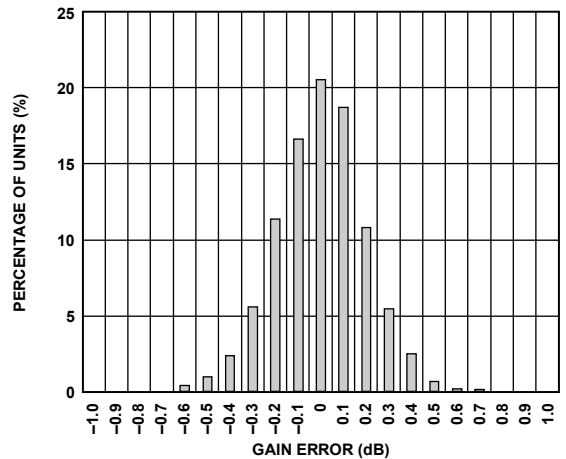

Figure 10. Gain Error Histogram, $V_{\text{GAIN}} = -1.28$ V

11041-108

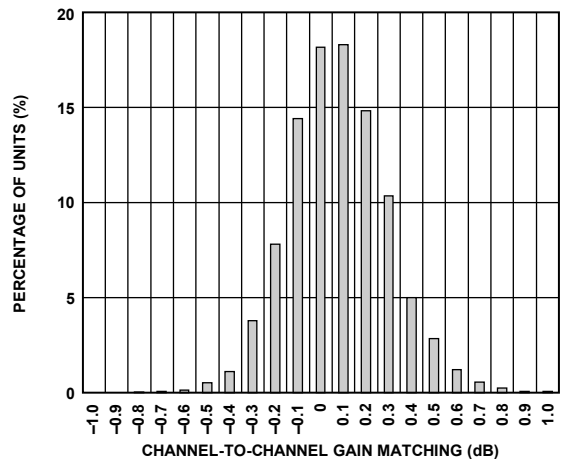

Figure 13. Gain Matching Histogram, $V_{\text{GAIN}} = -1.2$ V

11041-111

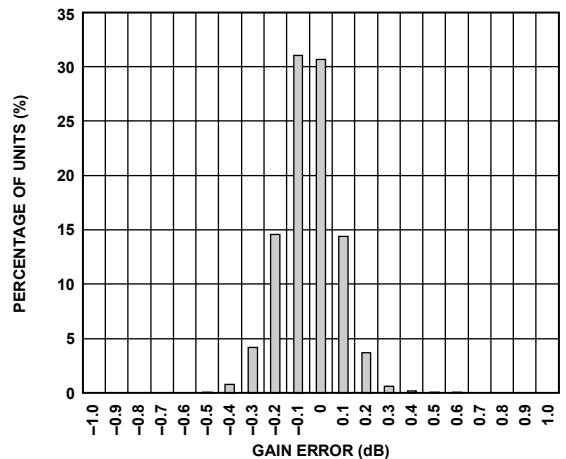

Figure 11. Gain Error Histogram, $V_{\text{GAIN}} = 0$ V

11041-109

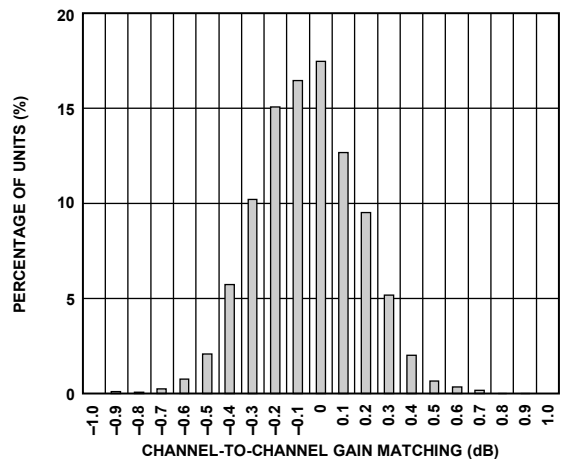

Figure 14. Gain Matching Histogram, $V_{\text{GAIN}} = 1.2$ V

11041-112

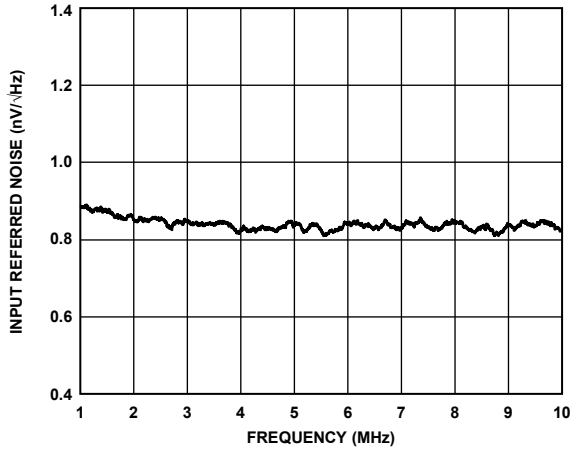

Figure 15. Short-Circuit, Input Referred Noise vs. Frequency

11041-008

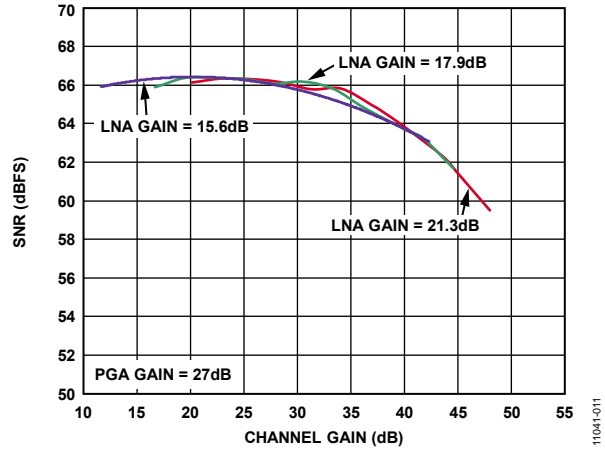

Figure 18. SNR vs. Channel Gain and LNA Gain, $A_{OUT} = -1.0$ dBFS

11041-011

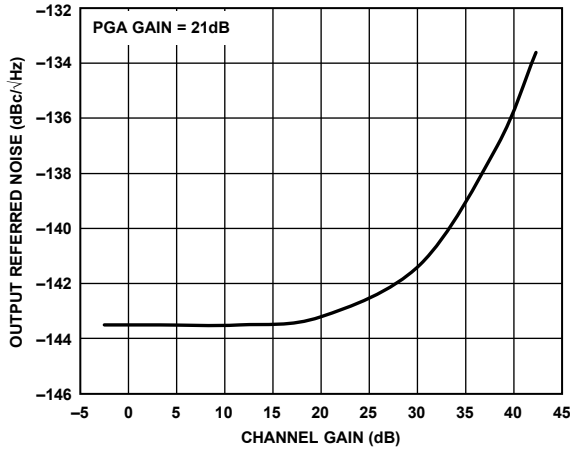

Figure 16. Short-Circuit, Output Referred Noise vs. Channel Gain, PGA Gain = 21 dB, $V_{GAIN} = 1.6$ V

11041-009

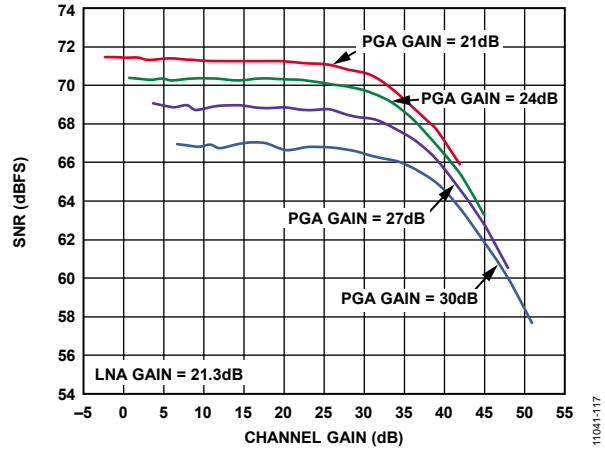

Figure 19. SNR vs. Channel Gain and PGA Gain, $A_{IN} = -45$ dBm

11041-117

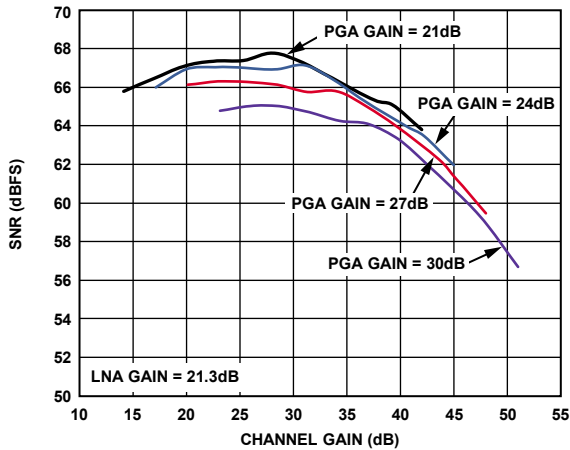

Figure 17. SNR vs. Channel Gain and PGA Gain, $A_{OUT} = -1.0$ dBFS

11041-010

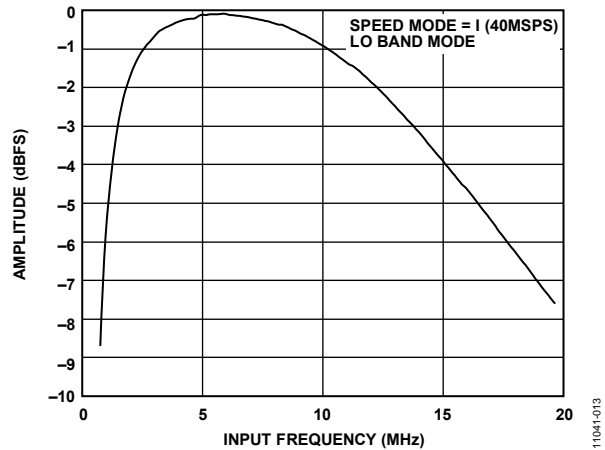

Figure 20. Antialiasing Filter Pass-Band Response, LPF Cutoff = $1/3 \times f_{SAMPLE}$, HPF = $1/12 \times$ LPF Cutoff

11041-013

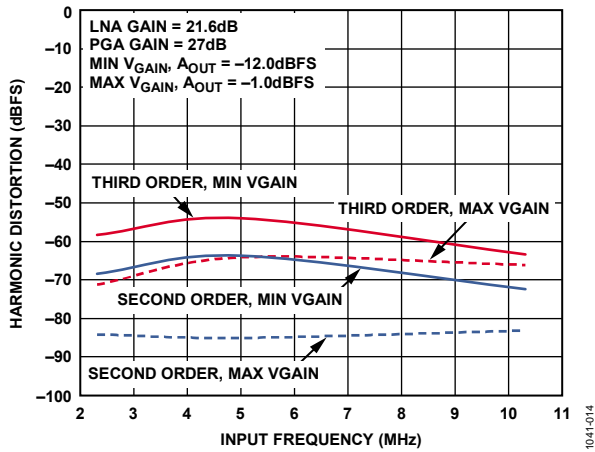

Figure 21. Second-Order and Third-Order Harmonic Distortion vs. Input Frequency, $A_{OUT} = -1.0$ dBFS

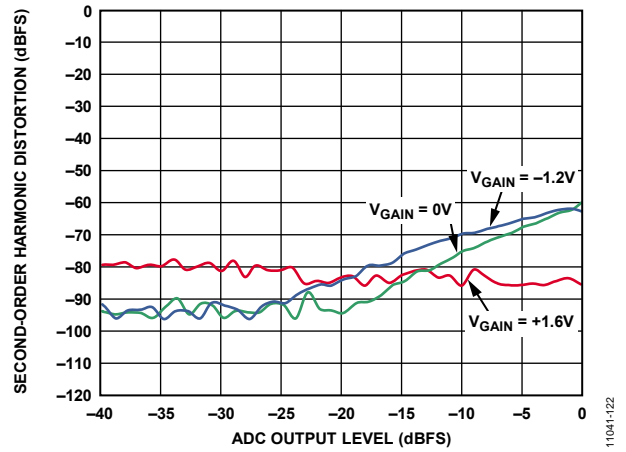

Figure 24. Second-Order Harmonic Distortion vs. ADC Output Level (A_{OUT})

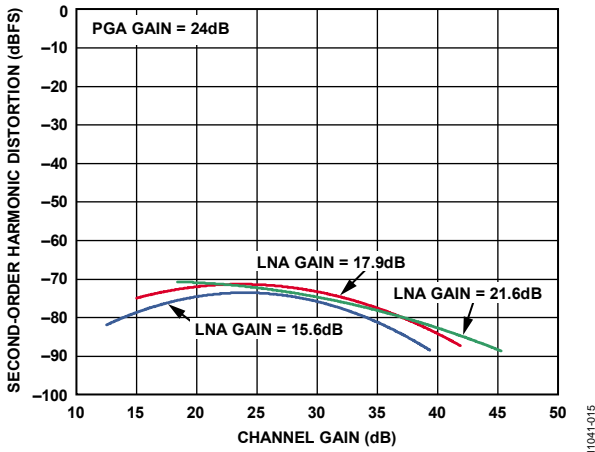

Figure 22. Second-Order Harmonic Distortion vs. Channel Gain, $A_{OUT} = -1.0$ dBFS

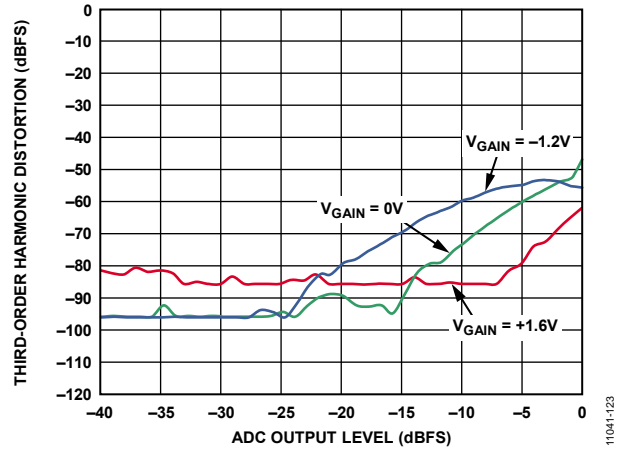

Figure 25. Third-Order Harmonic Distortion vs. ADC Output Level (A_{OUT})

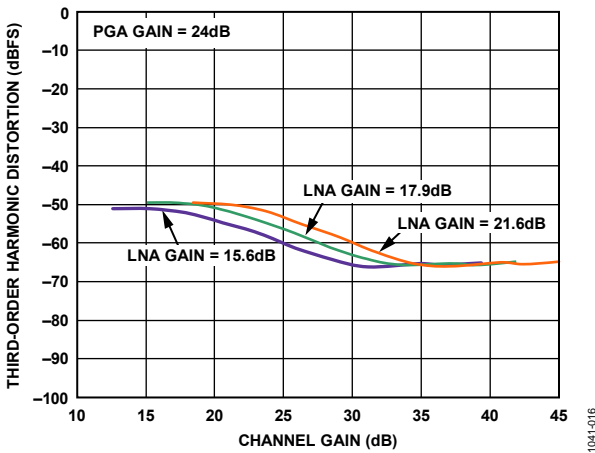

Figure 23. Third-Order Harmonic Distortion vs. Channel Gain, $A_{OUT} = -1.0$ dBFS

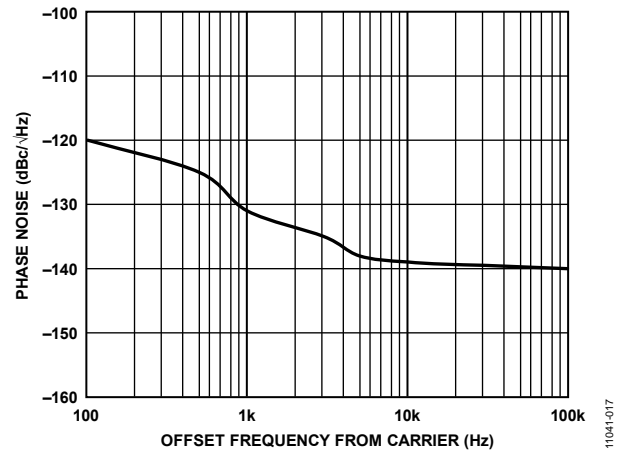

Figure 26. TGC Path Phase Noise, LNA Gain = 21.6 dB, PGA Gain = 27 dB, $V_{GAIN} = 0$ V

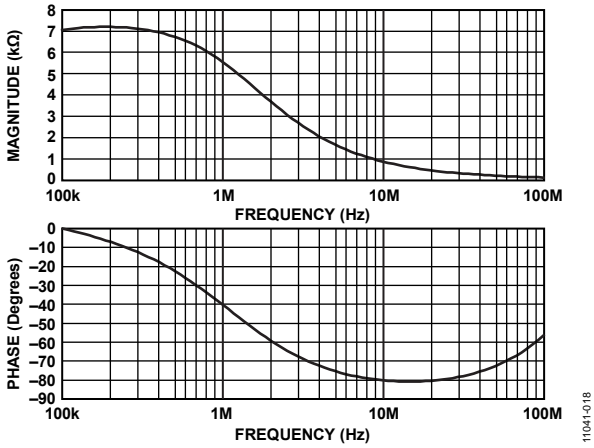

Figure 27. LNA Input Impedance Magnitude and Phase, Underterminated

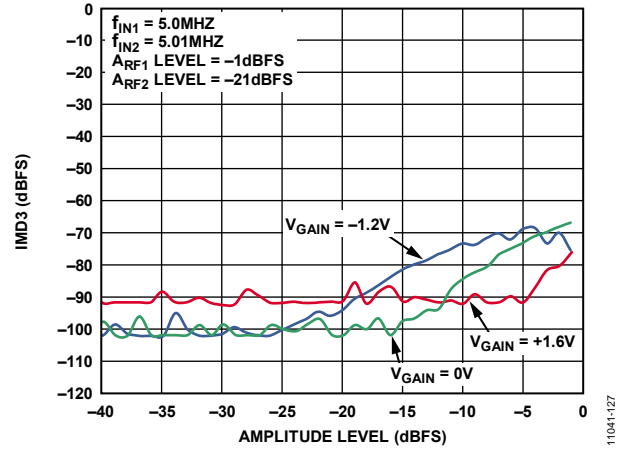

Figure 29. IMD3 vs. ADC Output Amplitude Level

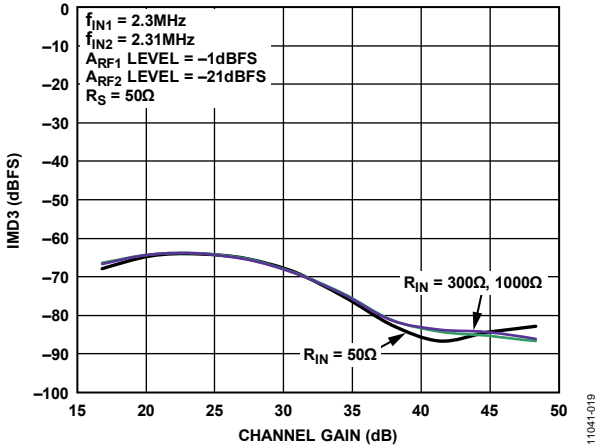

Figure 28. IMD3 vs. Channel Gain

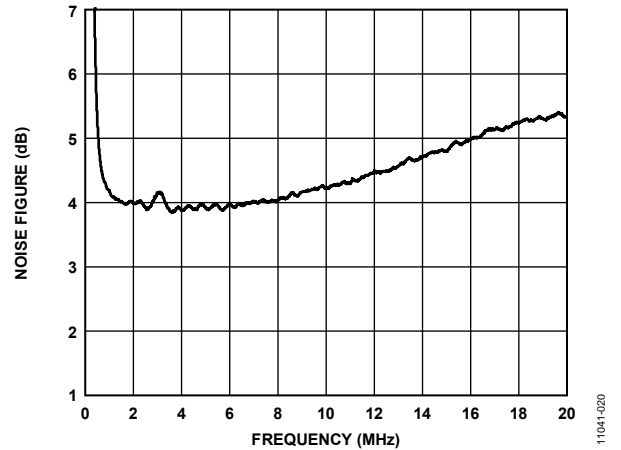

Figure 30. Noise Figure vs. Frequency, R_S = R_{IN} = 100Ω, LNA Gain = 17.9 dB, PGA Gain = 30 dB, V_{GAIN} = 1.6 V

CW DOPPLER MODE CHARACTERISTICS

$f_{IN} = 5$ MHz, $f_{LO} = 20$ MHz, 4LO mode, $R_s = 50 \Omega$, LNA gain = 21.6 dB, LNA bias = mid-high, all CW channels enabled, phase rotation = 0° .

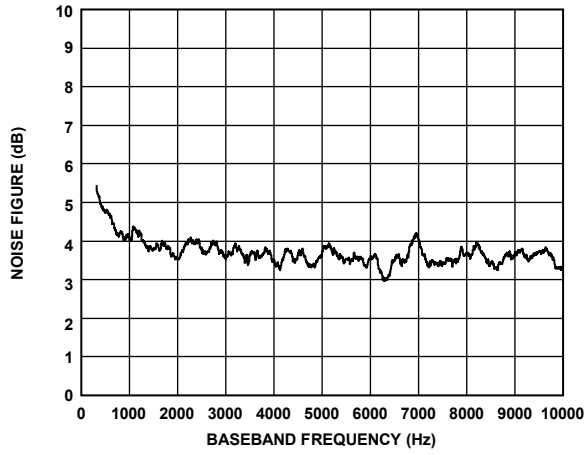

Figure 31. Noise Figure vs. Baseband Frequency

11041-021

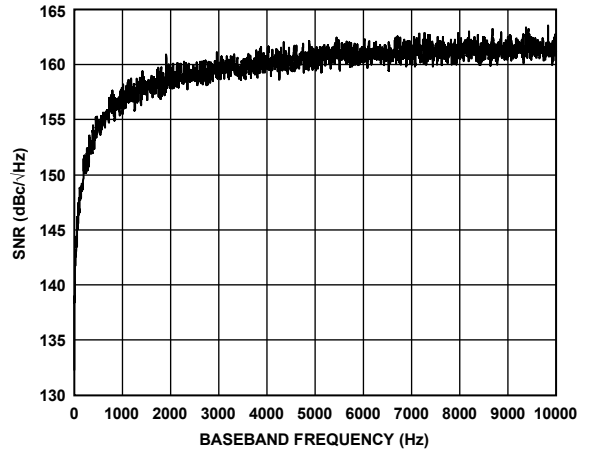

Figure 32. SNR vs. Baseband Frequency, -3 dBFS LNA Input

11041-022

THEORY OF OPERATION

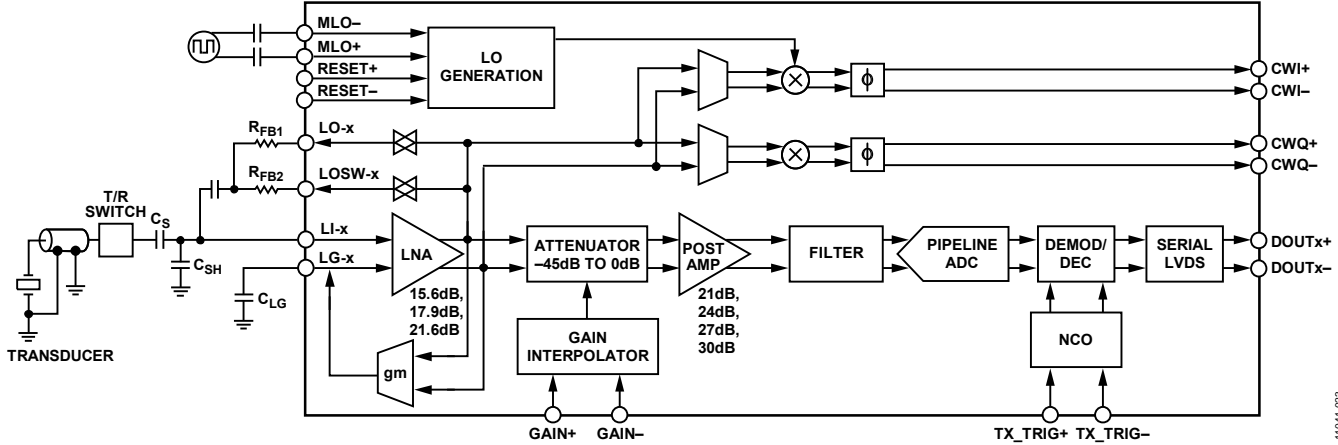

Figure 33. Simplified Block Diagram of a Single Channel

Each channel in the AD9670 contains both a TGC signal path and a CW Doppler signal path. Common to both signal paths, the LNA provides four user adjustable input impedance termination options for matching different probe impedances. The CW Doppler path includes an I/Q demodulator with programmable phase rotation needed for analog beamforming. The TGC path includes a differential X-AMP® VGA, an antialiasing filter, an ADC, and a digital demodulator and decimator. Figure 33 shows a simplified block diagram with external components.

TGC OPERATION

The system gain for TGC operation is distributed as shown in Table 7.

Table 7. Channel Analog Gain Distribution

| Section | Nominal Gain (dB) |
|------------|---------------------------------|
| LNA | 15.6/17.9/21.6 (LNA_{GAIN}) |
| Attenuator | -45 to 0 (VGA_{ATT}) |
| VGA | 21/24/27/30 (PGA_{GAIN}) |
| Filter | 0 |
| ADC | 0 |

Each LNA output is dc-coupled to a VGA input. The VGA consists of an attenuator with a range of -45 dB to 0 dB, followed by an amplifier with 21 dB/24 dB/27 dB/30 dB of gain. The X-AMP gain interpolation technique results in low gain error and uniform bandwidth, and differential signal paths minimize distortion.

The linear in dB gain (law conformance) range of the TGC path is 45 dB. The slope of the gain control interface is 14 dB/V, and the gain control range is -1.6 V to +1.6 V. Equation 1 is the expression for the differential voltage, V_{GAIN} , at the gain control interface. Equation 2 is the expression for the VGA attenuation, VGA_{ATT} , as a function of V_{GAIN} .

$$V_{GAIN} (V) = (GAIN+) - (GAIN-) \quad (1)$$

$$VGA_{ATT} (dB) = -14 \text{ dB/V} (1.6) - V_{GAIN} \quad (2)$$

Then, calculate the total channel gain using Equation 3.

$$\text{Channel Gain (dB)} = LNA_{GAIN} + VGA_{ATT} + PGA_{GAIN} \quad (3)$$

In its default condition, the LNA has a gain of 21.6 dB (12×), and the VGA postamplifier gain is 24 dB. If the voltage on the GAIN+ pin is 0 V and the voltage on the GAIN- pin is 1.6 V (45.1 dB attenuation), the total gain of the channel is 0.5 dB if the LNA input is unmatched. The channel gain is -5.5 dB if the LNA is matched to 50 Ω ($R_{FB} = 300 \Omega$). However, if the voltage on the GAIN+ pin is 1.6 V and the voltage on the GAIN- pin is 0 V (0 dB attenuation), $VGA_{ATT} = 0$ dB. This results in a total gain of 45.3 dB through the TGC path if the LNA input is unmatched or a total gain of 39.3 dB if the LNA input is matched.

In addition to the analog VGA attenuation described in Equation 2, the attenuation level can be digitally controlled in 3.5 dB increments. In this case, Equation 3 is still valid and the value of VGA_{ATT} is equal to the attenuation level set in SPI Register 0x011, Bits [7:4].

Low Noise Amplifier (LNA)

Good system sensitivity relies on a proprietary ultralow noise LNA at the beginning of the signal chain, which minimizes the noise contribution in the following VGA. Active impedance control optimizes noise performance for applications that benefit from input impedance matching.

The LNA inputs, LI-x, are capacitively coupled to the source. An on-chip bias generator establishes dc input bias voltages of approximately 2.2 V and centers the output common-mode levels at 1.5 V ($AVDD2$ divided by 2). A capacitor, C_{LG} , of the same value as the input coupling capacitor, C_s , is connected from the LG-x pins into ground.

The LNA supports three gain settings, 21.6 dB, 17.9 dB, or 15.6 dB, set through the SPI. Overload protection ensures quick recovery time from large input voltages.

Low value feedback resistors and the current driving capability of the output stage allow the LNA to achieve a low input referred noise voltage of 0.78 nV/ $\sqrt{\text{Hz}}$ (at a gain of 21.6 dB). On-chip resistor matching results in precise single-ended gains, which

are critical for accurate impedance control. The use of a fully differential topology and negative feedback minimizes distortion. Low second-order harmonic distortion is particularly important in harmonic ultrasound imaging applications.

Active Impedance Matching

The LNA consists of a single-ended voltage gain amplifier with differential outputs. The negative output is externally available on two output pins, LO-x and LOSW-x, that are controlled via internal switches. This configuration allows the active input impedance synthesis of three different impedance values (and an unterminated value) by connecting up to two external resistances in parallel and controlling the internal switch states via the SPI. For example, with a fixed gain of $8\times$ (17.9 dB), an active input termination is synthesized by connecting a feedback resistor between the negative output pin, LO-x, and the positive input pin, LI-x. This well known technique is used for interfacing multiple probe impedances to a single system. The input resistance (R_{IN}) calculation is shown in Equation 4.

$$R_{IN} = \frac{(R_{FB1} + 20 \Omega) \parallel (R_{FB2} + 20 \Omega) + 30 \Omega}{(1 + A/2)} \quad (4)$$

where:

R_{FB1} and R_{FB2} are the external feedback resistors.

20 Ω is the internal switch on resistance.

30 Ω is an internal series resistance common to the two internal switches.

$A/2$ is the single-ended gain or the gain from the LI-x inputs to the LO-x outputs.

R_{FB} can be equal to R_{FB1} , R_{FB2} , or $(R_{FB1} + 20 \Omega) \parallel (R_{FB2} + 20 \Omega)$, depending on the connection status of the internal switches.

Because the amplifier has a gain of $8\times$ from its input to its differential output, it is important to note that the gain, $A/2$, is the gain from the LI-x pin to the LO-x pin and that it is 6 dB less than the gain of the amplifier, or 12.1 dB ($4\times$). The input resistance is reduced by an internal bias resistor of 6 k Ω in parallel with the source resistance connected to the LI-x pin, with the LG-x pin ac grounded. Use Equation 5 to calculate the required R_{FB} for a desired R_{IN} , even for higher values of R_{IN} .

$$R_{IN} = \frac{(R_{FB1} + 20 \Omega) \parallel (R_{FB2} + 20 \Omega) + 30 \Omega}{(1 + A/2)} \parallel 6 \text{ k}\Omega \quad (5)$$

For example, to set R_{IN} to 200 Ω with a single-ended LNA gain of 12.1 dB ($4\times$), the value of R_{FB} from Equation 4 must be 950 Ω , while the switch for R_{FB2} is open. If the more accurate equation (Equation 5) is used to calculate R_{IN} , the value is then 194 Ω instead of 200 Ω , resulting in a gain error of less than 0.27 dB. Some factors, such as the presence of a dynamic source resistance, may influence the absolute gain accuracy more significantly. At higher frequencies, the input capacitance of the LNA must be considered. The user must determine the level of matching accuracy and adjust R_{FB} accordingly.

R_{FB} is the resulting impedance of the R_{FB1} and R_{FB2} combination (see Figure 33). Using Register 0x02C in the SPI memory map, the AD9670 can be programmed for four impedance matching options: three active terminations and one unterminated option. Table 8 shows an example of how to select R_{FB1} and R_{FB2} for 66 Ω , 100 Ω , and 200 Ω input impedances for LNA gain = 21.6 dB ($12\times$).

Table 8. Active Termination Example for LNA Gain = 21.6 dB, $R_{FB1} = 650 \Omega$, and $R_{FB2} = 1350 \Omega$

| Reg. 0x02C Value | R_s (Ω) | LO-x Switch | LOSW-x Switch | R_{FB} (Ω) | R_{IN} (Ω) ¹ |
|------------------|--------------------|-------------|---------------|-----------------------------|------------------------------------|
| 00 (default) | 100 | On | Off | R_{FB1} | 100 |
| 01 | 50 | On | On | $R_{FB1} \parallel R_{FB2}$ | 66 |
| 10 | 200 | Off | On | R_{FB2} | 200 |
| 11 | N/A ² | Off | Off | ∞ | ∞ |

¹ See Equation 4.

² N/A means not applicable.

The bandwidth (BW) of the LNA is greater than 80 MHz. Ultimately, the BW of the LNA limits the accuracy of the synthesized R_{IN} . For $R_{IN} = R_s$ up to about 200 Ω , the best match is between 100 kHz and 10 MHz, where the lower frequency limit is determined by the size of the ac coupling capacitors, and the upper limit is determined by the LNA BW. Furthermore, the input capacitance and R_s limit the BW at higher frequencies. Figure 34 shows R_{IN} vs. frequency for various values of R_{FB} .

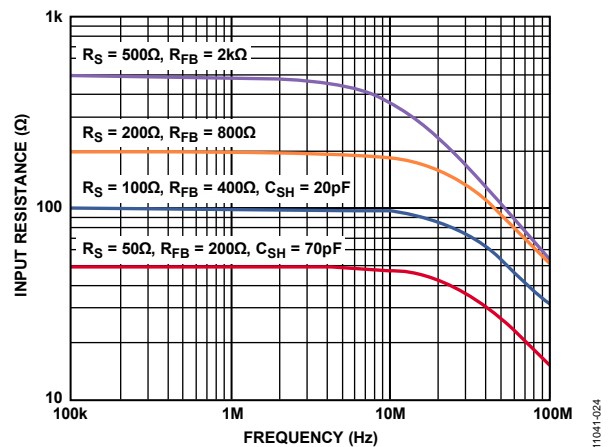

Figure 34. R_{IN} vs. Frequency for Various Values of R_{FB} (Effects of R_{SH} and C_{SH} Are Also Shown)

However, as seen for larger R_{IN} values, parasitic capacitance starts rolling off the signal BW before the LNA produces peaking. C_{SH} further degrades the match; therefore, do not use C_{SH} for values of R_{IN} that are greater than 100 Ω .

Table 9 lists the recommended values for R_{FB} and C_{SH} in terms of R_{IN} . C_{FB} is needed in series with R_{FB} because the dc levels at the LO-x pin and the LI-x pin are unequal.

Table 9. Active Termination External Component Values

| LNA Gain (dB) | R_{IN} (Ω) | R_{FB} (Ω) | Minimum C_{SH} (pF) |
|---------------|-----------------------|-----------------------|-----------------------|
| 15.6 | 50 | 150 | 90 |
| 17.9 | 50 | 200 | 70 |
| 21.6 | 50 | 300 | 50 |
| 15.6 | 100 | 350 | 30 |
| 17.9 | 100 | 450 | 20 |
| 21.6 | 100 | 650 | 10 |
| 15.6 | 200 | 750 | Not applicable |
| 17.9 | 200 | 950 | Not applicable |
| 21.6 | 200 | 1350 | Not applicable |

LNA Noise

The short-circuit noise voltage (input referred noise) is an important limit on system performance. The short-circuit noise voltage for the LNA is 0.78 nV/ $\sqrt{\text{Hz}}$ at a gain of 21.6 dB, including the VGA noise at a VGA postamplifier gain of 27 dB. These measurements, taken without a feedback resistor, provide the basis for calculating the input noise and noise figure (NF) performance. Figure 35 and Figure 36 are simulations of noise figure vs. R_S results with different input configurations and an input referred noise voltage of 2.5 nV/ $\sqrt{\text{Hz}}$ for the VGA. Underterminated ($R_{FB} = \infty$) operation exhibits the lowest equivalent input noise and noise figure. Figure 36 shows the noise figure vs. source resistance rising at low R_S —where the LNA voltage noise is large compared to the source noise—and at high R_S due to the noise contribution from R_{FB} . The lowest NF is achieved when R_S matches R_{IN} .

Figure 35 shows the relative noise figure performance. With an LNA gain of 21.6 dB, the input impedance is swept with R_S to preserve the match at each point. The noise figures for a source impedance of 50 Ω are 7 dB, 4 dB, and 2.5 dB for the shunt termination, active termination, and unterminated configurations, respectively. The noise figures for 200 Ω are 4.5 dB, 1.7 dB, and 1 dB, respectively.

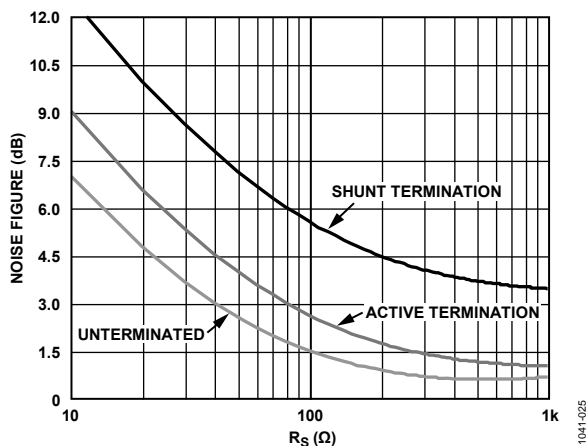

Figure 35. Noise Figure vs. R_S for Shunt Termination, Active Termination Matched, and Unterminated Inputs, $V_{GAIN} = 1.6 V$

Figure 36 shows the noise figure as it relates to R_S for various values of R_{IN} , which is helpful for design purposes.

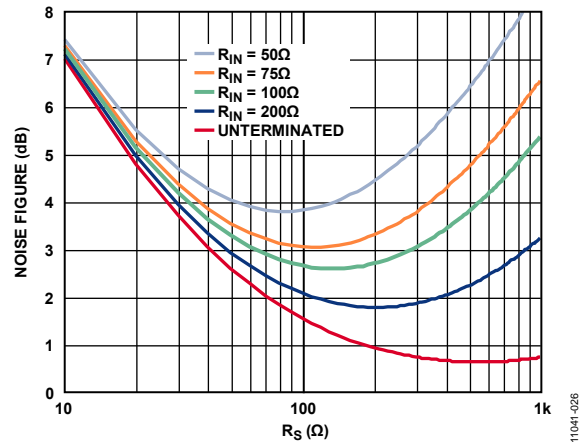

Figure 36. Noise Figure vs. R_S for Various Fixed Values of R_{IN} , Active Termination Matched Inputs, $V_{GAIN} = 1.6 V$

CLNA Connection

Attach a 1 nF capacitor from CLNA (Ball B7) to AVDD2.

DC Offset Correction/High-Pass Filter

The AD9670 LNA architecture is designed to correct for dc offset voltages that can develop on the external C_S capacitor due to leakage of the T/R switch during ultrasound transmit cycles. The dc offset correction, as shown in Figure 37, provides a feedback mechanism to the LG-x input of the LNA to correct for this dc voltage.

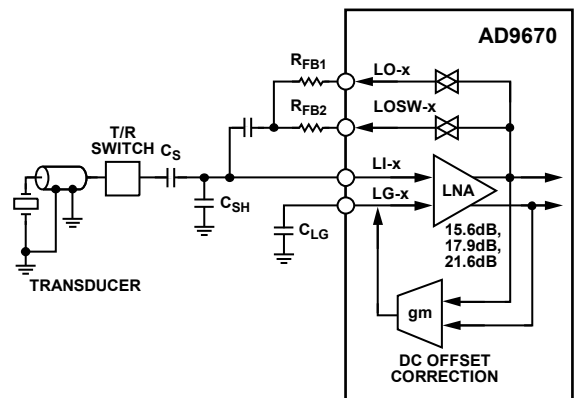

Figure 37. Simplified LNA Input Configuration

The feedback acts as high-pass filter providing dynamic correction of the dc offset. The cutoff frequency of the high-pass filter response is dependent on the value of the C_{LG} capacitor, the gain of the LNA (LNA_{GAIN}), and the transconductance (g_m) of the feedback transconductance amplifier. The g_m value is programmed in Register 0x120, Bits[4:3]. C_S must be equal to C_{LG} for proper operation.

Table 10. High-Pass Filter Cutoff Frequency, f_{HP} , for $C_{LG} = 10$ nF

| Reg. 0x120, Bits[4:3] | g_m (mS) | $LNA_{GAIN} = 15.6$ dB (kHz) | $LNA_{GAIN} = 17.9$ dB (kHz) | $LNA_{GAIN} = 21.6$ dB (kHz) |
|-----------------------|------------|------------------------------|------------------------------|------------------------------|
| 00 (default) | 0.5 | 41 | 55 | 83 |
| 01 | 1.0 | 83 | 110 | 167 |
| 10 | 1.5 | 133 | 178 | 267 |
| 11 | 2.0 | 167 | 220 | 330 |

For other values of C_{LG} , determine the high-pass filter cutoff frequency by scaling the values from Table 10 or calculating based on C_{LG} , LNA_{GAIN} , and g_m , as shown in Equation 6.

$$f_{HP}(C_{LG}) = \frac{1}{2 \times \pi} \times LNA_{GAIN} \times \frac{g_m}{C_{LG}} = f_{HP} \text{ (see Table 10)} \times \frac{10 \text{ nF}}{C_{LG}} \quad (6)$$

Variable Gain Amplifier (VGA)

The differential X-AMP VGA provides precise input attenuation and interpolation. It has a low input referred noise of 2.5 nV/ $\sqrt{\text{Hz}}$ and excellent gain linearity. The VGA is driven by a fully differential input signal from the LNA. The X-AMP architecture produces a linear in dB gain law conformance and low distortion levels—deviating by only ± 0.5 dB or less from the ideal. The gain slope is monotonic with respect to the control voltage and is stable with variations in process, temperature, and supply. The resulting total gain range is 45 dB, which allows range loss at the endpoints. The X-AMP inputs are part of a PGA that completes the VGA. The PGA in the VGA is programmable to a gain of 21 dB, 24 dB, 27 dB, or 30 dB. This allows the optimization of channel gain for different imaging modes in the ultrasound system. The VGA bandwidth is greater than 100 MHz. The input stage is designed to ensure excellent frequency response uniformity across the gain setting. For TGC mode, this uniformity minimizes time delay variation across the gain range.

Gain Control

The analog gain control interface, $GAIN_{\pm}$, is a differential input. V_{GAIN} varies the gain of all VGAs through the interpolator by selecting the appropriate input stages connected to the input attenuator. The nominal V_{GAIN} range is 14 dB/V from -1.6 V to $+1.6$ V, with the best gain linearity from approximately -1.44 V to $+1.44$ V, where the error is typically less than ± 0.5 dB. For V_{GAIN} voltages of greater than $+1.44$ V and less than -1.44 V, the error increases. The value of $GAIN_{\pm}$ can exceed the supply voltage by 1 V without gain foldover.

Gain control response time is less than 750 ns to settle within 10% of the final value for a change from minimum to maximum gain.

The differential input pins, $GAIN+$ and $GAIN-$, can be interfaced as shown in Figure 38. DC couple the $GAIN+$ and $GAIN-$ pins, and drive them to accommodate a 3.2 V full-scale input.

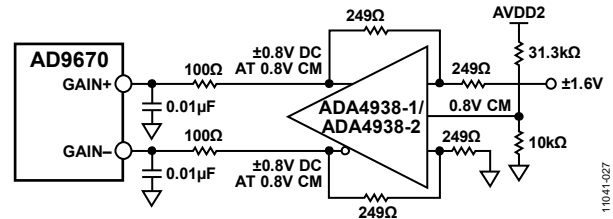
Figure 38. Differential $GAIN_{\pm}$ Pin Configuration

Disable the analog gain control and digitally control the attenuator using SPI Register 0x011, Bits[7:4]. The control range is 45 dB, and the step size is 3.5 dB.

VGA Noise

In a typical application, a VGA compresses a wide dynamic range input signal to within the input span of an ADC. The input referred noise of the LNA limits the minimum resolvable input signal, whereas the output referred noise, which depends primarily on the VGA, limits the maximum instantaneous dynamic range that can be processed at any one particular gain control voltage. This latter limit is set in accordance with the total noise floor of the ADC.

The output referred noise is a flat 40 nV/ $\sqrt{\text{Hz}}$ (postamplifier gain = 24 dB) over most of the gain range because it is dominated by the fixed output referred noise of the VGA. At the high end of the gain control range, the noise of the LNA and of the source prevail. The input referred noise reaches its minimum value near the maximum gain control voltage, where the input referred contribution of the VGA is miniscule.

At lower gains, the input referred noise and, therefore, the noise figure, increases as the gain decreases. The instantaneous dynamic range of the system is not lost, however, because the input capacity increases as the input referred noise increases. The contribution of the ADC noise floor has the same dependence. The important relationship is the magnitude of the VGA output noise floor relative to that of the ADC.

Gain control noise is a concern in very low noise applications. Thermal noise in the gain control interface can modulate the channel gain. The resulting noise is proportional to the output signal level and is usually evident only when a large signal is present. Take care to minimize noise impinging at the $GAIN_{\pm}$ inputs. Use an external RC filter to remove V_{GAIN} source noise. The filter bandwidth must be sufficient to accommodate the desired control bandwidth and attenuate unwanted switching noise from the external DACs used to drive the gain control.

The AD9670 can bypass the $GAIN_{\pm}$ inputs and control the gain of the attenuator digitally (see the Gain Control section). This mode removes any external noise contributions when active gain control is not needed.

Antialiasing Filter

The filter that the signal reaches prior to the ADC is used to reject dc signals and to band limit the signal for antialiasing. The antialiasing filter is a combination of a single-pole high-pass filter and a second-order low-pass filter. The high-pass filter can be configured at a ratio of the low-pass filter cutoff. This is selectable through Register 0x02B.

The filter uses on-chip tuning to trim the capacitors and, in turn, to set the desired low-pass cutoff frequency and reduce variations. The default -3 dB low-pass filter cutoff is $1/3$, $1/4.5$,

or $1/6$ of the ADC sample clock rate. The cutoff can be scaled to 0.75, 0.8, 0.9, 1.0, 1.13, 1.25, or 1.45 times this frequency through Register 0x00F. The cutoff tolerance ($\pm 10\%$) is maintained from 8 MHz to 18 MHz for low band mode and 13.5 MHz to 30 MHz for high band mode. Table 11 and Table 12 calculate the valid SPI-selectable low-pass filter settings and expected cutoff frequencies for the low band and high band mode at the minimum sample frequency and the maximum sample frequency in each speed mode.

Table 11. SPI-Selectable Low-Pass Filter Cutoff Options for Low Band Mode at Example Sampling Frequencies

| Address 0x00F, Bits[7:3] | LPF Cutoff Frequency (MHz) | Sampling Frequency (MHz) | | | | |
|--------------------------------|--|--------------------------------|--------------------------------|--------------------------------|--------------------------------|--------------------------------|
| | | 20.5 | 40 | 65 | 80 | 125 |
| 0 0000 | $1.45 \times (1/3) \times f_{\text{SAMPLE}}$ | 9.91 | Out of tunable filter range | Out of tunable filter range | Out of tunable filter range | Out of tunable filter range |
| 0 0001 | $1.25 \times (1/3) \times f_{\text{SAMPLE}}$ | 8.54 | 16.67 | Out of tunable filter range | Out of tunable filter range | Out of tunable filter range |
| 0 0010 | $1.13 \times (1/3) \times f_{\text{SAMPLE}}$ | Out of tunable filter range | 15.00 | Out of tunable filter range | Out of tunable filter range | Out of tunable filter range |
| 0 0011 | $1.0 \times (1/3) \times f_{\text{SAMPLE}}$ | Out of tunable filter range | 13.33 | Out of tunable filter range | Out of tunable filter range | Out of tunable filter range |
| 0 0100 | $0.9 \times (1/3) \times f_{\text{SAMPLE}}$ | Out of tunable filter range | 12.00 | Out of tunable filter range | Out of tunable filter range | Out of tunable filter range |
| 0 0101 | $0.8 \times (1/3) \times f_{\text{SAMPLE}}$ | Out of tunable filter range | 10.67 | 17.33 | Out of tunable filter range | Out of tunable filter range |
| 0 0110 | $0.75 \times (1/3) \times f_{\text{SAMPLE}}$ | Out of tunable filter range | 10.00 | 16.25 | 16.82 | Out of tunable filter range |
| 0 1000 | $1.45 \times (1/4.5) \times f_{\text{SAMPLE}}$ | Out of tunable filter range | 12.89 | 20.94 | Out of tunable filter range | Out of tunable filter range |
| 0 1001 | $1.25 \times (1/4.5) \times f_{\text{SAMPLE}}$ | Out of tunable filter range | 11.11 | 18.06 | Out of tunable filter range | Out of tunable filter range |
| 0 1010 | $1.13 \times (1/4.5) \times f_{\text{SAMPLE}}$ | Out of tunable filter range | 10.00 | 16.25 | Out of tunable filter range | Out of tunable filter range |
| 0 1011 | $1.0 \times (1/4.5) \times f_{\text{SAMPLE}}$ | Out of tunable filter range | 8.89 | 14.44 | 17.78 | Out of tunable filter range |
| 0 1100 | $0.9 \times (1/4.5) \times f_{\text{SAMPLE}}$ | Out of tunable filter range | 8.00 | 13.00 | 16.00 | Out of tunable filter range |
| 0 1101 | $0.8 \times (1/4.5) \times f_{\text{SAMPLE}}$ | Out of tunable filter range | Out of tunable filter range | 11.56 | 14.22 | Out of tunable filter range |
| 0 1110 | $0.75 \times (1/4.5) \times f_{\text{SAMPLE}}$ | Out of tunable filter range | Out of tunable filter range | 10.83 | 13.33 | 17.50 |
| 1 0000 | $1.45 \times (1/6) \times f_{\text{SAMPLE}}$ | Out of tunable filter range | 9.67 | 15.71 | Out of tunable filter range | Out of tunable filter range |
| 1 0001 | $1.25 \times (1/6) \times f_{\text{SAMPLE}}$ | Out of tunable filter range | 8.33 | 13.54 | 16.67 | Out of tunable filter range |
| 1 0010 | $1.13 \times (1/6) \times f_{\text{SAMPLE}}$ | Out of tunable filter range | Out of tunable filter range | 12.19 | 15.00 | Out of tunable filter range |
| 1 0011 | $1.0 \times (1/6) \times f_{\text{SAMPLE}}$ | Out of tunable filter range | Out of tunable filter range | 10.83 | 13.33 | Out of tunable filter range |
| 1 0100 | $0.9 \times (1/6) \times f_{\text{SAMPLE}}$ | Out of tunable filter range | Out of tunable filter range | 9.75 | 12.00 | Out of tunable filter range |
| 1 0101 | $0.8 \times (1/6) \times f_{\text{SAMPLE}}$ | Out of tunable filter range | Out of tunable filter range | 8.67 | 10.67 | 16.67 |
| 1 0110 | $0.75 \times (1/6) \times f_{\text{SAMPLE}}$ | Out of tunable filter range | Out of tunable filter range | 8.13 | 10.00 | 15.63 |

Table 12. SPI-Selectable Low-Pass Filter Cutoff Options for High Band Mode at Example Sampling Frequencies

| Address 0x00F, Bits[7:3] | LPF Cutoff Frequency (MHz) | Sampling Frequency (MHz) | | | | |
|-----------------------------|--|-----------------------------|-----------------------------|-----------------------------|-----------------------------|-----------------------------|
| | | 20.5 | 40 | 65 | 80 | 125 |
| 0 0000 | $1.45 \times (1/3) \times f_{\text{SAMPLE}}$ | Out of tunable filter range | 19.33 | Out of tunable filter range | Out of tunable filter range | Out of tunable filter range |
| 0 0001 | $1.25 \times (1/3) \times f_{\text{SAMPLE}}$ | Out of tunable filter range | 16.67 | 27.08 | Out of tunable filter range | Out of tunable filter range |
| 0 0010 | $1.13 \times (1/3) \times f_{\text{SAMPLE}}$ | Out of tunable filter range | 15.00 | 24.38 | 30.00 | Out of tunable filter range |
| 0 0011 | $1.0 \times (1/3) \times f_{\text{SAMPLE}}$ | Out of tunable filter range | Out of tunable filter range | 21.67 | 26.67 | Out of tunable filter range |
| 0 0100 | $0.9 \times (1/3) \times f_{\text{SAMPLE}}$ | Out of tunable filter range | Out of tunable filter range | 19.50 | 24.00 | Out of tunable filter range |
| 0 0101 | $0.8 \times (1/3) \times f_{\text{SAMPLE}}$ | Out of tunable filter range | Out of tunable filter range | 17.33 | 21.33 | Out of tunable filter range |
| 0 0110 | $0.75 \times (1/3) \times f_{\text{SAMPLE}}$ | Out of tunable filter range | Out of tunable filter range | 16.25 | 20.00 | Out of tunable filter range |
| 0 1000 | $1.45 \times (1/4.5) \times f_{\text{SAMPLE}}$ | Out of tunable filter range | Out of tunable filter range | 20.94 | 25.78 | Out of tunable filter range |
| 0 1001 | $1.25 \times (1/4.5) \times f_{\text{SAMPLE}}$ | Out of tunable filter range | Out of tunable filter range | 18.06 | 22.22 | Out of tunable filter range |
| 0 1010 | $1.13 \times (1/4.5) \times f_{\text{SAMPLE}}$ | Out of tunable filter range | Out of tunable filter range | 16.25 | 20.00 | Out of tunable filter range |
| 0 1011 | $1.0 \times (1/4.5) \times f_{\text{SAMPLE}}$ | Out of tunable filter range | Out of tunable filter range | 14.44 | 17.78 | 27.78 |
| 0 1100 | $0.9 \times (1/4.5) \times f_{\text{SAMPLE}}$ | Out of tunable filter range | Out of tunable filter range | Out of tunable filter range | 16.00 | 25.00 |
| 0 1101 | $0.8 \times (1/4.5) \times f_{\text{SAMPLE}}$ | Out of tunable filter range | Out of tunable filter range | Out of tunable filter range | 14.22 | 22.22 |
| 0 1110 | $0.75 \times (1/4.5) \times f_{\text{SAMPLE}}$ | Out of tunable filter range | Out of tunable filter range | Out of tunable filter range | Out of tunable filter range | 20.83 |
| 1 0000 | $1.45 \times (1/6) \times f_{\text{SAMPLE}}$ | Out of tunable filter range | Out of tunable filter range | 15.71 | 19.33 | Out of tunable filter range |
| 1 0001 | $1.25 \times (1/6) \times f_{\text{SAMPLE}}$ | Out of tunable filter range | Out of tunable filter range | 13.54 | 16.67 | 26.04 |
| 1 0010 | $1.13 \times (1/6) \times f_{\text{SAMPLE}}$ | Out of tunable filter range | Out of tunable filter range | Out of tunable filter range | 15.00 | 23.44 |
| 1 0011 | $1.0 \times (1/6) \times f_{\text{SAMPLE}}$ | Out of tunable filter range | Out of tunable filter range | Out of tunable filter range | Out of tunable filter range | 20.83 |
| 1 0100 | $0.9 \times (1/6) \times f_{\text{SAMPLE}}$ | Out of tunable filter range | Out of tunable filter range | Out of tunable filter range | Out of tunable filter range | 18.75 |
| 1 0101 | $0.8 \times (1/6) \times f_{\text{SAMPLE}}$ | Out of tunable filter range | Out of tunable filter range | Out of tunable filter range | Out of tunable filter range | 16.67 |
| 1 0110 | $0.75 \times (1/6) \times f_{\text{SAMPLE}}$ | Out of tunable filter range | Out of tunable filter range | Out of tunable filter range | Out of tunable filter range | 15.63 |

Tuning is normally off to avoid changing the capacitor settings during critical times. The tuning circuit is enabled through the SPI. It is disabled automatically after 512 cycles of the ADC sample clock. Initializing the tuning of the filter must be performed after initial power-up and after reprogramming the filter cutoff scaling or ADC sample rate. The tuning is initiated in Register 0x02B, Bit 6.

A total of four SPI-programmable settings allow the user to vary the high-pass filter cutoff frequency as a function of the low-pass cutoff frequency. Two examples are shown in Table 13: one example is for an 8 MHz low-pass cutoff frequency, and the other example is for an 18 MHz low-pass cutoff frequency. In both examples, as the ratio decreases, the amount of rejection on the low-end frequencies increases. Therefore, making the entire antialiasing filter frequency pass band narrow can reduce low frequency noise or maximize dynamic range for harmonic processing.

Table 13. High-Pass Filter Cutoff Options

| Reg. 0x02B[1:0] High-Pass Filter Cutoff | Ratio ¹ | High-Pass Cutoff Frequency | |
|--|--------------------|----------------------------|--------------------------|
| | | Low-Pass Cutoff = 8 MHz | Low-Pass Cutoff = 18 MHz |
| 00 (default) | 12.00 | 670 kHz | 1.5 MHz |
| 01 | 9.00 | 890 kHz | 2.0 MHz |
| 10 | 6.00 | 1.33 MHz | 3.0 MHz |
| 11 | 3.00 | 2.67 MHz | 6.0 MHz |

¹ Ratio is the low-pass filter cutoff frequency/high-pass filter cutoff frequency.

Antialiasing Filter/VGA Test Mode

For debug and testing, there is a bypass switch to view the antialiasing filter output on the GPO2 and GPO3 pins. Enable this mode using SPI Register 0x109, Bit 4. The differential antialiasing filter output of only one channel can be accessed at a time. The dc output voltage is 1.5 V (or AVDD2/2) and the maximum ac output voltage is 2 V p-p.

ADC

The AD9670 uses a pipelined ADC architecture. The quantized output from each stage is combined into a 14-bit result in the digital correction logic. The pipelined architecture permits the first stage to operate on a new input sample and the remaining stages to operate on preceding samples. Sampling occurs on the rising edge of the clock.

The output staging block aligns the data, corrects errors, and passes the data to the output buffers. The data is then serialized and aligned to the frame and output clocks.

Clock Input Considerations

For optimum performance, clock the AD9670 sample clock inputs (CLK+ and CLK-) with a differential signal. This signal is typically ac-coupled into the CLK+ and CLK- pins via a transformer or capacitors. These pins are biased internally and require no additional bias.

Figure 39 shows the preferred method for clocking the AD9670. A low jitter clock source, such as the Valpey Fisher oscillator, VFAC3-BHL-50 MHz, is converted from single-ended to differential using an RF transformer. The back to back Schottky diodes across the secondary transformer limit clock excursions into the AD9670 to approximately 0.8 V p-p differential. This helps prevent the large voltage swings of the clock from feeding through to other portions of the AD9670, and it preserves the fast rise and fall times of the signal, which are critical to low jitter performance.

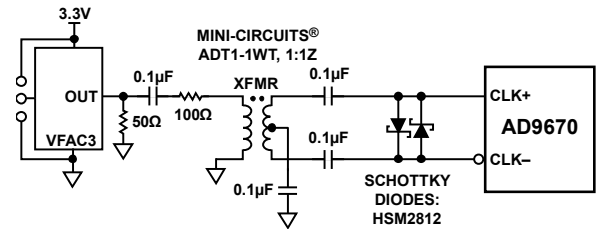
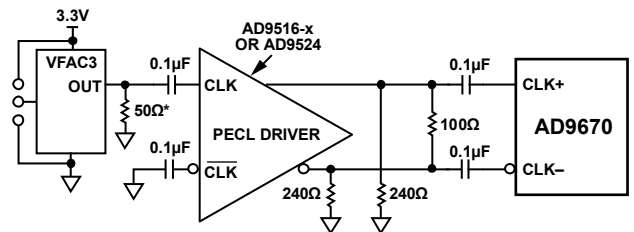

Figure 39. Transformer-Coupled Differential Clock

If a low jitter clock is available, another option is to ac-couple a differential PECL signal to the sample clock input pins, as shown in Figure 40. Analog Devices, Inc., offers a family of clock drivers with excellent jitter performance, including the AD9516-0, AD9516-1, AD9516-2, AD9516-3, and AD9516-5 (these five devices are represented by AD9516-x in Figure 40, Figure 41, and Figure 42), as well as the AD9524.



*50Ω RESISTOR IS OPTIONAL.

Figure 40. Differential PECL Sample Clock

A third option is to ac couple a differential LVDS signal to the sample clock input pins, as shown in Figure 41.

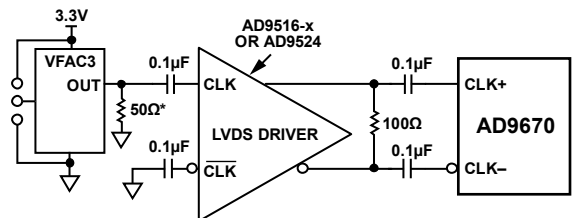

*50Ω RESISTOR IS OPTIONAL.

Figure 41. Differential LVDS Sample Clock

In some applications, it is acceptable to drive the sample clock inputs with a single-ended CMOS signal. In such applications, drive CLK+ directly from a CMOS gate, and bypass the CLK- pin to ground with a 0.1 μF capacitor (see Figure 42).

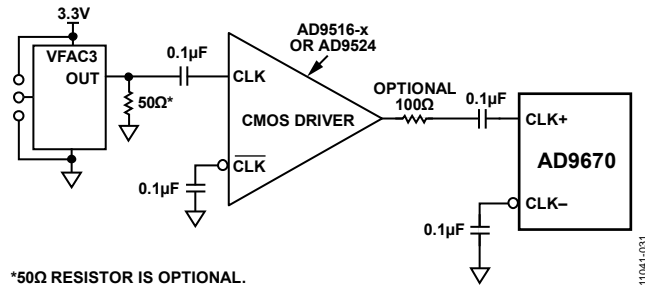

*50 Ω RESISTOR IS OPTIONAL.

Figure 42. Single-Ended, 1.8 V CMOS Sample Clock

Clock Duty Cycle Considerations

Typical high speed ADCs use both clock edges to generate a variety of internal timing signals. As a result, these ADCs may be sensitive to the clock duty cycle. Commonly, a 5% tolerance is required on the clock duty cycle to maintain dynamic performance characteristics. The AD9670 contains a duty cycle stabilizer (DCS) that retimes the nonsampling edge, providing an internal clock signal with a nominal 50% duty cycle. This allows a wide range of clock input duty cycles without affecting the performance of the AD9670. When the DCS is on, noise and distortion performance are nearly flat for a wide range of duty cycles. However, some applications may require the DCS function to be off. If so, keep in mind that the dynamic range performance may be affected when operated in this mode.

The duty cycle stabilizer uses a delay-locked loop (DLL) to create the nonsampling edge. As a result, any changes to the sampling frequency require approximately eight clock cycles to allow the DLL to acquire and lock to the new rate.

Clock Jitter Considerations

High speed, high resolution ADCs are sensitive to the quality of the clock input. The degradation in SNR at a given input frequency (f_A) due only to aperture jitter (t_j) can be calculated as follows:

$$\text{SNR Degradation} = 20 \times \log_{10}(1/2 \times \pi \times f_A \times t_j) \quad (7)$$

In this equation, the rms aperture jitter represents the root mean square of all jitter sources, including the clock input, analog input signal, and ADC aperture jitter (see Figure 43).

Treat the clock input as an analog signal when aperture jitter may affect the dynamic range of the AD9670. Separate power supplies for clock drivers from the ADC output driver supplies to avoid modulating the clock signal with digital noise. Low jitter, crystal-controlled oscillators make the best clock sources, such as the Valpey Fisher VFAC3 series. If the clock is generated from another type of source (by gating, dividing, or other methods), retime it by the original clock during the last step.

For more information about how jitter performance relates to ADCs, refer to the AN-501 Application Note and the AN-756 Application Note.

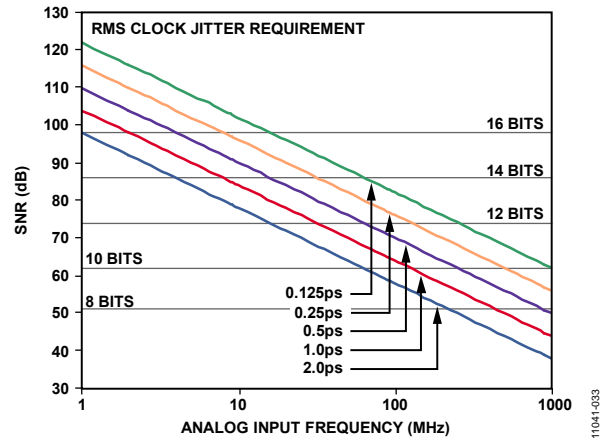

Figure 43. Ideal SNR vs. Analog Input Frequency and Jitter

Power Dissipation and Power-Down Mode

The power dissipated by the AD9670 is proportional to its sample rate. The digital power dissipation does not vary significantly because it is determined primarily by the DRVDD supply and the bias current of the LVDS output drivers. The AD9670 features scalable LNA bias currents (see Table 27, Register 0x012). The default LNA bias current settings are high.

By asserting the PDWN pin high, the AD9670 is placed into power-down mode. In this state, the device typically dissipates 5 mW. During power-down, the LVDS output drivers are placed into a high impedance state. The AD9670 returns to normal operating mode when the PDWN pin is pulled low. This pin is only 1.8 V tolerant. To drive the PDWN pin from a 3.3 V logic level, insert a 1 k Ω resistor in series with this pin to limit the current.

By asserting the STBY pin high, the AD9670 is placed into a standby mode. In this state, the device typically dissipates 630 mW. During standby, the entire device, except the internal references, is powered down. The LVDS output drivers are placed into a high impedance state. This mode is well suited for applications that require power savings because it allows the device to power down when not in use, and then be quickly powered up. The time to power the device back up is also greatly reduced. The AD9670 returns to normal operating mode when the STBY pin is pulled low. This pin is only 1.8 V tolerant. To drive the STBY pin from a 3.3 V logic level, insert a 1 k Ω resistor in series with this pin to limit the current.

In power-down mode, low power dissipation is achieved by shutting down the reference, reference buffer, PLL, and biasing networks. The decoupling capacitors on VREF are discharged when entering power-down mode and must be recharged when returning to normal operation. As a result, the wake-up time is related to the time spent in the power-down mode: shorter cycles result in proportionally shorter wake-up times. To restore the device to full operation, approximately 375 μs is required when using the recommended 1 μF and 0.1 μF decoupling capacitors on the VREF pin and the 0.01 μF decoupling capacitors on the GAIN \pm pins. Most of this time is dependent on the gain decoupling:

higher value decoupling capacitors on the GAIN± pins result in longer wake-up times.

A number of other power-down options are available when using the SPI port interface. The user can individually power down each channel or put the entire device into standby mode. This allows the user to keep the internal PLL powered up when fast wake-up times are required. The wake-up time is slightly dependent on gain. To achieve a 2 μ s wake-up time when the device is in standby mode, 0.8 V must be applied to the GAIN± pins.

Power and Ground Connection Recommendations

When connecting power to the AD9670, it is recommended that two separate 1.8 V supplies be used: one for analog supply (AVDD1) and one for digital supply (DRVDD). If only one 1.8 V supply is available, route this supply to the AVDD1 pin first, and then tap the supply off and isolate it with a ferrite bead or a filter choke preceded by decoupling capacitors for the DRVDD pin.

If the user does not use the digital demodulator and decimator functions for post ADC processing, the DVDD pin can be tied to the 1.8 V DRVDD supply. If this is the case, route the DVDD supply first, tapped the supply off, and isolated it with a ferrite bead or filter choke preceded by decoupling capacitors for the DRVDD pin. It is not recommended to use the same supply for AVDD1, DVDD, and DRVDD.

Use several decoupling capacitors on all supplies to cover both high and low frequencies. Locate these capacitors close to the point of entry at the PCB level and close to the device, with minimal trace lengths.

A single PCB ground plane is sufficient when using the AD9670. With proper decoupling and smart partitioning of the analog, digital, and clock sections of the PCB, optimum performance is easily achieved.

Advanced Power Control

Not all channels are required during all periods of scanning in an ultrasound system. Use the POWER_START and POWER_STOP values in the vector profile to delay the channel startup and to turn the channel off after a certain number of samples. These counters are relative to TX_TRIG±. The analog circuitry must power up before the digital circuitry, and the advance time (POWER_SETUP) for powering up the analog circuitry, before POWER_START, is set up in Register 0x112, Bits[4:0] (see Table 27).

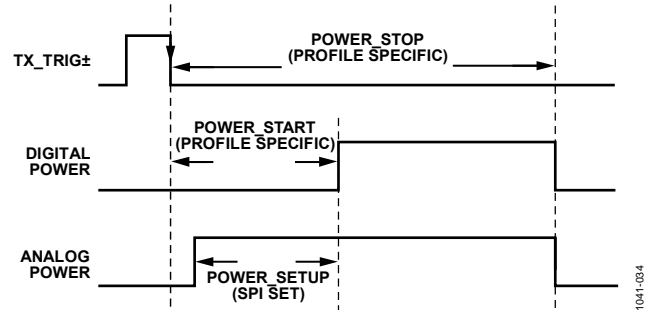

Figure 44. Power Sequencing

Digital Outputs and Timing

The AD9670 differential outputs conform to the ANSI-644 LVDS standard on default power-up. This standard can be changed to a low power, reduced signal option similar to the IEEE 1596.3 standard via the SPI using Register 0x015, Bit 7. This LVDS standard can further reduce the overall power dissipation of the device by approximately 36 mW.

The LVDS driver current is derived on chip and sets the output current at each output equal to a nominal 3.5 mA. A 100 Ω differential termination resistor placed at the LVDS receiver inputs results in a nominal 350 mV swing at the receiver.

The AD9670 LVDS outputs facilitate interfacing with LVDS receivers in custom ASICs and FPGAs that have LVDS capability for superior switching performance in noisy environments. Single point-to-point network topologies are recommended with a 100 Ω termination resistor placed as close to the receiver as possible. No far-end receiver termination and poor differential trace routing may result in timing errors. The trace length must be no longer than 24 inches. Keep the differential output traces close together and at equal lengths.

An example of the LVDS output using the ANSI-644 standard (default) data eye and a time interval error (TIE) jitter histogram with trace lengths of less than 24 inches on regular FR-4 material is shown in Figure 45 and Figure 46. Figure 47 and Figure 48 show examples of the trace lengths exceeding 24 inches on regular FR-4 material. Notice that the TIE jitter histogram reflects the decrease of the data eye opening as the edge deviates from the ideal position; therefore, the user must determine whether the waveforms meet the timing budget of the design when the trace lengths exceed 24 inches.

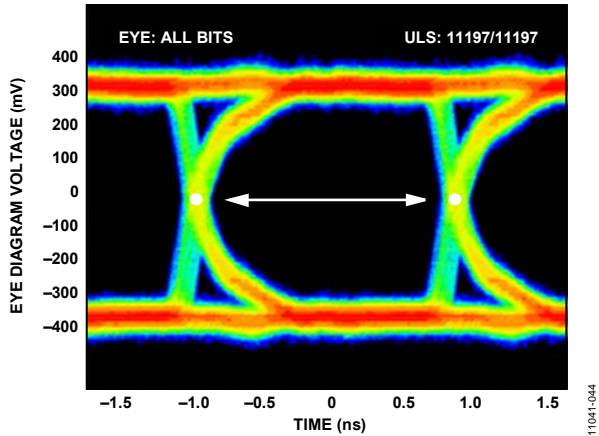

Figure 45. Data Eye for LVDS Outputs in ANSI-644 Mode with Trace Lengths of Less Than 24 Inches on Standard FR-4 Material

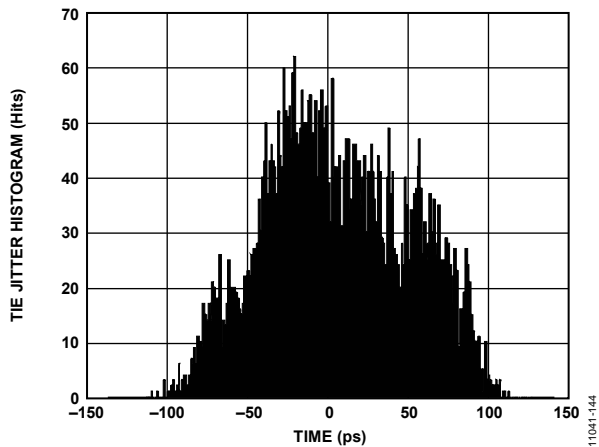

Figure 46. TIE Jitter Histogram for LVDS Outputs in ANSI-644 Mode with Trace Lengths of Less Than 24 Inches on Standard FR-4 Material

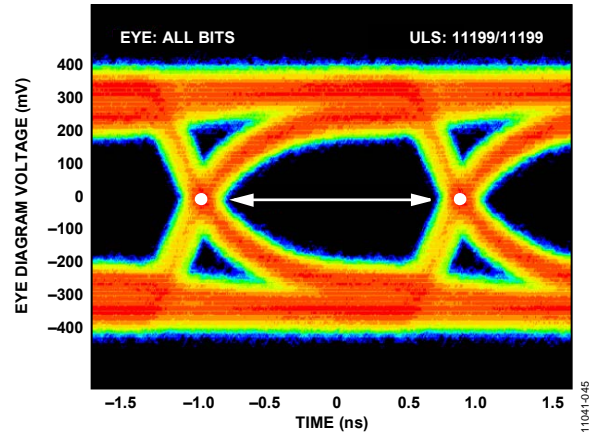

Figure 47. Data Eye for LVDS Outputs in ANSI-644 Mode with Trace Lengths of Greater Than 24 Inches on Standard FR-4 Material

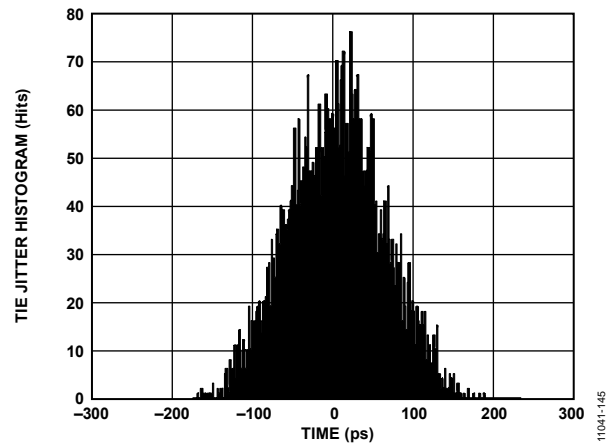

Figure 48. TIE Jitter Histogram for LVDS Outputs in ANSI-644 Mode with Trace Lengths of Greater Than 24 Inches on Standard FR-4 Material

Additional SPI options allow the user to further increase the internal current of all eight outputs to drive longer trace lengths. Even though this produces sharper rise and fall times on the data edges, it is less prone to bit errors and improves frequency distribution. The power dissipation of the DRVDD supply increases when this option is used.

In cases that require increased drive current, Register 0x015 allows the user to adjust the drivers from 2.0 mA to 3.72 mA. Note that this feature requires Bit 3 of Register 0x015 to be enabled. The drive current can be adjusted for both ANSI-644 and IEEE (low power) mode. See Table 27 for more details.

The format of the output data is twos complement by default. Table 14 provides an example of the output coding format. To change the output data format to twos complement, see the Memory Map section.

Table 14. Digital Output Coding with RF Decimator Bypassed, Demodulator Bypassed, and Baseband Decimator Bypassed

| Code | (V_{IN+}) – (V_{IN-}), Input Span = 2 V p-p (V) | Digital Output Mode: Twos Complement (D13 to D0) |
|-------|--|---|
| 16384 | +1.00 | 01 1111 1111 1111 |
| 8192 | 0.00 | 00 0000 0000 0000 |
| 8191 | –0.000488 | 11 1111 1111 1111 |
| 0 | –1.00 | 10 0000 0000 0000 |

Digital data from each channel is serialized based on the number of lanes that are enabled (see Table 27). The maximum data rate for each serial output lane is 1 Gbps. For 1 channel/lane with a 14-bit data stream and an ADC sample clock of 70 MHz, the output data rate is 980 Mbps (14 bits \times 70 MHz = 980 Mbps) with the RF decimator bypassed, the demodulator bypassed, and the baseband decimator bypassed. For higher sample rates, enabling the RF decimator is required.

Two output clocks are provided to assist in capturing data from the AD9670. DCO \pm clocks the output data and is equal to seven times the sampling clock rate in 14-bit mode with the RF decimator

bypassed, the demodulator bypassed, and the baseband decimator bypassed. Data is clocked out of the AD9670 and must be captured on the rising and falling edges of DCO \pm , which support double data rate (DDR) capturing. The frame clock output (FCO \pm) signals the start of a new output byte and is equal to the sampling clock rate.

A 12-, 14-, or 16-bit serial stream can also be initiated from SPI Register 0x021, Bits[1:0]. The user can implement different serial streams and test device compatibility with lower and higher resolution systems using these modes.

When using the SPI, all the data outputs can also be inverted from their nominal state by setting Bit 2 in the output mode register (Register 0x014). This is not to be confused with inverting the serial stream to an LSB first mode. In default mode, as shown in Figure 2, the MSB is represented first in the data output serial stream. However, this order this can be inverted so that the LSB is represented first in the data output serial stream.

Output Zero Stuffing

A zero stuffing feature handles the various decimation rates and complex (IQ) vs. real samples. As the decimation rates increase, relatively large amounts of zero stuffing can occur in the output data stream.

Table 15. Flexible Output Test Modes

| Output Test Mode Bit Sequence | Pattern Name | Digital Output Word 1 | Digital Output Word 2 | Subject to Resolution Select |
|-------------------------------|-----------------------|-----------------------------------|-----------------------------------|------------------------------|
| 0000 | Off (default) | Not applicable | Not applicable | Not applicable |
| 0001 | Midscale short | 10 0000 0000 0000 | Same | Yes |
| 0010 | +Full-scale short | 11 1111 1111 1111 | Same | Yes |
| 0011 | –Full-scale short | 00 0000 0000 0000 | Same | Yes |
| 0100 | Checkerboard | 10 1010 1010 1010 | 01 0101 0101 0101 | No |
| 0101 | PN sequence long | Not applicable | Not applicable | Yes |
| 0110 | PN sequence short | Not applicable | Not applicable | Yes |
| 0111 | One-/zero-word toggle | 11 1111 1111 1111 | 00 0000 0000 0000 | No |
| 1000 | User input | Register 0x019 and Register 0x01A | Register 0x01B and Register 0x01C | No |

There are nine digital output test pattern options available that can be initiated through the SPI. The test pattern options are useful when validating receiver capture and timing. See Table 15 for the available output bit sequencing options. Some test patterns have two serial sequential words and can be alternated in various ways, depending on the test pattern chosen. Note that some patterns may not adhere to the data format select option. In addition, custom user defined test patterns can be assigned in the user pattern registers (Address 0x019 through Address 0x01C). All test mode options except pseudorandom number (PN) sequence short and PN sequence long can support 8- to 14-bit word lengths to verify data capture to the receiver.

The PN sequence short pattern produces a pseudorandom bit sequence that repeats itself every $2^9 - 1$ bits, or 511 bits. A description of the PN sequence short and how it is generated can be found in Section 5.1 of the ITU-T O.150 (05/96) standard. The only difference from the standard is that the starting value is a specific value instead of all 1s (see Table 16 for the initial values).

The PN sequence long pattern produces a pseudorandom bit sequence that repeats itself every $2^{23} - 1$ bits, or 8,388,607 bits. A description of the PN sequence long and how it generates is found in Section 5.6 of the ITU-T O.150 (05/96) standard. The only differences from the standard are that the starting value is a specific value instead of all 1s, and that the AD9670 inverts the bit stream (see Table 16 for the initial values). The output sample size depends on the selected bit length.

Table 16. PN Sequence

| PN Sequence | Initial Value | First Three Output Samples (MSB First, 16-Bit) |
|-------------|---------------|--|
| Short | 0x092 | 0x496F, 0xC9A9, 0x980C |
| Long | 0x003 | 0xFF5C, 0x0029, 0xB80A |

See the Memory Map section for information on how to change these additional digital output timing features via the SPI.

SDIO Pin

The SDIO pin is required to operate the SPI. It has an internal 30 k Ω pull-down resistor that pulls this pin low and is only 1.79 V tolerant. If applications require that SDIO be driven from a 3.3 V logic level, insert a 1 k Ω resistor in series with this pin to limit the current.

SCLK Pin

The SCLK pin is required to operate the SPI port interface. It has an internal 30 k Ω pull-down resistor that pulls this pin low and is only 1.8 V tolerant. To drive the SCLK pin from a 3.3 V logic level, insert a 1 k Ω resistor in series with this pin to limit the current.

CSB Pin

The CSB pin is required to operate the SPI port interface. CSB has an internal 70 k Ω pull-up resistor that pulls this pin high and is only 1.8 V tolerant. To drive the CSB pin from a 3.3 V logic level, insert a 1 k Ω resistor in series with this pin to limit the current.

RBIAS Pin

To set the internal core bias current of the ADC, place a resistor nominally equal to 10.0 k Ω to ground at the RBIAS pin. Using a resistor other than the recommended 10.0 k Ω resistor for RBIAS degrades the performance of the device. Therefore, it is imperative that at least a 1% tolerance on this resistor be used to achieve consistent performance.

VREF Pin

A stable and accurate 0.5 V voltage reference is built in to the AD9670. This reference is gained up internally by a factor of 2, setting VREF to 1.0 V, which results in a full-scale differential input span of 2.0 V p-p for the ADC. VREF is set internally by default, but the VREF pin can be driven externally with a 1.0 V reference to achieve more accuracy. However, the AD9670 does not support ADC full-scale ranges below 2.0 V p-p.

When applying the decoupling capacitors to the VREF pin, use ceramic, low ESR capacitors. Place these capacitors close to the reference pin and on the same layer of the PCB as the AD9670. It is recommended that the VREF pin have both a 0.1 μ F capacitor and a 1 μ F capacitor that are connected in parallel to the analog ground. These capacitor values are recommended for the ADC to properly settle and acquire the next valid sample.

General-Purpose Output Pins

The general-purpose output pins, GPO0, GPO1, GPO2, and GPO3, can be used in a system to provide programmable inputs to other chips in the system. The value of each pin is set via SPI Register 0x00E to either Logic 0 or Logic 1 (see Table 27).

Chip Address Pins

The chip address pins can be used to SPI address individual AD9670 devices in a system. When chip address mode is enabled in Register 0x115, Bit 5 (see Table 27), if the value written to Bits[4:0] matches the value on the chip address bit pins (ADDR0 to ADDR4), the device is selected and any subsequent SPI writes or reads to registers indicated as chip registers are written only to that device. If chip address mode is disabled, all registers can be written to, regardless of the value on the address pins.

ANALOG TEST SIGNAL GENERATION

The AD9670 generates analog test signals that can be switched to the input of the LNA of each channel to be used for channel gain calibration. The test signal amplitude at the LNA output is dependent on LNA gain, as shown in Table 17.

Table 17. Test Signal Fundamental Amplitude at the LNA Output

| Reg. 0x116, Bits[3:2], Analog Test Tones | LNA Gain | | |
|--|---------------------|---------------------|---------------------|
| | At 15.6 dB (mV p-p) | At 17.9 dB (mV p-p) | At 21.6 dB (mV p-p) |
| 00 (Default) | 80 | 98 | 119 |
| 01 | 160 | 196 | 238 |
| 10 | 320 | 391 | 476 |

Calculate the test signal amplitude at the input to the ADC given the LNA gain, attenuator control voltage, and the PGA gain. Table 18 and Table 19 show example calculations.

Table 18. Test Signal Fundamental Amplitude at the ADC Input, $V_{GAIN} = 0$ V, PGA Gain = 21 dB

| Register 0x116, Bits[3:2], Analog Test Tones | LNA Gain | | |
|--|-------------------|-------------------|-------------------|
| | At 15.6 dB (dBFS) | At 17.9 dB (dBFS) | At 21.6 dB (dBFS) |
| 00 (Default) | -29 | -28 | -26 |
| 01 | -23 | -22 | -20 |
| 10 | -17 | -16 | -14 |

Table 19. Test Signal Fundamental Amplitude at the ADC Input, $V_{GAIN} = 0$ V, PGA Gain = 30 dB

| Register 0x116, Bits[1:0], Analog Test Tones | LNA Gain | | |
|--|-------------------|-------------------|-------------------|
| | At 15.6 dB (dBFS) | At 17.9 dB (dBFS) | At 21.6 dB (dBFS) |
| 00 (Default) | -20 | -19 | -17 |
| 01 | -14 | -13 | -11 |
| 10 | -8 | -7 | -5 |

CW DOPPLER OPERATION

Each channel of the AD9670 includes a I/Q demodulator. Each demodulator has an individual programmable phase shifter. The I/Q demodulator is ideal for phased array beamforming applications used in medical ultrasound. Each channel can be programmed for 16 delay states/360° (or 22.5°/step), selectable via the SPI port. The device has a RESET± input that synchronizes the LO dividers of each channel. If multiple AD9670 devices are used, a common reset across the array ensures a synchronized phase for all channels. Internal to the AD9670, the individual Channel I and Channel Q outputs are current summed. If multiple AD9670 devices are used, the I and Q outputs from each AD9670 can be current summed and converted to a voltage using an external transimpedance amplifier.

Quadrature Generation

The internal 0° and 90° LO phases are digitally generated by a divide-by-M logic circuit, where M = 4, 8, or 16. The internal divider is selected via SPI Register 0x02E, Bits[2:0] (see Table 27). The divider is dc-coupled and inherently broadband; the maximum LO frequency is limited only by its switching speed. The duty cycle of the quadrature LO signals must be as close to 50% as possible for the 4LO and 8LO modes. The 16LO mode does not require a 50% duty cycle. Furthermore, the divider is implemented such that the MLO signal reclocks the final flip-flops that generate the internal LO signals and, thereby, minimizes noise introduced by the divide circuitry.

For optimum performance, the MLO input is driven differentially, as on the AD9670 evaluation board. The common-mode voltage on each pin is approximately 1.5 V with the nominal 3 V supply. It is important to ensure that the MLO source has very low phase noise (jitter), a fast slew rate, and an adequate input level to obtain optimum performance of the CW signal chain.

Beamforming applications require a precise channel to channel phase relationship for coherence among multiple channels. A RESET± input is provided to synchronize the LO divider circuits in different AD9670 devices when they are used in arrays. The RESET± input is a synchronous edge triggered input that resets the dividers to a known state after power is applied to multiple AD9670 devices. The RESET± signal can be either a continuous signal or a single pulse, and it can be either synchronized with the MLO± clock edge (recommended) or it can be asynchronous. If a continuous signal is used for the RESET± signal, it must be at the LO rate. For a synchronous RESET±, the device can be configured to sample the RESET± signal with either the falling or rising edge of the MLO± clock, which makes it easier to align the RESET± signal with the opposite MLO± clock edge. Use Register 0x02E to configure the RESET signal behavior. Synchronize the RESET± input to the MLO input. Accurate channel-to-channel phase matching can be achieved via a common clock on the RESET± input when using more than one AD9670.

I/Q Demodulator and Phase Shifter

The I/Q demodulators consist of double-balanced, harmonic rejection, passive mixers. The RF input signals are converted into currents by transconductance stages that have a maximum differential input signal capability matching the LNA output full scale. These currents are then presented to the mixers, which convert them to baseband (RF – LO) and 2× RF (RF + LO).

The signals are phase shifted according to the codes programmed into the SPI latch (see Table 27). The phase shift function is an integral part of the overall circuit. The phase shift listed in Table 20 is defined as being between the baseband I or Q channel outputs. As an example, for a common signal applied to a pair of RF inputs to an AD9670, the baseband outputs are in phase for matching phase codes. However, if the phase code for Channel 1 is 0000 and that of Channel 2 is 0001, Channel 2 leads Channel 1 by 22.5°.

Table 20. Phase Select Code for Channel-to-Channel Phase Shift

| Φ Shift | I/Q Demodulator Phase (SPI Register 0x02D, Bits[3:0]) |
|----------------|--|
| 0° | 0000 |
| 22.5° | 0001 (not valid in 4LO mode) |
| 45° | 0010 |
| 67.5° | 0011 (not valid in 4LO mode) |
| 90° | 0100 |
| 112.5° | 0101 (not valid in 4LO mode) |
| 135° | 0110 |
| 157.5° | 0111 (not valid in 4LO mode) |
| 180° | 1000 |
| 202.5° | 1001 (not valid in 4LO mode) |
| 225° | 1010 |
| 247.5° | 1011 (not valid in 4LO mode) |
| 270° | 1100 |
| 292.5° | 1101 (not valid in 4LO mode) |
| 315° | 1110 |
| 337.5° | 1111 (not valid in 4LO mode) |

DIGITAL DEMODULATOR/DECIMATOR

The AD9670 contains digital processing capability. Each channel has three stages of processing available: the RF decimator, the baseband demodulator, and the baseband decimator. For test purposes, the input to the demodulator/decimator can be a test waveform. Normally, this input is the output of the ADC. The output of the demodulator/decimator is sent to the framer/serializer for output formatting.

The maximum data rate of the baseband demodulator and decimator is 65 MSPS. Therefore, if the sample of the ADC is greater than 65 MSPS, the RF decimator (with a fixed rate of 2) must be enabled. The ADC resolution is 14 bits. The maximum resolution at the output of the digital processing is 16 bits. Saturation of the ADC is determined after the dc offset calibration to ensure maximum dynamic range. Depending on the decimation rate, the loss in output SNR due to truncation to 16 bits is negligible.

VECTOR PROFILE

To minimize time needed to reconfigure device settings during operation, the device supports configuration profiles. Up to 32 profiles can be stored in the device. A profile is selected by a 5-bit index. A profile consists of a 64-bit vector, as described in Table 21. Each parameter is concatenated to form the 64-bit profile vector. The profile memory starts at Register 0xF00 and ends at Register 0xFFFF. The memory can be written in either stream or address selected data mode. However, the memory

must be read using stream mode. When writing or reading in stream mode while the SPI configuration is set to MSB first mode (the default setting for Register 0x000), the write/read address must refer to the last register address, not the first. For example, when writing or reading the first profile that spans the address space between Register 0xF00 and Register 0xF07, with the SPI port configured as MSB first, the referenced address must be Register 0xF07 to allow reading or writing the 64 profile bits in MSB mode. For more information, see the [AN-877 Application Note, Interfacing to High Speed ADCs via SPI](#).

A buffer stores the current profile data. When the profile index is written in Register 0x10C, the selected profile is read from memory and stored in the current profile buffer. The profile memory is read/written in the SPI clock domain. After the SPI writes the profile index value, the SPI takes 4 SPI clock cycles to read the profile from RAM and store it in the current profile buffer. If the SPI is in LSB mode, these additional SPI clock cycles are provided when the profile index register is written. If the SPI is in MSB mode, an additional byte must be read or written to update the profile buffer.

Updating the profile memory does not affect the data in the profile buffer. The profile index register must be written to cause a refresh of the current profile data, even if the profile index register is written with the same value.

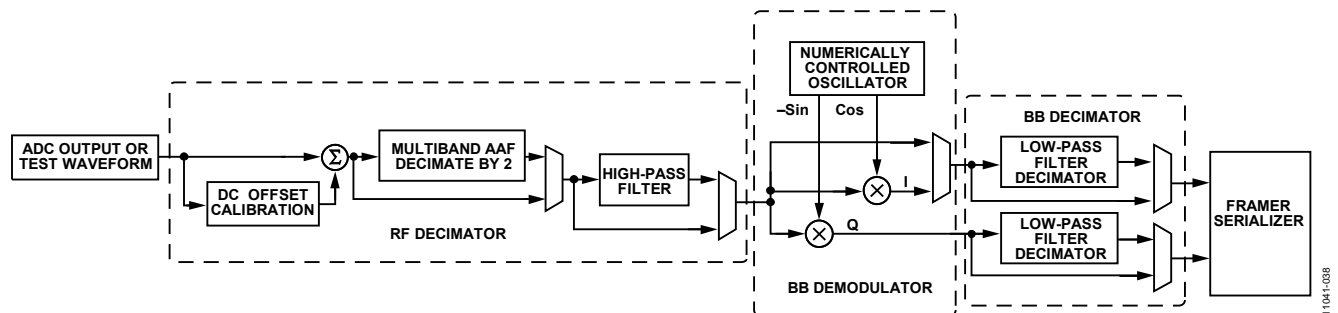

Figure 49. Simplified Block Diagram of a Single Channel of the Demodulator/Decimator

Table 21. Profile Definition

| Field | Bits | Description |
|-------|------|--|
| f | 16 | Demodulation frequency (f_D) $f_D = f \times f_{SAMPLE} / 2^{16}$, where $f = [0, (2^{16} - 1)]$ and f_{SAMPLE} is the effective sample rate 0x0000: $f_D = 0$ ($d_c = 1, Q = \cos(0) = 1, I = \sin(0) = 0$) 0x0001: $f_D = f_{SAMPLE} / 2^{16}$... 0x8000: $f_D = f_{SAMPLE} / 2$... 0xFFFF ($2^{16} - 1$): $f_D = f_{SAMPLE} (2^{16} - 1) / 2^{16} = -f_{SAMPLE} / 2^{16}$ |
| P | 8 | Pointer to coefficient block; the coefficients used begin at coefficient $P \times 8$ and continue for $M \times 8$ coefficients, for example, 0000 0000: points to coefficient 0 and continues $M \times 8$ coefficients 0000 0001: points to coefficient 8 and continues $M \times 8$ coefficients |

| Field | Bits | Description |
|-------------|------|---|
| M | 5 | Decimation factor M = N - 1, where N = decimation factor 0x00: decimate by 1 (no decimation, filtering only) 0x01: decimate by 2 0x02: decimate by 3 ... 0x1F: decimate by 32 |
| g | 3 | Digital gain compensation Gain = 2 000: gain = 1 (no shift) 001: gain = 2 (shift by 1) 010: gain = 4 (shift by 2) ... 111: gain = 128 (shift by 7) |
| HPF Bypass | 1 | Digital high-pass filter (HPF) bypass 0 = disable (filter enabled) 1 = enable (filter bypassed) |
| POWER_START | 15 | ADC clock counted from TX_TRIG ¹ signal assertion when the active channels are powered up |
| Reserved | 1 | Reserved |
| POWER_STOP | 15 | ADC clock counted from TX_TRIG ¹ signal assertion when the active channels are powered down |

¹ TX_TRIG indicates the differential signal created via the TX_TRIG- pin and the TX_TRIG+ pin.

RF DECIMATOR

The input to the RF decimator is either the ADC output data or a test waveform described in the Digital Test Waveforms section. The test waveforms are enabled per channel in Register 0x11A (see Table 27).

DC Offset Calibration

Reduce dc offset through a manual system calibration process. Measure the dc offset of every channel in the system and then set a calibration value in Register 0x110 and Register 0x111. Note that these registers are both chip and local registers, meaning that they are accessed using the chip address and device index. Bypass the dc offset calibration in Register 0x10F, Bits[2:0].

Multiband Antialiasing Filter and Decimate by 2

The multiband filter is a finite pulse response (FIR). It is programmable with low or high band filtering. The filter requires 11 input samples to populate. The decimation rate is fixed at 2x. Therefore, the decimation frequency is $f_{DEC} = f_{SAMPLE}/2$. Figure 50 and Figure 51 show the frequency response of the filter, depending on the mode. Figure 50 shows the attenuation amplitude over the Nyquist frequency range. Figure 51 shows the pass band response as nearly flat.

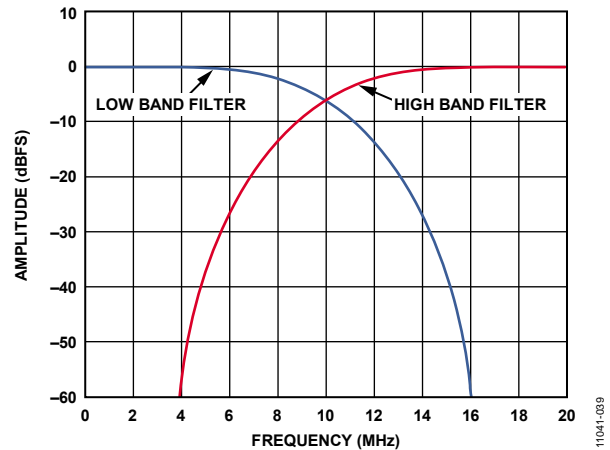

Figure 50. Antialiasing Filter Frequency Response (Frequency Scale Assumes $f_{ADC} = 2 \times f_{DEC} = 40$ MHz)

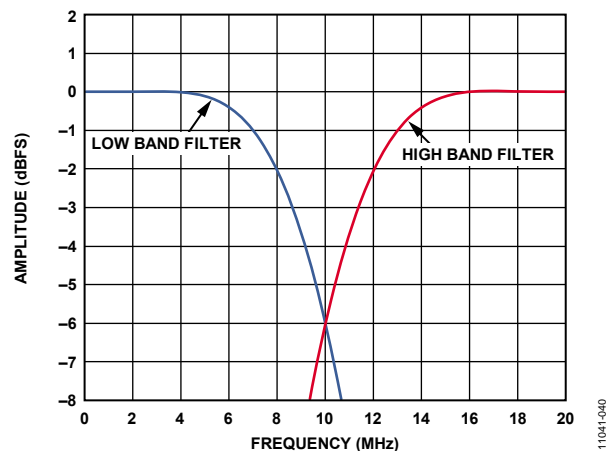

Figure 51. Antialiasing Filter Frequency Response (Frequency Scale Assumes $f_{ADC} = 2 \times f_{DEC} = 40$ MHz)

High-Pass Filter

A second-order Butterworth, high-pass infinite impulse response (IIR) filter can be applied after the RF decimator. The filter has a settling time of 2.5 μ s and a cutoff of 700 kHz for an encode clock of 50 MHz. Therefore, if the ADC clock is 50 MHz, the first 125 samples (2.5 μ s/0.02 μ s) must be ignored. The filter can be bypassed or enabled in the vector profile if the filter is enabled in Register 0x113, Bit 5. If the filter is bypassed by setting Register 0x113, Bits[5:1], the filter cannot be enabled from the vector profile.

BASEBAND DEMODULATOR AND DECIMATOR

The demodulator downconverts the RF signal to a baseband quadrature signal. The decimator reduces the excess oversampling.

Numerically Controlled Oscillator

The numerically controlled oscillator (NCO) generates I and Q signals (cos and $-\sin$) for the demodulator. A division of the effective sample clock generates the oscillator frequency. If the RF decimator is bypassed, the effective sample clock is the same as the ADC clock. If the RF decimator is enabled, the effective clock rate is $\frac{1}{2}$ the ADC sample clock frequency. The divider is set in the vector profile. The oscillator has a frequency resolution of 1 kHz. To synchronize different devices, the NCO is reset upon assertion of the TX_TRIG signal.

Decimation Filter

The purpose of the decimation filter is to band limit the demodulated signal prior to decimation. The filter is a polyphase FIR filter that uses 16 taps per decimation with symmetrical coefficients. Therefore, there are eight unique, 14-bit coefficients per decimation. The decimation rate and a pointer to the coefficients used by the filter are set in the vector profile. Digital gain from 1 to 128 is applied to the filter response. The digital gain compensation is set in the vector profile.

The filter is reset upon assertion of the TX_TRIG signal. The decimation filter takes 32 \times the decimation input samples or 32 output samples to populate.

Coefficient Memory

The coefficient memory stores the eight coefficients per decimation, with a maximum decimation of 32, in a coefficient memory block. At a maximum decimation of 32, 32 \times 8 = 256 coefficients are needed. The coefficient memory is available at Address 0x1000 to Address 0x1FFF. This is sufficient space to store up to 2048 coefficients. Each vector profile has a pointer, P, to the coefficient block within coefficient memory.

Coefficients are written using the SPI in stream mode during startup. Coefficients are written in 14-bit \times 8-word = 112-bit blocks. There are 256 coefficient blocks. The 14-bit \times 8-word coefficients are packed into 14 bytes \times 8 bits, as shown in Table 22.

Table 22. Coefficient Memory for M = 4

| j i | 7 | 6 | 5 | 4 | 3 | 2 | 1 | 0 |
|-----|----|----|----|----|----|----|---|---|
| 0 | 28 | 27 | 20 | 19 | 12 | 11 | 4 | 3 |
| 1 | 29 | 26 | 21 | 18 | 13 | 10 | 5 | 2 |
| 2 | 30 | 25 | 22 | 17 | 14 | 9 | 6 | 1 |
| 3 | 31 | 24 | 23 | 16 | 15 | 8 | 7 | 0 |

Writes and reads from a coefficient block must begin on a coefficient block boundary, and an entire coefficient block must be written or read. After a coefficient block is written, the coefficient block address automatically increments/decrements (depending on the LSB/MSB SPI setting in Register 0x000) to the next coefficient block.

Having a direct map between the SPI memory address and coefficient block address requires a divide by 7, which is not simple to do in hardware (the address must be mapped within a single cycle). Therefore, each block is padded to a 16-byte boundary, but the SPI does not need to shift in these extra 2 bytes when loading coefficient memory sequentially. If the SPI is configured LSB first, the SPI address bits, Bits[3:0], are all 0s. If the SPI is configured MSB first, the SPI address bits are all 1s. In other words, in LSB mode, the referenced addresses for the coefficient memory blocks are 0x1000, 0x2000, and so on, while in MSB SPI mode, the referenced block addresses are 0x100F, 0x200F, and so on.

The coefficient block order and how words/bytes are split across each other are shown in Table 23. When the SPI is configured LSB first, C0[0] = B0[0] is written first, and C7[13] = B13[7] is written last. When the SPI is configured MSB first, C7[13] = B13[7] is written first, and C0[0] = B0[0] is written last.

The position of a coefficient, C_n, in memory is determined from its index (i, j) by

$$n = M(1 + i) - (1 + j), \text{ if } i \text{ is even} \quad (8)$$

$$n = M \times i + j, \text{ if } i \text{ is odd} \quad (9)$$

where:

M is the decimation factor.

i is the index within the coefficient block from 0 to 7.

j is the decimation phase from 0 to *M* - 1.

Due to symmetry, Coefficient C0 is multiplied by the newest and oldest samples.

As an example, the coefficient memory for a decimation factor of *M* = 4 is shown in Table 22.

The upper 16 bits of the filter output are used as the data output of the channel. The filter output may have gain applied according to *g*, from the vector profile. Additionally, a gain of 4 \times can be applied using the filter output gain in Register 0x113, Bit 4.

Table 23. Coefficient Block Mapping into SPI Memory Location

| Coefficients (8 Words × 14 Bits) | | | | | | | | | | | | | |
|----------------------------------|----------|----------|----------|----------|----------|----------|----------|---------|---------|---------|---------|---------|---------|
| C7[13:0] | C6[13:0] | C5[13:0] | C4[13:0] | C3[13:0] | C2[13:0] | C1[13:0] | C0[13:0] | | | | | | |
| 111:98 | 97:84 | 83:70 | 69:56 | 55:42 | 41:28 | 27:14 | 13:0 | | | | | | |
| SPI Memory (14 Bytes) | | | | | | | | | | | | | |
| B13[7:0] | B12[7:0] | B11[7:0] | B10[7:0] | B9[7:0] | B8[7:0] | B7[7:0] | B6[7:0] | B5[7:0] | B4[7:0] | B3[7:0] | B2[7:0] | B1[7:0] | B0[7:0] |
| 111:104 | 103:96 | 95:88 | 87:80 | 79:72 | 71:64 | 63:56 | 55:48 | 47:40 | 39:32 | 31:24 | 23:16 | 15:8 | 7:0 |

DIGITAL TEST WAVEFORMS

Digital test waveforms can be used in the digital processing block instead of the ADC output. The digital test waveforms enable is set in Register 0x11B. Each channel can be individually enabled in Register 0x11A.

Waveform Generator

For testing and debugging, use the programmable waveform generator instead of ADC data. The waveform generator varies offset, amplitude, and frequency. The generator uses the ADC sample frequency, f_{SAMPLE} , and ADC full-scale amplitude, $A_{FULL\ SCALE}$, as references. The values are set in Register 0x117, Register 0x118, and Register 0x119 (see Table 27).

$$x = C + A \times \sin(2 \times \pi \times N) \quad (10)$$

$$N = \frac{f_{SAMPLE} \times n}{64} \quad (\text{see Register 0x117}) \quad (11)$$

$$A = \frac{A_{FULL\ SCALE}}{2^x} \quad (\text{see Register 0x118}) \quad (12)$$

$$C = A_{FULL\ SCALE} \times a \times 2^{-(13-b)} \quad (\text{see Register 0x119}) \quad (13)$$

Channel ID and Ramp Generator

In Channel ID test mode, the output is a concatenated value. Output Data Bits[6:0] are a ramp. Output Data Bit 7 is 0 in real data mode or I channel and 1 for Q channel in complex data mode. Output Data Bits[10:8] are the channel ID such that Channel A is coded as 000 and Channel B is 001. Output Data Bits[15:11] are the chip address.

Filter Coefficients

To check the filter coefficients, the input to the decimating FIR filter must be a sequence of 1 followed by 0s. The number of zeros is the decimation rate times the number of taps (16). The output shifter outputs the LSBs of the filter.

DIGITAL BLOCK POWER SAVING SCHEME

To reduce power consumption in the digital block, the demodulator and decimation filter start in an idle state after running the chip (Register 0x008, Bits[2:0] = 000). The digital block only switches to a running state when the negative edge of the TX_TRIG pulse is detected, or with a software TX_TRIG write (Register 0x10C, Bit 5 = 1).

To put the digital block back into the idle state while the rest of the chip is still running and to save power, enact one of the following three events: raise the TX_TRIG signal high, write to the profile index (Register 0x10C, Bits[4:0]), or the power stop expires if the advanced power control feature is used. Figure 52 illustrates the digital block power saving scheme.

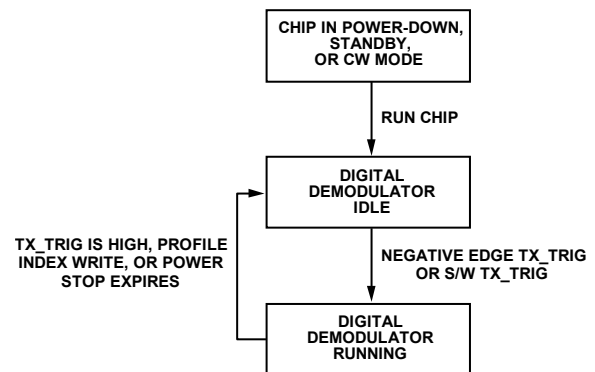

Figure 52. Digital Block Power Saving Scheme

11041-048

SERIAL PORT INTERFACE (SPI)

The AD9670 serial port interface allows the user to configure the signal chain for specific functions or operations through a structured register space provided inside the chip. The SPI offers the user added flexibility and customization, depending on the application. Addresses are accessed via the serial port and can be written to or read from via the port. Memory is organized into bytes that can be further divided into fields, as documented in the Memory Map section. For detailed operational information, see the [AN-877 Application Note, Interfacing to High Speed ADCs via SPI](#).

Three pins define the serial port interface, or SPI: SCLK, SDIO, and CSB (see Table 24). The SCLK (serial clock) pin synchronizes the read and write data presented to the device. The SDIO (serial data input/output) pin is a dual-purpose pin that allows data to be sent to and read from the internal memory map registers of the device. The CSB (chip select bar) pin is an active low control that enables or disables the read and write cycles.

Table 24. Serial Port Pins

| Pin | Function |
|------|---|
| SCLK | Serial clock. Serial shift clock input. SCLK synchronizes serial interface reads and writes. |
| SDIO | Serial data input/output. SDIO is a dual-purpose pin that typically serves as an input or an output, depending on the instruction sent and the relative position in the timing frame. |
| CSB | Chip select bar (active low). This control gates the read and write cycles. |

The falling edge of CSB, in conjunction with the rising edge of SCLK, determines the start of the framing sequence. During an instruction phase, a 16-bit instruction is transmitted, followed by one or more data bytes, which is determined by Bit Field W0 and Bit Field W1. An example of the serial timing and its definitions are shown in Figure 54 and Table 25.

During normal operation, CSB signals to the device that SPI commands are to be received and processed. When CSB is brought low, the device processes SCLK and SDIO to execute instructions. Normally, CSB remains low until the communication cycle is complete. However, if connected to a slow device, CSB can be brought high between bytes, allowing older microcontrollers enough time to transfer data into shift registers. CSB can be stalled when transferring one, two, or three bytes of data. When W0 and W1 are set to 11, the device enters streaming mode and continues to process data, either reading or writing, until CSB is taken high to end the communication cycle. This allows complete memory transfers without the need for additional instructions. Regardless of the mode, if CSB is taken high in the middle of a byte transfer, the SPI state machine is reset and the device waits for a new instruction.

In addition to the operation modes, the SPI port can be configured to operate in different manners. CSB can also be tied low to enable 2-wire mode. When CSB is tied low, SCLK and SDIO are

the only pins required for communication. Although the device is synchronized during power-up, caution must be exercised when using this mode to ensure that the serial port remains synchronized with the CSB line. When operating in 2-wire mode, it is recommended that a 1-, 2-, or 3-byte transfer be used exclusively. Without an active CSB line, streaming mode can be entered but not exited.

In addition to word length, the instruction phase determines whether the serial frame is a read or write operation, allowing the serial port to be used both to program the chip and to read the contents of the on-chip memory. If the instruction is a read-back operation, performing a readback causes the serial data input/output (SDIO) pin to change direction from an input to an output at the appropriate point in the serial frame.

Data can be sent in MSB first mode or LSB first mode. MSB first mode is the default at power-up and can be changed by adjusting the configuration register. For more information about this and other features, see the [AN-877 Application Note, Interfacing to High Speed ADCs via SPI](#).

HARDWARE INTERFACE

The pins described in Table 24 constitute the physical interface between the user programming device and the serial port of the AD9670. The SCLK and CSB pins function as inputs when using the SPI. The SDIO pin is bidirectional, functioning as an input during write phases and as an output during readback.

If multiple SDIO pins share a common connection, ensure that proper V_{OH} levels are met. Figure 53 shows the number of SDIO pins that can be connected together and the resulting V_{OH} level, assuming the same load for each AD9670.

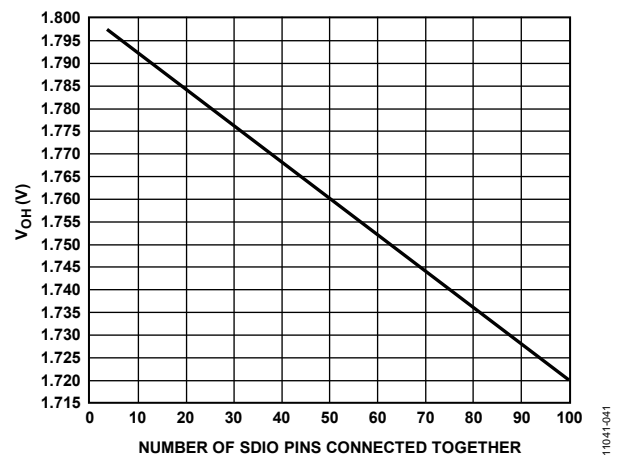

Figure 53. SDIO Pin Loading

This interface is flexible enough to be controlled either by serial PROMs or by PIC microcontrollers, which provides the user with an alternative to a full SPI controller for programming the device (see the [AN-812 Application Note, Microcontroller-Based Serial Port Interface \(SPI®\) Boot Circuit](#)).

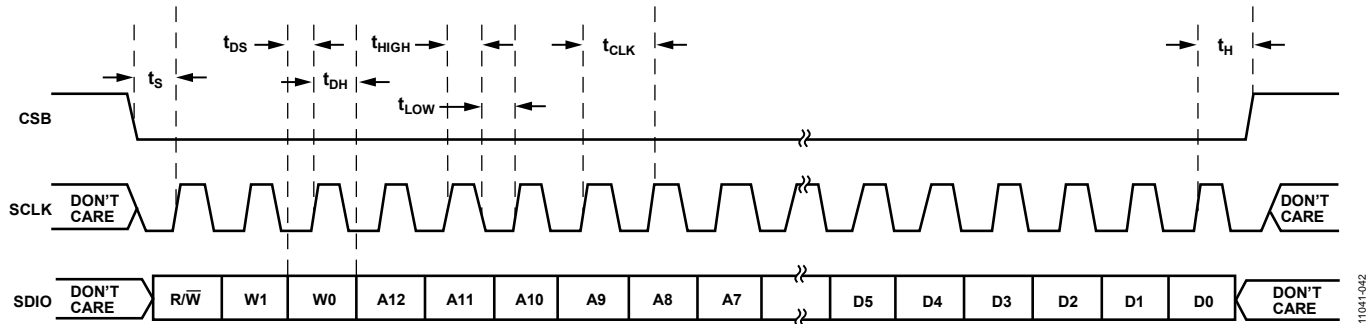

Figure 54. Serial Timing Diagram

Table 25. Serial Timing Definitions

| Parameter | Timing (ns min) | Description |
|-----------------|-----------------|---|
| t_{DS} | 12.5 | Setup time between the data and the rising edge of SCLK |
| t_{DH} | 5 | Hold time between the data and the rising edge of SCLK |
| t_{CLK} | 40 | Period of the clock |
| t_s | 5 | Setup time between CSB and SCLK |
| t_H | 2 | Hold time between CSB and SCLK |
| t_{HIGH} | 16 | Minimum period that SCLK must be in a logic high state |
| t_{LOW} | 16 | Minimum period that SCLK must be in a logic low state |
| t_{EN_SDIO} | 15 | Minimum time for the SDIO pin to switch from an input to an output relative to the SCLK falling edge (not shown in Figure 54) |
| t_{DIS_SDIO} | 15 | Minimum time for the SDIO pin to switch from an output to an input relative to the SCLK rising edge (not shown in Figure 54) |

MEMORY MAP

READING THE MEMORY MAP TABLE

Each row in the memory map register table has eight bit locations. The memory map is roughly divided into three sections: the chip configuration register map (Address 0x000 to Address 0x1A1), the profile register map (Address 0xF00 to Address 0xFFFF), and the coefficient register map (Address 0x1000 to Address 0x1FFF). Registers that are designated as local registers utilize the device index in Address 0x004 and Address 0x005 to determine to which channels of a device the command is applied. Registers that are designated as chip registers utilize the chip address mode in Address 0x115 to determine if the device is selected to be updated by writing to the chip register.

The leftmost column of the memory map indicates the register address, and the default value is shown in the second rightmost column. The Bit 7 (MSB) column is the start of the default hexadecimal value given. For example, Address 0x009, the global clock register, has a default value of 0x01, meaning that Bit 7 = 0, Bit 6 = 0, Bit 5 = 0, Bit 4 = 0, Bit 3 = 0, Bit 2 = 0, Bit 1 = 0, and Bit 0 = 1, or 0000 0001 in binary. This setting is the default for the duty cycle stabilizer in the on condition.

For more information on the SPI memory map and other functions, see the [AN-877 Application Note, Interfacing to High Speed ADCs via SPI](#).

RESERVED LOCATIONS

Undefined memory locations must not be written to except when writing the default values suggested in this data sheet. Consider addresses that have values marked as 0 reserved and write a 0 into their registers during power-up.

DEFAULT VALUES

After a reset, critical registers are automatically loaded with default values. These values are indicated in Table 27, where an X refers to an undefined feature.

LOGIC LEVELS

An explanation of various registers follows: “bit is set” is synonymous with “bit is set to Logic 1” or “writing Logic 1 for the bit.” Similarly, “bit is cleared” is synonymous with “bit is set to Logic 0” or “writing Logic 0 for the bit.”

RECOMMENDED STARTUP SEQUENCE

To save system power during programming, the [AD9670](#) powers up in power-down mode. To start up the device and initialize the data interface, the SPI commands listed in Table 26 are recommended. At a minimum, the profile memory for an index of 0 must be written (Registers 0xF00 to Register 0xF07). If additional profiles and coefficient memory are required, these can be written after Profile File Memory 0.

Table 26. SPI Write Start-Up Sequence Example

| Register | Write Value | Description |
|--|----------------|---|
| 0x000 | 0x3C | Initiates an SPI reset |
| 0x002 | 0x0X (default) | Sets the speed mode to 40 MHz |
| 0x0FF | 0x01 | Enables speed mode change (required after Register 0x002 writes) |
| 0x004 | 0x0F | Sets local registers to all channels |
| 0x005 | 0x3F | Sets local registers to all channels |
| 0x113 | 0x03 | Bypasses the demodulator and decimator; bypasses the RF decimator; enables the digital high-pass filter |
| 0x011 | 0x06 (default) | Sets LNA gain= 21.6 dB, sets VGA gain = external, and sets PGA gain = 24 dB |
| 0xF00 | 0xFF | Enables continuous run mode; do not power down channels (POWER_STOP LSB) |
| 0xF01 | 0x7F | Enables continuous run mode; do not power down channels (POWER_STOP MSB) |
| 0xF02 | 0x00 | Powers up all channels, 0 clock cycles after TX_TRIG signal assertion (POWER_START LSB) |
| 0xF03 | 0x80 | Bypasses the digital high-pass filter (POWER_START MSB) |
| 0xF04 | 0x0C | Decimates by 2 (M = 00001); digital gain = 16 (g = 100) |
| 0xF05 | 0x00 | Points to Coefficient Block 00 |
| 0xF06 | 0x00 | Demodulation frequency = $f_{\text{SAMPLE}}/8$ |
| 0xF07 | 0x20 | |
| Additional profile memory and coefficient memory can be written here | | |
| 0x10C ¹ | 0x00 (default) | Sets index profile (required after profile memory writes) |
| 0x014 | 0x00 | Sets the output data format |
| 0x008 | 0x00 | TGC run mode ² |
| 0x021 | 0x05 | 14 bits, 8 lanes, FCO covers the entire frame |
| 0x199 | 0x80 | Enables automatic clocks per sample calculation |
| 0x19B | 0x50 | Serial format |
| 0x188 | 0x01 | Enables the start code |
| 0x18B | 0x27 | Sets the start code MSB |
| 0x18C | 0x72 | Sets the start code LSB |
| 0x182 | 0x82 | Autoconfigures the PLL |
| 0x10C ³ | 0x20 | Sets SPI TX_TRIG and index profile ² |
| 0x00F | 0x18 | Sets the low-pass filter cutoff frequency, and mode |
| 0x02B | 0x40 | Sets the analog LPF and HPF to defaults, tune filters ⁴ |

¹ Setting the profile index requires an additional SPI write in SPI MSB mode before the chip is run to complete the current profile buffer update.

² Running the chip from full power-down mode requires 375 μ s wake-up time, as listed in Table 3.

³ Soft TX_TRIG switches the demodulator/decimator digital block to a running state. The soft TX_TRIG may not be needed if a hardware TX_TRIG signal is used to run the digital block.

⁴ Tuning the filters requires 512 ADC clock cycles.

Table 27. Memory Map Registers

| Addr. (Hex) | Register Name | Bit 7 (MSB) | Bit 6 | Bit 5 | Bit 4 | Bit 3 | Bit 2 | Bit 1 | Bit 0 (LSB) | Default Value | Comments |
|------------------------------|------------------|---|--|---|--|--|---|--|--|---------------|---|
| Chip Configuration Registers | | | | | | | | | | | |
| 0x000 | CHIP_PORT_CONFIG | 0 | LSB first 0 = off (default) 1 = on | SPI reset 0 = off (default) 1 = on | 1 | 1 | SPI reset 0 = off (default) 1 = on | LSB first 0 = off (default) 1 = on | 0 | 0x18 | Mirror nibbles so that LSB or MSB first mode is set correctly, regardless of shift mode. An SPI reset reverts all registers (including the LVDS registers), except Register 0x000, to their default values, and Register 0x000, Bits[2:5] are automatically cleared. |
| 0x001 | CHIP_ID | Chip ID, Bits[7:0] (AD9670 = 0xA6) (default) | | | | | | | | 0x7C | Default is unique chip ID, different for each device; read-only register. |
| 0x002 | CHIP_GRADE | X | X | Speed mode, Bits[5:4] (identify device variants of chip ID) 00: Mode I (40 MSPS) (default) 01: Mode II (65 MSPS) 10: Mode III (80 MSPS) 11: Mode III (125 MSPS) | X | X | X | X | X | 0x0X | Speed mode is used to differentiate the ADC speed power modes (the user must update Reg. 0x0FF to initiate the mode setting). |
| 0x0FF | DEVICE_UPDATE | X | X | X | X | X | X | X | X | 0x00 | A write to Reg. 0x0FF (the write value does not matter) resets all default register values (analog and ADC registers only, not LVDS registers and not Reg. 0x000 or Reg. 0x002, Bits[5:4]) if Register 0x002 has been previously written since the last reset/load of defaults. |
| 0x004 | DEVICE_INDEX_2 | X | X | X | X | Data Channel H 0 = off 1 = on (default) | Data Channel G 0 = off 1 = on (default) | Data Channel F 0 = off 1 = on (default) | Data Channel E 0 = off 1 = on (default) | 0x0F | Bits are set to determine which on-chip device receives the next write command. |
| 0x005 | DEVICE_INDEX_1 | X | X | Clock channel DCO± 0 = off 1 = on (default) | Clock channel FCO± 0 = off 1 = on (default) | Data Channel D 0 = off 1 = on (default) | Data Channel C 0 = off 1 = on (default) | Data Channel B 0 = off 1 = on (default) | Data Channel A 0 = off 1 = on (default) | 0x3F | Bits are set to determine which on-chip device receives the next write command. |
| 0x008 | GLOBAL_MODES | X | LNA input impedance 0 = 6 kΩ (default) 1 = 3 kΩ | X | 0 | 0 | Internal power-down mode 000 = chip run (TGC mode) 001 = full power-down (default) 010 = standby 011 = reset all LVDS registers 100 = CW mode (TGC power-down) | | | 0x01 | Determines the generic modes of chip operation (global). |
| 0x009 | GLOBAL_CLOCK | X | X | X | X | X | X | X | DCS 0 = off 1 = on (default) | 0x01 | Turns the internal DCS on and off (global). |
| 0x00A | PLL_STATUS | PLL lock status 0 = not locked 1 = locked | X | X | X | X | X | X | X | 0x00 | Monitors the PLL lock status (read only, global). |

| Addr. (Hex) | Register Name | Bit 7 (MSB) | Bit 6 | Bit 5 | Bit 4 | Bit 3 | Bit 2 | Bit 1 | Bit 0 (LSB) | Default Value | Comments |
|-------------|--------------------|--|-------|---|--|--|---|---|-------------|--------------------------------------|--|
| 0x00D | TEST_IO | User test mode 0 = continuous, repeat user patterns (1, 2, 3, 4, 1, 2, 3, 4...) (default) 1 = single clock cycle user patterns, then zeros (1, 2, 3, 4, 0, 0...) | X | Reset PN long generation 0 = on, PN long running (default) 1 = off, PN long held in reset | Reset PN short generation 0 = on, PN short running (default) 1 = off, PN short held in reset | | Output test mode 0000 = off (default) 0001 = midscale short 0010 = +FS short 0011 = -FS short 0100 = checkerboard output 0101 = PN sequence long 0110 = PN sequence short 0111 = one-/zero-word toggle 1000 = user input 1001:1110 = reserved 1111 = ramp output | | | 0x00 | When this register is set, the test data is placed on the output pins in place of normal data (local). |
| 0x00E | GPO | X | X | X | X | General-purpose digital outputs | | | | 0x00 | Values placed on the GPO to GPO3 pins (global). |
| 0x00F | FLEX_CHANNEL_INPUT | Filter cutoff frequency control 0 0000 = $1.45 \times (1/3) \times f_{\text{SAMPLE}}$ 0 0001 = $1.25 \times (1/3) \times f_{\text{SAMPLE}}$ 0 0010 = $1.13 \times (1/3) \times f_{\text{SAMPLE}}$ 0 0011 = $1.0 \times (1/3) \times f_{\text{SAMPLE}}$ (default) 0 0100 = $0.9 \times (1/3) \times f_{\text{SAMPLE}}$ 0 0101 = $0.8 \times (1/3) \times f_{\text{SAMPLE}}$ 0 0110 = $0.75 \times (1/3) \times f_{\text{SAMPLE}}$ 0 0111 = reserved 0 1000 = $1.45 \times (1/4.5) \times f_{\text{SAMPLE}}$ 0 1001 = $1.25 \times (1/4.5) \times f_{\text{SAMPLE}}$ 0 1010 = $1.13 \times (1/4.5) \times f_{\text{SAMPLE}}$ 0 1011 = $1.0 \times (1/4.5) \times f_{\text{SAMPLE}}$ 0 1100 = $0.9 \times (1/4.5) \times f_{\text{SAMPLE}}$ 0 1101 = $0.8 \times (1/4.5) \times f_{\text{SAMPLE}}$ 0 1110 = $0.75 \times (1/4.5) \times f_{\text{SAMPLE}}$ 0 1111 = reserved 1 0000 = $1.45 \times (1/6) \times f_{\text{SAMPLE}}$ 1 0001 = $1.25 \times (1/6) \times f_{\text{SAMPLE}}$ 1 0010 = $1.13 \times (1/6) \times f_{\text{SAMPLE}}$ 1 0011 = $1.0 \times (1/6) \times f_{\text{SAMPLE}}$ 1 0100 = $0.9 \times (1/6) \times f_{\text{SAMPLE}}$ 1 0101 = $0.8 \times (1/6) \times f_{\text{SAMPLE}}$ 1 0110 = $0.75 \times (1/6) \times f_{\text{SAMPLE}}$ 1 0111 = reserved | | | | BW mode 0 = low (default, 8 MHz to 18 MHz) 1 = high (13.5 MHz to 30 MHz) | X | X | 0x18 | Antialiasing filter cutoff (global). | |
| 0x010 | FLEX_OFFSET | X | X | 1 | 0 | 0 | 0 | 0 | 0 | 0x20 | Reserved. |
| 0x011 | FLEX_GAIN | Digital VGA gain control 0000 = GAIN± pins enabled (default) 0001 = 0.0 dB (maximum gain, GAIN± pins disabled) 0010 = -3.5 dB 0011 = -7.0 dB ... 1110 = -45.5 dB 1111 = -45.5 dB | | | | PGA gain 00 = 21 dB 01 = 24 dB (default) 10 = 27 dB 11 = 30 dB | | LNA gain 00 = 15.6 dB 01 = 17.9 dB 10 = 21.6 dB (default) 11 = low | | 0x06 | LNA and PGA gain adjustment (global). |
| 0x012 | BIAS_CURRENT | X | X | X | X | 1 | PGA bias 0 = 100% (default) 1 = 60% | LNA bias 00 = high 01 = midhigh (default) 10 = midlow 11 = low | | 0x09 | LNA bias current adjustment (global). |
| 0x013 | RESERVED_13 | 0 | 0 | 0 | 0 | 0 | 0 | 0 | 0 | 0x00 | Reserved. |
| 0x014 | OUTPUT_MODE | X | X | X | Output data enable 0 = enable (default) 1 = disable | X | Output data invert 0 = disable (default) 1 = enable | Output data format 00 = offset binary (default) 01 = twos complement (default) 10 = gray code 11 = reserved | | 0x01 | Data output modes (local). |

| Addr. (Hex) | Register Name | Bit 7 (MSB) | Bit 6 | Bit 5 | Bit 4 | Bit 3 | Bit 2 | Bit 1 | Bit 0 (LSB) | Default Value | Comments |
|-------------|-------------------|--|--|---|---|---|--|---|---|---------------|---|
| 0x015 | OUTPUT_ADJUST | LVDS output standard 0 = ANSI (default) 1 = IEEE (low power) | 1 | 1 | 0 | LVDS drive strength enable 0 = disable (default) 1 = enable | LVDS drive current 000 = 3.72 mA 001 = 3.5 mA (default) 010 = 3.30 mA 011 = 2.96 mA 100 = 2.82 mA 101 = 2.57 mA 110 = 2.27 mA 111 = 2.0 mA (reduced range) | | | 0x61 | Data output levels (global). |
| 0x016 | FLEX_OUTPUT_PHASE | X | X | 0 | DCO invert 0 = disable (default) 1 = enable | X | X | DCO phase adjust with respect to DOUT 00 = +90° (default) 01 = 0° 10 = 0° 11 = -90° | | 0x00 | DCO inversion and course phase adjustment (global). |
| 0x017 | FLEX_OUTPUT_DELAY | DCO delay enable 0 = disable (default) 1 = enable | X | X | DCO clock delay 00000: 100 ps (default) 00001 = 200 ps 00010 = 300 ps ... 11101 = 3.0 ns 11110 = 3.1 ns 11111 = 3.2 ns | | | | | 0x00 | DCO delay (global). |
| 0x018 | FLEX_VREF | X | X | X | X | X | 1 | 0 | 0 | 0x04 | Reserved (global). |
| 0x019 | USER_PATT1_LSB | B7 | B6 | B5 | B4 | B3 | B2 | B1 | B0 | 0x00 | User Defined Pattern 1, LSB (global). |
| 0x01A | USER_PATT1_MSB | B15 | B14 | B13 | B12 | B11 | B10 | B9 | B8 | 0x00 | User Defined Pattern 1, MSB (global). |
| 0x01B | USER_PATT2_LSB | B7 | B6 | B5 | B4 | B3 | B2 | B1 | B0 | 0x00 | User Defined Pattern 2, LSB (global). |
| 0x01C | USER_PATT2_MSB | B15 | B14 | B13 | B12 | B11 | B10 | B9 | B8 | 0x00 | User Defined Pattern 2, MSB (global). |
| 0x01D | USER_PATT3_LSB | B7 | B6 | B5 | B4 | B3 | B2 | B1 | B0 | 0x00 | User Defined Pattern 3, LSB (global). |
| 0x01E | USER_PATT3_MSB | B15 | B14 | B13 | B12 | B11 | B10 | B9 | B8 | 0x00 | User Defined Pattern 3, MSB (global). |
| 0x01F | USER_PATT4_LSB | B7 | B6 | B5 | B4 | B3 | B2 | B1 | B0 | 0x00 | User Defined Pattern 4, LSB (global). |
| 0x020 | USER_PATT4_MSB | B15 | B14 | B13 | B12 | B11 | B10 | B9 | B8 | 0x00 | User Defined Pattern 4, MSB (global). |
| 0x021 | FLEX_SERIAL_CTRL | 0 | FCO invert 0 = not inverted (default) 1 = inverted | Lane mode 00 = 1 channel/lane (8 lanes) (default) 01 = 2 channels/lane (4 lanes) 10 = 4 channels/lane (2 lanes) 11 = 8 channels/lane (1 lane) | | Lane low rate 0 = normal (default) 1 = low sample frequency (<32 MHz) | FCO rate with demodulator enabled 0 = FCO per I/Q (default) 1 = FCO per sample (I and Q) | Output word length 00 = 12 bits (default) 01 = 14 bits 10 = 16 bits 11 = reserved | | 0x00 | LVDS control (global). |
| 0x022 | SERIAL_CH_STAT | X | X | X | X | X | X | X | Channel power-down 1 = on 0 = off (default) | 0x00 | Used to power down individual channels (local). |

| Addr. (Hex) | Register Name | Bit 7 (MSB) | Bit 6 | Bit 5 | Bit 4 | Bit 3 | Bit 2 | Bit 1 | Bit 0 (LSB) | Default Value | Comments |
|-------------|-----------------|--|--|---|--|---|---|---|-------------|---|-----------|
| 0x02B | FLEX_FILTER | X | Enable automatic low-pass tuning 1 = on (self clearing) | X | X | Bypass analog HPF 0 = off (default) 1 = on | X | Analog high-pass filter cutoff 00 = $f_{LP}/12.00$ (default) 01 = $f_{LP}/9.00$ 10 = $f_{LP}/6.00$ 11 = $f_{LP}/3.00$ | 0x00 | Filter cutoff (global); (f_{LP} = low-pass filter cutoff frequency). | |
| 0x02C | LNA_TERM | X | X | X | X | X | X | LO-x, LOSW-x connection 00 = R_{FB1} (default) 01 = $(R_{FB1} \parallel R_{FB2})$ 10 = R_{FB2} 11 = ∞ | 0x00 | LNA active termination/input impedance (global). | |
| 0x02D | CW_ENABLE_PHASE | X | X | X | CW Doppler channel enable 0 = off (default) 1 = on | I/Q demodulator phase 0000 = 0° (default) 0001 = 22.5° (not valid for 4LO mode) 0010 = 45° 0011 = 67.5° (not valid for 4LO mode) 0100 = 90° 0101 = 112.5° (not valid for 4LO mode) 0110 = 135° 0111 = 157.5° (not valid for 4LO mode) 1000 = 180° 1001 = 202.5° (not valid for 4LO mode) 1010 = 225° 1011 = 247.5° (not valid for 4LO mode) 1100 = 270° 1101 = 292.5° (not valid for 4LO mode) 1110 = 315° 1111 = 337.5° (not valid for 4LO mode) | | | 0x00 | Phase of demodulators (local, chip). | |
| 0x02E | CW_LO_MODE | Partially enables LVDS during CW 0: LVDS link disabled during CW (default) 1: LVDS link partially enabled during CW. PLL, FCO, and DCO are enabled, while LVDS data drivers are disabled (switching activity can degrade CW performance) | RESET with MLO clock edge 0 = synchronous (default) 1 = asynchronous | Synchronous RESET sampling MLO± clock edge 0 = falling (default) 1 = rising | RESET signal polarity 0 = active high (default) 1 = active low | MLO and RESET buffer enable (in all modes except CW mode) 0 = power-down (default) 1 = enable | LO mode 00X = 4LO, 3 rd to 5 th odd harmonic rejection (default) 010 = 8LO, 3 rd to 5 th odd harmonic rejection 011 = 8LO, 3 rd to 13 th odd harmonic rejection 100 = 16LO, 3 rd to 5 th odd harmonic rejection 101 = 16LO, 3 rd to 13 th odd harmonic rejection 11X = reserved | | 0x00 | CW mode functions (global). | |
| 0x02F | CW_OUTPUT | CW output dc bias voltage 0 = bypass 1 = enable (default) | 0 | 0 | 0 | 0 | 0 | 0 | 0 | 0x80 | Global. |
| 0x102 | RESERVED_102 | 0 | 0 | 0 | 0 | 0 | 0 | 0 | 0 | 0X00 | Reserved. |
| 0x103 | RESERVED_103 | 0 | 0 | 0 | 0 | 0 | 0 | 0 | 0 | 0X00 | Reserved. |
| 0x104 | RESERVED_104 | 0 | 0 | 1 | 1 | 1 | 1 | 1 | 1 | 0x3F | Reserved. |
| 0x105 | RESERVED_105 | 0 | 0 | 0 | 0 | 0 | 0 | 0 | 0 | 0x00 | Reserved. |
| 0x106 | RESERVED_106 | 0 | 0 | 0 | 0 | 0 | 0 | 0 | 0 | 0x00 | Reserved. |
| 0x107 | RESERVED_107 | 0 | 0 | 0 | 0 | 0 | 0 | X | X | Read only | Reserved. |
| 0x108 | RESERVED_108 | 0 | 0 | 0 | 0 | 0 | 0 | 0 | 0 | 0x00 | Reserved. |

| Addr. (Hex) | Register Name | Bit 7 (MSB) | Bit 6 | Bit 5 | Bit 4 | Bit 3 | Bit 2 | Bit 1 | Bit 0 (LSB) | Default Value | Comments |
|-------------|-------------------|--|-------|---|--|---|--|--|---|---------------|--|
| 0x109 | VGA_TEST | X | X | X | VGA/ anti-aliasing filter test mode enable 0 = off (default) 1 = on | X | VGA/ anti-aliasing filter output test mode 000 = Channel A (default) 001 = Channel B 010 = Channel C 011 = Channel D 100 = Channel E 101 = Channel F 110 = Channel G 111 = Channel H | | | 0x00 | VGA/ anti-aliasing filter test mode enables anti-aliasing filter output to the GPO2 and GPO3 pins (global). |
| 0x10C | PROFILE_INDEX | X | X | Manual TX_TRIG 0 = off, use pin (default) 1 = on, auto-generate TX_TRIG (self clears) | Profile Index[4:0] | | | | | 0x00 | Index for profile memory selects active profile (global). |
| 0x10D | RESERVED_10D | 1 | 1 | 1 | 1 | 1 | 1 | 1 | 1 | 0xFF | Reserved. |
| 0x10E | RESERVED_10E | 1 | 1 | 1 | 1 | 1 | 1 | 1 | 1 | 0xFF | Reserved. |
| 0x10F | DIG_OFFSET_CAL | 0 | 0 | 0 | 0 | Digital offset calibration status 0 = not complete (default) 1 = complete | Digital offset calibration 000 = disable correction, reset correction value (default) 001 = average 210 samples 010 = average 211 samples ... 111 = average 216 samples | | | | Controls digital offset calibration enable and the number of samples used (global). |
| 0x110 | DIG_OFFSET_CORR1 | D7 | D6 | D5 | D4 | D3 | D2 | D1 | D0 | 0x00 | Offset correction LSB (local, chip). |
| 0x111 | DIG_OFFSET_CORR2 | D15 | D14 | D13 | D12 | D11 | D10 | D9 | D8 | 0x00 | Offset correction MSB (local, chip). |
| | | Digital offset calibration (read back if auto calibration is enabled with Register 0x10F; otherwise, force correction value Offset correction = [D15:D0] × A _{FULL SCALE} /216 0111 1111 1111 1111 (215 - 1) = +1/2 × A _{FULL SCALE} - 1/216 × A _{FULL SCALE} 0111 1111 1111 1110 (215 - 2) = +1/2 × A _{FULL SCALE} - 2/216 × A _{FULL SCALE} ... 0000 0000 0000 0001 (+1) = 1/216 × A _{FULL SCALE} 0000 0000 0000 0000 = no correction (default) 1111 1111 1111 1111 (-1) = -1/216 × A _{FULL SCALE} ... 1000 0000 0000 0000 (-215) = -1/2 full scale | | | | | | | | | |
| 0x112 | POWER_MASK_CONFIG | X | X | X | Power up set-up time (POWER_SETUP) 0 0000 = 0 0 0001 = 1 × 40/f _{SAMPLE} 0 0010 = 2 × 40/f _{SAMPLE} (default) 0 0011 = 3 × 40/f _{SAMPLE} ... 1 1111 = 31 × 40/f _{SAMPLE} | | | | | 0x02 | Power setup time is used to set the power-up time (global). |
| 0x113 | DIG_DEMOD_CONFIG | X | X | Digital high-pass filter 0 = enable (default) 1 = bypass | Decimator gain scale 0 = no gain (default) 1 = 4× gain (shift decimator output by 2) | Decimator and filter enable 00 = RF 2× decimator bypassed (default) 01 = RF 2× decimator enabled and low band filter 1X = RF 2× decimator enabled and high band filter | | Baseband decimator 0 = enable (default) 1 = bypass | Demodulator 0 = enable (default) 1 = bypass | 0x00 | Enable stages of the digital processing (global). |
| 0x115 | CHIP_ADDR_EN | X | X | Chip address mode 0 = disable (default) 1 = enable | Chip address qualifier 0 0000 (default) (If read, returns the state of ADDR0 to ADDR4 pins) | | | | | 0x00 | Chip address mode enables the addressing of devices if the value of the chip address qualifier equals the state on the ADDR0 to ADDR4 pins (global). |

| Addr. (Hex) | Register Name | Bit 7 (MSB) | Bit 6 | Bit 5 | Bit 4 | Bit 3 | Bit 2 | Bit 1 | Bit 0 (LSB) | Default Value | Comments |
|--|----------------------|--|---|--|---|---|--|--|---|---|--|
| 0x116 | ANALOG_TEST_TONE | X | X | X | X | Analog test signal amplitude (see Table 17 to Table 19) | | Analog test signal frequency 00 = $f_{\text{SAMPLE}}/4$ (default) 01 = $f_{\text{SAMPLE}}/8$ 10 = $f_{\text{SAMPLE}}/16$ 11 = $f_{\text{SAMPLE}}/32$ | | 0x00 | Analog test tone amplitude and frequency (global). |
| 0x117 | DIG_SINE_TEST_FREQ | X | X | X | Digital test tone frequency 0 0000 = $1 \times f_{\text{SAMPLE}}/64$ 0 0001 = $2 \times f_{\text{SAMPLE}}/64$... 1 1111 = $32 \times f_{\text{SAMPLE}}/64$ | | | | | 0x00 | Digital sine test tone frequency (global). |
| 0x118 | DIG_SINE_TEST_AMP | X | X | X | X | Digital test tone amplitude 0000 = $A_{\text{FULL SCALE}}$ (default) 0001 = $A_{\text{FULL SCALE}}/2$ 0010 = $A_{\text{FULL SCALE}}/22$... 1111 = $A_{\text{FULL SCALE}}/215$ | | | | 0x00 | Digital sine test tone amplitude (global). |
| 0x119 | DIG_SINE_TEST_OFFSET | Offset multiplier (a) 0 1111 = +15 0 1110 = +14 ... 0 0000 = 0 (default) 1 1111 = -1 ... 1 0000 = -16 | | | | | Offset exponent (b) 000 = 0 (default) 001 = 1 ... 111 = 7 | | | 0x00 | Digital sine test tone offset (global). |
| $\text{Offset} = A_{\text{FULL SCALE}} \times a \times 2^{-(13-b)}$ $\text{Offset range is } \sim 0.5 \text{ dB}$ $\text{Maximum positive offset} = 15 \times 2^{-(13-7)} = +0.25 \times A_{\text{FULL SCALE}}$ $\text{Maximum negative offset} = -16 \times 2^{-(13-7)} \approx -0.25 \times A_{\text{FULL SCALE}}$ | | | | | | | | | | | |
| 0x11A | TEST_MODE_CH_ENABLE | Channel H enable 0 = off (default) 1 = on | Channel G enable 0 = off (default) 1 = on | Channel F enable 0 = off (default) 1 = on | Channel E enable 0 = off (default) 1 = on | Channel D enable 0 = off (default) 1 = on | Channel C enable 0 = off (default) 1 = on | Channel B enable 0 = off (default) 1 = on | Channel A enable 0 = off (default) 1 = on | 0x00 | Enable channels for test mode (global). |
| 0x11B | TEST_MODE_CONFIG | X | X | X | X | X | Test mode selection 000 = disable test modes (default) 001 = enable digital sine test mode 010 = enable decimator filter test (output of decimator is the sequence of filter coefficients) 011 = enable channel ID test mode 16-bit data = digital ramp (7 bits) + I/Q bit + Channel ID (3 bits) + Chip Address (5 bits) 100 = enable analog test tone 101 = reserved 110 = reserved 111 = reserved | | | 0x00 | Enable digital test modes (global). |
| 0x11C | RESERVED_11C | 0 | 0 | 0 | 0 | 0 | 0 | 0 | 0 | 0x00 | Reserved. |
| 0x11D | RESERVED_11D | 0 | 0 | 0 | 0 | 0 | 0 | 0 | 0 | 0x00 | Reserved. |
| 0x11E | RESERVED_11E | 0 | 0 | 0 | 0 | 0 | 0 | 0 | 0 | 0x00 | Reserved. |
| 0x11F | RESERVED_11F | 0 | 0 | 0 | 0 | 0 | 0 | 0 | 0 | 0x00 | Reserved. |
| 0x120 | CW_TEST_TONE | 0 | CW I/Q output swap 0 = disable (default) 1 = enable | LNA offset cancellation 0 = enable (default) 1 = disable | LNA offset cancellation transconductance 00 = 0.5 mS (default) 01 = 1.0 mS 10 = 1.5 mS 11 = 2.0 mS | CW analog test tone override for Reg. 0x116, Bits[1:0] 00 = disable override (default) 01 = set analog test tone frequency to f_{LO} 1X = set analog test tone frequency to dc | | 0 | 0x00 | Sets the frequency of the analog test tone to f_{LO} in CW Doppler mode. Enables I/Q output swap. LNA offset cancellation control (global). | |
| 0x180 | RESERVED_180 | 1 | 0 | 0 | 0 | 0 | 1 | 1 | 1 | 0x87 | Reserved. |
| 0x181 | RESERVED_181 | 0 | 0 | 0 | 0 | 0 | 0 | 0 | 0 | 0x00 | Reserved. |
| 0x182 | PLL_STARTUP | PLL auto configure 0 = disable (default) 1 = enable | 0 | 0 | 0 | 0 | 0 | 1 | 0 | 0x02 | PLL control (global). |
| 0x183 | RESERVED_183 | 0 | 0 | 0 | 0 | 0 | 1 | 1 | 1 | 0x07 | Reserved. |
| 0x184 | RESERVED_184 | 0 | 0 | 0 | 0 | 0 | 0 | 0 | 0 | 0x00 | Reserved. |
| 0x186 | RESERVED_186 | 1 | 0 | 1 | 0 | 1 | 1 | 1 | 0 | 0xAE | Reserved. |

| Addr. (Hex) | Register Name | Bit 7 (MSB) | Bit 6 | Bit 5 | Bit 4 | Bit 3 | Bit 2 | Bit 1 | Bit 0 (LSB) | Default Value | Comments |
|-------------|----------------------|--|---|--|--|--|-------|-------|--|---------------|---|
| 0x187 | RESERVED_187 | 0 | 0 | 1 | 0 | 0 | 0 | 0 | 0 | 0x20 | Reserved. |
| 0x188 | START_CODE_EN | 0 | 0 | 0 | 0 | 0 | 0 | 0 | Start code identifier 0 = disable 1 = enable (default) | 0x01 | Enables start code identifier (global). |
| 0x189 | RESERVED_189 | 0 | 0 | 0 | 0 | 0 | 0 | 0 | 0 | 0x00 | Reserved. |
| 0x18A | RESERVED_18A | 0 | 0 | 0 | 0 | 0 | 0 | 0 | 0 | 0x00 | Reserved. |
| 0x18B | START_CODE_MSB | B15 | B14 | B13 | B12 | B11 | B10 | B9 | B8 | 0x27 | Start code MSB (global). |
| 0x18C | START_CODE_LSB | B7 | B6 | B5 | B4 | B3 | B2 | B1 | B0 | 0x72 | Start code LSB (global). |
| 0x190 | RESERVED_190 | 0 | 0 | 0 | 1 | 0 | 0 | 0 | 0 | 0x10 | Reserved. |
| 0x191 | RESERVED_191 | 0 | 0 | 0 | 0 | 0 | 0 | 0 | 0 | 0x00 | Reserved. |
| 0x192 | RESERVED_192 | 0 | 0 | 0 | 1 | 1 | 0 | 0 | 0 | 0x18 | Reserved. |
| 0x193 | RESERVED_193 | 0 | 0 | 0 | 0 | 0 | 0 | 0 | 0 | 0x00 | Reserved. |
| 0x194 | RESERVED_194 | 0 | 0 | 0 | 1 | 1 | 1 | 0 | 0 | 0x1C | Reserved. |
| 0x195 | RESERVED_195 | 0 | 0 | 0 | 0 | 0 | 0 | 0 | 0 | 0x00 | Reserved. |
| 0x196 | RESERVED_196 | 0 | 0 | 0 | 1 | 1 | 0 | 0 | 0 | 0x18 | Reserved. |
| 0x197 | RESERVED_197 | 0 | 0 | 0 | 0 | 0 | 0 | 0 | 0 | 0x00 | Reserved. |
| 0x198 | CLOCK_DOUBLING | 0 | 0 | 0 | 0 | DCO frequency doubling/divider 1011 = 1/32 1010 = 1/64 1001 = 1/128 1000 = 1/256 0000 = 1 (default) 0001 = 2 0010 = 4 0011 = 8 0100 = 16 0101 = 32 0110 = 64 0111 = 128 1000 = 1/256 1001 = 1/128 1010 = 1/64 1011 = 1/32 1100 = 1/16 1101 = 1/8 1110 = 1/4 1111 = 1/2 | | | | 0x00 | DCO frequency control (global). |
| 0x199 | SAMPLE_CLOCK_COUNTER | Enable clocks per sample auto calculation 0 = off (default) 1 = on | 0 | 0 | 0 | 0 | 0 | 0 | 0 | 0x00 | Enables automatic clocks per sample calculation (global). |
| 0x19A | DATA_OUTPUT_INVERT | X | X | X | X | X | X | X | Invert data output 0 = non-inverted (default) 1 = inverted | 0x00 | Inverts DOUT outputs (global). |
| 0x19B | SERIAL_FORMAT | X | Enable FCO for start code sample 0 = disable 1 = enable (default) | Enable FCO for extra sample at end of burst 0 = disable 1 = enable (default) | Enable FCO continuously 0 = only during burst 1 = continuous (default) | FCO rotate 0000 = FCO aligned with DOUT 0001 = FCO 1 bit before DOUT 0010 = FCO 2 bits before DOUT ... 1101 = FCO 3 bits after DOUT 1110 = FCO 2 bits after DOUT 1111 = FCO 1 bit after DOUT | | | | 0x70 | FCO controls (global). |
| 0x19C | RESERVED_19C | 0 | 0 | 0 | 1 | 0 | 0 | 0 | 0 | 0x10 | Reserved. |
| 0x19D | RESERVED_19D | 0 | 0 | 0 | 0 | 0 | 0 | 0 | 0 | 0x00 | Reserved. |
| 0x19E | RESERVED_19E | 0 | 0 | 0 | 1 | 0 | 0 | 0 | 0 | 0x10 | Reserved. |
| 0x19F | RESERVED_19F | 0 | 0 | 0 | 0 | 0 | 0 | 0 | 0 | 0x00 | Reserved. |

| Addr. (Hex) | Register Name | Bit 7 (MSB) | Bit 6 | Bit 5 | Bit 4 | Bit 3 | Bit 2 | Bit 1 | Bit 0 (LSB) | Default Value | Comments |
|------------------------------|--------------------|----------------|-------|-------|-------|-------|-------|-------|-------------|---------------|-----------|
| 0x1A0 | RESERVED_1A0 | 0 | 0 | 0 | 0 | 0 | 0 | 0 | 0 | 0x00 | Reserved. |
| 0x1A1 | RESERVED_1A1 | 0 | 0 | 0 | 0 | 0 | 0 | 0 | 0 | 0x00 | Reserved. |
| Profile Memory Registers | | | | | | | | | | | |
| 0x1000 to 0x1FFF | Coefficient memory | 32 × 64 bits | | | | | | | | 0x00 | Global. |
| Coefficient Memory Registers | | | | | | | | | | | |
| 0xF00 to 0xFFF | Profile memory | 256 × 112 bits | | | | | | | | 0x00 | Global. |

MEMORY MAP REGISTER DESCRIPTIONS

For more information on the SPI memory map and other functions, consult the [AN-877 Application Note, Interfacing to High Speed ADCs via SPI](#).

Transfer (Register 0x0FF)

All registers except Register 0x002 are updated the moment they are written. Setting Bit 0 of Register 0x0FF high initializes and updates the speed mode (Address 0x002) and resets all other registers to their default values. Bit 0 is self clearing. It is recommended that Register 0x002 and Register 0x0FF, Bit 0, be set at the beginning of the setup SPI writes after the device is powered up. This avoids rewriting other registers after Register 0x0FF is set.

Profile Index and Manual TX_TRIG (Register 0x10C)

The vector profile is selected using the profile index in Register 0x10C, Bits[4:0]. The manual TX_TRIG control in Bit 5 generates a TX_TRIG signal internal to the device. This signal is asynchronous to the ADC sample clock. Therefore, it cannot be used to align the data output, advanced power mode, or NCO reset across multiple devices in the system. The external pin-driven TX_TRIG control is recommended for systems that require synchronization of these features across multiple [AD9670](#) devices.

OUTLINE DIMENSIONS

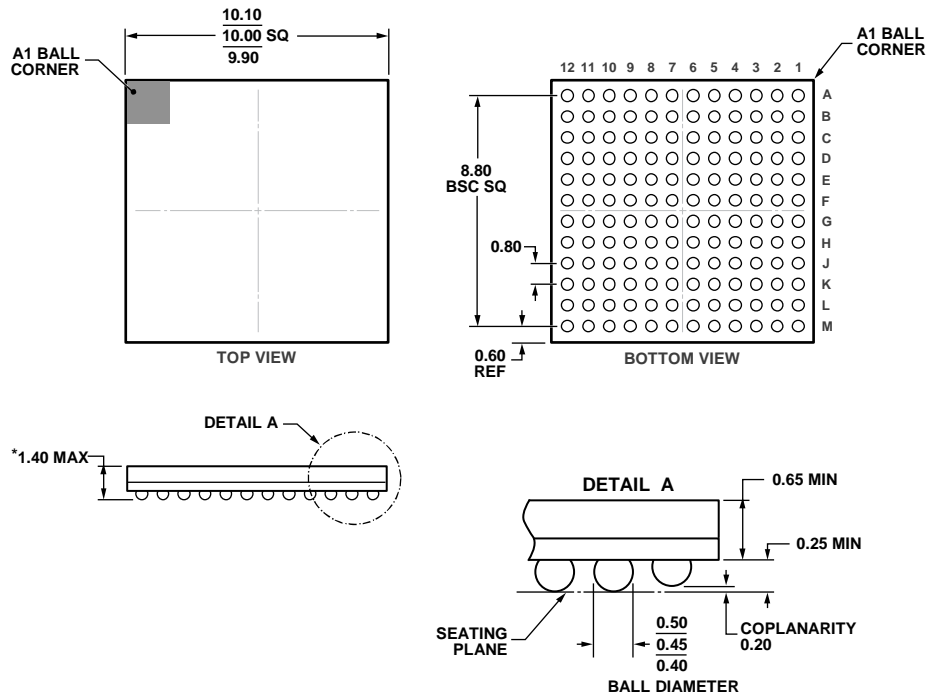

*COMPLIANT WITH JEDEC STANDARDS MO-275-EEAB-1 WITH THE EXCEPTION OF PACKAGE HEIGHT.

Figure 55. 144-Ball Chip Scale Package, Ball Grid Array [CSP_BGA] (BC-144-1)

Dimensions shown in millimeters

ORDERING GUIDE

| Model ¹ | Temperature Range | Package Description | Package Option |
|--------------------|-------------------|--|----------------|
| AD9670BBCZ | 0°C to +85°C | 144-Ball Chip Scale Package, Ball Grid Array [CSP_BGA] | BC-144-1 |
| AD9670EBZ | | Evaluation Board | |

¹ Z = RoHS Compliant Part.