



ENGLISH

Datasheet

Stock No. 1863109

RS PRO Connector Assembly

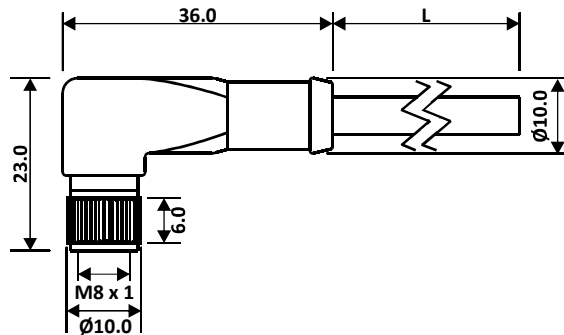

M08 Female Right Angled

All dimensions are in mm.

General Specification

Rated Operational Voltage	30 V
Current Rating	4A
Insulation Resistance	$\geq 100 \text{ M}\Omega$
Temperature Range	-25°C ... +75°C
Degree of Protection	IP67

Material Specification

Grip Material	PU
Contact	Cu-Zn
Contact Plating	Gold Plated
Contact Carrier	Nylon 66
Grip Colour	Transparent/Orange
Coupling Nut	Brass Nickel-Plated

Cable Specification

Cable Length-L	2 m
Cable Type	4 Core PVC Multi Strand
Sheath Colour	Black
Cross Section of Wire	0.25 sq. mm
Core Dia	1.25 mm
Cable Dia	$4.8 \pm 0.1 \text{ mm}$
Termination	Partially Stripped
LED Indication	Power - Green Output - Red
Output Type	PNP

Pin Assignment

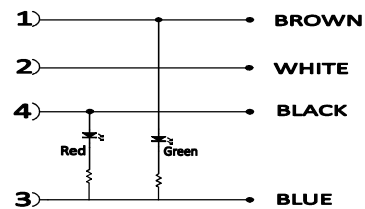
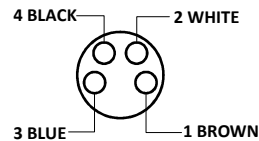

Specifications are subject to change without notice.



Type Approved
Safety
Regular Production
Surveillance

www.tuv.com
ID: 1111210482

