



ENGLISH

## Datasheet

# DC Axial Fan, 92.5 x 92.5 x 25mm, 90.1m<sup>3</sup>/h, 3W, 24 V dc (OD9225 Series)

RS Stock 619-7194

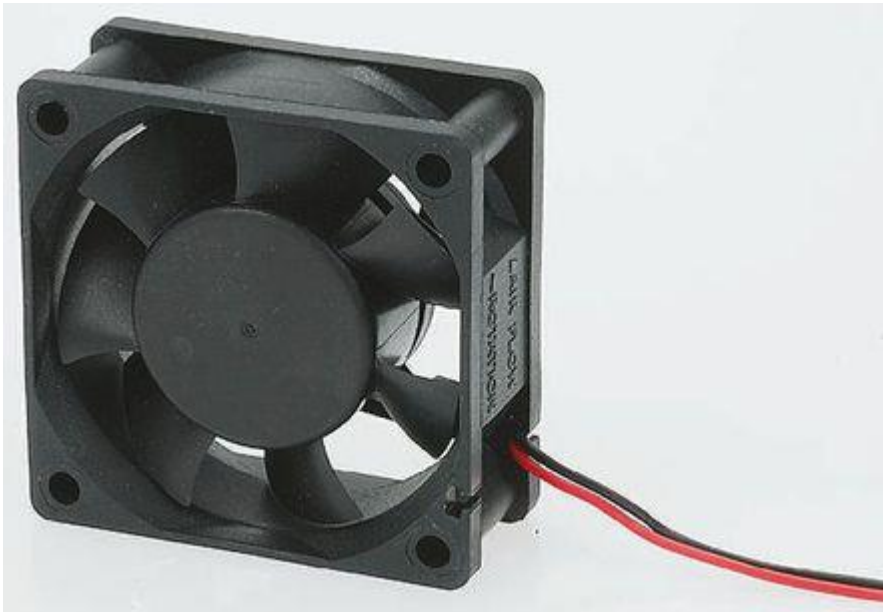

### Dimensions: (mm)

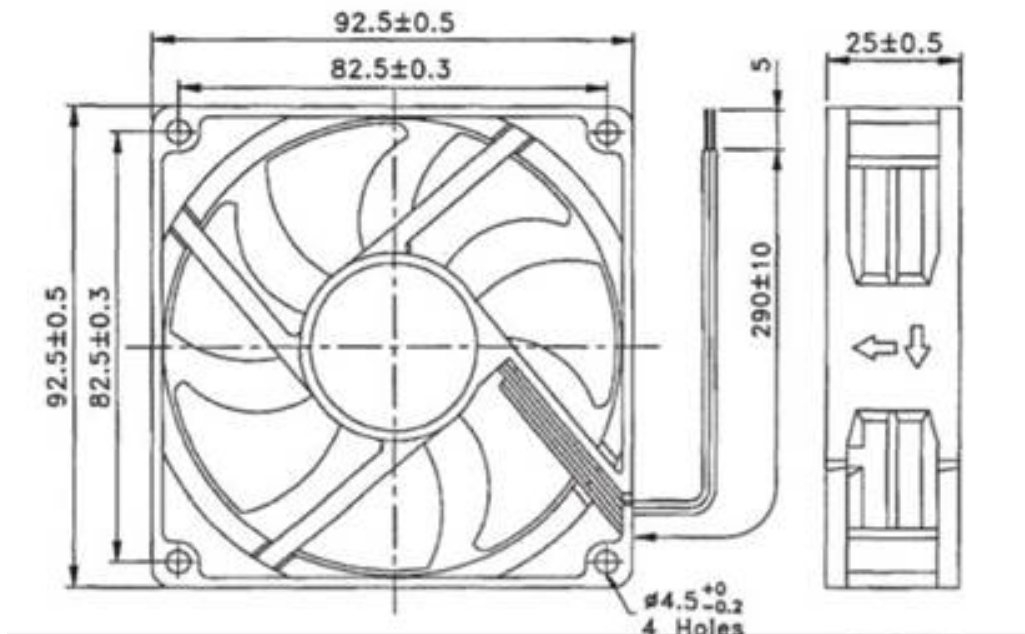



### Specifications

- Impeller & Frame: PBT , UL94V-0 Thermoplastic

### Available Options

- Tachometer
- Locked Rotor Alarm
  
- MOTOR: Brushless DC, polarity protected, locked rotor protected (current limited), auto restart
- INSULATION RESISTANCE Min. 10M ohms at 500VDCLIFE EXPECTANCY (L10) :Ball Bearing 60,000 Hours
- Operating Temperature -10C ~ +70C
- Safety Approvals: UL/CUL, TUV, CE

RS Part No.	Speed	Airflow	Noise	Volts	Voltage	Current	Connection Type
6197188	2900	52	31	12	7~13.6	0.25	Wire
6197194	2900	52	31	24	10~27	0.15	Wire