



ENGLISH

Datasheet

Stock No: 382-267

RS Pro M4 x 0.7 Male Steel Rod End



Product Details

Rod End Miniature - Male

Mechanical linkages manufactured from C22/C35 Pb steel, zinc plated and passivated

Hardened ball, ground and polished 100 cr6 ball bearing steel

Inserts are Cu Zn 40 Mn Pb bronze; these bearings require lubrication and are factory filled with Molykate BR2

+/- 13° off-centre movement through 360°



ENGLISH

Specifications:

Connection Size	M4 x 0.7 Male
Bore Size	4mm
Static Load Rating	2040N
Overall Length	37mm
Material	Steel
Connection Thread Size	M4 x 0.7
Connection Thread Standard	Metric
Connection Gender	Male

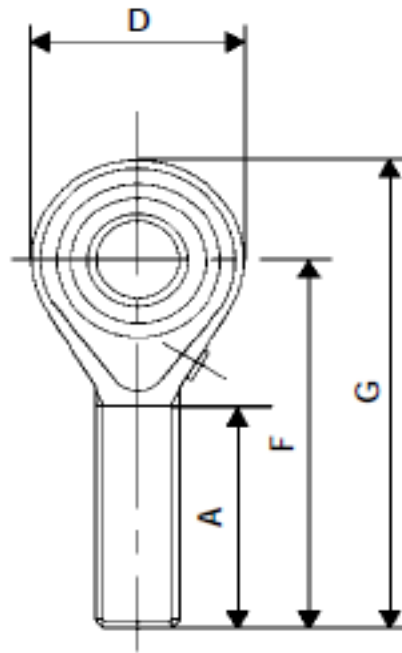
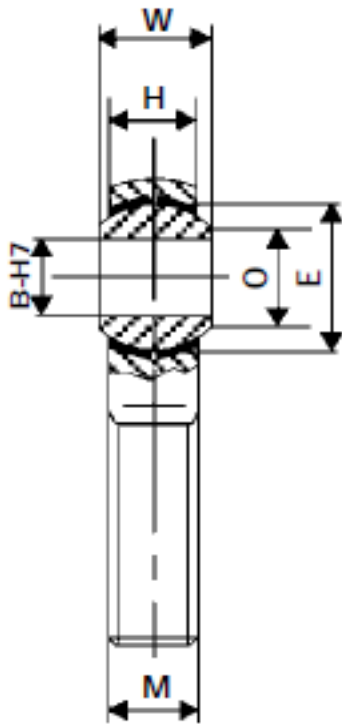

Stock No	Size	Static Load (kN)	Thead	x	Pitch	A	B	C	F	G	H	O	W	Ball dia E	Weight (g)
382245	02	0.40	M2	x	0.4	9	2	9	18	22.5	3.6	3.6	4.8	6.00	2
382251	03	1.20	M3	x	0.5	15	3	12	27	33	4.5	5.18	6	7.93	5
382267	04	2.00	M4	x	0.7	18	4	14	30	37	5.25	6.46	7	9.52	9
382273	05	3.40	M5	x	0.8	20	5	16	33	41	6	7.71	8	11.11	12