

FEATURES

- 250 ps propagation delay input to output
- 50 ps propagation delay dispersion
- Differential PECL compatible outputs
- Differential latch control
- Robust input protection
- Input common-mode range -2.0 V to $+3.0\text{ V}$
- Input differential range $\pm 5\text{ V}$
- ESD protection $>3\text{ kV HBM}$, $>200\text{ V MM}$
- Power supply sensitivity $>65\text{ dB}$
- 200 ps minimum pulse width
- 5 GHz equivalent input rise time bandwidth
- Typical output rise/fall of 165 ps

APPLICATIONS

- High speed instrumentation
- Scope and logic analyzer front ends
- Window comparators
- High speed line receivers and signal restoration
- Threshold detection
- Peak detection
- High speed triggers
- Patient diagnostics
- Disk drive read channel detection
- Hand-held test instruments
- Zero-crossing detectors
- Clock drivers
- Automatic test equipment

GENERAL DESCRIPTION

The [ADCMP567](#) is an ultrafast voltage comparator fabricated on Analog Devices, Inc., proprietary XFCB process. The device features 250 ps propagation delay with less than 35 ps overdrive dispersion. Overdrive dispersion, a particularly important characteristic of high speed comparators, is a measure of the difference in propagation delay under differing overdrive conditions.

FUNCTIONAL BLOCK DIAGRAM

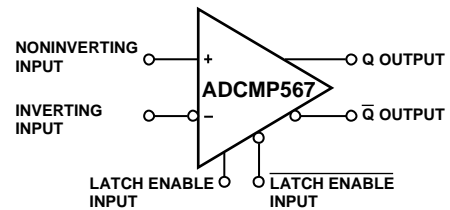

03632-0-001

Figure 1.

A fast, high precision differential input stage permits consistent propagation delay with a wide variety of signals in the common-mode range from -2.0 V to $+3.0\text{ V}$. Outputs are complementary digital signals fully compatible with PECL 10 K and 10 KH logic families. The outputs provide sufficient drive current to directly drive transmission lines terminated in $50\ \Omega$ to $V_{DD} - 2\text{ V}$. A latch input is included, which permits tracking, track-and-hold, or sample-and-hold modes of operation.

The [ADCMP567](#) is available in a 32-lead LFCSP package.

Rev. A

[Document Feedback](#)

Information furnished by Analog Devices is believed to be accurate and reliable. However, no responsibility is assumed by Analog Devices for its use, nor for any infringements of patents or other rights of third parties that may result from its use. Specifications subject to change without notice. No license is granted by implication or otherwise under any patent or patent rights of Analog Devices. Trademarks and registered trademarks are the property of their respective owners.

ADCMP567* Product Page Quick Links

Last Content Update: 11/01/2016

[Comparable Parts](#)

View a parametric search of comparable parts

[Evaluation Kits](#)

- [ADCMP567 Evaluation Board](#)

[Documentation](#)

Data Sheet

- [ADCMP567: 32L-LFCSP Ultra Fast High Speed Comparator PECL Compatible Data Sheet](#)

[Reference Materials](#)

Product Selection Guide

- [Comparators Product Brochure 2007](#)

[Design Resources](#)

- [ADCMP567 Material Declaration](#)
- [PCN-PDN Information](#)
- [Quality And Reliability](#)
- [Symbols and Footprints](#)

[Discussions](#)

View all ADCMP567 EngineerZone Discussions

[Sample and Buy](#)

Visit the product page to see pricing options

[Technical Support](#)

Submit a technical question or find your regional support number

TABLE OF CONTENTS

Features	1	Timing Information	8
Applications.....	1	Applications Information	9
Functional Block Diagram	1	Clock Timing Recovery.....	9
General Description	1	Optimizing High Speed Performance	9
Revision History	2	Comparator Propagation Delay Dispersion.....	9
Specifications.....	3	Comparator Hysteresis	10
Electrical Characteristics	3	Minimum Input Slew Rate Requirement.....	10
Absolute Maximum Ratings.....	5	Typical Application Circuits	11
Thermal Considerations.....	5	Typical Performance Characteristics	12
ESD Caution.....	5	Outline Dimensions	14
Pin Configuration and Function Descriptions.....	6	Ordering Guide	14

REVISION HISTORY

1/15—Rev. 0 to Rev. A

Changes to Figure 2 and Table 3.....	6
Updated Outline Dimensions	14
Changes to Ordering Guide	14

10/03—Revision 0: Initial Version

SPECIFICATIONS

ELECTRICAL CHARACTERISTICS

$V_{CC} = +5.0\text{ V}$, $V_{EE} = -5.2\text{ V}$, $V_{DD} = +3.3\text{ V}$, $T_A = 25^\circ\text{C}$, unless otherwise noted.

Table 1.

Parameter	Symbol	Condition	Min	Typ	Max	Unit
DC INPUT CHARACTERISTICS¹						
Input Common-Mode Range	V_{CM}		-2.0		+3.0	V
Input Differential Voltage			-5		+5	V
Input Offset Voltage	V_{OS}		-5.0	± 1.0	+5.0	mV
Input Offset Voltage Channel Matching				± 1.0		mV
Offset Voltage Tempco	DV_{OS}/dT			10.0		$\mu\text{V}/^\circ\text{C}$
Input Bias Current	I_{BC}		-10	+24	+42	μA
Input Bias Current Tempco				10.0		$\text{nA}/^\circ\text{C}$
Input Offset Current			-8.0	± 0.5	+8.0	μA
Input Capacitance	C_{IN}			0.75		pF
Input Resistance, Differential Mode				100		k Ω
Input Resistance, Common-Mode				600		k Ω
Open Loop Gain				60		dB
Common-Mode Rejection Ratio	CMRR	$V_{CM} = -2.0\text{ V to }+3.0\text{ V}$		69		dB
Hysteresis				± 1.0		mV
LATCH ENABLE CHARACTERISTICS						
Latch Enable Common-Mode Range	V_{LCM}		$V_{DD} - 2.0$		V_{DD}	V
Latch Enable Differential Input Voltage	V_{LD}		0.4		2.0	V
Input High Current		at 0.0 V	-12	+6	+12	μA
Input Low Current		at -2.0 V	-12	+6	+12	μA
Latch Setup Time	t_S	250 mV overdrive		50		ps
Latch to Output Delay	t_{PLOH}, t_{PLOL}	250 mV overdrive		300		ps
Latch Pulse Width	t_{PL}	250 mV overdrive		150		ps
Latch Hold Time	t_H	250 mV overdrive		90		ps
OUTPUT CHARACTERISTICS						
Output Voltage—High Level	V_{OH}	PECL 50 Ω to -2.0 V	$V_{DD} - 1.1$		$V_{DD} - 0.81$	V
Output Voltage—Low Level	V_{OL}	PECL 50 Ω to -2.0 V	$V_{DD} - 1.95$		$V_{DD} - 1.54$	V
Rise Time	t_R	20% to 80%		175		ps
Fall Time	t_F	20% to 80%		140		ps
AC PERFORMANCE						
Propagation Delay	t_{PD}	1 V overdrive		250		ps
Propagation Delay	t_{PD}	20 mV overdrive		300		ps
Propagation Delay Tempco				0.5		$\text{ps}/^\circ\text{C}$
Prop Delay Skew—Rising Transition to Falling Transition				± 10		ps
Within Device Propagation Delay Skew—Channel to Channel				± 10		ps
Propagation Delay Dispersion vs. Duty Cycle				± 10		ps
Propagation Delay Dispersion vs. Overdrive		50 mV to 1.5 V		35		ps
Propagation Delay Dispersion vs. Overdrive		20 mV to 1.5 V		50		ps
Propagation Delay Dispersion vs. Slew Rate		0 V to 1 V swing, 20% to 80%, 50 ps and 600 ps		50		ps
Propagation Delay Dispersion vs. Common-Mode Voltage		1 V swing, -1.5 V to 2.5 V_{CM}		5		ps

Parameter	Symbol	Condition	Min	Typ	Max	Unit
AC PERFORMANCE (continued)						
Equivalent Input Rise Time Bandwidth	BW	0 V to 1 V swing, 20% to 80%, 50 ps t_R , t_F	3500	5000		MHz
Toggle Rate		>50% output swing		5		Gbps
Minimum Pulse Width	PW	Δt_{PD} from 10 ns to 200 ps < ± 25 ps		200		ps
Unit to Unit Propagation Delay Skew				± 10		ps
POWER SUPPLY						
Positive Supply Current	$I_{V_{CC}}$	at +5.0 V	7	13	20	mA
Negative Supply Current	$I_{V_{EE}}$	at -5.2 V	60	78	95	mA
Logic Supply Current	$I_{V_{DD}}$	at 3.3 V, without load	8	13	18	mA
Logic Supply Current	$I_{V_{DD}}$	at 3.3 V, with load	50	65	80	mA
Positive Supply Voltage	V_{CC}	Dual	4.75	5.0	5.25	V
Negative Supply Voltage	V_{EE}	Dual	-4.96	-5.2	-5.45	V
Logic Supply Voltage	V_{DD}	Dual	2.5	3.3	5.0	V
Power Dissipation		Dual, without load	415	515	615	mW
Power Dissipation		Dual, with load		575	675	mW
Power Supply Sensitivity— V_{CC}	$PSS_{V_{CC}}$			69		dB
Power Supply Sensitivity— V_{EE}	$PSS_{V_{EE}}$			85		dB
Power Supply Sensitivity— V_{DD}	$PSS_{V_{DD}}$			70		dB

¹ Under no circumstances should the input voltages exceed the supply voltages.

ABSOLUTE MAXIMUM RATINGS

Table 2.

Parameter	Rating
Supply Voltages	
Positive Supply Voltage (V_{CC} to GND)	–0.5 V to +6.0 V
Negative Supply Voltage (V_{EE} to GND)	–6.0 V to +0.5 V
Logic Supply Voltage (V_{DD} to GND)	–0.5 V to +6.0 V
Ground Voltage Differential	–0.5 V to +0.5 V
Input Voltages	
Input Common-Mode Voltage	–3.0 V to +4.0 V
Differential Input Voltage	–7.0 V to +7.0 V
Input Voltage, Latch Controls	–0.5 V to +5.5 V
Output Current	30 mA
Temperature	
Operating Temperature, Ambient	–40°C to +85°C
Operating Temperature, Junction	125°C
Storage Temperature Range	–65°C to +150°C

Stresses at or above those listed under Absolute Maximum Ratings may cause permanent damage to the product. This is a stress rating only; functional operation of the product at these or any other conditions above those indicated in the operational section of this specification is not implied. Operation beyond the maximum operating conditions for extended periods may affect product reliability.

THERMAL CONSIDERATIONS

The ADCMP567 LFCSP 32-lead package option has a θ_{JA} (junction-to-ambient thermal resistance) of 27.2°C/W in still air.

ESD CAUTION



ESD (electrostatic discharge) sensitive device. Charged devices and circuit boards can discharge without detection. Although this product features patented or proprietary protection circuitry, damage may occur on devices subjected to high energy ESD. Therefore, proper ESD precautions should be taken to avoid performance degradation or loss of functionality.

PIN CONFIGURATION AND FUNCTION DESCRIPTIONS

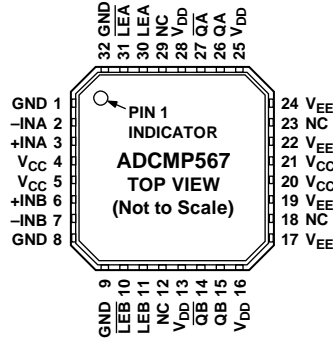

NC = NO CONNECT. DO NOT CONNECT TO THIS PIN.

NOTES
1. THE RECOMMENDED CONNECTION FOR THE EXPOSED PAD IS GROUND.

03832-002

Figure 2. ADCMP567 Pin Configuration

Table 3. ADCMP567 Pin Function Descriptions

Pin No.	Mnemonic	Function
1	GND	Analog Ground.
2	-INA	Inverting analog input of the differential input stage for Channel A. The inverting A input must be driven in conjunction with the noninverting A input.
3	+INA	Noninverting analog input of the differential input stage for Channel A. The noninverting A input must be driven in conjunction with the inverting A input.
4	V _{CC}	Positive Supply Terminal.
5	V _{CC}	Positive Supply Terminal.
6	+INB	Noninverting analog input of the differential input stage for Channel B. The noninverting B input must be driven in conjunction with the inverting B input.
7	-INB	Inverting analog input of the differential input stage for Channel B. The inverting B input must be driven in conjunction with the noninverting B input.
8	GND	Analog Ground.
9	GND	Analog Ground.
10	LEB	One of two complementary inputs for Channel B Latch Enable. In the compare mode (logic low), the output will track changes at the input of the comparator. In the latch mode (logic high), the output will reflect the input state just prior to the comparator's being placed in the latch mode. LEB must be driven in conjunction with LEB.
11	LEB	One of two complementary inputs for Channel B Latch Enable. In the compare mode (logic high), the output will track changes at the input of the comparator. In the latch mode (logic low), the output will reflect the input state just prior to the comparator's being placed in the latch mode. LEB must be driven in conjunction with LEB.
12	NC	No Connect. Do not connect to this pin.
13	V _{DD}	Logic Supply Terminal.
14	QB	One of two complementary outputs for Channel B. QB will be at logic low if the analog voltage at the noninverting input is greater than the analog voltage at the inverting input (provided the comparator is in the compare mode). See the LEB description (Pin 11) for more information.
15	QB	One of two complementary outputs for Channel B. QB will be at logic high if the analog voltage at the noninverting input is greater than the analog voltage at the inverting input (provided the comparator is in the compare mode). See the LEB description (Pin 11) for more information.
16	V _{DD}	Logic Supply Terminal.
17	V _{EE}	Negative Supply Terminal.
18	NC	No Connect. Do not connect to this pin.
19	V _{EE}	Negative Supply Terminal.
20	V _{CC}	Positive Supply Terminal.
21	V _{CC}	Positive Supply Terminal.
22	V _{EE}	Negative Supply Terminal.
23	NC	No Connect. Do not connect to this pin.

Pin No.	Mnemonic	Function
24	V _{EE}	Negative Supply Terminal.
25	V _{DD}	Logic Supply Terminal.
26	QA	One of two complementary outputs for Channel A. QA will be at logic high if the analog voltage at the noninverting input is greater than the analog voltage at the inverting input (provided the comparator is in the compare mode). See the LEA description (Pin 30) for more information.
27	\overline{QA}	One of two complementary outputs for Channel A. \overline{QA} will be at logic low if the analog voltage at the noninverting input is greater than the analog voltage at the inverting input (provided the comparator is in the compare mode). See the LEA description (Pin 30) for more information.
28	V _{DD}	Logic Supply Terminal.
29	NC	No Connect. Do not connect to this pin.
30	LEA	One of two complementary inputs for Channel A Latch Enable. In the compare mode (logic high), the output will track changes at the input of the comparator. In the latch mode (logic low), the output will reflect the input state just prior to the comparator's being placed in the latch mode. LEA must be driven in conjunction with \overline{LEA} .
31	\overline{LEA}	One of two complementary inputs for Channel A Latch Enable. In the compare mode (logic low), the output will track changes at the input of the comparator. In the latch mode (logic high), the output will reflect the input state just prior to the comparator's being placed in the latch mode. LEA must be driven in conjunction with LEA.
32	GND EPAD	Analog Ground. Exposed Pad. The recommended connection for the exposed pad is ground.

TIMING INFORMATION

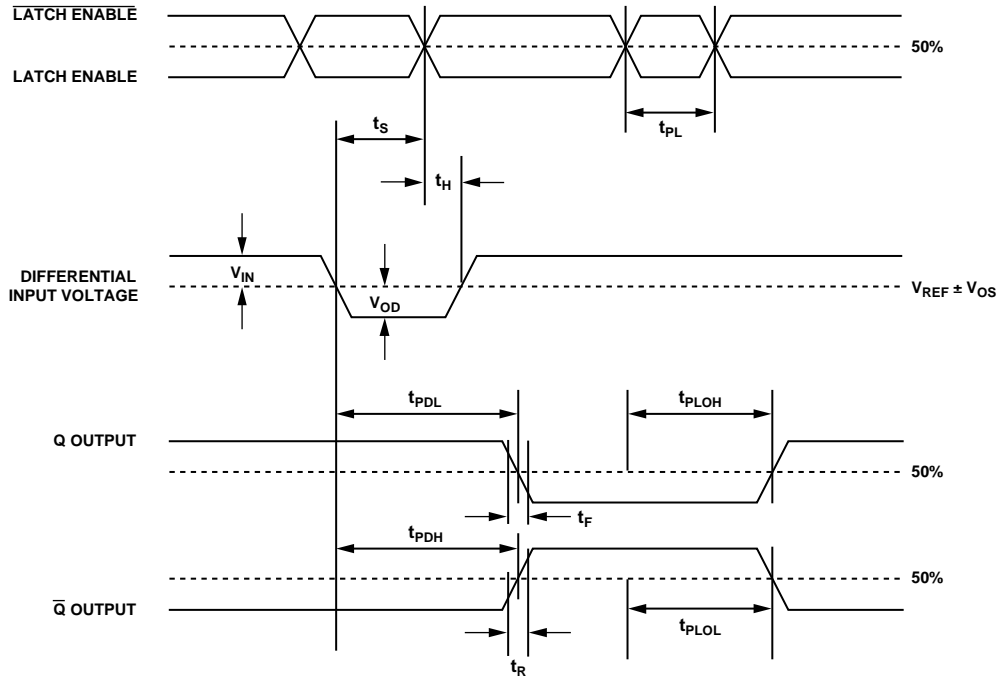

03633-0-003

Figure 3. System Timing Diagram

The timing diagram in Figure 3 shows the ADCMP567 compare and latch features. Table 4 describes the terms in the diagram.

Table 4. Timing Descriptions

Symbol	Timing	Description
t_{PDH}	Input to output high delay	Propagation delay measured from the time the input signal crosses the reference (\pm the input offset voltage) to the 50% point of an output low-to-high transition
t_{PDL}	Input to output low delay	Propagation delay measured from the time the input signal crosses the reference (\pm the input offset voltage) to the 50% point of an output high-to-low transition
t_{PLOH}	Latch enable to output high delay	Propagation delay measured from the 50% point of the Latch Enable signal low-to-high transition to the 50% point of an output low-to-high transition
t_{PLOL}	Latch enable to output low delay	Propagation delay measured from the 50% point of the Latch Enable signal low-to-high transition to the 50% point of an output high-to-low transition
t_H	Minimum hold time	Minimum time after the negative transition of the Latch Enable signal that the input signal must remain unchanged to be acquired and held at the outputs
t_{PL}	Minimum latch enable pulse width	Minimum time that the Latch Enable signal must be high to acquire an input signal change
t_S	Minimum setup time	Minimum time before the negative transition of the Latch Enable signal that an input signal change must be present to be acquired and held at the outputs
t_R	Output rise time	Amount of time required to transition from a low to a high output as measured at the 20% and 80% points
t_F	Output fall time	Amount of time required to transition from a high to a low output as measured at the 20% and 80% points
V_{OD}	Voltage overdrive	Difference between the differential input and reference input voltages

APPLICATIONS INFORMATION

The [ADCMP567](#) comparators are very high speed devices. Consequently, high speed design techniques must be employed to achieve the best performance. The most critical aspect of any [ADCMP567](#) design is the use of a low impedance ground plane. A ground plane, as part of a multilayer board, is recommended for proper high speed performance. Using a continuous conductive plane over the surface of the circuit board can create this, allowing breaks in the plane only for necessary signal paths. The ground plane provides a low inductance ground, eliminating any potential differences at different ground points throughout the circuit board caused by ground bounce. A proper ground plane also minimizes the effects of stray capacitance on the circuit board.

It is also important to provide bypass capacitors for the power supply in a high speed application. A 1 μF electrolytic bypass capacitor should be placed within 0.5 inches of each power supply pin to ground. These capacitors will reduce any potential voltage ripples from the power supply. In addition, a 10 nF ceramic capacitor should be placed as close as possible from the power supply pins on the [ADCMP567](#) to ground. These capacitors act as a charge reservoir for the device during high frequency switching.

The LATCH ENABLE input is active low (latched). If the latching function is not used, the LATCH ENABLE input should be attached to V_{DD} (V_{DD} is a PECL logic high), and the complementary input, $\overline{\text{LATCH ENABLE}}$, should be tied to $V_{\text{DD}} - 2.0\text{ V}$. This will disable the latching function.

Occasionally, one of the two comparator stages within the [ADCMP567](#) will not be used. The inputs of the unused comparator should not be allowed to float. The high internal gain may cause the output to oscillate (possibly affecting the comparator that is being used) unless the output is forced into a fixed state. This is easily accomplished by ensuring that the two inputs are at least one diode drop apart, while also appropriately connecting the LATCH ENABLE and $\overline{\text{LATCH ENABLE}}$ inputs as described above.

The best performance is achieved with the use of proper PECL terminations. The open emitter outputs of the [ADCMP567](#) are designed to be terminated through 50 Ω resistors to $V_{\text{DD}} - 2.0\text{ V}$, or any other equivalent PECL termination. If high speed PECL signals must be routed more than a centimeter, microstrip or stripline techniques may be required to ensure proper transition times and prevent output ringing.

CLOCK TIMING RECOVERY

Comparators are often used in digital systems to recover clock timing signals. High speed square waves transmitted over a distance, even tens of centimeters, can become distorted due to stray capacitance and inductance. Poor layout or improper termination can also cause reflections on the transmission line, further distorting the signal waveform. A high speed comparator can be used to recover the distorted waveform while maintaining a minimum of delay.

OPTIMIZING HIGH SPEED PERFORMANCE

As with any high speed comparator amplifier, proper design and layout techniques should be used to ensure optimal performance from the [ADCMP567](#). The performance limits of high speed circuitry can easily be a result of stray capacitance, improper ground impedance, or other layout issues.

Minimizing resistance from source to the input is an important consideration in maximizing the high speed operation of the [ADCMP567](#). Source resistance in combination with equivalent input capacitance could cause a lagged response at the input, thus delaying the output. The input capacitance of the [ADCMP567](#) in combination with stray capacitance from an input pin to ground could result in several picofarads of equivalent capacitance. A combination of 3 k Ω source resistance and 5 pF of input capacitance yields a time constant of 15 ns, which is significantly slower than the sub 500 ps capability of the [ADCMP567](#). Source impedances should be significantly less than 100 Ω for best performance.

Sockets should be avoided due to stray capacitance and inductance. If proper high speed techniques are used, the [ADCMP567](#) should be free from oscillation when the comparator input signal passes through the switching threshold.

COMPARATOR PROPAGATION DELAY DISPERSION

The [ADCMP567](#) has been specifically designed to reduce propagation delay dispersion over an input overdrive range of 100 mV to 1 V. Propagation delay overdrive dispersion is the change in propagation delay that results from a change in the degree of overdrive (how far the switching point is exceeded by the input). The overall result is a higher degree of timing accuracy since the [ADCMP567](#) is far less sensitive to input variations than most comparator designs.

Propagation delay dispersion is a specification that is important in critical timing applications such as ATE, bench instruments, and nuclear instrumentation. Overdrive dispersion is defined

as the variation in propagation delay as the input overdrive conditions are changed (see Figure 4). For the ADCMP567, overdrive dispersion is typically 35 ps as the overdrive is changed from 100 mV to 1 V. This specification applies for both positive and negative overdrive since the ADCMP567 has equal delays for positive and negative going inputs.

The 35 ps propagation delay overdrive dispersion of the ADCMP567 offers considerable improvement of the 100 ps dispersion of other similar series comparators.

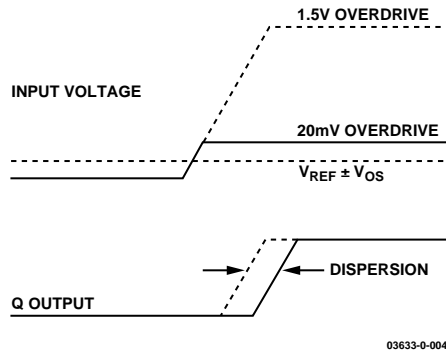

Figure 4. Propagation Delay Dispersion

COMPARATOR HYSTERESIS

The addition of hysteresis to a comparator is often useful in a noisy environment or where it is not desirable for the comparator to toggle between states when the input signal is at the switching threshold. The transfer function for a comparator with hysteresis is shown in Figure 5. If the input voltage approaches the threshold from the negative direction, the comparator will switch from a 0 to a 1 when the input crosses $+V_H/2$. The new switching threshold becomes $-V_H/2$. The comparator will remain in a 1 state until the threshold $-V_H/2$ is crossed coming from the positive direction. In this manner, noise centered on 0 V input will not cause the comparator to switch states unless it exceeds the region bounded by $\pm V_H/2$.

Positive feedback from the output to the input is often used to produce hysteresis in a comparator (see Figure 9). The major problem with this approach is that the amount of hysteresis varies with the output logic levels, resulting in a hysteresis that is not symmetrical around zero.

Another method to implement hysteresis is generated by introducing a differential voltage between LATCH ENABLE and LATCH ENABLE inputs (see Figure 10). Hysteresis generated in this manner is independent of output swing and is symmetrical around zero. The variation of hysteresis with input voltage is shown in Figure 6.

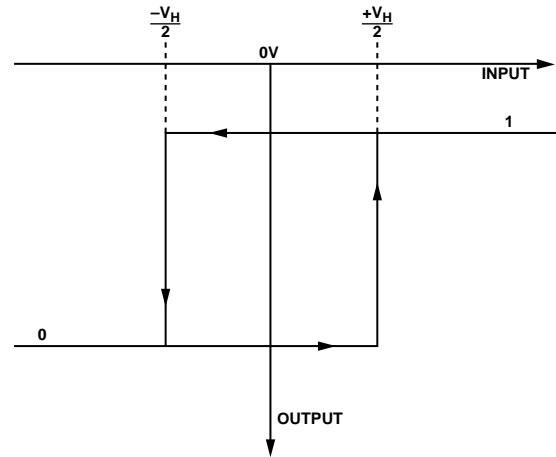

Figure 5. Comparator Hysteresis Transfer Function

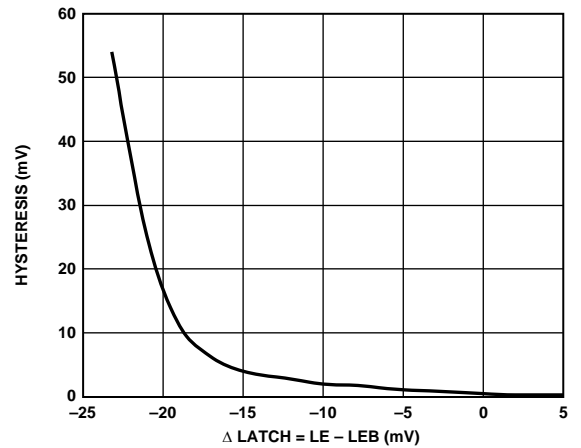
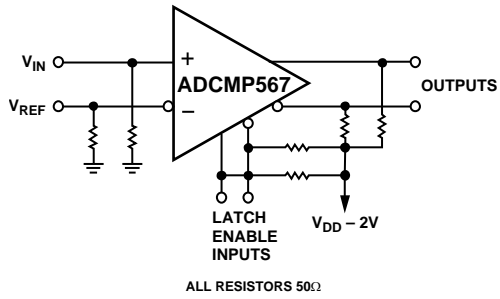

Figure 6. Comparator Hysteresis Transfer Function Using Latch Enable Input

MINIMUM INPUT SLEW RATE REQUIREMENT

As for all high speed comparators, a minimum slew rate must be met to ensure that the device does not oscillate when the input crosses the threshold. This oscillation is due in part to the high input bandwidth of the comparator and the parasitics of the package. Analog Devices recommends a slew rate of 5 V/μs or faster to ensure a clean output transition. If slew rates less than 5 V/μs are used, then hysteresis should be added to reduce the oscillation.

TYPICAL APPLICATION CIRCUITS



03632-0-007

Figure 7. High Speed Sampling Circuits

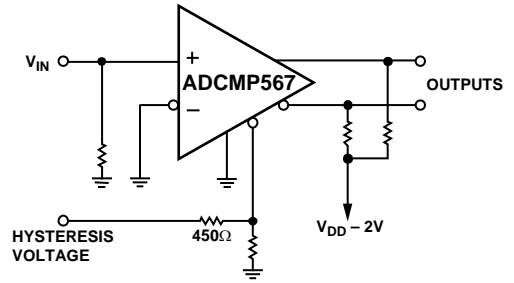

03632-0-010

Figure 10. Hysteresis Using Latch Enable Input

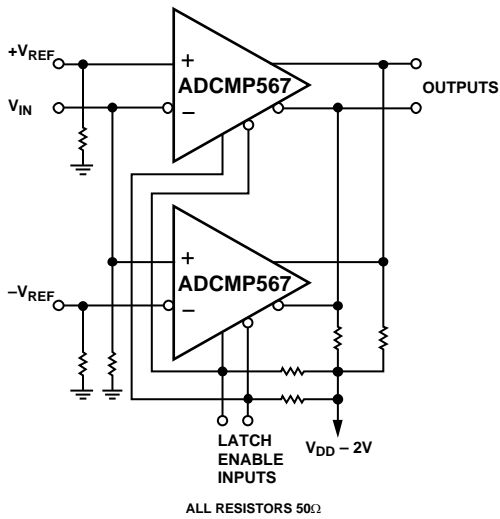

03632-0-008

Figure 8. High Speed Window Comparator

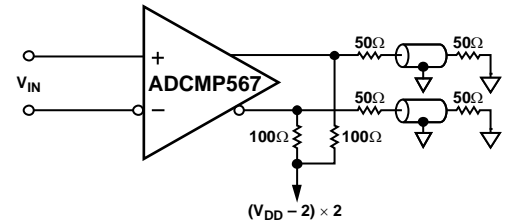
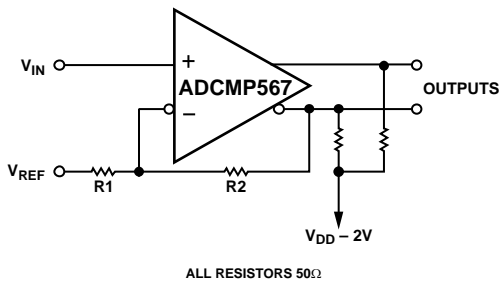

Figure 11. How to Interface a PECL Output to an Instrument with a 50Ω to Ground Input



03632-0-009

Figure 9. Hysteresis Using Positive Feedback

TYPICAL PERFORMANCE CHARACTERISTICS

VCC = +5.0 V, VEE = -5.2 V, VDD = +3.3 V, TA = 25°C, unless otherwise noted.

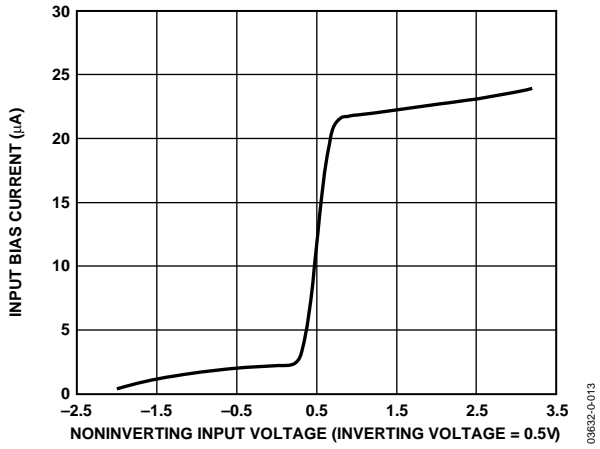

Figure 12. Input Bias Current vs. Input Voltage

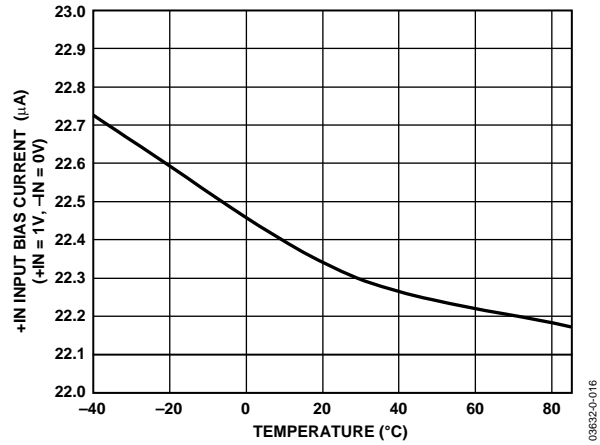

Figure 15. Input Bias Current vs. Temperature

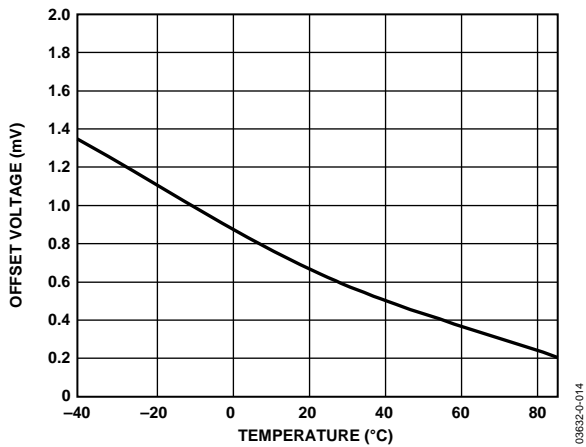

Figure 13. Input Offset Voltage vs. Temperature

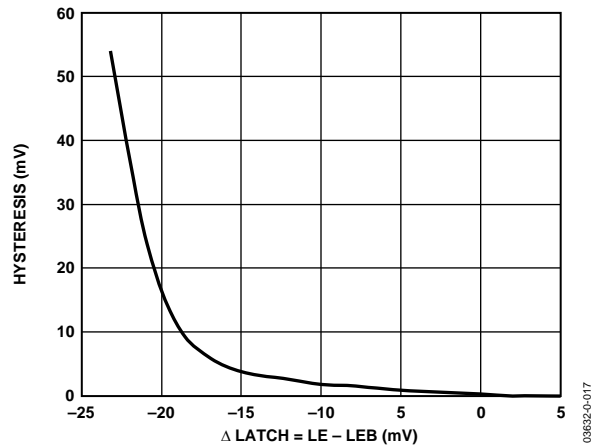

Figure 16. Hysteresis vs. ΔLatch

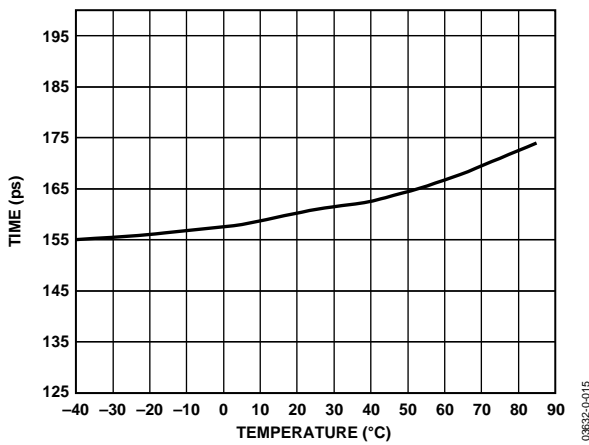

Figure 14. Rise Time vs. Temperature

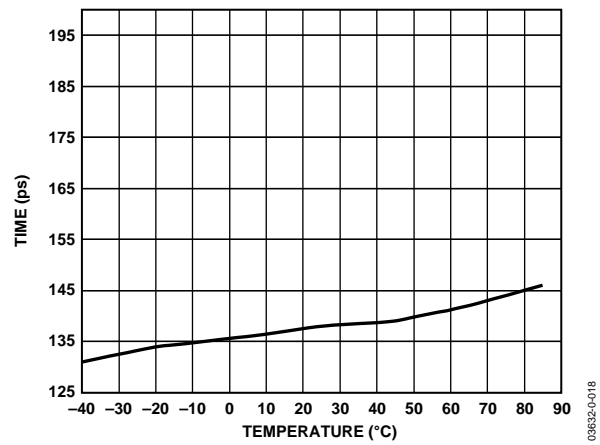

Figure 17. Fall Time vs. Temperature

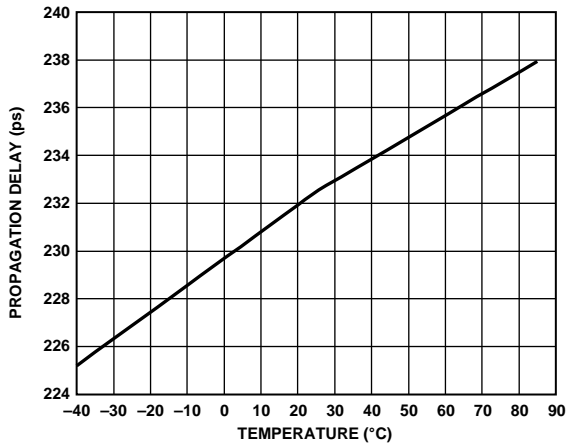

Figure 18. Propagation Delay vs. Temperature

03632-0-019

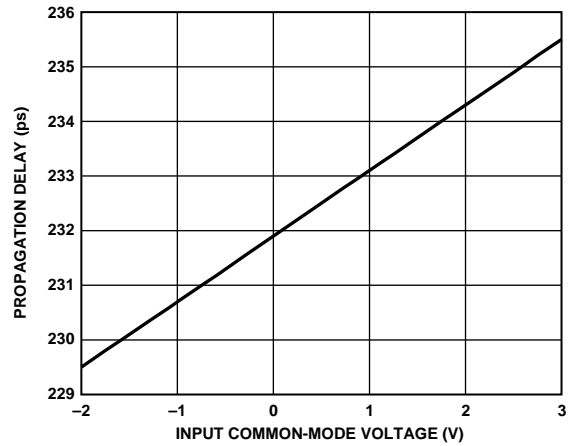

Figure 21. Propagation Delay vs. Common-Mode Voltage

03632-0-022

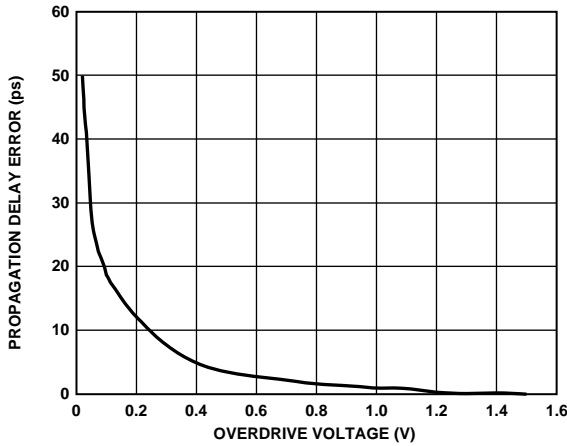

Figure 19. Propagation Delay Error vs. Overdrive Voltage

03632-0-020

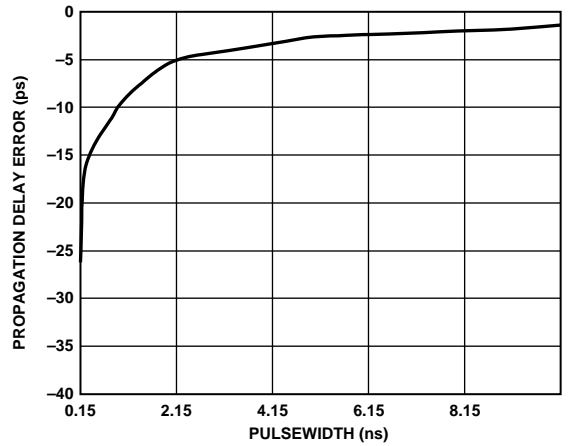

Figure 22. Propagation Delay Error vs. Pulse Width

03632-0-023

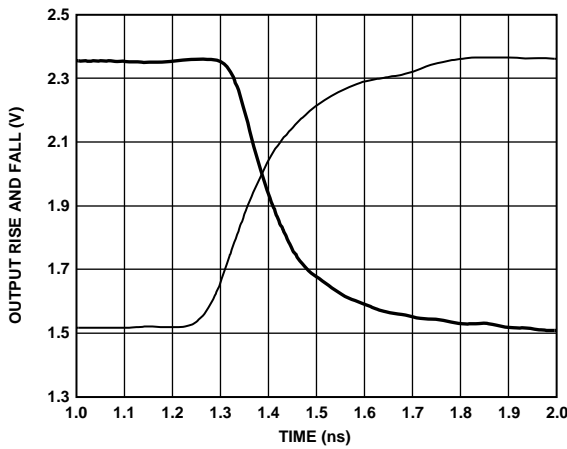
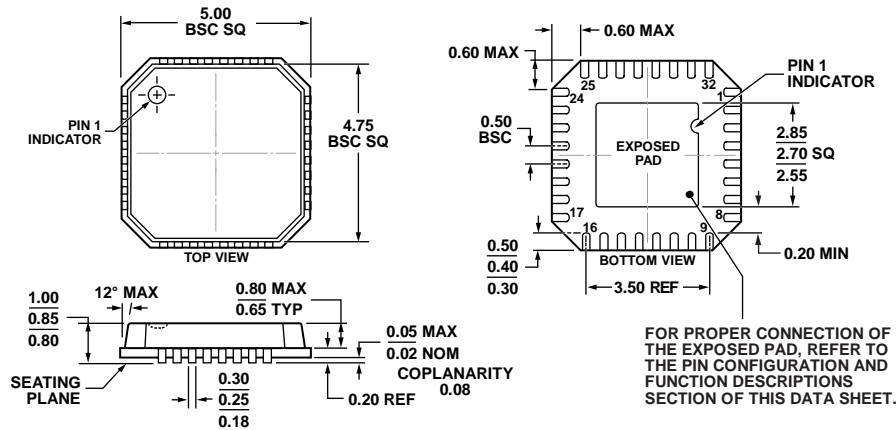

Figure 20. Rise and Fall of Outputs vs. Time

03632-0-021

OUTLINE DIMENSIONS



COMPLIANT TO JEDEC STANDARDS MO-220-VHHD-2

Figure 23. 32-Lead Lead Frame Chip Scale Package [LFCSP_VQ]
 5 mm × 5 mm Body, Very Thin Quad
 (CP-32-8)
 Dimensions shown in millimeters

05-24-2012-A

ORDERING GUIDE

Model ¹	Temperature Range	Package Description	Package Option
ADCMP567BCPZ	-40°C to +85°C	32-Lead Lead Frame Chip Scale Package [LFCSP_VQ]	CP-32-8

¹ Z = RoHS Compliant Part