

Datasheet

RS Pro Satin Aluminium Bolt Fix Pull Handle

RS Stock No: 726-4191

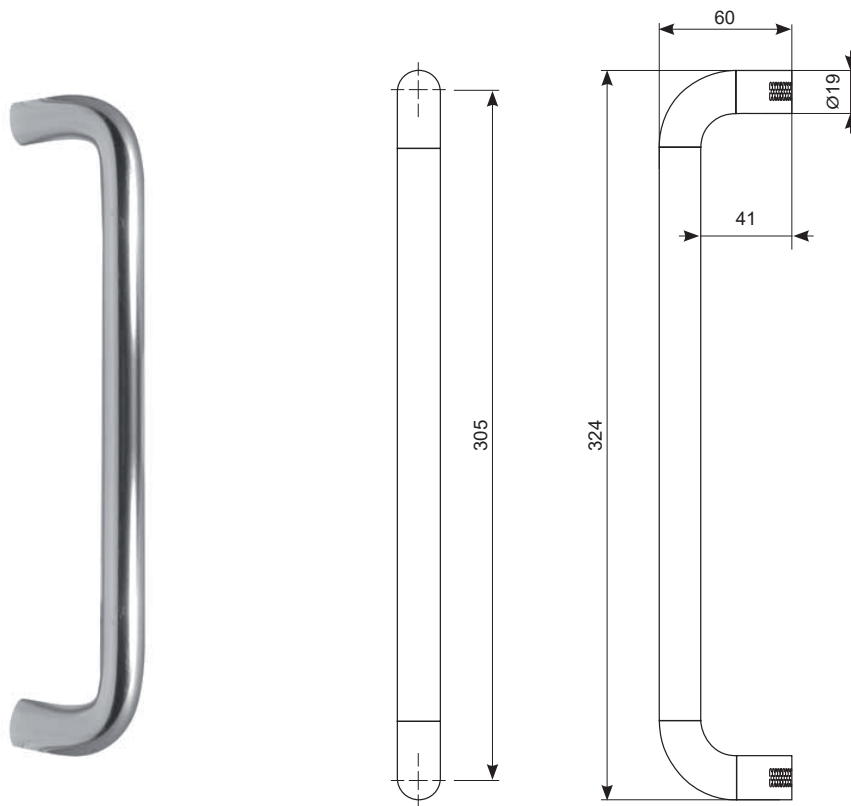

Product Details

Made of aluminium with a satin finish.

Suitable for commercial environments.

Door thickness of 37-57mm.

Diameter of 19mm.

8mm fixing bolts.

41mm clearance between door and inside of handle.