

RE17RMMU

Harmony, Modular timing relay, 8 A, 1 CO, 1 s..100 h, multifunction, 24 V DC / 24...240 V AC/DC



Main

Range of product	Harmony Timer Relays
Product or component type	Multifunction relay
Discrete output type	Relay
Width	17.5 mm
Device short name	RE17R
Time delay type	Power on-delay On-delay and off-delay Interval Off-delay Symmetrical flashing
Time delay range	6...60 min 1...10 h 0.1...1 s 1...10 s 1...10 min 10...100 h 6...60 s
Nominal output current	8 A

Complementary

Contacts type and composition	1 C/O
Contacts material	Cadmium free
Height	90 mm
Depth	72 mm
Control type	Selector switch front panel
[Us] rated supply voltage	24...240 V AC 50/60 Hz 24 V DC
Voltage range	0.85...1.1 Us
Supply frequency	50...60 Hz +/- 5 %
Release of input voltage	10 V
Connections - terminals	Screw terminals, 1 x 0.5...1 x 3.3 mm ² (AWG 20...AWG 12) solid without cable end Screw terminals, 2 x 0.5...2 x 2.5 mm ² (AWG 20...AWG 14) solid without cable end Screw terminals, 1 x 0.2...1 x 2.5 mm ² (AWG 24...AWG 14) flexible with cable end Screw terminals, 2 x 0.2...2 x 1.5 mm ² (AWG 24...AWG 16) flexible with cable end
Tightening torque	0.6...1 N.m conforming to IEC 60947-1
Housing material	Self-extinguishing
Repeat accuracy	+/- 0.5 % conforming to IEC 61812-1
Temperature drift	+/- 0.05 %/°C
Voltage drift	+/- 0.2 %/V
Setting accuracy of time delay	+/- 10 % of full scale at 25 °C conforming to IEC 61812-1
Control signal pulse width	100 ms with load in parallel typical 30 ms typical
Insulation resistance	100 MOhm at 500 V DC conforming to IEC 60664-1
Reset time	120 ms on de-energisation typical
On-load factor	100 %
Power consumption in VA	0...32 VA at 240 V AC
Maximum power consumption in W	0.6 W at 24 V DC

Minimum switching current	10 mA at 5 V DC
Maximum switching current	8 A AC/DC
Maximum switching voltage	250 V AC
Breaking capacity	2000 VA
Operating frequency	10 Hz
Electrical durability	100000 cycles (8 A at 250 V AC maximum) for resistive load
Mechanical durability	10000000 cycles
Dielectric strength	2.5 kV 1 mA/1 minute 50 Hz conforming to IEC 61812-1
[Uimp] rated impulse withstand voltage	5 kV during 1.2/50 μ s
Power on delay	100 ms
Marking	CE
Creepage distance	4 kV/3 conforming to IEC 60664-1
Safety reliability data	B10d = 270000 MTTFd = 296.8 years
Mounting position	Any position in relation to normal vertical mounting plane
Mounting support	35 mm DIN rail conforming to EN/IEC 60715
Local signalling	LED indicator for on steady: relay energised, no timing in progress LED indicator for flashing: timing in progress 80 % ON and 20 % OFF LED indicator for pulsing: relay de-energised, no timing in progress (except function Di-D, Li-L) 5 % ON and 95 % OFF
Product weight	0.07 kg
Time delay type	A, Ac, At, B, Bw, C, D, Di, H, Ht
Functionality	Multifunction
Compatibility code	RE17

Environment

Immunity to microbreaks	20 ms
Standards	2006/95/EC 2004/108/EC IEC 61812-1 EN 61000-6-2 EN 61000-6-3 EN 61000-6-4 EN 61000-6-1
Product certifications	CSA GL cULus
Ambient air temperature for storage	-30...60 °C
Ambient air temperature for operation	-20...60 °C
IP degree of protection	IP20 (terminal block) conforming to IEC 60529 IP40 (housing) conforming to IEC 60529 IP50 (front panel) conforming to IEC 60529
Vibration resistance	20 m/s ² (f= 10...150 Hz) conforming to IEC 60068-2-6
Shock resistance	15 gn for 11 ms conforming to IEC 60068-2-27
Relative humidity	93 % without condensation conforming to IEC 60068-2-30
Electromagnetic compatibility	Electrostatic discharge immunity test: (in contact), level 3, 6 kV, conforming to IEC 61000-4-2 Electrostatic discharge immunity test: (in air), level 3, 8 kV, conforming to IEC 61000-4-2 Susceptibility to electromagnetic fields: (80 MHz to 1 GHz), level 3, 10 V/m, conforming to IEC 61000-4-3 Electrical fast transient/burst immunity test: (capacitive connecting clip), level 3, 1 kV, conforming to IEC 61000-4-4 Electrical fast transient/burst immunity test: (direct), level 3, 2 kV, conforming to IEC 61000-4-4 1.2/50 μ s shock waves immunity test: (differential mode), level 3, 1 kV, conforming to IEC 61000-4-5 1.2/50 μ s shock waves immunity test: (common mode), level 3, 2 kV, conforming to IEC 61000-4-5 Conducted RF disturbances: (0.15...80 MHz), level 3, 10 V, conforming to IEC 61000-4-6 Voltage dips and interruptions immunity test: (1 cycle), 0 %, conforming to IEC 61000-4-11 Voltage dips and interruptions immunity test: (25/30 cycles), 70 %, conforming to IEC 61000-4-11 Conducted and radiated emissions: , class B, conforming to EN 55022

Packing Units

Unit Type of Package 1	PCE
Number of Units in Package 1	1
Package 1 Height	2.600 cm
Package 1 Width	7.800 cm
Package 1 Length	9.500 cm
Package 1 Weight	80.000 g
Unit Type of Package 2	S02
Number of Units in Package 2	40
Package 2 Height	15.000 cm
Package 2 Width	30.000 cm
Package 2 Length	40.000 cm
Package 2 Weight	3.690 kg
Unit Type of Package 3	P06
Number of Units in Package 3	640
Package 3 Height	75.000 cm
Package 3 Width	60.000 cm
Package 3 Length	80.000 cm
Package 3 Weight	65.700 kg

Offer Sustainability

Sustainable offer status	Green Premium product
REACH Regulation	REACH Declaration
EU RoHS Directive	Pro-active compliance (Product out of EU RoHS legal scope) EU RoHS Declaration
Mercury free	Yes
China RoHS Regulation	China RoHS Declaration
RoHS exemption information	Yes
Environmental Disclosure	Product Environmental Profile
Circularity Profile	End Of Life Information
California proposition 65	WARNING: This product can expose you to chemicals including: Lead and lead compounds, which is known to the State of California to cause cancer and birth defects or other reproductive harm. For more information go to www.P65Warnings.ca.gov

Width 17.5 mm

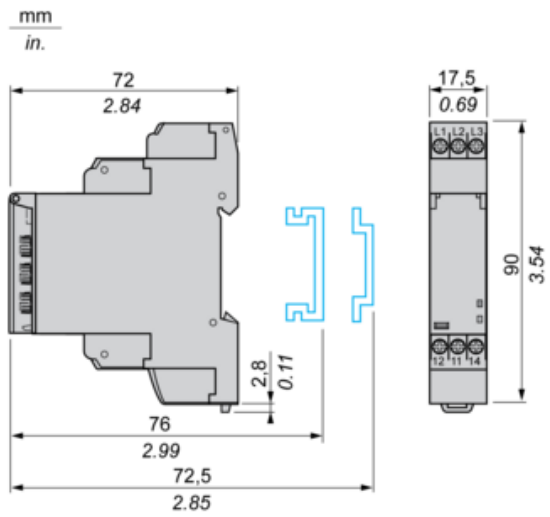

Internal Wiring Diagram

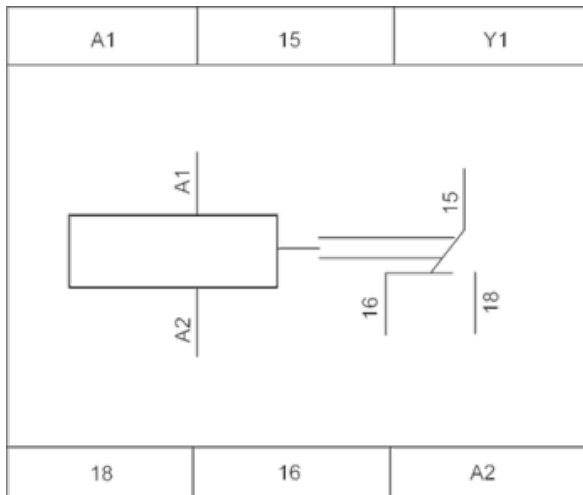

Wiring Diagram

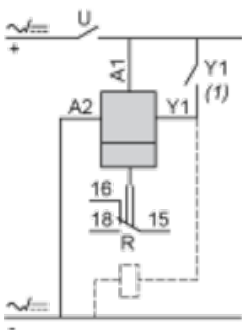

1) Contact Y1:

- Control for functions B, C, Ac, Bw, Ad, Ah, N, O, W, T, Tt.
- Partial stop for functions At, Ht and Pt.
- Function D if Di selected.
- Not used for functions A, H and P.

Function A : Power on Delay Relay

Description

The timing period T begins on energisation. After timing, the output(s) R close(s). The second output can be either timed or instantaneous.

Function: 1 Output



Function: 2 Outputs

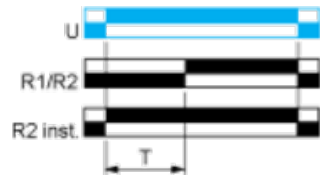

2 timed outputs (R1/R2) or 1 timed output (R1) and 1 instantaneous output (R2 inst.)

Function Ac: On-Delay & Off-Delay with Control Signal

Description

After energisation of power supply and energization of Y1 causes the timing period T to start.

At the end of this timing period, the output(s) R close(s).

When deenergization of Y1, the timing T starts.

At the end of this timing period T, the output(s) R revert(s) to its/their initial position.

The second output (R2) can be either timed (when set to "TIMED") or instantaneous (when set to "INST").

Function: 1 Output

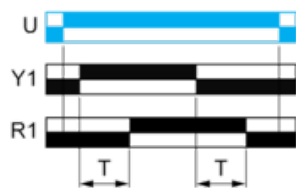

Function: 2 Outputs

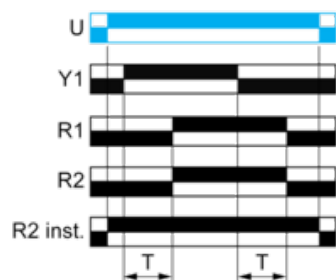

Function At : Power on Delay Relay (Summation) with Control Signal

Description

After power-up, the first opening of control contact C starts the timing. Timing can be interrupted each time control contact closes. When the cumulative total of time periods elapsed reaches the pre-set value T, the output relay closes.

Function: 1 Output

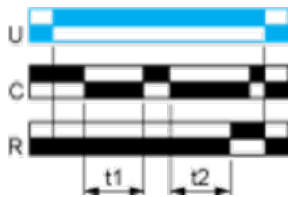

$$T = t1 + t2 + \dots$$

Function B : Interval Relay with Control Signal

Description

After power-up, pulsing or maintaining control contact C starts the timing T. The output R closes for the duration of the timing period T then reverts to its initial state.

Function: 1 Output

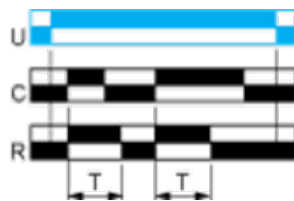

Function Bw : Double Interval Relay with Control Signal

Description

On closing and opening of control contact C, the output R closes for the duration of the timing period T.

Function: 1 Output



Function C : Off-Delay Relay with Control Signal

Description

After power-up and closing of the control contact C, the output R closes. When control contact C re-opens, timing T starts. At the end of the timing period, the output(s) R revert(s) to its/their initial state. The second output can be either timed or instantaneous.

Function: 1 Output

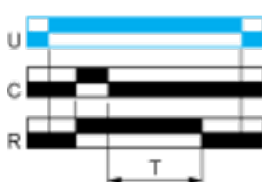

Function: 2 Outputs

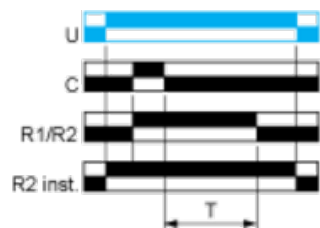

2 timed outputs (R1/R2) or 1 timed output (R1) and 1 instantaneous output (R2 inst.)

Function D: Symmetrical Flashing Relay (Starting Pulse Off)

Description

On energisation of power supply, output(s) R starts at its/their initial state for timing duration T then change(s) to output(s) R close(s) for the same timing duration T. This cycle is repeated indefinitely until power supply removal. Specially for RE17*, RE22R2AMU, RE22R2MMW, RE22R2MMU, RE22R2MJU, this D function can only be initiated by energizing Y1 permanently. The second output (R2) can be either timed (when set to "TIMED") or instantaneous (when set to "INST").

Function: 1 Output

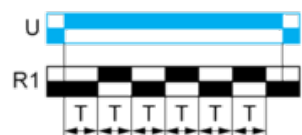

Function: 2 Outputs

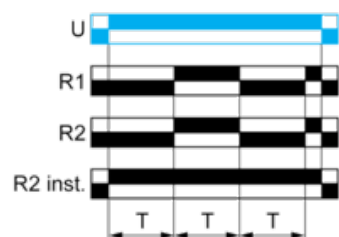

Function: 1 Output with Retrigger / Restart Control

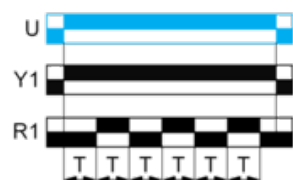

Function: 2 Output with Retrigger / Restart Control

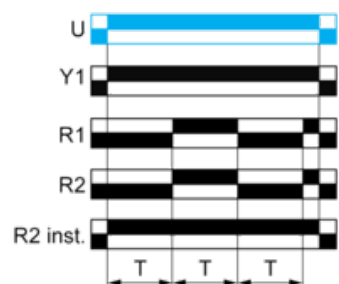

Function Di : Symmetrical Flasher Relay (Starting Pulse On)

Description

Repetitive cycle with two timing periods T of equal duration, with output(s) R changing state at the end of each timing period T. The second output can be either timed or instantaneous.

Function: 1 Output



Function: 2 Outputs



2 timed outputs (R1/R2) or 1 timed output (R1) and 1 instantaneous output (R2 inst.)

Function H : Interval Relay

Description

On energisation of the relay, timing period T starts and the output(s) R close(s). At the end of the timing period T, the output(s) R revert(s) to its/their initial state. The second output can be either timed or instantaneous.

Function: 1 Output



Function: 2 Outputs

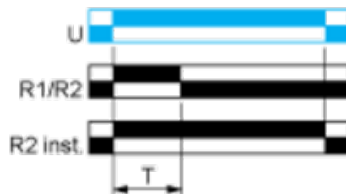

2 timed outputs (R1/R2) or 1 timed output (R1) and 1 instantaneous output (R2 inst.)

Function Ht: Interval Relay & With Pause / Summation Control

Description

On energisation of power supply, output(s) R close(s) and timing period T starts.

The timing can be interrupted / paused each time X1 energizes.

When the cumulative total of time periods elapsed reaches the pre-set value T, the output(s) R revert(s) to its/their initial state. Reenergization of X1 will also cause output(s) R close(s) if the time has elapsed and restart the same operation as described at the beginning.

Except for RE17*, RE22R2MMW, RENF22R2MMW, RE22R2MMU and RE22R2MJU, timing can be interrupted / paused each time Y1 energizes.

The second output (R2) can be either timed (when set to "TIMED" or instantaneous (when set to "INST").

Function: 1 Output

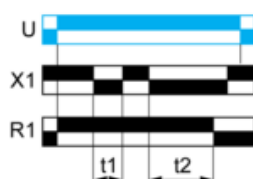

$T = t1 + t2 + \dots$

Function: 2 Outputs

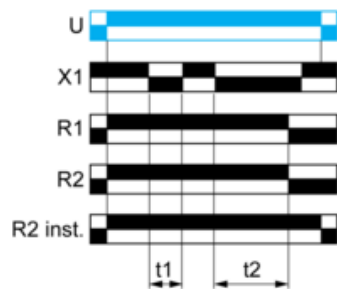

$T = t_1 + t_2 + \dots$

Function: 1 Output with Retrigger / Restart Control

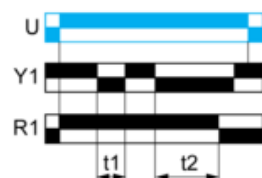

$T = t_1 + t_2 + \dots$

Function: 2 Outputs with Retrigger / Restart Control

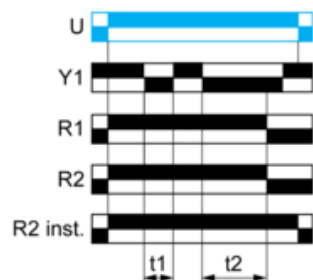

$T = t_1 + t_2 + \dots$

Legend

Relay de-energised

Relay energised

Output open

Output closed

C	Control contact
G	Gate
R	Relay or solid state output
R1/R2	2 timed outputs
R2 inst.	The second output is instantaneous if the right position is selected
T	Timing period
Ta -	Adjustable On-delay
Tr -	Adjustable Off-delay
U	Supply