

PacT Series  
ComPacT NSX  
ComPacT INS/INV  
MasterPacT NW  
DC - DC PV - DC EP

**Catalog 2022**

Power Circuit Breakers and  
Switch-Disconnectors  
Direct Current from 16 to 4000 A



## Legal Information

The information provided in this Catalog contains description of Schneider Electric products, solutions and services ("Offer") with technical specifications and technical characteristics of the performance of the corresponding Offer.

**The content of this document is subject to revision at any time without notice due to continued progress in methodology, design and manufacturing.**

To the extent permitted by applicable law, no responsibility or liability is assumed by Schneider Electric and its subsidiaries for any type of damages arising out of or in connection with (i) informational content of this Catalog not conforming with or exceeding the technical specifications, or (ii) any error contained in this Catalog, or (iii) any use, decision, act or omission made or taken on basis of or in reliance on any information contained or referred to in this Catalog.

**SCHNEIDER ELECTRIC MAKES NO WARRANTY OR REPRESENTATION OF ANY KIND, WHETHER EXPRESS OR IMPLIED, AS TO WHETHER THIS CATALOG OR ANY INFORMATION CONTAINED THEREIN SUCH AS PRODUCTS AND SERVICES WILL MEET REQUIREMENTS, EXPECTATIONS OR PURPOSE OF ANY PERSON MAKING USE THEREOF.**

Schneider Electric brand and any trademarks of Schneider Electric and its subsidiaries referred to in this Catalog are property of Schneider Electric or its subsidiaries. All other brands are trademarks of their respective owners.

This Catalog and its content are protected under applicable copyright laws and provided for informative use only. No part of this Catalog may be reproduced or transmitted in any form or by any means (electronic, mechanical, photocopying, recording, or otherwise), for any purpose, without the prior written permission of Schneider Electric.

Copyright, intellectual, and all other proprietary rights in the content of this Catalog (including but not limited to software, audio, video, text, and photographs) rests with Schneider Electric or its licensors. All rights in such content not expressly granted herein are reserved. No rights of any kind are licensed or assigned or shall otherwise pass to persons accessing this information.

## Trademarks

QR Code is a registered trademark of DENSO WAVE INCORPORATED in Japan and other countries.



## ComPacT NSX, ComPacT INS/INV and MasterPact NW Direct Current

# A Complete DC Offer from 16 to 4000 A

ComPacT NSX, ComPacT INS/INV and MasterPact NW direct current (DC) circuit breakers are used to protect and control low-voltage distribution systems.

They are installed in main low-voltage switchboards (MLVS) and in distribution switchboards (as incomers and outgoers). They can use all the accessories and auxiliaries for the AC ranges and are thus suitable for most DC systems and applications.



# A Complete Molded Case Circuit Breaker DC Offer from 80 to 500 A

## ComPacT NSX DC from 16 to 1200 A from 250 V DC to 750 V DC

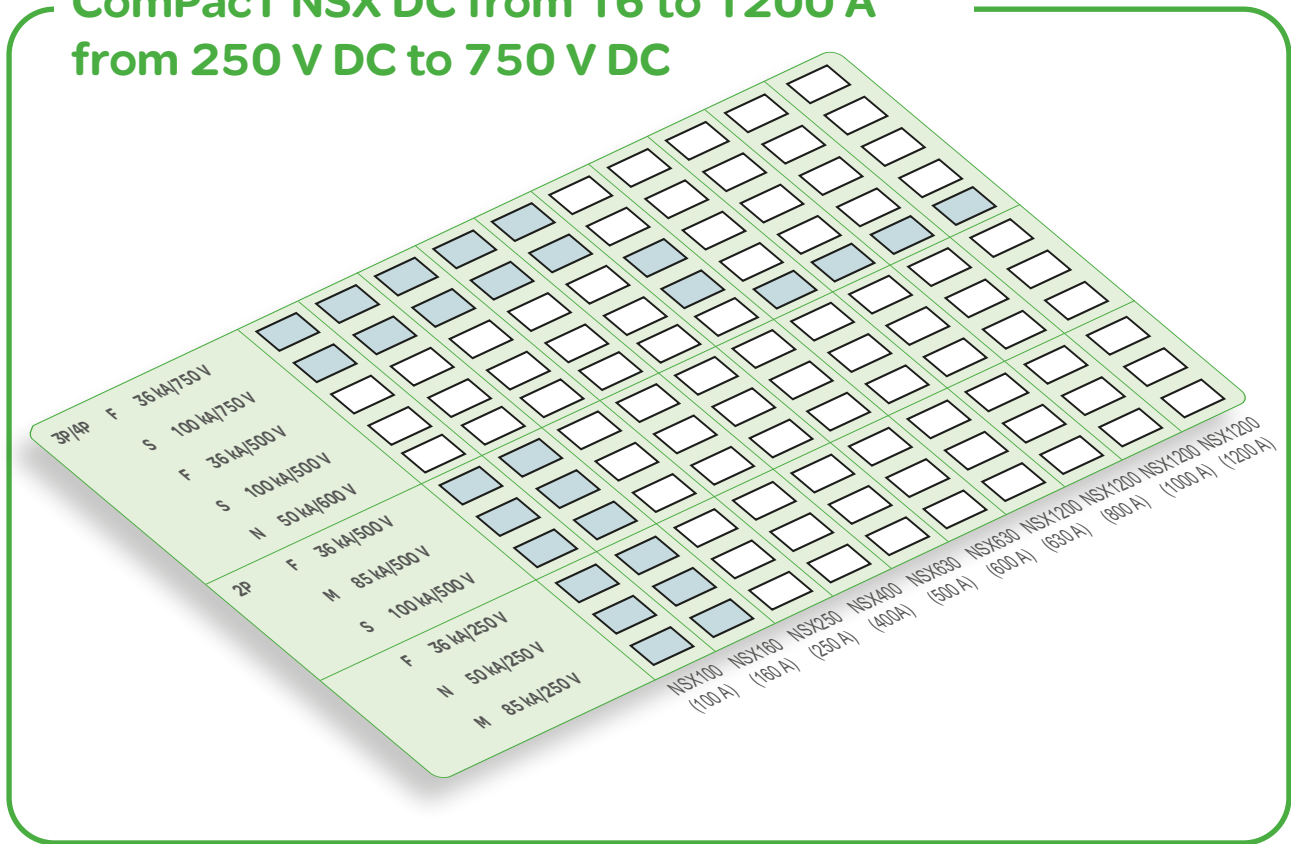

The ComPacT NSX range is designed for DC voltages from 24 to 750 V and offers:

- A wide selection of models suited to many applications:
  - 1, 2, 3 and 4 poles up to 160 A
  - 3 and 4 poles from 250 to 630 A
  - 2 poles from 630 to 1200 A
- High breaking capacities, with four performance levels F, N, M and S:
  - F
    - 36 kA in a 1 pole version, for systems  $\leq 250$  V
    - 36 kA in a 2 poles version, for systems  $\leq 500$  V
    - 36 kA in a 3 or 4 poles version, for systems  $\leq 750$  V
  - N
    - 50 kA in a 1 pole version, for systems  $\leq 250$  V
    - 50 kA in a 2 poles version, for systems  $\leq 600$  V
  - M
    - 85 kA in a 1 pole version, for systems  $\leq 250$  V
    - 85 kA in a 2 poles version, for systems  $\leq 500$  V

- S
  - 100 kA in a 2 poles version, for systems  $\leq 500$  V
  - 100 kA in a 3 or 4 poles version, for systems  $\leq 750$  V
- Fewer frame sizes: just two poles pitches (35 and 45 mm) for easy integration in installation systems (enclosures, machines, etc.)
- Accessories for insulation and series or parallel connection of poles, suited to the particularities of DC applications
- Fixed and withdrawable versions (3 and 4 poles, DC type).

**Breaking capacity Icu for 250 V per pole and L/R = 15 ms<sup>[1]</sup> (1P: 250 V, 2P: 500 V, 3P: 750 V)**

[1] L/R = time constant of the distribution system (see page A-11).



NSX1200 DC - 2P



NSX630 DC - 3P



NSX250 DC - 4P



NSX160 DC - 2P



NSX160 DC - 1P



# A Complete Molded Case Circuit Breaker DC Offer from 80 to 500 A

## ComPacT NSX DC PV from 80 to 500 A at 1000 V DC

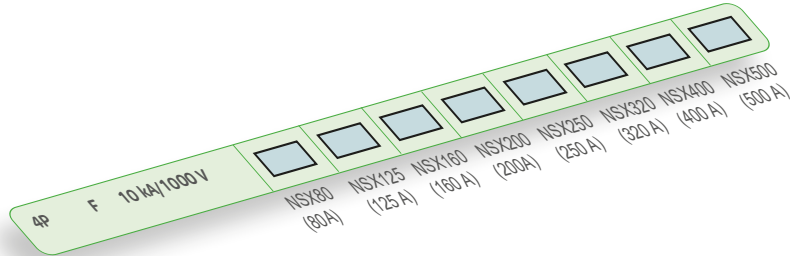

ComPacT NSX200 TM DC PV



The ComPacT NSX DC PV (Photovoltaic) range is designed for DC voltages under 1000 V and offers:

- Eight current ratings: 80, 125, 160, 200, 250, 320, 400 and 500 A
- A breaking-capacity level F: 10 kA for systems  $\leq$ 1000 V
- Two types of devices:
  - Circuit breaker for the protection of power circuits and loads
  - Switch-disconnector for circuit control and disconnection
- Fixed and withdrawable versions for the entire range
- Integrated protection: overload/short circuit protection with thermal magnetic.

## ComPacT NSX DC EP from 100 to 500 A at 1100 V DC and 1500 V DC

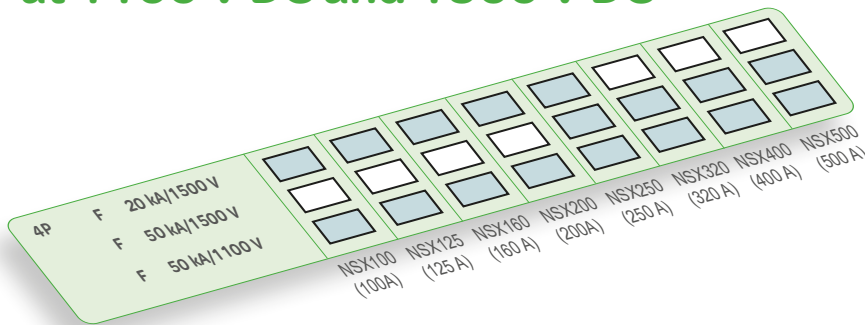

ComPacT NSX250 TM DC EP



The ComPacT NSX DC EP (Enhanced Performance) range is designed for DC voltages from 1100 to 1500 V and offers:

- Eight current ratings: 100, 125, 160, 200, 250, 320, 400 and 500 A
- Two high breaking-capacity level F:
  - 50 kA for systems  $\leq$ 1100 V
  - 50 kA for systems  $\leq$ 1500 V
  - 20 kA for systems  $\leq$ 1500 V
- Two types of devices:
  - Circuit breaker for the protection of power circuits and loads
  - Switch-disconnector for circuit control and disconnection
- Fixed and withdrawable versions for the entire range
- Integrated protection: Overload/short circuit protection with Thermal magnetic
- Dedicated to specific applications:
  - Photovoltaic application under 1500 V
  - Marine application under 1500 V are also presented in this catalog.



ComPacT NSX500 TM DC EP

# A Complete Air Circuit Breaker DC Offer from 16 to 4000 A

## MasterPact NW DC from 1000 to 4000 A

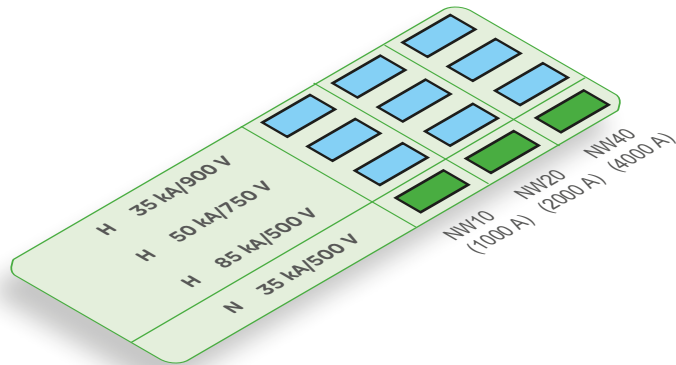

The MasterPact NW range is designed for DC voltages from 24 to 900 V and offers:

- 2 versions: C/D (3 poles)  
E (4 poles)
  - Three current ratings: 1000, 2000 and 4000 A
  - Two high breaking-capacity levels N and H.
- Breaking capacity  $I_{cu}$  for L/R = 15 ms<sup>[1]</sup> for 500, 750 or 900 V system voltages:
- N
    - 35 kA for systems  $\leq$  500 V
  - H
    - 85 kA for systems  $\leq$  500 V
    - 50 kA for systems  $\leq$  750 V
    - 35 kA for systems  $\leq$  900 V
  - Two types of devices:
    - Circuit breaker for the protection of power circuits and loads
    - Switch-disconnector for circuit control and disconnection
  - Fixed and drawout versions for the entire range.
  - Specific offers dedicated to the specific conditions of some applications:
    - NW HADC-D switch-disconnectors for photovoltaic application under 1000 V DC
    - NW EPDC-D circuit breakers for Marine application under 1100 V DC are also presented in this catalog.

[1] L/R = time constant of the distribution system (see page A-11).



NW10 DC - C/D Version

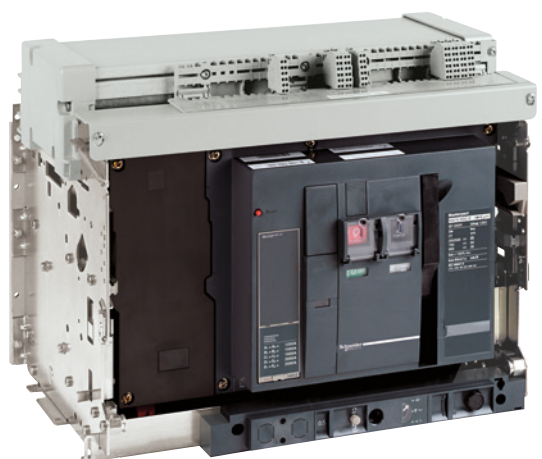

NW10 DC - E Version



# ComPacT NSX DC PV - DC EP, ComPacT INS PV and MasterPact NW DC PV

A Complete DC Offer for Solar  
Application from 80 to 4000 A



# ComPacT NSX DC PV - DC EP

## Circuit Breakers and Switch-Disconnectors

### Enhancing the Reliability and the Efficiency of your Photovoltaic Installation

Schneider Electric photovoltaic packages give you dependable, clean, and affordable solar power. High quality, highly efficient, and available everywhere, our systems are simple-to-install, giving you a competitive edge. The ComPacT NSX DC PV range of molded case circuit breakers and switch-disconnectors with operational voltage up to 1500 V DC includes the switchgears and the protection components you need to efficiently operate your photovoltaic installation in commercial buildings and power plants.



With heatsinks supplied as standard, the circuit breaker or switch-disconnector rating is optimized, avoiding the need to oversize protection components and saving space in the enclosure. As part of the ComPacT NSX range, all existing auxiliaries and accessories are compatible.

The terminal shields and phase barriers are available for insulation. The shunt trip auxiliary is available for remote disconnection.

#### ComPacT NSX DC PV - DC EP...

...with short heatsinks



...with long heatsinks





# ComPacT INS PV

## Switch-Disconnectors

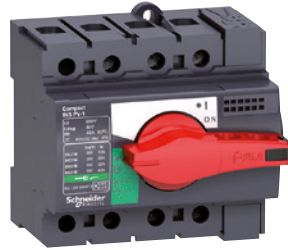

No matter the size or scale of the project, Schneider Electric, has a photovoltaic solution to fit your needs. Fast ROI, high efficiency – it's all a part of our offer as the world leader in energy management.

The INS PV-1 is a direct current switch disconnecter dedicated to array isolation and control with  $V_{oc}$  until 600 V DC.

## Photovoltaic Applications



# MasterPact NW HADCD-PV Switch-Disconnectors



Schneider Electric's MasterPact NW HADCD-PV switch-disconnectors are used for circuit control and disconnection.

## Dedicated to Photovoltaic Application





# MasterPact NW EPDC-D

## Circuit-Breakers for Marine Applications at 1100 V DC



Alternative energies have a major contribution to reducing the carbon footprint in marine industry and building the environmental sustainability of power generation.

Vessels hybrid propulsion systems have continuously been growing worldwide in these last years. The competitive environment together with the increasing power of such systems have created the need for voltage increase on the DC side, in order to limit the cables cross section, to lower the DC power losses, and to reduce the installation costs.

MasterPact NW10-40 EPDC-D is a 1100 V DC air circuit breakers offer tested and certified for marine application.

Marine applications have particular characteristics and require equipment with specific performance. These performance requirements are identified for the IEC 60947-2 products in the IACS UR E10 unified requirements: "Test Specification for marine Type Approval". NW10-40 EPDC-D circuit breakers are certified as per the IEC 60947-2 and the IACS UR E10.



# Architecture Overview

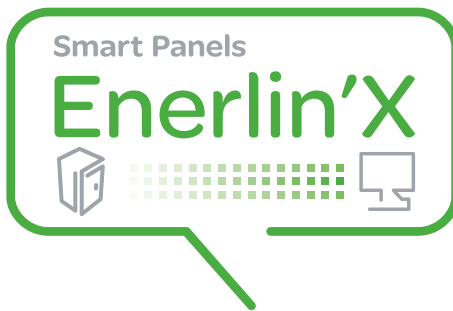

## Ethernet-Ready Smart Panels

Ethernet-ready Smart Panels enable electrical distribution control and expertise. 'Protect' - 'Measure' - 'Connect' are the 3 pillars of their technology.

PB115759.jpg



### 4- Act

### 3- Connect

#### Give a Voice to the Panel

Ethernet network data transmission is now part of the intrinsic design of protection and metering devices

### 2- Measure

#### Keeping a Close Eye on Energy Flows

The switchboard plays a key role in capturing building-related data, by gathering the critical protection and metering components.

### 1- Protect

#### Electrical Protection is at the Core of Smart Panel

High-performance technology is present in every breaker and every residual current device.

# Architecture Overview

## Future Savings, Peace-of-Mind

Access to Smart Panel status, values, is essential for taking advantages of monitoring and management services, locally or remotely.

### Act in Small/Medium Buildings

with FDM 128, Com'X 510, Power View, EcoStruxure™ Facility Expert



Electrical device monitoring and control with FDM 128, locally



#### Optimizing Energy-Efficiency

- Visualize, record energy consumption and WAGES.
- Comply with regulation.



Com'X 510 web pages direct display, or Cloud based pages from other devices with Power View



#### Improving Continuity of Service

- Get instant notifications
- Manage with assets-maintenance platform
- Get and analyze data for quick crisis-recovery



Distance management with EcoStruxure™ Facility Expert on Smartphone, tablet, PC



#### Increasing Maintenance Efficiency

- Operate preventive maintenance tools
- Follow maintenance & planning
- Provide business owner instant access to maintenance reports



# Architecture Overview

## Day-to-Day Energy Management >> Power Availability and Quality, Energy Performance

For simply dealing with building user's needs and energy constraints.

EcoStruxure™ Building Management provides electrical management, monitoring and energy accounting.

Energy decisions are often crucial in large critical buildings, they must be informed.

EcoStruxure™ Power Monitoring Expert (software for PC) collects Smart Panels values to provide expert analysis.

### Act in Large Non-Critical Buildings

with EcoStruxure™ Energy Expert



#### Managing Equipment and Key Assets

- Check operating status, faults on custom on-line diagrams.



#### Monitoring Electrical Network

- Observe voltage disturbances, harmonics on graphics.
- Read power factor.



#### Accounting Energy

- Record power meter data on dashboards.
- Allocate energy consumption with costs.
- Follow conservation goals.

### Act in Large Critical Buildings

with EcoStruxure™ Power Monitoring Expert [1]



#### Analyzing Power Events

- Speed up downtime crisis recovery.
- Determine incident root cause, events sequence.
- Troubleshoot power quality issues.



#### Monitoring Power quality

- Be alerted of equipment affected by power quality issue.
- Compare power quality against industry standards.
- Collect facts for future discussion with Utility.



#### Analyzing Energy Performance

- Evaluate building energy saving performance.
- Identify underperforming loads.
- Analyze Energy Conservation Measures (ECMs) according ISO50001 program.



[1] EcoStruxure™ Power Monitoring Expert, <https://pmedemo.biz/web/>  
ID: demo & Password: demo

# General Contents

Com**PacT** NSX DC - DC PV - DC EP  
Com**PacT** INS/INV DC - DC PV  
Master**Pact** NW DC - DC PV

Presentation

Functions and Characteristics

Installation Recommendations

Dimensions and Connection

Electrical Diagrams

Additional Characteristics

Catalog Numbers and Order Form

A

B

C

D

E

F

# The Benefits of a Comprehensive and Optimized Range Design...

ComPacT NSX and MasterPact NW DC - DC PV - DC EP circuit breakers constitute a flexible and cost-effective means to meet the various needs of DC systems.

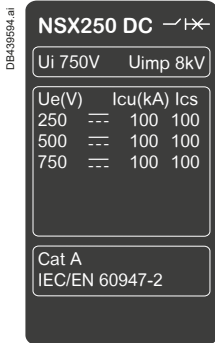

NSX250 DC rating plate

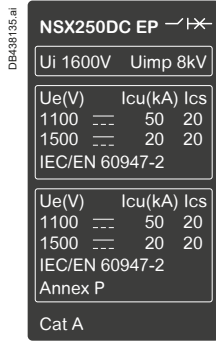

NSX250 DC EP rating plate

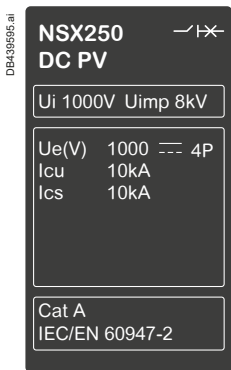

NSX250 DC PV rating plate

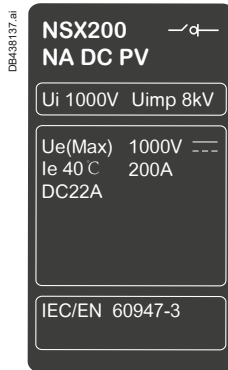

NSX200 NA DC PV rating plate

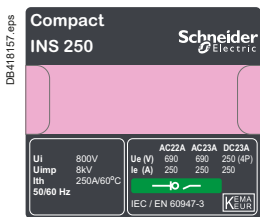

INS 250 rating plate

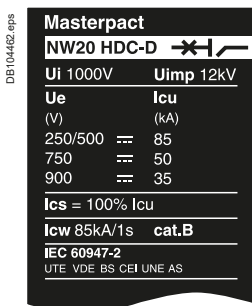

NW20 HDC-D rating plate

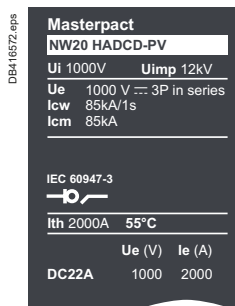

NW20 HADCD-PV rating plate

## A Wide, Complete and High-Performance Range

Schneider Electric DC- DC PV - DC EP circuit breakers and switches provide a comprehensive solution for the many applications met in DC systems. The ComPacT NSX and MasterPact NW DC ranges offer, a wide selection of current ratings (16 to 4000 A) and breaking capacities (up to 100 kA) for the common voltages up to 900 V DC. The ComPacT NSX and MasterPact NW DC - DC PV ranges are designed for use under 1000 V for photovoltaic application. The ComPacT INS/INV offers a wide selection of current ratings (40 to 2500 A) for the common voltage up to 250 V DC.

## Flexible and Optimized Design

The ComPacT NSX, ComPacT INS/INV and MasterPact NW DC ranges use all the standard accessories and auxiliaries of the AC ranges. The modular design and many possibilities offered by these systems provide a high degree of flexibility in customizing products, while benefiting from dependable and optimized industrial design.

## Dependable and Simple Operation

Even though they use the accessories of the corresponding AC ranges, the ComPacT NSX, ComPacT INS/INV and MasterPact NW DC ranges have been specially designed for DC systems. Specific accessories have been developed to meet the needs of series or parallel connection of poles by users in a simple and dependable manner (see page opposite). ComPacT NSX, ComPacT INS/INV and MasterPact NW DC devices can be installed in class II switchboards with a degree of protection up to IP54.

## Compliance with Standards

ComPacT NSX, ComPacT INS/INV and MasterPact DC circuit breaker ranges comply with:

- The main international standards and in particular IEC 60947-1/2/3
- European (EN 60947-1 and EN 60947-2) and the corresponding national standards: France NF, Germany VDE, UK BS, Australia AS, Italy CEI
- The specifications of the marine classification companies (Veritas, Lloyd's Register of Shipping, Det Norske Veritas, etc.)
- French standard NF C 79-130 and the recommendations issued by the CNOMO organization for the protection of machine tools. For United States UL, Canadian CSA, Mexican NOM and Japanese JIS standards, please consult us.

ComPacT NSX, ComPacT INS/INV and MasterPact NW DC - DC PV switches and auxiliaries comply with the following:

- The main international standards and in particular IEC 60947-2 (circuit breaker), IEC 60947-3 (switch-disconnectors)
- European (EN 60947-1, EN 60947-2 and EN 60947-3) and the corresponding national standards: France NF, Germany VDE, United Kingdom BS, Australia AS, Italy CEI.

## Open Communication

ComPacT NSX and MasterPact NW DC devices can be equipped with communication options for integration in a supervision system via Modbus.

## Pollution Degree

ComPacT NSX and MasterPact NW DC circuit breakers are certified for operation under pollution conditions in industrial environments, as per standard IEC 60947, corresponding to:

- Pollution degree 3 (ComPacT NSX, ComPacT INS/INV)
- Pollution degree 3 (MasterPact NW).

## Tropicalization

ComPacT NSX, ComPacT INS/INV and MasterPact NW DC circuit breakers have successfully passed the tests prescribed by the following standards for severe atmospheric conditions:

- IEC 60068-2-1 - dry cold (-40 °C)
- IEC 60068-2-1 - dry heat (+85 °C)
- IEC 60068-2-30 - damp heat (95 % relative humidity at +55 °C)
- IEC 68-2-52 (level 2) - salt mist.

## Environmental Protection

Schneider Electric circuit breaker ranges benefit from Eco-design:

- Use of environment-friendly materials
- Non-polluting production units complying with ISO 14001 standards
- Filtered breaking for high current ratings to avoid pollution in the switchboard
- Low dissipated energy per pole, making energy losses insignificant
- Marking of products in view of sorting recyclable materials at the end of the service life.



# ... Specifically for DC- DC PV - DC EP Applications

## Designed for Direct Current

### Performance Levels and Quality Signed Schneider Electric

The creation of a dependable and high-performance DC range requires a large amount of specific design and development work in addition to that invested in the original AC range.

Schneider Electric called on its proven industrial experience in the AC field and its recognized know-how in current interruption to develop a high-performance DC range.

Schneider Electric decided to use the cases and accessories of its ComPacT NSX and MasterPact NW ranges with:

- A high-performance design for the breaking chambers or the poles intended specifically for DC applications (e.g. 100 kA at 250 V per pole for ComPacT NSX and 85 kA at 900 V for two poles for MasterPact NW)
- Fast trip units developed for DC applications
- Optimized pole-connection and isolation possibilities that are both simple and dependable.

### Optimized Solutions for the Many Types of DC Systems

The many types of DC systems make it necessary, for cost and technical-optimization reasons, to connect the poles of two, three or four-pole circuit breakers in series or in parallel.

The ComPacT NSX and MasterPact NW ranges enable series connection of poles, thereby optimizing breaking capacity for high voltages.

Series connection reduces the voltage across the terminals of each pole (the total voltage is divided by two, three or four depending on the circuit breaker) and the operation of all poles provides the breaking capacity of the overall device.

This makes it possible to break short-circuit currents at high voltages while optimizing solutions (e.g. a ComPacT NSX 100 kA 250 V per pole can be used on a 750 V system with three compared to a 750 V solution).

The ComPacT NSX range enables parallel connection of the poles, thereby optimizing the use of the rated currents.

## Optimized and Dependable Series or Parallel Connection of Poles

### Series Connection - Controlled Temperature Rise and Enhanced Performance

Schneider Electric DC circuit breakers comply with product standards IEC 60947-1 and 2.

To that end, series connection of poles meets:

- Temperature-rise conditions. Connections specifically designed to dissipate heat mean the thermal model is equivalent to that for AC applications. The devices dissipate the temperature rise produced by relatively short series connections.
- Connections are designed for severe operating conditions (insulation and safety clearances, ultimate breaking capacity, high pollution levels, etc.).

### Parallel Connection - Optimization

Certain DC systems require high power levels (hundreds to thousands of amperes) at reduced voltages, most often  $\leq 250$  V.

The configurations of DC systems and the exceptional performance levels of ComPacT NSX circuit breakers mean the poles can be parallel connected.

This technique virtually doubles, triples or quadruples the current rating depending on the type of circuit breaker and thus reduces the cost of solutions.

ComPacT NSX DC and MasterPact NW DC circuit breakers offer optimized pole-connection possibilities.

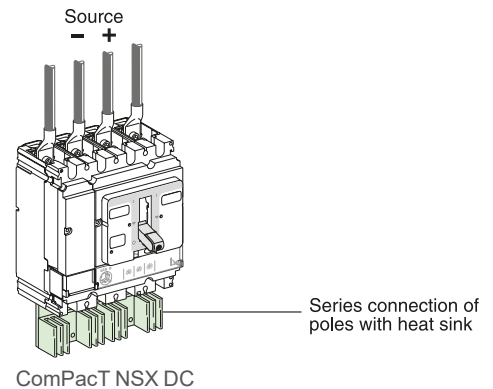

DB43776.ai

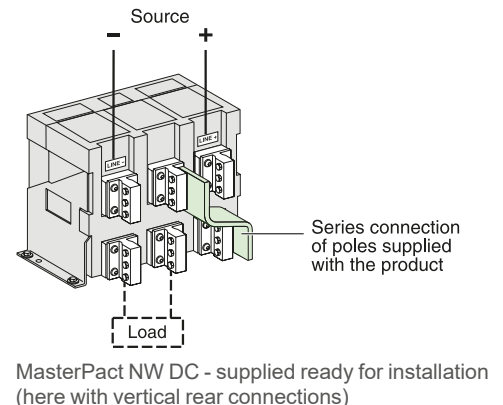

DB430776.eps

# Great Flexibility in Adapting to DC Applications

## Overview of Series Connection of Poles for ComPacT NSX DC

With ComPacT NSX DC circuit breakers, it is easy to create a large number of series pole arrangements using prefabricated connections mounted on site during equipment installation.

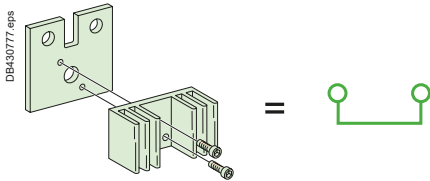

One type of connection per framesize, two catalog numbers for all series connections.

### ComPacT NSX DC

#### Examples of Series Connection

##### Two-pole devices

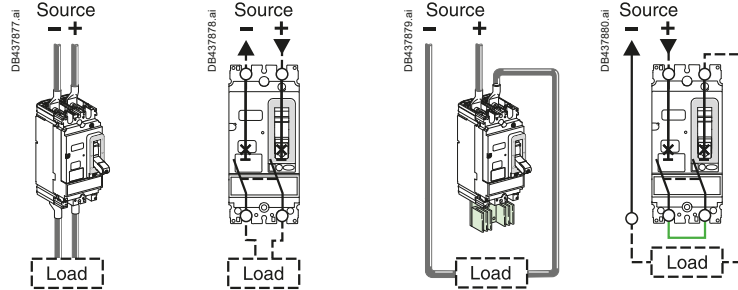

##### Three-pole devices

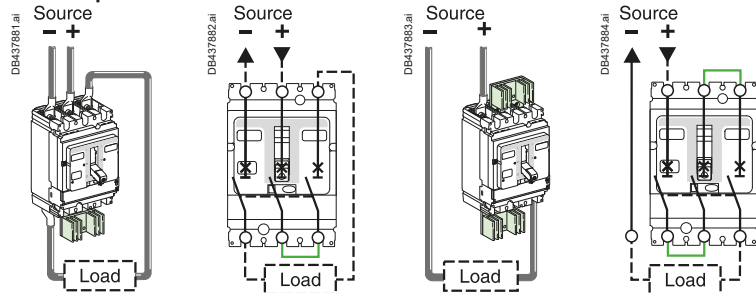

##### Four-pole devices

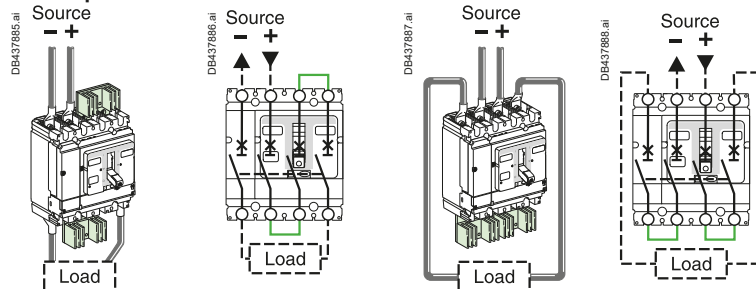

- All connections are possible for the fixed and withdrawable versions
- Indifferent connection of polarities, from left to right or right to left
- Indifferent connection of upstream and downstream cables to top or bottom terminals
- Series connection of poles is possible by upstream/downstream connections. Creation of the connections is the responsibility of the panel builder or the installer.

#### Great Flexibility for Connections

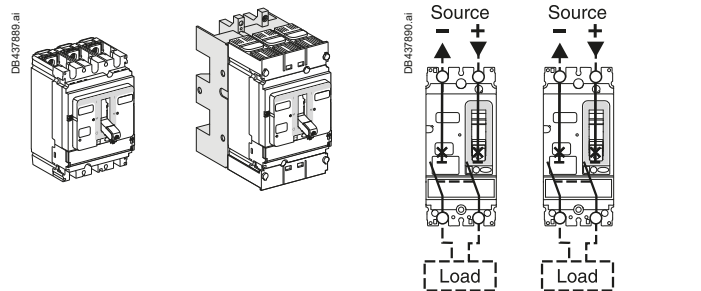

All connections are possible for the fixed and withdrawable versions

Indifferent connection of polarities

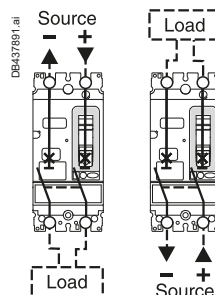

Upstream/downstream connections to top or bottom connectors

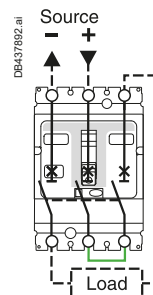

Series connection of poles is possible by upstream/downstream connections (user made)

# Great Flexibility in Adapting to DC Applications

## Overview of Series Connection of Poles for ComPacT INS/INV

With ComPacT INS/INV switch-disconnectors, it is easy to create a large number of series pole arrangements using prefabricated connections mounted on site during equipment installation.

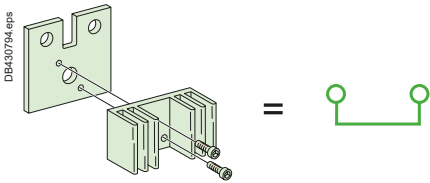

One type of connection per frame size, two catalog numbers for all series connections.

### Series Connection of Poles for Direct Current Applications

#### Examples of Series Connection

##### Three-pole devices

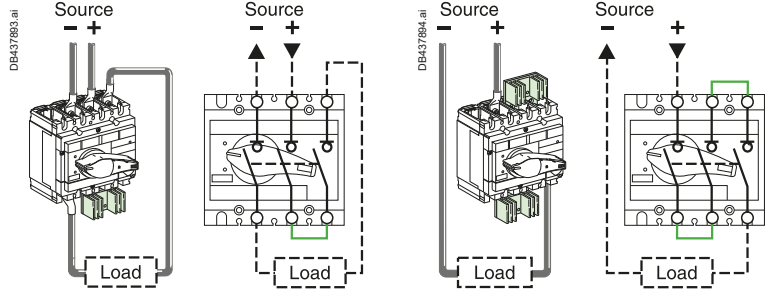

##### Four-pole devices

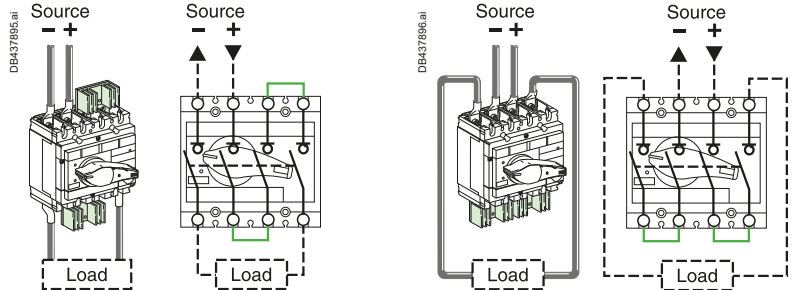

- Indifferent connection of polarities, from left to right or right to left
- Indifferent connection of upstream and downstream cables to top or bottom terminals
- Series connection of poles is possible by upstream/downstream connections. Creation of the connections is the responsibility of the panel builder or the installer.

#### Great Flexibility for Connections

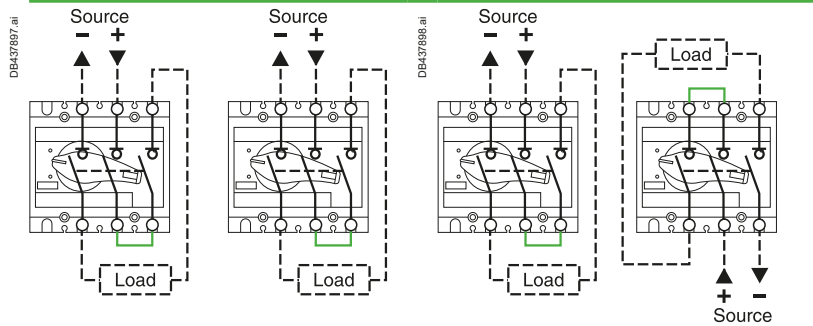

Indifferent connection of polarities

Upstream/downstream connections to top or bottom connectors

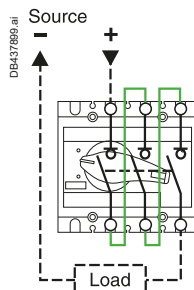

Series connection of poles is possible by upstream/downstream connections (user made)



# Great Flexibility in Adapting to DC Applications

## Overview of Series Connection of Poles for MasterPact NW DC

MasterPact NW DC circuit breakers, with high ratings and installed as incoming devices, offer three coupling versions C, D and E ready for connection. The polarities "Line -", "Line +" indicated on the rear connections of the MasterPact NW DC circuit breakers have to be respected in order to match the magnetic threshold tolerances.

### MasterPact NW DC

#### Three Versions Supplied Ready for Connection

##### Version C

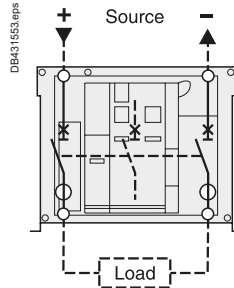

Front view: three-pole case - two poles in series

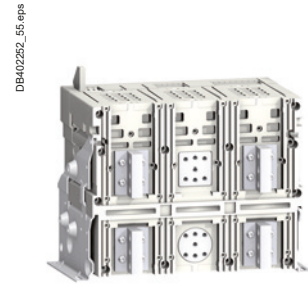

Rear view

The prefabricated series connections are factory made due to the power ratings. They also dissipate heat.

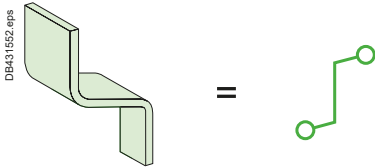

##### Version D

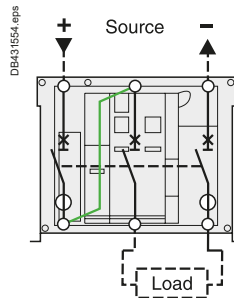

Front view: three-pole case - three poles in series

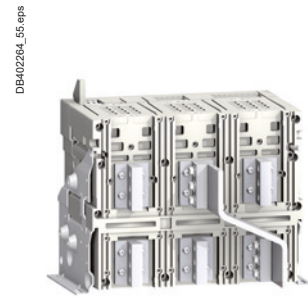

Rear view with connections

##### Version E

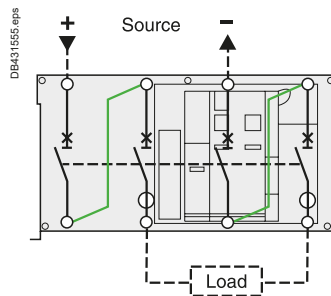

Front view: four-pole case - four poles in series

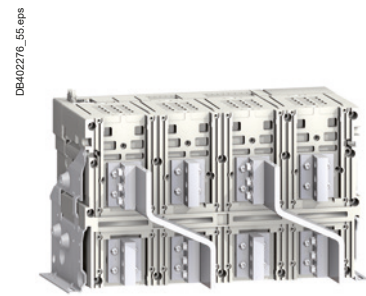

Rear view with connections

# Great Flexibility in Adapting to DC Applications

## Parallel Connection of Poles

The exceptional performance levels of ComPacT NSX DC, DC PV and DC EP circuit breakers mean the poles can be parallel connected. This technique virtually doubles, triples or quadruples the current rating depending on the type of circuit breaker and thus reduces the cost of solutions.

### Examples of Parallel Connection

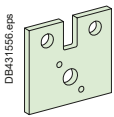

Parallel pole connection accessories are identical to those for series connections. They are equipped with heat sinks. Customer connections are made directly to the connection plates after removing the heat sinks.

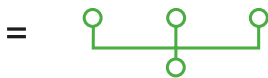
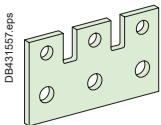

Specific connections are required for parallel connection of three poles.

#### Two-pole devices

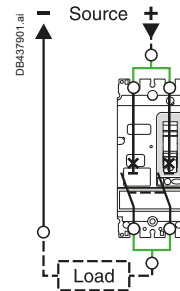
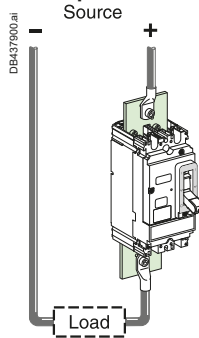

#### Three-pole devices

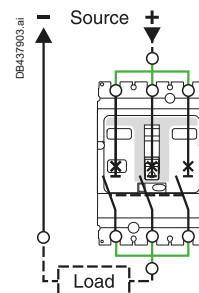
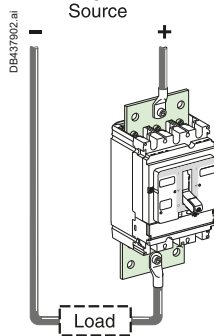

#### Four-pole devices (2 x 2 poles in parallel)

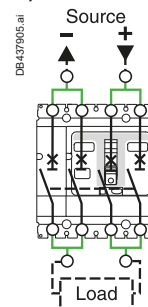
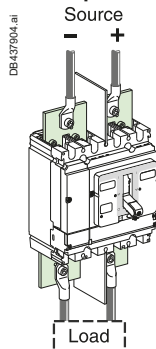

### It Is Possible to Mix Series and Parallel Connections

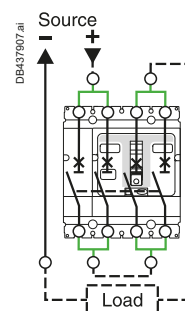
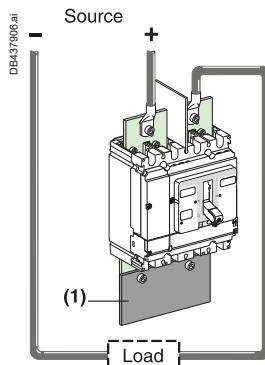

**Note:** Creation of the additional connection [1] is the responsibility of the panel builder or the installer.

Presentation

# Great Flexibility in Adapting to DC EP Applications

## Overview of Series Connectors for NSX DC EP

### ComPacT NSX TM DC EP

### ComPacT NSX NA DC EP

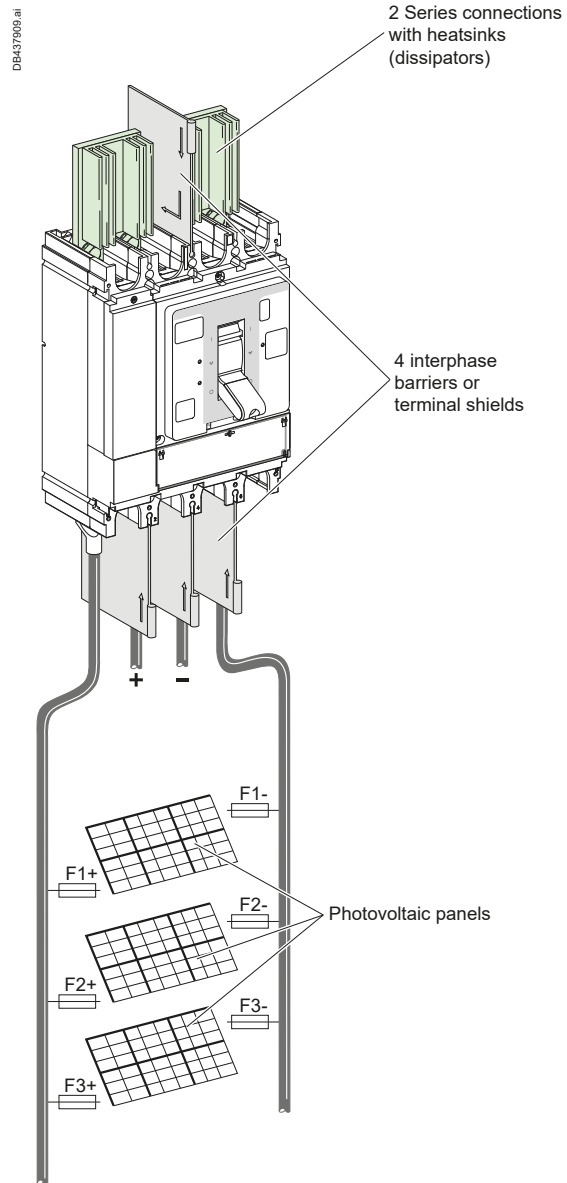
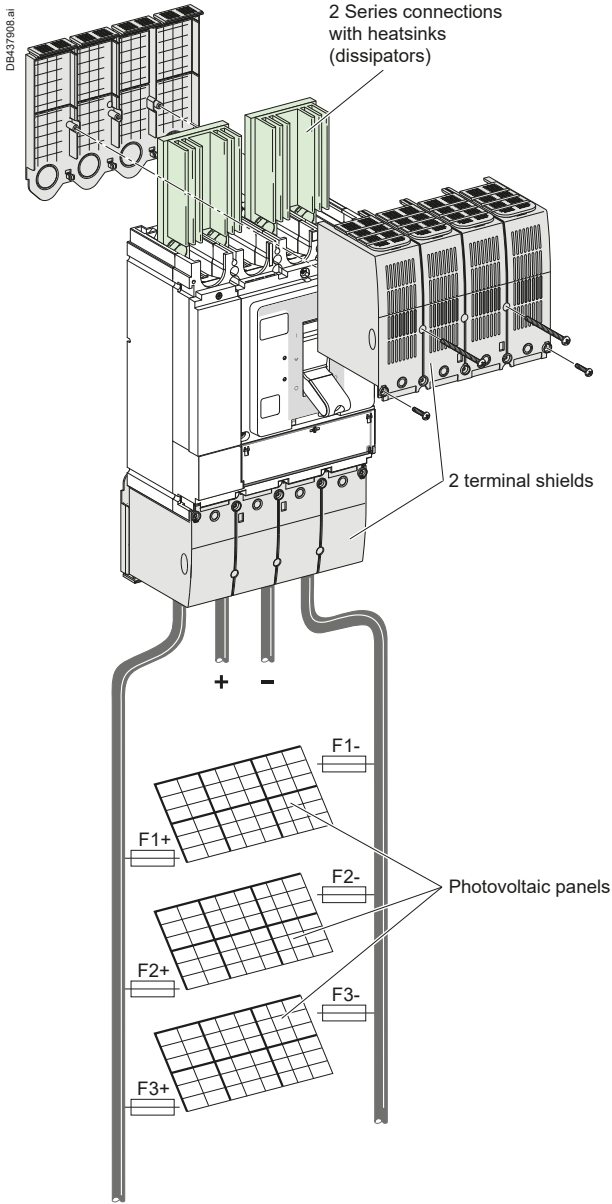



# Great Flexibility in Adapting to DC EP Applications

## Overview of Series Connectors for NSX DC EP

### ComPacT NSX100 to NSX250 DC EP/ComPacT NSX100 to NSX250 NA DC EP

	A	B	C	D
PV L/R ≤ 2 ms	●	●	●	●
Marine L/R > 2 ms	-	●	●	-

DB438106.ai

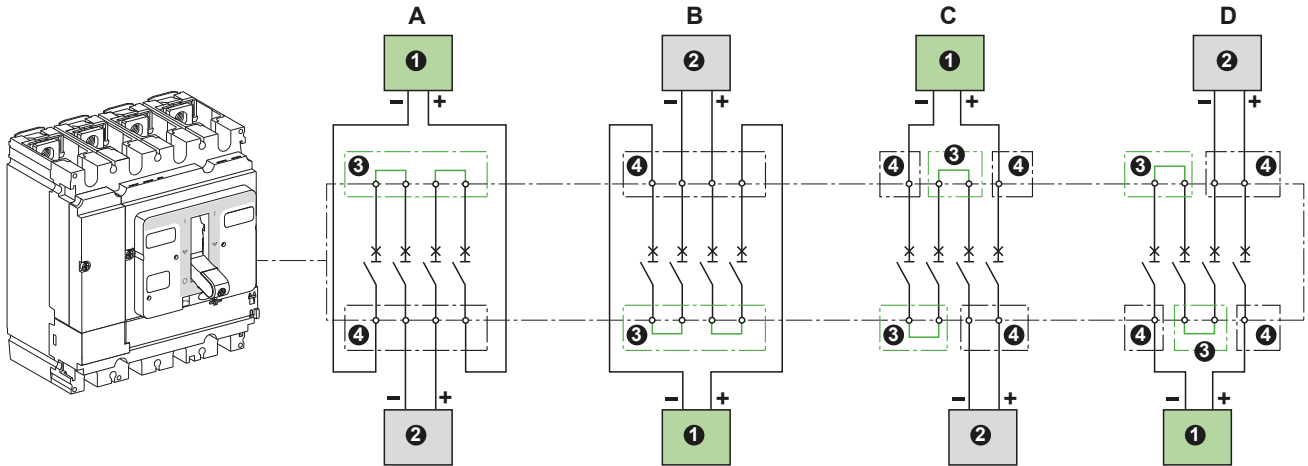

- 1 Source
- 2 Load
- 3 Series connections with heatsinks
- 4 Terminal shields

> ComPacT NSX250 TM DC EP and ComPacT NSX250 NA DC EP Detailed Guide



### ComPacT NSX250 to NSX500 DC EP/ComPacT NSX320 to NSX630 NA DC EP

	A	B	C	D
PV L/R ≤ 2 ms	●	●	●	●
Marine L/R > 2 ms	●	●	●	●

DB438107.ai

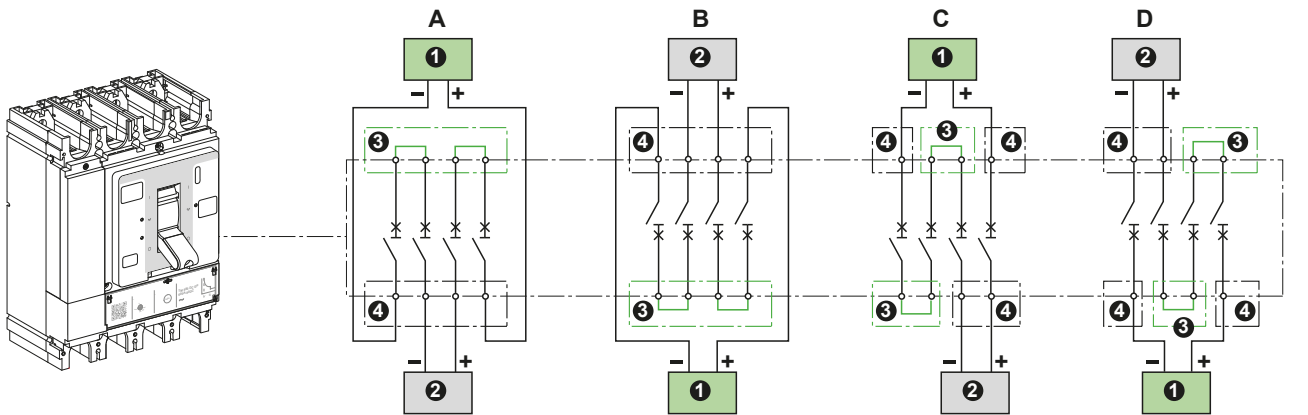

- 1 Source
- 2 Load
- 3 Series connections with heatsinks
- 4 Terminal shields

> ComPacT NSX500 TM DC EP and ComPacT NSX630 NA DC EP Detailed Guide



# Connection Accessories

The exceptional performance levels of ComPacT INS/INV switch-disconnectors mean the poles can be parallel connected. This technique virtually doubles, triples or quadruples the current rating depending on the type of circuit breaker and thus reduces the cost of solutions.

## Parallel Connection of Poles for Direct Current Applications

### Examples of Parallel Connection

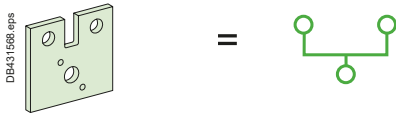

Parallel pole connection accessories are identical to those for series connections. They are equipped with heat sinks.

Customer connections are made directly to the connection plates after removing the heat sinks.



Specific connections are required for parallel connection of three poles.

#### Three-pole devices

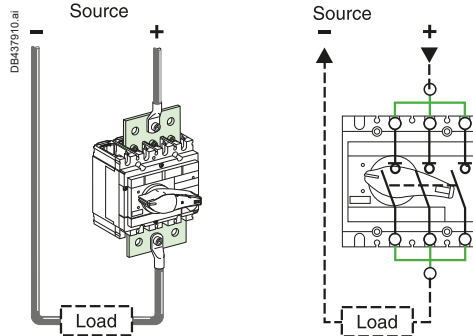

#### Four-pole devices (2 x 2 poles in parallel)

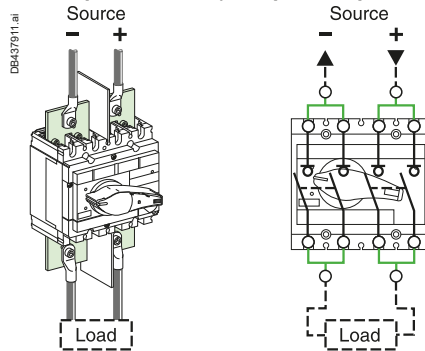

### It Is Possible to Mix Series and Parallel Connections

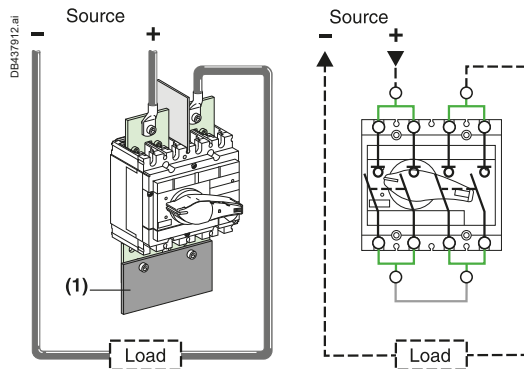

**Note:** Creation of the additional connection [1] is the responsibility of the panel builder or the installer.

#### Great flexibility for connections

- Indifferent connection of polarities, from left to right or right to left.
- Indifferent connection of upstream and downstream cables to top or bottom terminals.

# Functions and Characteristics

**Selection Guide for DC Circuit Breakers**  
Types of DC Distribution Systems..... A-4  
Solutions Depending on the Distribution System and the Voltage . A-5  
Examples of Circuit Breaker Selection..... A-8

**Connection Accessories.....A-9**

**Selection Guide for DC Circuit Breakers**  
Examples of Circuit Breaker Selection..... A-10

**Calculation of DC Distribution-System Characteristics**  
Short-Circuit Currents L/R Time Constant..... A-11

**General Characteristics of ComPacT NSX DC, DC PV and DC EP**  
Operating Conditions..... A-12  
ComPacT NSX DC and DC PV..... A-13

**Circuit Breaker Characteristics**  
ComPacT NSX100 DC to NSX250 DC ..... A-14  
ComPacT NSX400 DC to NSX1200 DC ..... A-16

**Trip Unit Characteristics**  
Types of Trip Units - Trip Units for ComPacT NSX DC ..... A-18  
Characteristics and Performance of ComPacT NSX  
Switch-Disconnectors from 100 to 250 NA ..... A-20

**Switch-Disconnectors Characteristics**  
ComPacT NSX400/630 NA DC..... A-22

**Accessories and Auxiliaries**  
Overview of ComPacT NSX100 to 630 DC [\*] Fixed Version..... A-24  
Overview of ComPacT NSX1200 DC Fixed Version ..... A-26  
Overview of ComPacT NSX100 to 630 DC [†] Plug-in  
and Withdrawable Versions ..... A-28

**Electrical and Mechanical Accessories**  
ComPacT NSX100 to 1200 DC..... A-30  
Connection of Fixed Devices ..... A-32  
Connection of Electrical Auxiliaries ..... A-34  
Selection of Auxiliaries for ComPacT NSX100/160/250 DC..... A-36  
Selection of Auxiliaries for ComPacT NSX400/630/1200 DC..... A-38  
Indication Contacts for ComPacT NSX DC ..... A-39  
Rotary Handles for ComPacT NSX DC..... A-40  
Motor Mechanism for ComPacT NSX DC..... A-42  
Remote Tripping for ComPacT NSX DC ..... A-43  
Locks for ComPacT NSX DC ..... A-44  
Sealing Accessories for ComPacT NSX DC..... A-45  
Escutcheons and Protection Collars for ComPacT NSX DC..... A-46



**Other Chapters**  
Presentation .....2  
Installation Recommendations..... B-1  
Dimensions and Connection ..... C-1  
Electrical Diagrams..... D-1  
Additional Characteristics..... E-1  
Catalog Numbers and Order Form ..... F-1

## Functions and Characteristics

### TransferPacT Source-Changeover Systems

Presentation .....	A-48
Manual Source-Changeover Systems .....	A-49

### Circuit Breaker Characteristics

ComPacT NSX80 TM DC PV to NSX500 TM DC PV .....	A-50
ComPacT NSX100 TM DC EP to NSX500 TM DC EP .....	A-52

### Switch-Disconnectors Characteristics

ComPacT NSX100 NA DC PV to NSX500 NA DC PV .....	A-54
ComPacT NSX630b NA DC PV to NSX1600 NA DC PV .....	A-56
ComPacT NSX100 NA DC EP to NSX630 NA DC EP .....	A-58

### Accessories and Auxiliaries

Overview of ComPacT NSX80 TM to NSX500 TM DC PV - Circuit Breakers .....	A-60
Overview of ComPacT NSX100 NA to NSX500 NA DC PV - Switch-Disconnectors .....	A-61

### Accessories and Auxiliaries

Overview of ComPacT NSX100 TM to NSX250 TM DC EP - ComPacT NSX100 NA to NSX250 NA DC EP Circuit Breakers and Switch-Disconnectors .....	A-62
Overview of ComPacT NSX250 TM to NSX500 TM DC EP - ComPacT NSX320 NA to NSX630 NA DC EP Circuit Breakers and Switch-Disconnectors .....	A-63
Overview of ComPacT NSX630b NA to NSX1600 NA DC PV Switch-Disconnectors .....	A-64

### ComPacT INS DC PV..... A-65

### Switch-Disconnecter Selection

ComPacT INS40 to 160 DC .....	A-66
ComPacT INS250-100 to 630 DC .....	A-70
ComPacT INS630b to 2500 DC .....	A-74
ComPacT INV100 to 630 DC .....	A-78
ComPacT INV630b to 2500 DC .....	A-82

### Communication

Enerlin'X Digital System - Overview .....	A-86
IFE Ethernet Interface .....	A-88
IFM Modbus Communication Interface .....	A-90
COM Option in ComPacT and MasterPact .....	A-91
I/O Application Module .....	A-92
Communications Modules, IFM and IFE for ComPacT NSX .....	A-94
Communication Components and Connections .....	A-95
Connection of the IFE to a Fixed or Drawout MasterPact NW .....	A-96
Connection of the IFM to a Fixed or Drawout MasterPact NW .....	A-97
Electrical Asset Manager Configuration Engineering Tool .....	A-98

#### Other Chapters

Presentation .....	2
Installation Recommendations .....	B-1
Dimensions and Connection .....	C-1
Electrical Diagrams .....	D-1
Additional Characteristics .....	E-1
Catalog Numbers and Order Form .....	F-1

A



# Functions and Characteristics

**General Characteristics of MasterPact NW DC, EPDC, DC PV**  
 Operating Conditions..... A-100  
 MasterPact NW10 to NW40 DC..... A-102

**Trip Unit Characteristics**  
 Trip Units for MasterPact NW DC, EPDC..... A-104

**Switch-Disconnectors for PV Application**  
 MasterPact NW HADCD-PV ..... A-106  
 MasterPact NW HADCD-PV -  
 Connections and Safety Clearances..... A-107

**MasterPact NW EPDC-D Circuit Breakers for Marine Applications at 1100 V DC ..... A-108**

**Panorama of Electrical and Mechanical Accessories**  
 MasterPact NW10 to NW40 DC..... A-110

**Connection**  
 Overview of Solutions..... A-112

**Electrical and Mechanical Accessories**  
 MasterPact NW10 to NW40 DC..... A-114



**Other Chapters**

Presentation .....2  
 Installation Recommendations..... B-1  
 Dimensions and Connection ..... C-1  
 Electrical Diagrams..... D-1  
 Additional Characteristics..... E-1  
 Catalog Numbers and Order Form ..... F-1

# Selection Guide for DC Circuit Breakers

## Types of DC Distribution Systems

There are three types of DC distribution systems (see the table).  
The operational voltage in conjunction with one of the three systems determines the number of poles taking part in current interruption.

Selection of a circuit breaker depends essentially on the distribution-system parameters presented below which are used to determine the corresponding characteristics:

- Type of system - determines the type of product and the number of poles connected in series for each polarity
- Rated voltage - determines the number of series poles taking part in current interruption
- Nominal current - determines the rated current of the circuit breaker
- Maximum short-circuit current at the point of installation - determines the breaking capacity.

### Types of systems

	Earthed systems		Isolated systems
	The source has one earthed polarity <sup>[1]</sup>	The source has an earthed mid-point	
<b>Diagrams and different faults</b>			
<b>Fault analysis (neglecting resistance of earth electrodes)</b>			
<b>Fault A</b>	<ul style="list-style-type: none"> <li>■ Maximum I<sub>sc</sub> at U</li> <li>■ Only protected polarity concerned</li> <li>■ All poles of protected polarity must have breaking capacity ≥ I<sub>sc</sub> max. at U</li> </ul>	<ul style="list-style-type: none"> <li>■ Maximum I<sub>sc</sub> at U/2</li> <li>■ Only positive polarity concerned</li> <li>■ All poles of positive polarity must have breaking capacity ≥ I<sub>sc</sub> max. at U/2</li> </ul>	<ul style="list-style-type: none"> <li>■ No consequences</li> <li>■ The fault must be indicated by an IMD (insulation-monitoring device) and cleared (standard IEC/EN 60364)</li> </ul>
<b>Fault B</b>	<ul style="list-style-type: none"> <li>■ Maximum I<sub>sc</sub> at U</li> <li>■ If only one polarity (the positive here) is protected, all poles of protected polarity must have breaking capacity ≥ I<sub>sc</sub> max. at U</li> <li>■ If both polarities are protected, to enable disconnection, all poles of the two polarities must have breaking capacity ≥ I<sub>sc</sub> max. at U</li> </ul>	<ul style="list-style-type: none"> <li>■ Maximum I<sub>sc</sub> at U</li> <li>■ Both polarities are concerned</li> <li>■ All poles of the two polarities must have breaking capacity ≥ I<sub>sc</sub> max. at U</li> </ul>	<ul style="list-style-type: none"> <li>■ Maximum I<sub>sc</sub> at U</li> <li>■ Both polarities are concerned</li> <li>■ All poles of the two polarities must have breaking capacity ≥ I<sub>sc</sub> max. at U</li> </ul>
<b>Fault C</b>	No consequences	<ul style="list-style-type: none"> <li>■ Same as fault A</li> <li>■ All poles of the Negative polarity must have breaking capacity ≥ I<sub>sc</sub> max. at U/2</li> </ul>	<ul style="list-style-type: none"> <li>■ Same as fault A with the same actions</li> </ul>
<b>Double fault A and D or C and E</b>	Double fault not possible, system trips on first fault	Double fault not possible, system trips on first fault	<ul style="list-style-type: none"> <li>■ Maximum I<sub>sc</sub> at U</li> <li>■ Only positive polarity (cases A and D) or negative (C and E) concerned</li> <li>■ All poles of each polarity must have breaking capacity ≥ I<sub>sc</sub> max. at U</li> </ul>
<b>Most unfavorable cases</b>	Fault A and fault B (if only one polarity is protected)	Fault B	Double fault A and D or C and E
<b>Conclusion: selection of number of poles and breaking capacity</b>			
<b>Layout of protection poles</b>			
	<ul style="list-style-type: none"> <li>■ On only one polarity<sup>[1]</sup></li> </ul>	<ul style="list-style-type: none"> <li>■ Identical for each polarity</li> </ul>	<ul style="list-style-type: none"> <li>■ Identical for each polarity</li> </ul>
<b>Number of series poles</b>			
Per polarity	<ul style="list-style-type: none"> <li>■ All on same polarity</li> </ul>	<ul style="list-style-type: none"> <li>■ Equal</li> </ul>	<ul style="list-style-type: none"> <li>■ Equal</li> </ul>
Total	<ul style="list-style-type: none"> <li>■ 1, 2 or 3 without disconnection</li> <li>■ 2, 3 or 4 with disconnection</li> </ul>	<ul style="list-style-type: none"> <li>■ 2 or 4<sup>[2]</sup></li> </ul>	<ul style="list-style-type: none"> <li>■ 2 or 4<sup>[2]</sup></li> </ul>
<b>Breaking capacity</b>			
	<ul style="list-style-type: none"> <li>■ All poles of the protected polarity ≥ I<sub>sc</sub> max. at U</li> </ul>	<ul style="list-style-type: none"> <li>■ All poles of both polarities ≥ I<sub>sc</sub> max. at U</li> <li>■ All poles of each polarity ≥ I<sub>sc</sub> max. at U/2</li> </ul>	<ul style="list-style-type: none"> <li>■ All poles of each polarity ≥ I<sub>sc</sub> max. at U</li> </ul>
<b>Disconnection of both polarities<sup>[3]</sup></b>			
	Possible by adding a pole to the non-protected polarity	<ul style="list-style-type: none"> <li>■ Ensured</li> </ul>	<ul style="list-style-type: none"> <li>■ Ensured</li> </ul>
<b>Implementation</b>			
	See the selection table opposite		

[1] Positive or negative, depending on the polarity connected to the exposed conductive parts.

[2] A 3P circuit breaker can be used if a 2P version does not exist. In this case, the central pole is not connected.

[3] Disconnection made possible by multi-pole breaking.

# Selection Guide for DC Circuit Breakers

Solutions Depending on the Distribution System and the Voltage

## Series Connection of Poles

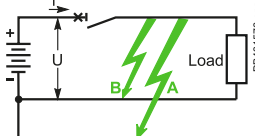
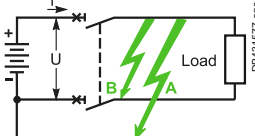
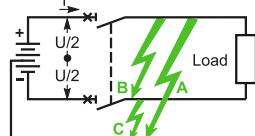
Type of distribution system			
<b>Type</b>	<b>Earthed</b>		<b>Isolated</b>
<b>Source</b>	One polarity (negative here) connected to earth (or exposed conductive parts)		Mid-point connected to earth
<b>Protected polarities</b>	1 (disconnection of 1P)	2 (disconnection of 2P)	2
<b>Diagrams (and types of faults)</b>			

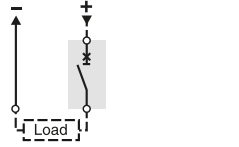
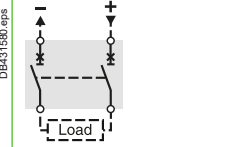
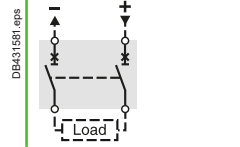
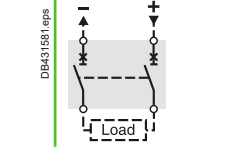
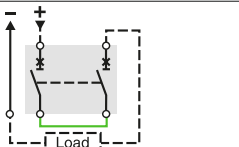
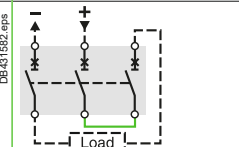
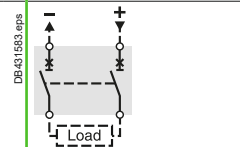
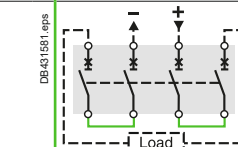
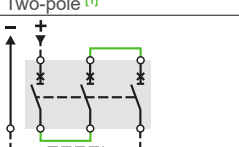
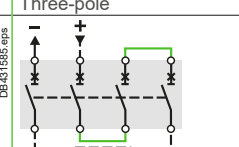
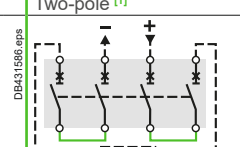
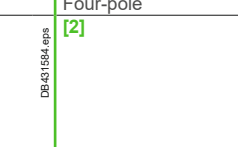
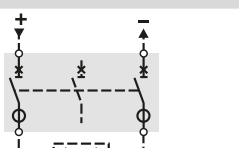
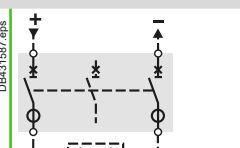
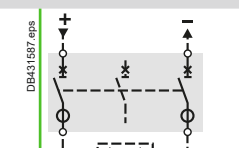
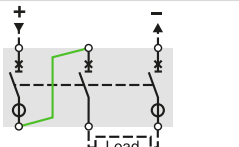
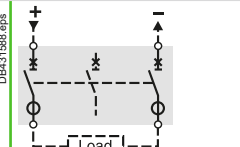
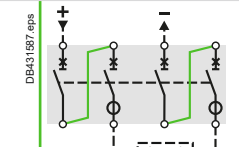
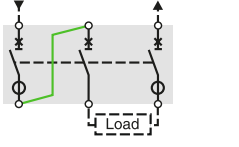
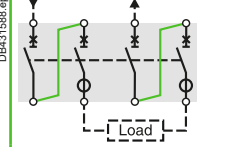
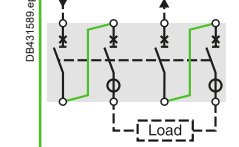
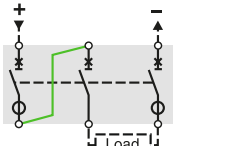
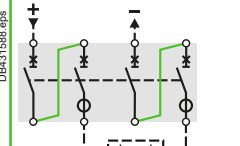
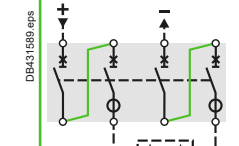

## Selection of circuit breaker and pole connection

ComPacT NSX DC				
<b>24 V ≤ Un ≤ 250 V</b>	 Single-pole	 Two-pole <sup>[1]</sup>	 Two-pole <sup>[1]</sup>	 Two-pole <sup>[1]</sup>
<b>250 V &lt; Un ≤ 500 V</b>	 Two-pole <sup>[1]</sup>	 Three-pole	 Two-pole <sup>[1]</sup>	 Four-pole
<b>500 V &lt; Un ≤ 750 V</b>	 Three-pole	 Four-pole	 Four-pole	 Four-pole <sup>[2]</sup>
MasterPact NW DC				
<b>Type N</b>				
<b>24 V ≤ Un ≤ 500 V</b>		 Version C	 Version C	 Version C
<b>Type H</b>				
<b>24 V ≤ Un ≤ 500 V</b>		 Version D	 Version C	 Version E
<b>500 V &lt; Un ≤ 750 V</b>		 Version D	 Version E	 Version E
<b>750 V &lt; Un ≤ 900 V</b>		 Version D	 Version E	 Version E

[1] A 3P circuit breaker can be used if a 2P version does not exist. In this case, the central pole is not connected.  
 [2] ComPacT NSX DC circuit breakers (and switch disconnectors) are designed to break the rated current or fault current at the rated operational voltage (Ue) with all poles. To break the current at voltage > 500 V, three poles in series are required. In double earth fault situations (A + D or C + E), the circuit breaker (and Switch disconnectors) must break the current at full voltage with only half of the poles. ComPacT NSX DC circuit breakers (and Switch disconnectors) are not designed for this purpose and could sustain irremediable damage if used to break the current in a double earth fault situation for voltage > 500 V.



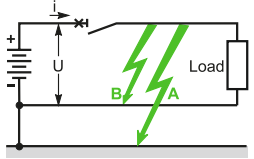
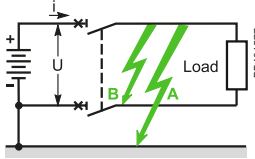
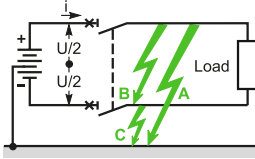

# Selection Guide for DC Circuit Breakers

## Solutions Depending on the Distribution System and the Voltage

### Parallel Connection of Poles

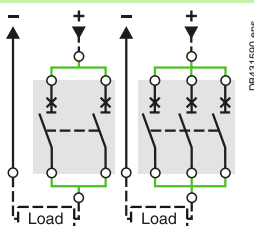
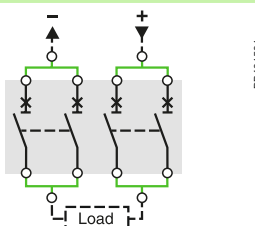
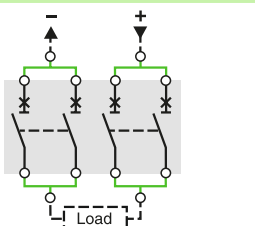
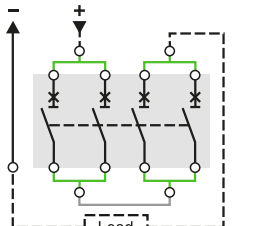
Type of distribution system			
Type	Earthed		Isolated
Source	One polarity (negative here) connected to earth (or exposed conductive parts)		Mid-point connected to earth
Protected polarities	1 (disconnection of 1P)	2 (disconnection of 2P)	2
Diagrams (and types of faults)			

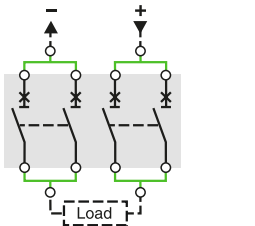
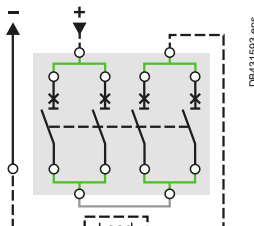
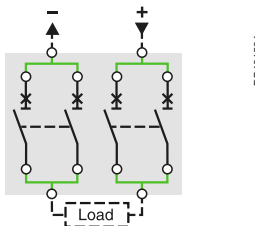
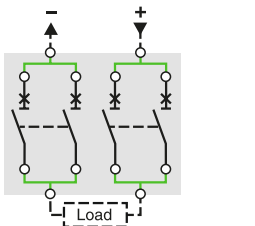
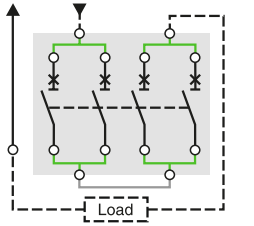
### Selection of circuit breaker and pole connection

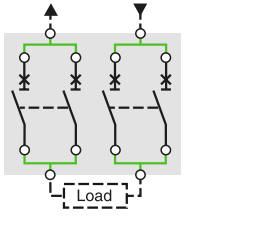
ComPacT NSX DC			
$U_n \leq 250\text{ V}$	 Two, three-pole, 2, 3P in parallel, four-pole, 4P in parallel	 Four-pole, 2 x 2P in parallel	 Four-pole, 2 x 2P in parallel
$250\text{ V} < U_n \leq 500\text{ V}$	 Four-pole, 2 x 2P in parallel, connected in series	 Four-pole, 2 x 2P in parallel	 Four-pole, 2 x 2P in parallel
<b>ComPacT NSX1200 DC [2]</b>			
$U_n \leq 300\text{ V}$	 Four-pole, 2 x 2P in parallel, connected in series	 Four-pole, 2 x 2P in parallel	 Four-pole, 2 x 2P in parallel
$300\text{ V} < U_n \leq 600\text{ V}$	 Four-pole, 2 x 2P in parallel, connected in series	 Four-pole, 2 x 2P in parallel	 Four-pole, 2 x 2P in parallel

[1] ComPacT NSX DC circuit breakers (and switch disconnectors) are designed to break the rated current or fault current at the rated operational voltage ( $U_e$ ) with all poles. To break the current at voltage  $> 250\text{ V}$ , two poles in series are required. In double earth fault situations (A + D or C + E), the circuit breaker (and switch disconnectors) must break the current at full voltage with only half of the poles. ComPacT NSX DC circuit breakers (and switch disconnectors) are not designed for this purpose and could sustain irremediable damage if used to break the current in a double earth fault situation for voltage  $> 250\text{ V}$ .

[2] Do not remove parallel connectors.

[3] ComPacT NSX DC circuit breakers (and switch disconnectors) are designed to break the rated current or fault current at the rated operational voltage ( $U_e$ ) with all poles. To break the current at voltage  $> 300\text{ V}$ , two poles in series are required. In double earth fault situations (A + D or C + E), the circuit breaker (and switch disconnectors) must break the current at full voltage with only half of the poles. ComPacT NSX DC circuit breakers (and switch disconnectors) are not designed for this purpose and could sustain irremediable damage if used to break the current in a double earth fault situation for voltage  $> 300\text{ V}$ .



# Selection Guide for DC Circuit Breakers

## Solutions Depending on the Distribution System and the Voltage

### Comparison of Series and Parallel Connection in Terms of Performance

#### Series connection of poles on a DC circuit breaker is the means to:

- Divide the system voltage by the number of poles
  - Use the rated current for each pole
  - Use the breaking capacity of the circuit breaker for all the poles.
- For example, a ComPacT NSX630, 3P DC type, with the three poles connected in series, provides:
- A maximum voltage of 750 V (250 V per pole)
  - A rated current of 630 A
  - A breaking capacity of 100 kA/750 V.
- Consequently, a 630 A/250 V device can be used in a 750 V system.

#### Parallel connection of poles, on the contrary, imposes the system voltage on each pole, but is the means to:

- Divide the current flowing through each pole by the number of poles
  - Increase the rated current.
- For example, the same ComPacT NSX630 DC 3P circuit breaker with three poles in parallel provides:
- A maximum voltage of 250 V (250 V per pole)
  - A rated current of 1500 A (see table page B-9).
- Consequently, a 630 A device used in a 250 V system can handle 1500 A.

Series connection of poles divides the voltage per pole and optimizes breaking capacity for high-voltage systems.

Parallel connection of poles divides the current per pole and optimizes the rated current for systems that do not exceed the withstand voltage of each pole.

The maximum useable rating and the value of the magnetic setting are indicated (see pages B-7, B-8 and B-9).

A

# Selection Guide for DC Circuit Breakers

## Examples of Circuit Breaker Selection

A

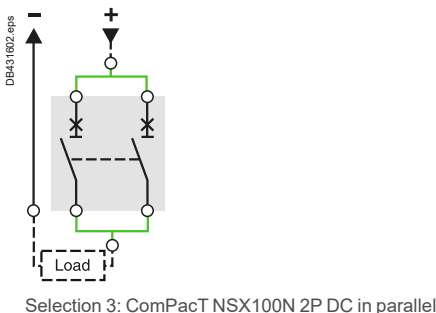
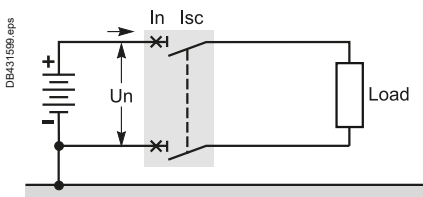
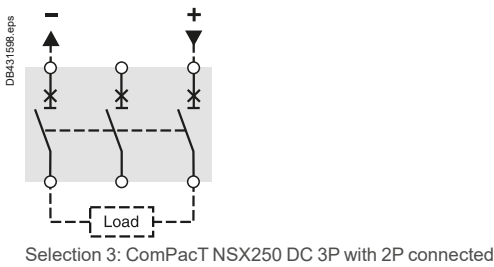
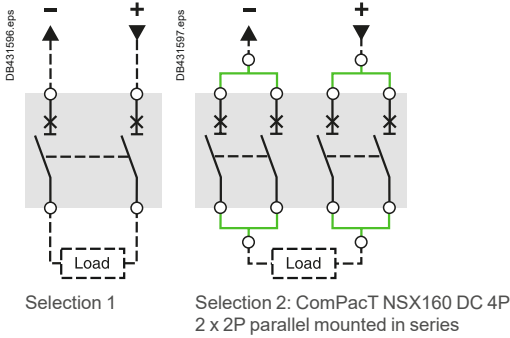
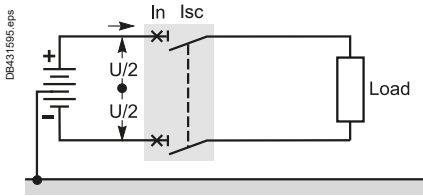

### Selection of a ComPacT NSX DC

#### Example 1

- Type of system - mid-point connected to earth
- System voltage -  $U_n = 500$  V DC with time constant  $L/R = 5$  ms
- Rated current required at point of installation  $I_n = 250$  A
- Short-circuit current at the point of installation  $I_{sc} = 20$  kA

#### Selection constraints - (see page A-4)

The system with the mid-point connected to earth requires (see conclusion page A-4):

- Identical protection-pole layout for each polarity.
- An equal number of poles for each polarity, i.e. a total of two or four.
- All poles of the two polarities must have breaking capacity  $\geq I_{sc}$  max. at  $U_n$ , i.e. 20 kA/500 V in this case.
- All poles of the each polarity must have breaking capacity  $\geq I_{sc}$  max. at  $U_n/2$ , i.e. 20 kA/250 V in this case.

#### Selection possibilities - (see pages A-5 and A-6)

The tables indicate for  $250$  V  $< U_n \leq 500$  V and for this system:

- Poles connected in series: two-pole 2P in series  $\rightarrow$  selection 1
- Poles connected in parallel: four-pole 2 x 2P parallel connected in series  $\rightarrow$  selection 2.

#### Circuit breaker selection - (see pages A-14 and B-8)

- **Selection 1:** The 250 A rated current does not exist in 2P. It is possible to use a 250 A 3P DC type circuit breaker with the central pole not connected  $\rightarrow$  selection 3
- **Selection 2:** The 160 A rated current (DC version) is suitable with a 2 x 2P assembly connected in parallel because (see table page B-8):
  - The rated current of the 2 x 2P assembly connected in parallel is  $I_n = 288$  A  $> 250$  A
  - And for  $L/R = 5$  ms:
    - Breaking capacity of all poles = 36 kA/500 V  $> 20$  kA/500 V
    - Breaking capacity of poles of each polarity = 36 kA/250 V  $> 20$  kA/250 V.

The options are:

- **Selection 1:** ComPacT NSX250S DC, 3P, 2 poles connected
  - **Selection 3:** ComPacT NSX160 DC, 4P, 2 x 2P parallel connected in series.
- Both solutions exist in fixed and withdrawable configurations.

#### Trip unit selection

- ComPacT NSX250 DC 3P: The selection table (see page A-18) indicates 3 TM250DC trip units, which are interchangeable
- ComPacT NSX160 DC, 4P (2 x 2P) 160 A: The selection table (see page B-8) indicates, for the 2 x 2P parallel configuration mounted in series and for 250 A, A TM125DC trip unit with the magnetic-protection threshold set to 2500 A.

#### Example 2

- Type of system - one polarity earthed
- System voltage -  $U_n = 250$  V DC with time constant  $L/R = 5$  ms
- Rated current required at point of installation  $I_n = 160$  A
- Short-circuit current at the point of installation  $I_{sc} = 20$  kA.

#### Selection constraints - (see page A-4)

The system with one polarity connected to earth requires (see conclusion page A-4):

- Protection poles on the protected polarity
- All poles contribute to breaking for the polarity:
  - 1, 2 or 3P without disconnection of the two polarities
  - 2, 3 or 4P with disconnection of the two polarities
- All poles of the protected polarity must have breaking capacity  $\geq I_{sc}$  max. at  $U_n$ , i.e. 20 kA/250 V in this case.

#### Selection possibilities - (see pages A-5 and A-6)

The tables indicate for  $U_n \leq 250$  V and for this system:

- Poles connected in series: single-pole  $\rightarrow$  selection 1 (or two-pole with disconnection  $\rightarrow$  selection 2)
- Poles connected in parallel: two-pole  $\rightarrow$  selection 3
- Other selections (parallel connection) are possible, but are of no particular interest.

#### Circuit breaker selection - (see pages A-14 and B-7)

- **Selection 1:** ComPacT NSX160F DC, 1P, 36 kA, available in fixed version (or selection 2: ComPacT NSX160F DC, 2P, 36 kA, if disconnection of the two polarities is desired)
- **Selection 3:** ComPacT NSX100N DC, 2P in parallel, 36 kA, providing a rated current of 200 A (see table page B-7), available in fixed version.

#### Trip unit selection

- ComPacT NSX160N DC, 1P: The selection table (see page A-18) indicates a built-in TM160DC trip unit with the magnetic-protection threshold set to 1250 A
- ComPacT NSX100N DC, 2P in parallel: The selection table (see page B-7) indicates, for the 2P parallel configuration and for 160 A, a TM80D trip unit with the magnetic-protection threshold set to 1600 A.

## Solutions Depending on the Distribution System and the Voltage

Type of distribution system			
Type	Earthed		Isolated
Source	One polarity (negative here) connected to earth (or exposed conductive parts)		Mid-point connected to earth Isolated polarities
Protected polarities	1 (disconnection of 1P)	2 (disconnection of 2P)	2
Diagrams, connection method			



## Series Connection of Poles

Selection of switch-disconnectors and pole connection				
ComPacT INS/INV				
24 V ≤ Un ≤ 125 V				
125 V < Un ≤ 250 V				Not applicable

[1] A 3P switch-disconnectors can be used if a 2P version does not exist. In this case, the central pole is not connected.

## Parallel Connection of Poles

Selection of switch-disconnectors and pole connection				
ComPacT INS/INV				
Un ≤ 63 V				
63 V < Un ≤ 125 V		Not applicable		Not applicable

# Selection Guide for DC Circuit Breakers

## Examples of Circuit Breaker Selection

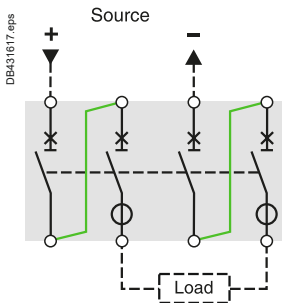
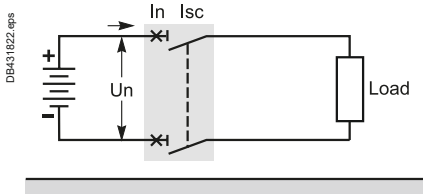

MasterPact NW20H DC version E

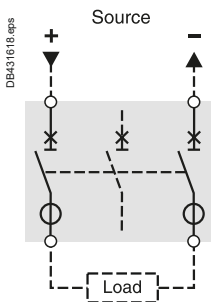
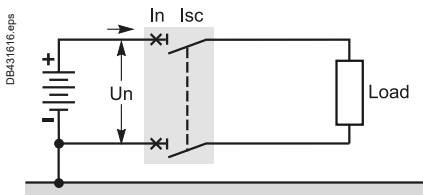

MasterPact NW10N DC version C

### Selection of a MasterPact NW DC

#### Example 1

- Type of system - isolated polarities
- System voltage -  $U_n = 750 \text{ V DC}$  with time constant  $L/R = 30 \text{ ms}$
- Rated current required at point of installation  $I_n = 2000 \text{ A}$
- Short-circuit current at the point of installation  $I_{sc} = 40 \text{ kA}$

#### Selection constraints - (see page A-4)

The system with isolated polarities requires (see conclusion page A-4):

- Identical protection for each polarity
- An equal number of poles for each polarity, i.e. a total of two or four
- All poles of each polarity must have breaking capacity  $\geq I_{sc \text{ max. at } U_n}$ , i.e.  $40 \text{ kA}/750 \text{ V}$  in this case.

#### Selection possibilities - (see page A-5)

The table for series poles indicates for a voltage  $24 \text{ V} < U_n \leq 750 \text{ V}$  and the type of system, use of a four-pole, version E circuit breaker.

#### Circuit breaker selection - (see page A-102)

The MasterPact NW DC characteristics table indicates more specifically with a  $2000 \text{ A}$  a NW20 DC type H circuit breaker with a breaking capacity of  $50 \text{ kA}/750 \text{ V}$  ( $L/R = 30 \text{ ms}$ ).

The correct selection is a MasterPact NW20 DC type H version E,  $2000 \text{ A}$ ,  $50 \text{ kA}$ , available in fixed and drawout versions.

#### Example 2

- Type of system - one polarity earthed
- System voltage -  $U_n = 500 \text{ V DC}$  with time constant  $L/R = 15 \text{ ms}$
- Rated current required at point of installation  $I_n = 1000 \text{ A}$
- Short-circuit current at the point of installation  $I_{sc} = 30 \text{ kA}$

#### Selection constraints - (see page A-4)

The system with one polarity connected to earth requires (see conclusion page A-4):

- Protection poles on the protected polarity
  - 1, 2 or 3P without disconnection of the two polarities
  - 2, 3 or 4P with disconnection of the two polarities
- All poles of the protected polarity must have breaking capacity  $\geq I_{sc \text{ max. at } U_n}$ , i.e.  $30 \text{ kA}/500 \text{ V}$  in this case.

#### Selection possibilities - (see page A-5)

The table for series poles indicates for a voltage  $24 \text{ V} < U_n \leq 500 \text{ V}$  and the type of system, use of a three-pole, version C circuit breaker.

#### Circuit breaker selection - (see page A-102)

The MasterPact NW DC characteristics table indicates more specifically with a  $1000 \text{ A}$  a NW10 DC type N circuit breaker with a breaking capacity of  $35 \text{ kA}/500 \text{ V}$  ( $L/R = 15 \text{ ms}$ ). The correct selection is a MasterPact NW10 DC type N version C,  $1000 \text{ A}$ ,  $35 \text{ kA}$ , available in fixed and drawout versions.



# Calculation of DC Distribution-System Characteristics

## Short-Circuit Currents L/R Time Constant

### Short-Circuit Currents

#### Calculation of the short-circuit current across the terminals of a battery

This calculation is key information to select a product. During a short-circuit, the battery discharges a current equal to:

$$I_{sc} = \frac{V_b}{R_i}$$

- $V_b$  = maximum discharge voltage (battery 100 % charged)
- $R_i$  = internal resistance equivalent to all cells (a function of the capacity in ampere-hours).

#### Example

- Consider a set of four 500 Ah batteries connected in parallel.
- Discharge voltage of one battery: 240 V (110 cells 2.2 V each).
- Discharge current of one battery: 300 A with a run-time of 30 minutes.
- Discharge current of all four batteries: 1200 A with a run-time of 30 minutes.
- Internal resistance 0.5 mΩ per cell, i.e. for one battery:  
 $R_i = 110 \times 0.5 \times 10^{-3} = 55 \times 10^{-3} \Omega$ .
- Short-circuit current of one battery:  $I_{sc} = 240 \text{ V} / 55 \times 10^{-3} \Omega = 4.37 \text{ kA}$ .
- Neglecting the resistance of the connections, for all four batteries discharging the short-circuit current in parallel, the total short-circuit current is four times that of one battery, i.e.  $I_{sc} = 4 \times 4.37 \text{ kA} = 17.5 \text{ kA}$ .

**Note:** If the internal resistance is not known, it is possible to use the following rough approximation:  $I_{sc} = kc$  where  $c$  is the capacity of the battery in ampere-hours and  $k$  is a coefficient close to 10 and always less than 20.

#### Other typical example

PABXs:  $I_{sc}$  from 5 to 25 kA at 240 V DC with  $L/R = 5 \text{ ms}$ .

### L/R Time Constant

When a short-circuit occurs across the terminals of a DC circuit, the current rises from the load current ( $\leq I_n$ ) to the short-circuit current  $I_{sc}$  over a period of time that depends on the value of the resistance  $R$  and inductance  $L$  of the short-circuited loop.

The equation determining the current in the loop is:

$$U = Ri + L \Delta i / \Delta t$$

The curve of  $i$  versus time is defined (neglecting  $I_n$ ) by the equation:

$$i = I_{sc} (1 - \exp(-t/\tau))$$

where  $\tau = L/R$  is the time constant for the rise to  $I_{sc}$ .

Practically speaking, after a time  $t = 3\tau$ , the short-circuit is considered to be established, because the value of  $\exp(-3) = 0.05$  is negligible compared to 1 (see the curve opposite).

The lower the time constant (e.g. battery circuit), the shorter the time required for the current to rise to  $I_{sc}$ .

To express breaking capacity, the interrupted short-circuit current with the following time constants is used:

- $L/R = 5 \text{ ms}$ , fast short-circuit
- $L/R = 15 \text{ ms}$ , standardized value used in standard IEC 60947-2
- $L/R = 30 \text{ ms}$ , slow short-circuit.

In general, the value of the system time constant is calculated under worst-case conditions, across the terminals of the generator.

Breaking-capacity values for:

- ComPacT NSX DC (table page A-14) are the same for 5 ms and 15 ms
- MasterPact NW DC (table page A-102) are indicated for 3 values, 5 ms, 15 ms And 30 ms.

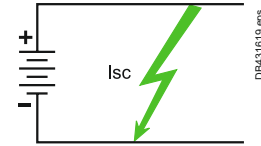

DB431619.eps

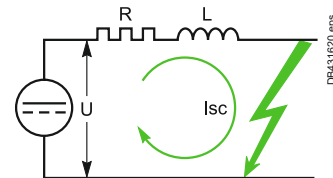

DB431620.eps

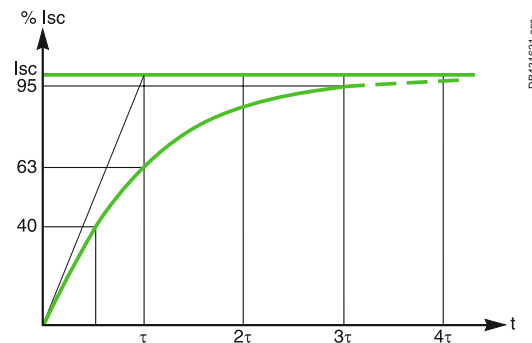

DB431621.eps

# General Characteristics of ComPacT NSX DC, DC PV and DC EP Operating Conditions

A

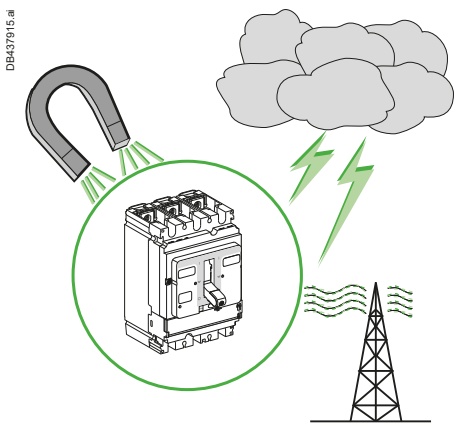
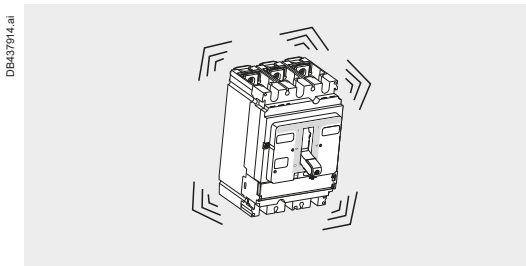
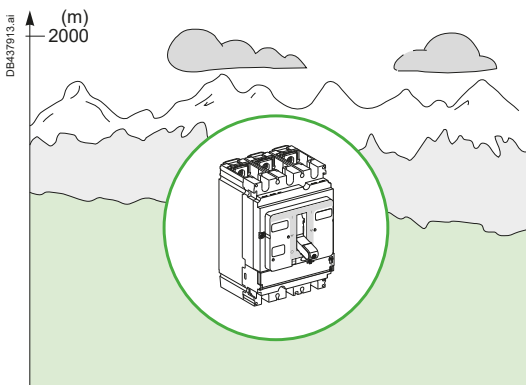

## Altitude

ComPacT NSX circuit breakers are designed to operate at their rated values at altitudes under 2000 metres.

Above 2000 metres, the changes in the characteristics of the ambient air (electrical resistance, cooling capacity) result in a reduction of the characteristics below.

Altitude (m)	2000	3000	4000	5000
<b>ComPacT NSX DC</b>				
Impulse withstand voltage $U_{imp}$ (kV)	8	7.1	6.4	5.6
Rated insulation voltage ( $U_i$ )	750	710	635	560
Maximum rated operational DC voltage	1 x $U_e$	0.88 x $U_e$	0.8 x $U_e$	0.7 x $U_e$
Rated current (A)	1 x $I_n$	0.96 x $I_n$	0.93 x $I_n$	0.9 x $I_n$
<b>ComPacT NSX DC PV</b>				
Impulse withstand voltage $U_{imp}$ (kV)	8	7.1	6.4	5.6
Rated insulation voltage ( $U_i$ )	1000	900	800	700
Maximum rated operational DC voltage	1000	900	800	700
Rated current (A)	1 x $I_n$	0.96 x $I_n$	0.93 x $I_n$	0.9 x $I_n$
<b>ComPacT NSX DC EP</b>				
Impulse withstand voltage $U_{imp}$ (kV)	8	7.1	6.4	5.6
Rated insulation voltage ( $U_i$ )	1600	1400	1250	1100
Maximum rated operational DC voltage	1500	1300	1150	1000
Rated current (A)	1 x $I_n$	0.96 x $I_n$	0.93 x $I_n$	0.9 x $I_n$

## Vibrations

ComPacT NSX circuit breakers are tested electromagnetic or mechanical vibration resistant.

Tests are carried out in compliance with standard IEC 60068-2-6 for the levels required by merchant-marine inspection organizations (Veritas, Lloyd's, etc.):

- 2 to 13.2 Hz: amplitude  $\pm 1$  mm
- 13.2 to 100 Hz: constant acceleration 0.7 g.

Excessive vibration may cause tripping, breaks in connections or damage to mechanical parts.

## Electromagnetic Compatibility

ComPacT NSX circuit breakers are tested against:

- Overvoltages caused by devices that generate electromagnetic disturbances
- Overvoltages caused by atmospheric disturbances or by a distribution-system outage (e.g. failure of a lighting system) and devices emitting radio waves (radios, walkie-talkies, radar, etc.)
- Electrostatic discharges produced by users. The circuit breakers have successfully passed the electromagnetic-compatibility tests (EMC) defined by international standard IEC 60947-2, appendix F.

The above tests show that:

- No nuisance tripping occurs
- Tripping times are respected.

ComPacT NSX circuit breakers comply with the following electromagnetic-compatibility standards:

- IEC/EN 61000-4-2 - electrostatic immunity discharge test, part 2 (circuit breakers)
- IEC/EN 61000-4-3 - electromagnetic-field immunity test
- IEC/EN 61000-4-4 - electrical fast transient/burst immunity test
- IEC/EN 61000-4-5 - surge immunity test
- IEC/EN 61000-4-6 - immunity to conducted disturbances, induced by radiofrequency fields
- CISPR 11 - radio-frequency conducted and radiated emission tests required for CE marking:
  - EN 61000-6-2 - immunity standard for industrial environments
  - EN 50081-1-2 - emissions in commercial and industrial environments.

## Ambient Temperature

### Operating-Temperature Range

- ComPacT NSX circuit breakers and switches may be used between  $-25^\circ\text{C}$  and  $+70^\circ\text{C}$ .
- For temperatures higher than  $40^\circ\text{C}$  ( $65^\circ\text{C}$  for circuit breakers used to protect motor feeders), devices must be derated as indicated in the documentation.
- Circuit breakers and switches should be put into service under the normal, ambient operating temperatures indicated above. Exceptionally, they may be put into service when the ambient temperature is between  $-35^\circ\text{C}$  and  $-25^\circ\text{C}$ .

### Derating

Above  $40^\circ\text{C}$ , it is necessary to take into account the derating values.

### Storage-Temperature Range

ComPacT NSX circuit breakers and switches may be stored in their original packing between  $-50^\circ\text{C}$  and  $+85^\circ\text{C}$ .

# General Characteristics of ComPacT NSX DC, DC PV and DC EP

## ComPacT NSX DC and DC PV



### Installation in Class II Switchboards

All ComPacT NSX DC circuit breakers are class II front-face devices. They may be installed through the door of class II switchboards (as per standard IEC 60664) without downgrading switchboard insulation. ComPacT NSX DC EP should be either installed in IP5x enclosure or with rotary handles or IP43 rubber toggle covers. Installation requires no special operations even when the circuit breaker is equipped with a rotary handle or a motor mechanism.

### Degree of Protection

ComPacT NSX DC circuit breakers offer the following protection characteristics depending on the installation conditions:

- IP: Degree of protection (standard IEC 60529)
- IK: Protection against external mechanical imPacTs (standard EN 50102).

### ComPacT NSX DC

#### Bare circuit breaker with terminal shields

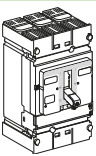
		With toggle	IP3X	IK07
---	---	-------------	------	------

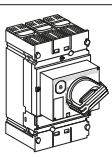
		With direct rotary handle, standard or VDE	IP3X	IK07
---	--	--	------	------

#### Circuit breaker installed in a switchboard

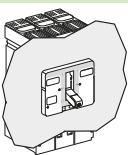
		With toggle	IP40	IK07
---	---	-------------	------	------

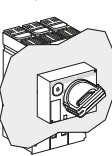
		With direct rotary handle, standard or VDE	IP40	IK07
		CCM	IP43	IK07
		CNOMO	IP54	IK07

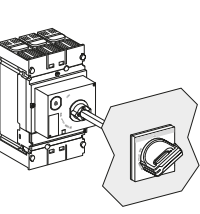
		With extended rotary handle	IP55	IK08
---	---	-----------------------------	------	------

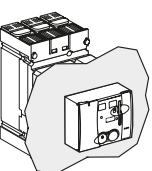
		With motor mechanism	IP40	IK07
---	---	----------------------	------	------

### Positive Contact Indication

ComPacT NSX DC circuit breakers are suitable for isolation as defined by IEC 60947-1 and 60947-2:

- The isolation position corresponds to the O (OFF) position
- The operating handle and the indicators cannot indicate the OFF position unless the contacts are effectively open
- Padlocks may not be installed unless the contacts are open.

The isolation function is certified by tests to achieve:

- The mechanical reliability of the position-indication system
- The absence of leakage currents
- Overvoltage withstand capacity between upstream and downstream connections.

For ComPacT NSX DC, installation of a rotary handle or a motor mechanism does not alter the reliability of the position-indication system.



# Circuit Breaker Characteristics

## ComPacT NSX100 DC to NSX250 DC

A



### ComPacT NSX DC circuit breaker

Basic frame	Number of poles		
-------------	-----------------	--	--

#### Electrical Characteristics As Per IEC 60947-1/ 60947-2 and EN 60947-1/60947-2

Rated current at 40 °C	<b>In</b>	(A)	
Rated insulation voltage	<b>Ui</b>	(V)	
Rated impulse withstand voltage	<b>Uimp</b>	(kV peak)	
Rated operational voltage	<b>Ue</b>	(V DC)	

#### Type of circuit breaker

Ultimate breaking capacity (L/R = 5 ms and L/R = 15 ms)	<b>Icu</b>	(kA rms)	V DC	24-125 V (1P) <sup>[1]</sup>
				250 V (1P) <sup>[1]</sup>
				500 V (2P) <sup>[1]</sup>
				750 V (3P) <sup>[1]</sup>

Service breaking capacity	<b>Ics</b>	% Icu
Rated making capacity	<b>Icm</b>	% Icu
Utilization category		
Breaking time		(ms)
Suitability for isolation		

Pollution degree (as per IEC 60664-1)

#### Protection against overcurrents (see trip unit table page A-19)

Trip units	Built-in
	Interchangeable
Protection	Overloads
	Short-circuits

#### Durability

(O/C cycles)	Mechanical	
	Electrical	250 V In
		250 V In/2
		500 V In
		500 V In/2
		750 V In
750 V In/2		

#### Indication and Control Auxiliaries

Auxiliary contacts	
Voltage release	MX shunt release MN undervoltage release

#### Installation and Connections

Fixed	Front connection	
	Rear connection	
Plug-in (base)	Front connection	
	Rear connection	
Withdrawable (chassis)	Front connection	
	Rear connection	
Control	Manual	with toggle
		with direct or extended rotary handle
	Electrical	with remote control

#### Dimensions and Weight

Dimensions H x W x D (mm) connected in series	Fixed	(mm)	1P
			2P
			3P
			4P
Weight (kg) connected in series	Fixed	(kg)	1P
			2P
			3P
			4P

<sup>[1]</sup> Number of poles in series taking part in current interruption.

Example. The NSX100N DC circuit breaker exists in the following versions:

- 1 pole with an Icu of 50 kA, for systems ≤ 250 V
- 2 poles with an Icu of 85 kA, for systems ≤ 500 V; 1 pole can be used in a 250 V system.



# Circuit Breaker Characteristics

## ComPacT NSX100 DC to NSX250 DC



NSX100 DC									NSX160 DC						NSX250 DC				
1			2			3/4			1		2		3/4		3/4				
100									160						250				
750									750						750				
8									8						8				
250			500			750			250		500		750		750				
F	N	M	F	M	S	F	S	F	N	M	F	M	S	F	S	F	S		
36	50	85	36	85	100	36	100	36	50	85	36	85	100	36	100	36	100		
36	50	85	36	85	100	36	100	36	50	85	36	85	100	36	100	36	100		
-	-	-	36	85	100	36	100	-	-	-	36	85	100	36	100	36	100		
-	-	-	-	-	-	36	100	-	-	-	-	-	-	36	100	36	100		
100 %									100 %						100 %				
100 %									100 %						100 %				
A									A						A				
< 10 ms									< 10 ms						< 10 ms				
3									3						3				
							-								-	-	-		
-	-	-	-	-	-			-	-	-	-	-	-						
10000									10000						10000				
5000									5000						5000				
10000									10000						10000				
5000									5000						5000				
10000									10000						10000				
5000									5000						5000				
10000									10000						10000				
-									-										
-									-										
-									-										
-	-	-	-	-	-			-	-	-	-	-	-						
-	-	-	-	-	-			-	-	-	-	-	-						
-	-	-	-	-	-			-	-	-	-	-	-						
-	-	-	-	-	-			-	-	-	-	-	-						
-								-											
-								-											
161 x 35 x 86			-			-			161 x 35 x 86		-		-		-		-		
-			161 x 70 x 86			-			-		161 x 70 x 86		-		-		-		
-			-			161 x 105 x 86			-		-		-		161 x 105 x 86		-		
-			-			161 x 140 x 86			-		-		-		161 x 140 x 86		-		
0.7			-			-			0.7		-		-		-		-		
-			1.2			-			-		1.2		-		-		-		
-			-			1.6 to 1.9			-		-		-		1.6 to 1.9		-		
-			-			2.1 to 2.3			-		-		-		2.1 to 2.3		-		

# Circuit Breaker Characteristics

## ComPacT NSX400 DC to NSX1200 DC

10\_C0857M000 eps



A

### ComPacT NSX DC circuit breaker

Basic frame		Number of poles	
<b>Electrical Characteristics As Per IEC 60947-1/ 60947-2 and EN 60947-1/60947-2</b>			
Rated current at 40 °C	<b>In</b>	(A)	
Rated insulation voltage	<b>Ui</b>	(V)	
Rated impulse withstand voltage	<b>Uimp</b>	(kV peak)	
Rated operational voltage	<b>Ue</b>	(V DC)	
<b>Type of circuit breaker</b>			
Ultimate breaking capacity (L/R = 5 ms and L/R = 15 ms)	<b>Icu</b>	(kA rms)	V DC 24-125 V (1P) <sup>[1]</sup>
			250 V (1P) <sup>[1]</sup>
	<b>Icu</b>	(kA rms)	V DC 500 V (2P) <sup>[1]</sup>
			750 V (3P) <sup>[1]</sup>
Service breaking capacity	<b>Ics</b>	% Icu	V DC 24-300 V (1P) <sup>[1]</sup>
			300-600 V (2P) <sup>[1]</sup>
Rated making capacity	<b>Icm</b>	% Icu	
Utilization category			
Breaking time		(ms)	
Suitability for isolation			
Pollution degree (as per IEC 60664-1)			
<b>Protection against overcurrents (see trip unit table page A-19)</b>			
Trip units		Interchangeable	
Protection		Overloads	
		Short-circuits	
<b>Durability</b>			
(O/C cycles)		Mechanical	
		Electrical	250 V In
			250 V In/2
			500 V In
			500 V In/2
			750 V In
			750 V In/2
			600 V In
			600 V In/2
<b>Indication and Control Auxiliaries</b>			
Auxiliary contacts			
Voltage release		MX shunt release	
		MN undervoltage release	
<b>Installation and Connections</b>			
Fixed		Front connection	
		Rear connection	
Plug-in (base)		Front connection	
		Rear connection	
Withdrawable (chassis)		Front connection	
		Rear connection	
Control	Manual	with toggle	
		with direct or extended rotary handle	
	Electrical	with remote control	
<b>Dimensions and Weight</b>			
Dimensions H x W x D (mm) connected in series	Fixed	(mm)	1P
			2P
			3P
			4P
Weight (kg) connected in series	Fixed	(kg)	1P
			2P
			3P
			4P

[1] Number of poles in series taking part in current interruption.  
 Example. The NSX100N DC circuit breaker exists in the following versions:  
 - 1 pole with an Icu of 50 kA, for systems ≤ 250 V  
 - 2 poles with an Icu of 85 kA, for systems ≤ 500 V; 1 pole can be used in a 250 V system.

# Circuit Breaker Characteristics

## ComPacT NSX400 DC to NSX1200 DC

NSX400 DC						NSX630 DC				NSX1200 DC					
3/4						3/4				2					
250	320	400	500	600		630	800	1000	1200			630	800	1000	1200
750	750	750	750	750		750	750	750	750			750	750	750	750
8	8	8	8	8		8	8	8	8			8	8	8	8
750	750	750	750	500		600	600	600	600			600	600	600	600
<b>F</b>	<b>S</b>	<b>F</b>	<b>S</b>	<b>F</b>	<b>S</b>	<b>F</b>	<b>S</b>	<b>F</b>	<b>S</b>	<b>N</b>					
36	100	36	100	36	100	36	100	36	100	-	-	-	-	-	
36	100	36	100	36	100	36	100	36	100	-	-	-	-	-	
36	100	36	100	36	100	36	100	36	100	-	-	-	-	-	
36	100	36	100	36	100	36	100	-	-	-	-	-	-	-	
-	-	-	-	-	-	-	-	-	-	50	50	50	50	50	
-	-	-	-	-	-	-	-	-	-	50	50	50	50	50	
100 %				100 %		100 %				25 %					
100 %				100 %		100 %				100 %					
A															
10ms															
3															
-															
5000			5000	5000		5000	5000			-					
1000			1000	1000		1000	1000			-					
2000			2000	2000		2000	2000			-					
1000			1000	1000		1000	1000			-					
2000			2000	2000		2000	2000			-					
1000			1000	1000		1000	1000			-					
2000			2000	2000		2000	2000			-					
-			-	-		-	-			1000					
-			-	-		-	-			2000					
										-	-	-	-	-	
										-	-	-	-	-	
										-	-	-	-	-	
										-	-	-	-	-	
-															
-															
255 x 140 x 110										350 x 185 x 110					
255 x 185 x 110										-					
-															
-										9.4					
8										-					
8.4										-					



# Trip Unit Characteristics

## Types of Trip Units - Trip Units for ComPacT NSX DC

C25NT1M250.eps



A

### Trip units for ComPacT NSX100 DC - NSX160 DC

#### Single-pole and two-pole (not interchangeable)

Type of trip unit		TM-D										
Rating	In (A) at 40 °C	16	20	25	30	40	50	63	80	100	125	160
ComPacT circuit breaker	NSX100 AC/DC	●	●	●	●	●	●	●	●	●	-	-
	NSX160 AC/DC	-	-	-	-	-	-	-	-	-	●	●

#### Overload protection (thermal)

Tripping threshold	Ir (A) at 40 °C	Fixed										
		16	20	25	30	40	50	63	80	100	125	160

#### Protection against short-circuits (magnetic)

Pick-up	li (A)	Fixed										
ComPacT circuit breaker	NSX100/160 AC/DC True DC value	260	260	400	400	700	700	700	800	1000	1200	1250

C16S2TM160.eps



### Trip units for ComPacT NSX100 DC - NSX160 DC - NSX250 DC

#### Three-pole 3P-3d and four-pole 4P-4d (interchangeable trip units)

Type of trip unit		TM-D						TM-DC					
Rating (A)	In (A) at 40 °C	16	25	32	40	50	63	80	100	125	160	200	250
ComPacT circuit breaker	NSX100 DC	●	●	●	●	●	●	●	●	-	-	-	-
	NSX160 DC	-	-	-	-	-	-	-	-	●	●	-	-
	NSX250 DC	-	-	-	-	-	-	-	-	-	-	●	●

#### Overload protection (thermal)

Tripping threshold (A)	Ir (at 40 °C)	Adjustable																		
		0.7 to 1 x In																		

#### Protection against short-circuits (magnetic)

Pick-up (A)	li	Fixed											Adjustable
ComPacT circuit breaker	NSX100/160/NSX250 DC True DC value	260	400	550	700	700	700	800	800	1250	1250	5 to 10 x In	

C25F4TM250D1.eps



### Trip units for ComPacT NSX100 DC - NSX160 DC - NSX250 DC

#### Three-pole 3P-3d and four-pole 4P-4d (interchangeable trip units)

Type of trip unit		TM-G										
Rating (A)	In (A) at 40 °C	16	25	40	63	80	100	125	160	200	250	
ComPacT circuit breaker	NSX100 DC	●	●	●	●	●	●	●	●	-	-	
	NSX160 DC	-	-	-	-	-	-	●	●	-	-	
	NSX250 DC	-	-	-	-	-	-	-	-	●	●	

#### Overload protection (thermal)

Tripping threshold (A)	Ir (at 40 °C)	Adjustable																		
		0.7 to 1 x In																		

#### Protection against short-circuits (magnetic)

Pick-up (A)	li	Fixed										
ComPacT circuit breaker	True DC value	80	100	100	150	250	400	530	530	530	625	
	NSX100 DC											
	NSX160 DC	-	100	100	150	250	400	530	530	-	-	
	NSX250 DC	-	-	-	-	-	-	-	-	530	625	

10\_C06S3TM160D.eps



### Trip units for ComPacT NSX400DC - NSX1200DC

#### Three-pole, four-pole (not interchangeable)/Two-pole (not interchangeable)

Type of trip unit		TM-DC									
Rating (A)	In(A) at 40 °C	250 <sup>[1]</sup>	320	400	500	600	630	800	1000	1200	
ComPacT circuit breaker	NSX400DC	●	●	●	-	-	-	-	-	-	
	NSX630DC	-	-	-	●	●	-	-	-	-	
	NSX1200DC	-	-	-	-	-	●	●	●	●	

#### Overload protection (thermal)

Tripping threshold (A)	Ir (at 40 °C)	Adjustable 0.7 to 1 x in																		

#### Protection against short-circuits (magnetic)

Pick-up (A)	li	Adjustable 2.5 to 5 x in																		

[1] TM-DC 250 Adjustable range is 2.5 to 4 x In.

C1B2TM12HD.eps



Types of Trip Units - Trip Units for ComPacT NSX DC

**Types of Trip Units**

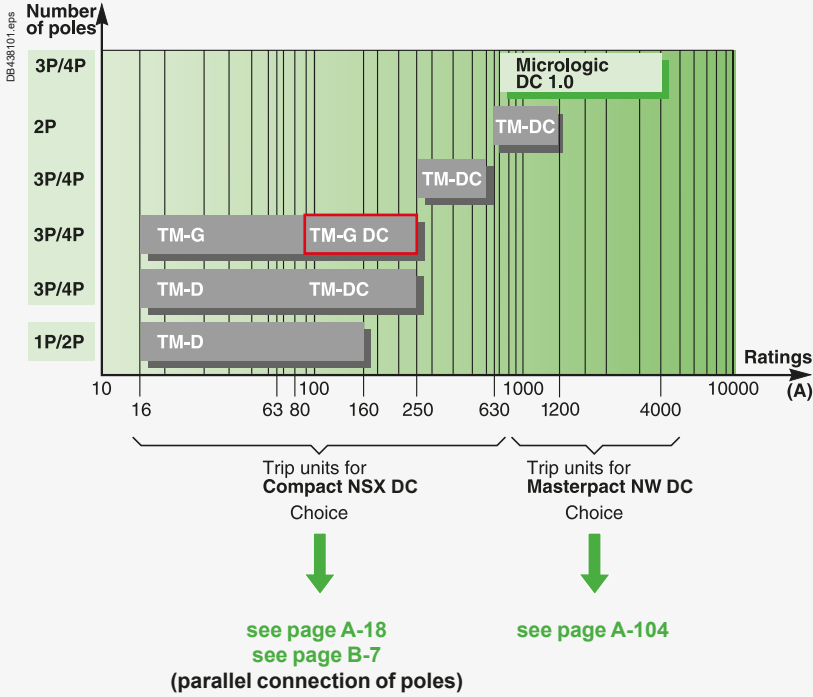

**Trip Units for ComPacT NSX DC**  
 TM Thermal-Magnetic Trip Unit up to 1200 A

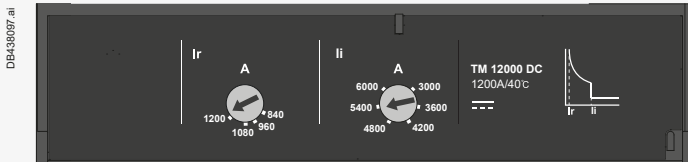

Up to 1200 A for ComPacT NSX DC, protection is provided by thermal-magnetic trip units.

- TM-D up to 160 A: Fixed thermal threshold and magnetic pick-up.
- TM-D up to 63 A: Adjustable thermal threshold and fixed magnetic pick-up.
- TM-DC from 80 to 250 A: Fixed or adjustable (for 200 and 250 A) magnetic pick-up and adjustable thermal threshold.
- TM-DC from 250 A to 1200 A adjustable magnetic pick-up and adjustable thermal threshold.
- TM-G, up to 250 A: Adjustable thermal threshold and fixed low magnetic pick-up to protect long cables.
- TM-G DC, up to 250A: Adjustable thermal threshold and fixed low magnetic pick-up to protect long cables.

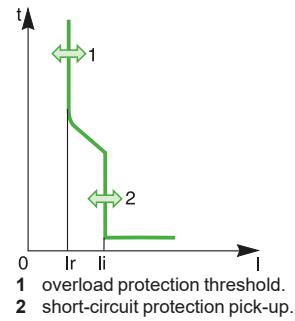



# Switch-Disconnectors

## Characteristics and Performance of ComPacT NSX Switch-Disconnectors from 100 to 250 NA

Installation standards require upstream protection. However ComPacT NSX100 to 630 NA switch-disconnectors are self-protected by their high-set magnetic release.

C2542001S.epa

A



ComPacT NSX100 to 250 NA

### Common characteristics

Rated voltages			
Insulation voltage (V)	<b>Ui</b>		750
Impulse withstand voltage (kV)	<b>Uimp</b>		8
Operational voltage (V)	<b>Ue</b>		750
Suitability for isolation		IEC/EN 60947-3	yes
Utilization category		DC 22 A/DC 23 A	
Pollution degree		IEC 60664-1	3

### Switch-disconnectors

#### Electrical Characteristics As Per IEC 60947-3 and EN 60947-3

Conventional thermal current (A) <b>I<sub>th</sub> 60 °C</b>			
Number of poles			
Operational current (A) depending on the utilization category	<b>Ie</b>	DC	250 V (1 pole) 500 V (2 poles in series) 750 V (3 poles in series)
Short-circuit making capacity (kA peak)	<b>I<sub>cm</sub></b>		Min. (switch-disconnector alone) Max. (protection by upstream NSX DC circuit breaker)
Rated short-time withstand current (A rms)	<b>I<sub>cw</sub></b>	for	1 s 3 s 20 s
Durability (C-O cycles)			
	Mechanical		
	Electrical	DC	250 V (1 pole) and In/2 500 V (2 poles in series)In

Positive contact indication

Pollution degree

#### Protection

Add-on earth-leakage protection By VigiPacT relay

#### Additional Indication and Control Auxiliaries

Indication contacts

Voltages releases MX shunt release  
MN undervoltage release

Current-transformer module

Insulation monitoring module

#### Remote Communication by Bus

Device-status indication

Device remote operation

Operation counter

#### Installation/Connections

Dimensions (mm)	Fixed, front connections	2/3P
W x H x D		4P
Weight (kg)	Fixed, front connections	3P 4P

#### TransferPacT Source-Changeover Systems

(See Chapter on TransferPacT Source-Changeover Systems)

Manual source-changeover systems

Remote-operated or automatic source-changeover systems

[1] 2P in 3P case.

Note: For more information, please see catalog ComPacT NSX LVPED221001EN.

# Switch-Disconnectors

## Characteristics and Performance of ComPacT NSX Switch-Disconnectors from 100 to 250 NA



Common characteristics			
<b>Control</b>			
Manual	With toggle		<input type="radio"/>
		With direct or extended rotary handle	<input type="radio"/>
	Electrical	With remote control	<input type="radio"/>
<b>Versions</b>			
Withdrawable	Fixed		<input type="radio"/>
	Plug-in base		<input type="radio"/>
		Chassis	<input type="radio"/>

NSX100NA	NSX160NA	NSX250NA
<b>100</b>	<b>160</b>	<b>250</b>
2 <sup>[1]</sup> , 3, 4	2 <sup>[1]</sup> , 3, 4	2 <sup>[1]</sup> , 3, 4
<b>DC22A/DC23A</b>	<b>DC22A/DC23A</b>	<b>DC22A/DC23A</b>
100	160	250
100	160	250
100	160	250
2.6	3.6	4.9
100	100	100
1800	2500	3500
1800	2500	3500
690	960	1350
50000	40000	20000
10000	10000	10000
5000	5000	5000
<input type="radio"/>	<input type="radio"/>	<input type="radio"/>
3	3	3
<input type="radio"/>		
<input type="radio"/>		
<input type="radio"/>		
<input type="radio"/>		
<input type="radio"/>		
<input type="radio"/>		
<input type="radio"/>		
<input type="radio"/>		
<input type="radio"/>		
<input type="radio"/>		
105 x 161 x 86		
140 x 161 x 86		
1.5 to 1.8		
2.0 to 2.2		
<input type="radio"/>		
<input type="radio"/>		

# Switch-Disconnectors Characteristics

## ComPacT NSX400/630 NA DC

CS3630DS eps



ComPacT NSX630 NA DC

CS4630DS eps



ComPacT NSX630 NA DC

A

### ComPacT NSX DC switch-disconnector

Number of poles

#### Electrical Characteristics As Per IEC 60947-3

Rated current (A) (free air + no venting)	$I_n$	40 °C
Altitude	m	2000
Rated insulation voltage (V)	$U_i$	
Rated impulse withstand voltage (kV)	$U_{imp}$	
Rated operational voltage (V)	$U_e$	DC

#### Type of circuit breaker

Rated short circuit withstand current (kA rms)	$I_{cw}/I_{cm}$	$t = 1\text{ s}$
Rated conditionnal short-circuit current	$I_q$	kA
	With back-up fuse	A gG
Rated conditionnal short-circuit current	$I_q$ with NSX DC circuit breaker	kA with MCCB

Utilization category  
Suitability for isolation

#### Durability

Endurance (C-O cycles)	Mechanical	
	Electrical ( $I_n$ )	750 V

#### Installation and connections

Control	Manual	Toggle
		Direct or extended rotary handle
	Motor mechanism	
Connections	Fixed	Front connection
		Long rear connection
	Plug-in (on base)	Front connection
		Rear connection
Withdrawable (on chassis)	Front connection	
	Rear connection	

#### Additional measurement, indication and control auxiliaries

Indication contacts	OF	Auxiliary contact
	SD, SDE	Trip, fault-trip
Voltage releases	MX, MN	Shunt trip/undervoltage release

#### Installation

Accessories	Crimp lugs/bare cable connector
	Terminal extensions and spreaders
	Escutcheons
	Terminal shields and interphase barriers
	Din rail adapter

#### Dimensions and weight

Dimensions (mm) H x W x D (w/o series connection)	3P
	4P
Weight (kg) (w/o series connection)	3P
	4P

# Switch-Disconnectors Characteristics

## ComPacT NSX400/630 NA DC

NSX400 NA DC		NSX630 NA DC	
3/4		3/4	
400		630	
<input checked="" type="checkbox"/>		<input checked="" type="checkbox"/>	
<b>750</b>		750	
8		8	
750		750	
7.5		7.5	
10		10	
400		630	
100		100	
DC22-A		DC22-A	
<input checked="" type="checkbox"/>		<input checked="" type="checkbox"/>	
3		3	
5000		5000	
1000		1000	
<input checked="" type="checkbox"/>		<input checked="" type="checkbox"/>	
<input checked="" type="checkbox"/>		<input checked="" type="checkbox"/>	
<input checked="" type="checkbox"/>		<input checked="" type="checkbox"/>	
<input checked="" type="checkbox"/>		<input checked="" type="checkbox"/>	
<input checked="" type="checkbox"/>		<input checked="" type="checkbox"/>	
<input checked="" type="checkbox"/>		<input checked="" type="checkbox"/>	
<input checked="" type="checkbox"/>		<input checked="" type="checkbox"/>	
<input checked="" type="checkbox"/>		<input checked="" type="checkbox"/>	
<input checked="" type="checkbox"/>		<input checked="" type="checkbox"/>	
<input checked="" type="checkbox"/>		<input checked="" type="checkbox"/>	
<input checked="" type="checkbox"/>		<input checked="" type="checkbox"/>	
<input checked="" type="checkbox"/>		<input checked="" type="checkbox"/>	
<input checked="" type="checkbox"/>		<input checked="" type="checkbox"/>	
<input checked="" type="checkbox"/>		<input checked="" type="checkbox"/>	
<input checked="" type="checkbox"/>		<input checked="" type="checkbox"/>	
<input checked="" type="checkbox"/>		<input checked="" type="checkbox"/>	
-		-	
255 x 140 x 110		255 x 140 x 110	
255 x 185 x 110		255 x 185 x 110	
6		6	
7.8		7.8	



# Accessories and Auxiliaries

## Overview of ComPacT NSX100 to 630 DC [\*] Fixed Version

A

### Insulation accessories

DE439586.ai

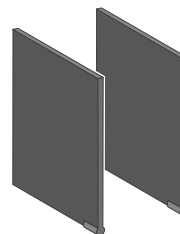
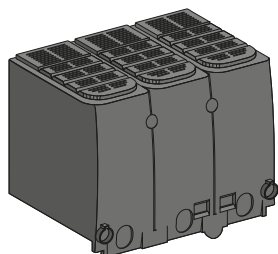

Interphase barriers

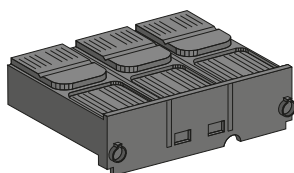

Sealable terminal shields

### Electrical auxiliaries ► A-39

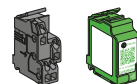

Indication contact

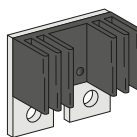

Heat sink

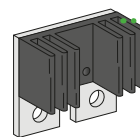

Voltage release

### Protection and measurements

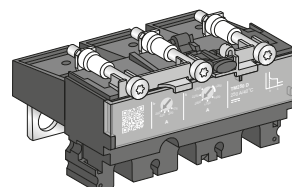

TM-D, TM-G trip unit

[\*] Applicable for circuit breaker up to 600 A see page A-16.



# Accessories and Auxiliaries

## Overview of ComPacT NSX100 to 630 DC [\*] Fixed Version

### Connection ► A-32

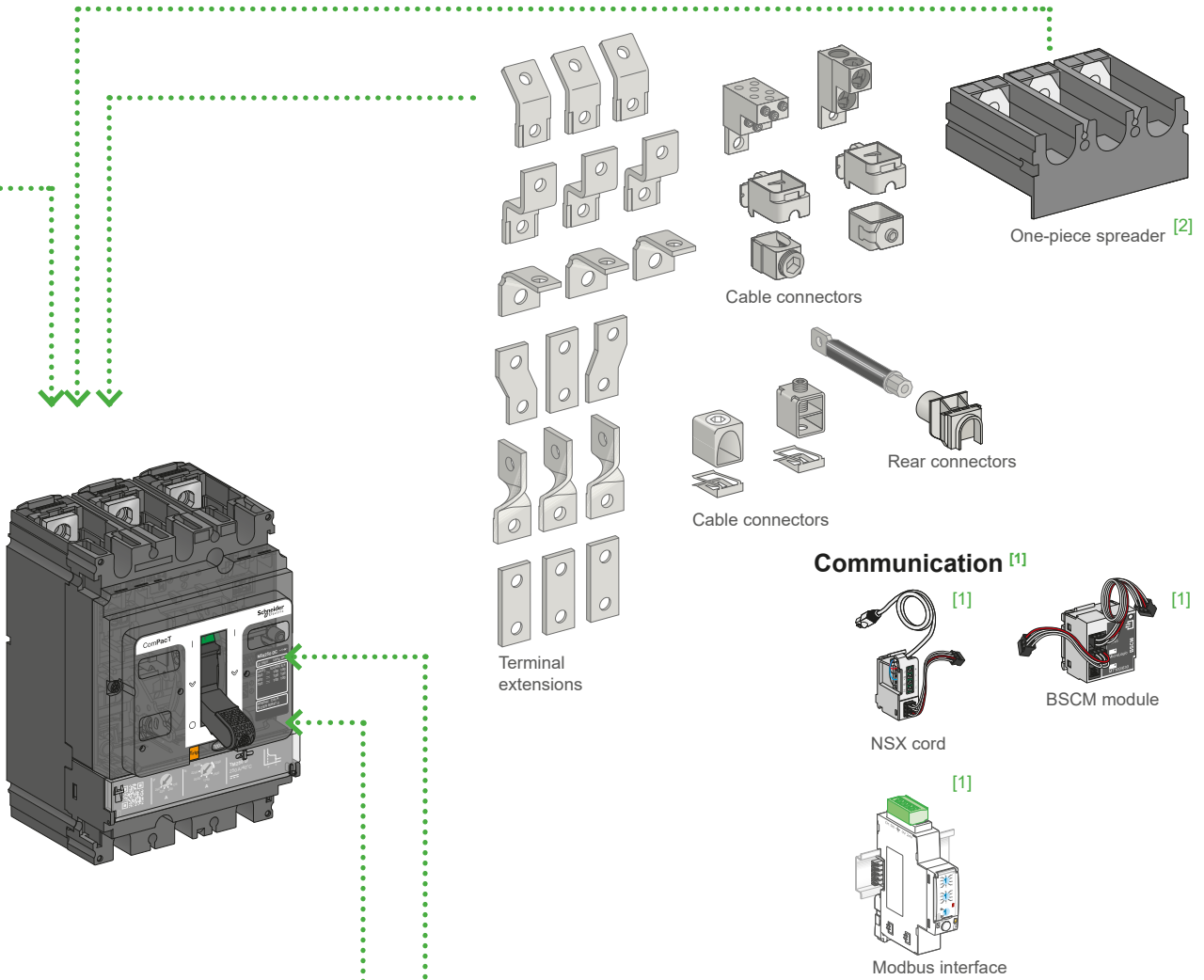

### Control accessories ► A-40

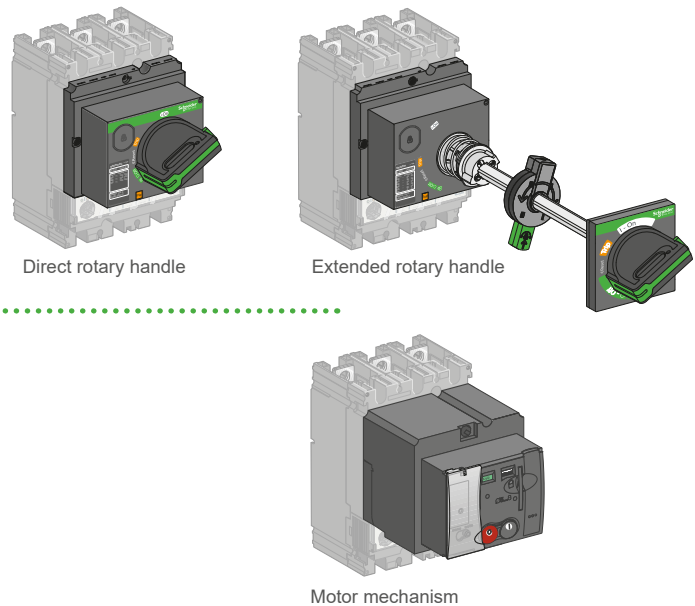

[1] See communication chapter.  
 [2] Only for ComPacT NSX100-250.

# Accessories and Auxiliaries

## Overview of ComPacT NSX1200 DC Fixed Version

### Insulation accessories

DB4C9587.rqs

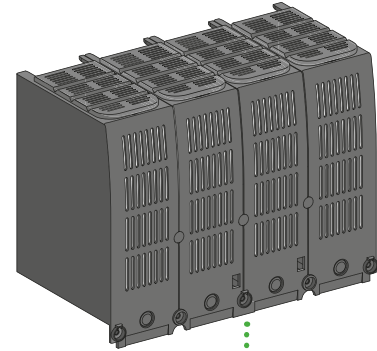

Sealable terminal shields

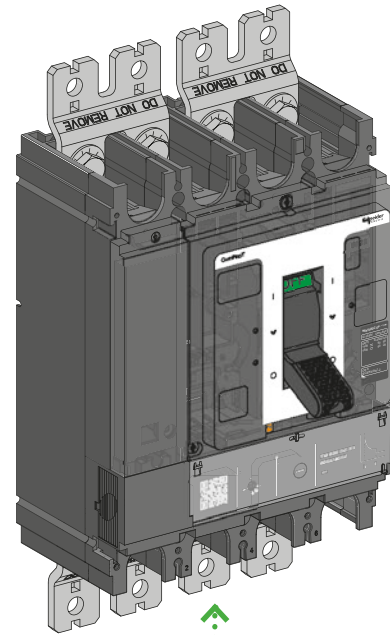

### Electrical auxiliaries ► A-39

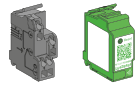

Indication contact



Voltage release

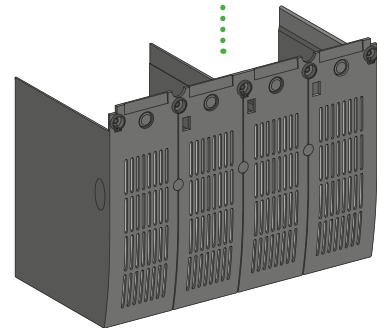

Sealable terminal shields

# Functions and Characteristics

## Accessories and Auxiliaries

### Overview of ComPacT NSX1200 DC Fixed Version

A

#### Connection ► A-32

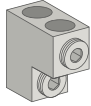

Cable connectors

#### Communication

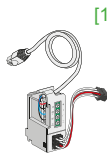

NSX cord

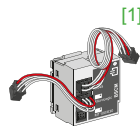

BSCM module

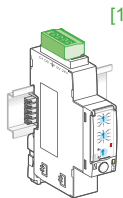

Modbus interface

#### Control accessories ► A-40

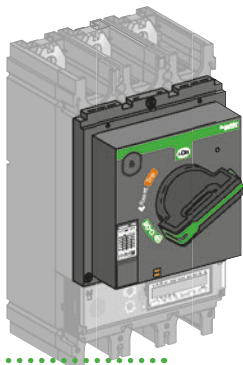

Direct rotary handle

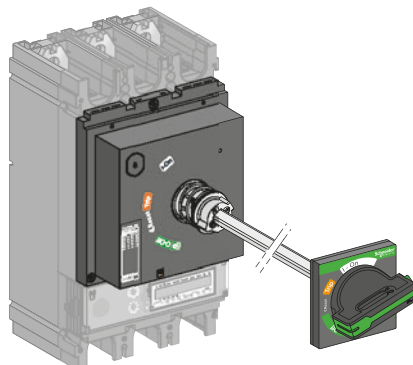

Extended rotary handle

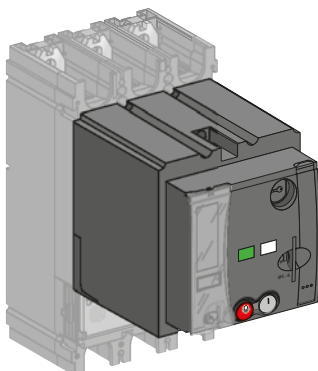

Motor mechanism

[1] See communication chapter.

# Accessories and Auxiliaries

## Overview of ComPacT NSX100 to 630 DC [1] Plug-in and Withdrawable Versions

A

### Insulation accessories

DB437931.ai

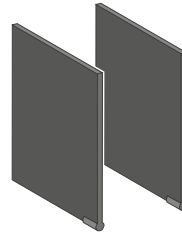

Interphase barriers

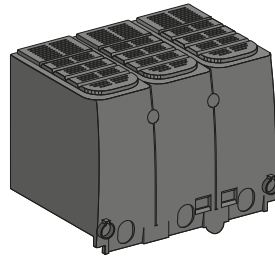

Sealable long terminal shields for plug-in base

### Electrical accessories ► A-34

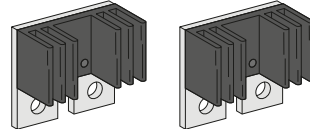

Heat sink

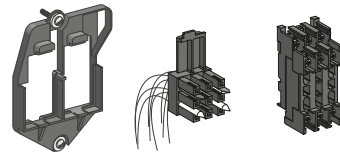

Automatic withdrawable auxiliary connector

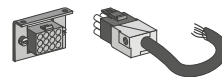

Manual auxiliary connector

### Mechanical accessories ► A-31

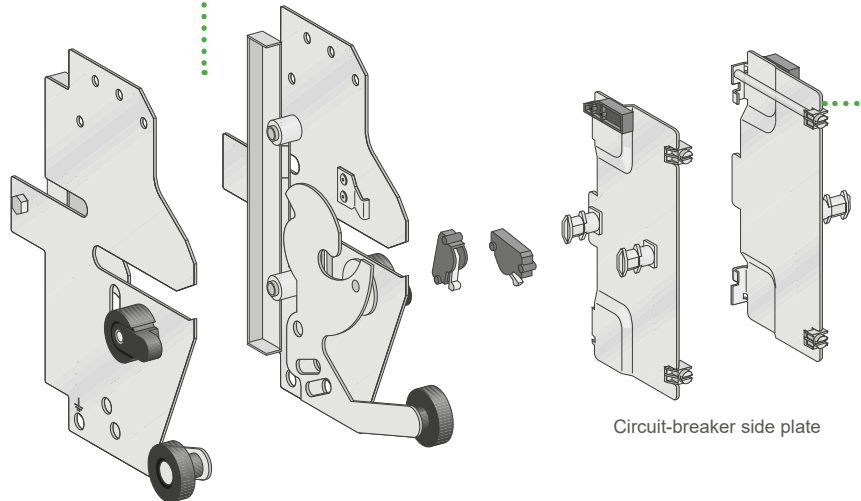

Chassis side plate

Circuit-breaker side plate

[1] Applicable for circuit breaker up to 600 A see page A-16.

# Accessories and Auxiliaries

## Overview of ComPacT NSX100 to 630 DC [1] Plug-in and Withdrawable Versions



### Connection ▶ A-32

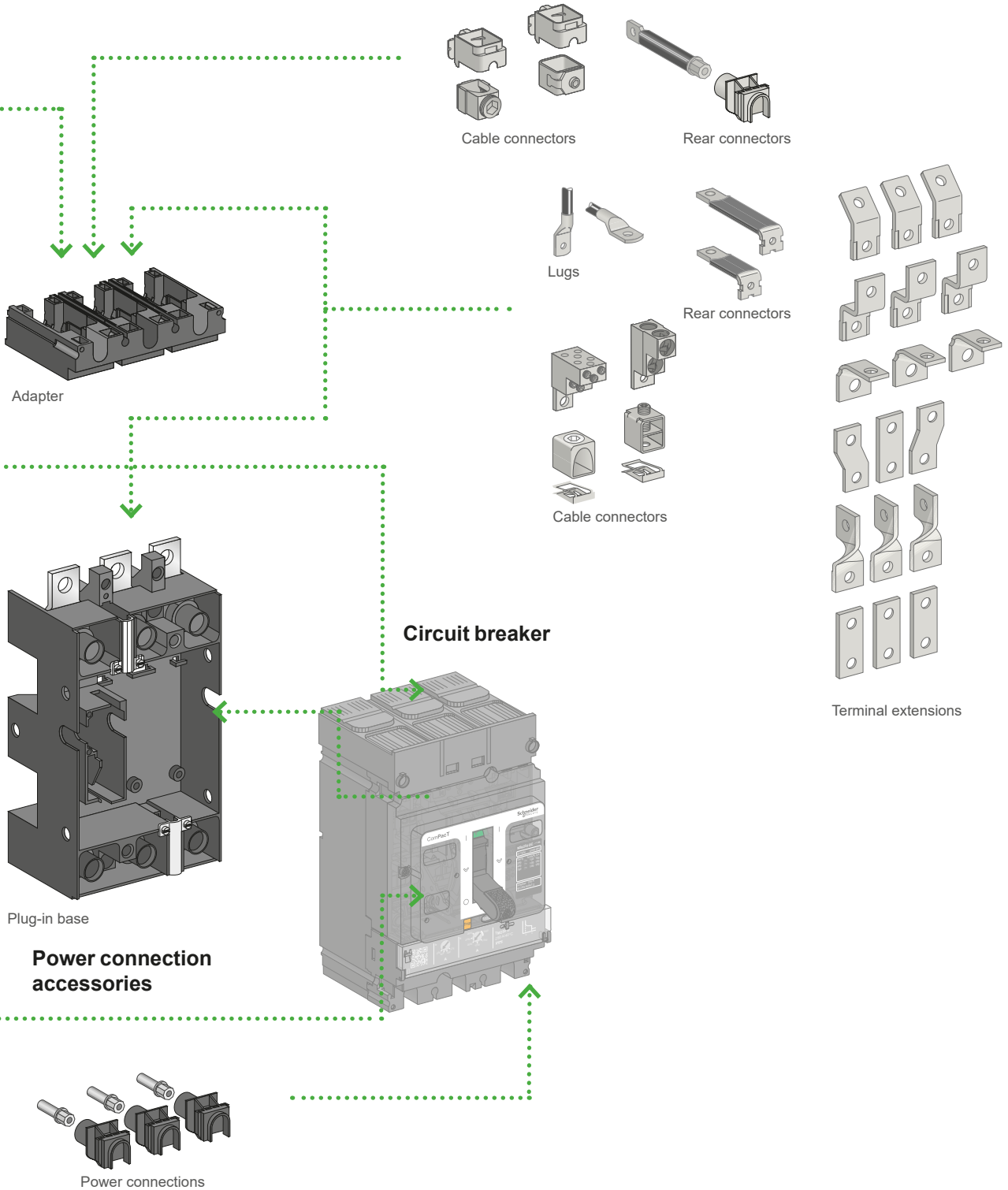



# Electrical and Mechanical Accessories

## ComPacT NSX100 to 1200 DC

ComPacT NSX DC circuit breakers may be installed horizontally, vertically or flat on their back, without derating performance levels.

There are three installation versions:

- Fixed
- Plug-in (on a base)
- Withdrawable (on a chassis).

For the last two, components must be added (base, chassis) to the fixed version. Many connection components are shared by the three versions.

A



Fixed ComPacT NSX250 DC

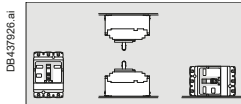

Installation positions



Plug-in ComPacT NSX250 DC

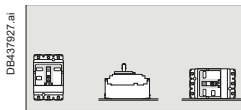

Installation positions

### Fixed Circuit Breakers NSX100 to NSX1200

Fixed circuit breakers are designed for standard connection using bars or cables with lugs. Bare-cable connectors are available for connection to bare copper or aluminium cables.

For connection of large cables, a number of solutions with spreaders may be used for both cables with lugs or bare cables.

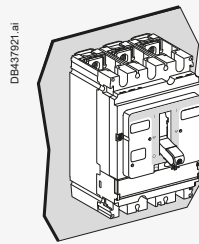

Mounting on a backplate

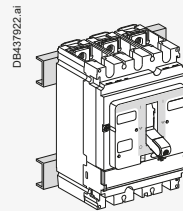

Mounting on rails

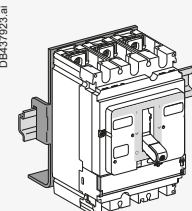

Mounting on DIN rail (with adapter)

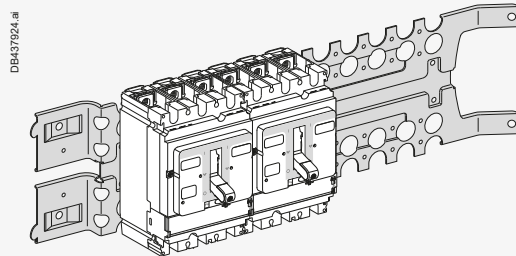

Mounting on a Prisma mounting plate

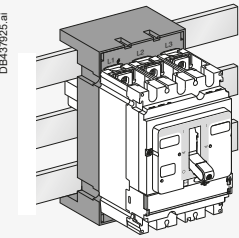

Mounting on busbars with an adapter

### Plug-in Base Circuit Breakers NSX100 to NSX630 [1]

The plug-in version makes it possible to:

- Extract and/or rapidly replace the circuit breaker without having to touch the connections on the base.
- Allow for the addition of future circuits by installing bases that will be equipped with a circuit breaker at a later date.
- Isolate the power circuits when the device is mounted on or through a panel. It acts as a barrier for the connections of the plug-in base. Insulation is made complete by the mandatory short terminal shields on the device. The degrees of protection are:
  - Circuit breaker plugged in = IP4
  - Circuit breaker removed = IP2
  - Circuit breaker removed, base equipped with shutters = IP4.

#### Parts of a plug-in configuration

A plug-in configuration is made by adding a "plug-in kit" to a fixed device. To avoid connecting or disconnecting the power circuits under load conditions, a safety trip causes automatic tripping if the device is ON, before engaging or withdrawing it. The safety trip, supplied with the kit, must be installed on the device. If the device is disconnected, the safety trip does not operate. The device can be operated outside the switchboard.

#### Accessories

Optional insulation accessories are available.

- Terminal shields to protect against direct contact.
- Interphase barriers to reinforce insulation between phases and to protect against direct contact.

#### Mounting

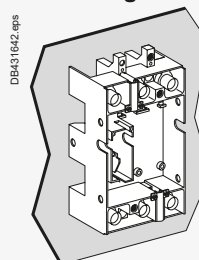

Mounting on a backplate

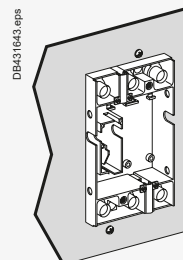

Mounting through a front panel

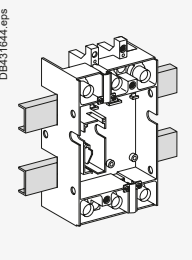

Mounting on rails

[1] Applicable for circuit breaker up to 600 A see page A-14 to A-17.

# Electrical and Mechanical Accessories

## ComPacT NSX100 to 1200 DC

### Withdrawable Circuit Breakers NSX100 to NSX630 [1]

In addition to the advantages provided by the base, installation on a chassis facilitates handling. It offers three positions, with transfer from one to the other after mechanical unlocking:

- Connected: the power circuits are connected
- Disconnected: the power circuits are disconnected, the device can be operated to check auxiliary operation
- Removed: the device is free and can be removed from the chassis.

#### Parts of a withdrawable configuration

A withdrawable configuration requires two side plates installed on the base and two sides plates mounted on the circuit breaker. Similar to the plug-in version, a safety trip causes automatic tripping if the device is ON, before engaging or withdrawing it, and enables device operation in the disconnected position.

#### Accessories

Accessories are the same as for the base, with in addition:

- Auxiliary contacts for installation on the fixed part, indicating the "connected" and "disconnected" positions
- Locking by 1 to 3 padlocks (shackle diameter 5 to 8 mm), to:
  - Prevent insertion for connection
  - Lock the circuit breaker in connected or disconnected position
- Toggle collar for circuit breakers with a toggle mounted through a front panel, intended to maintain the degree of protection whatever the position of the circuit breaker (supplied with a toggle extension)
- Telescopic shaft for extended rotary handles. The door can then be closed with the device in the connected and disconnected positions.

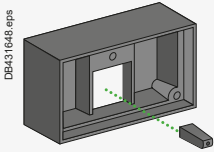

Protection collar for toggle and toggle extension to provide IP4 in the connected and disconnected positions

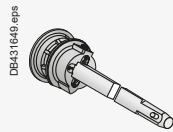

Telescopic shaft

#### Mounting

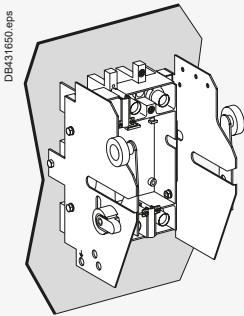

Mounting on a backplate

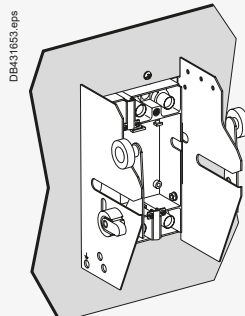

Mounting through a front panel

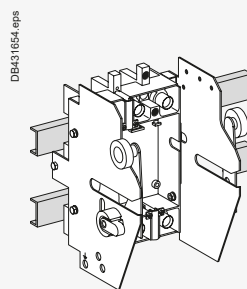

Mounting on rails

[1] Applicable for circuit breaker up to 600 A see page A-14 to A-17.

- Disconnected position - the power circuits are disconnected, but the circuit breaker is still on the chassis and may still be operated (ON, OFF, push-to-trip).
- The circuit breaker may be locked using 1 to 3 padlocks (shackle diameter 5 to 8 mm), to prevent connection.
- The auxiliaries can be tested (with manual auxiliary connector).



Withdrawable ComPacT NSX250 DC



Installation positions

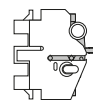

Connected

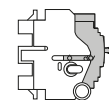

Disconnected

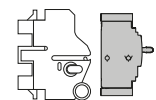

Removed

PB104935 eps

DB437927 ai

DB437928 ai

# Electrical and Mechanical Accessories

## Connection of Fixed Devices

Fixed circuit breakers are designed for standard front connection using bars or cables with lugs.

Cable connectors are available for bare cables. Rear connection is also possible.

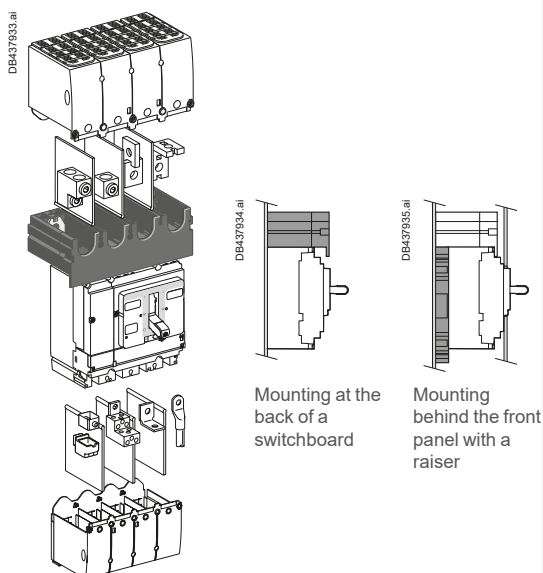
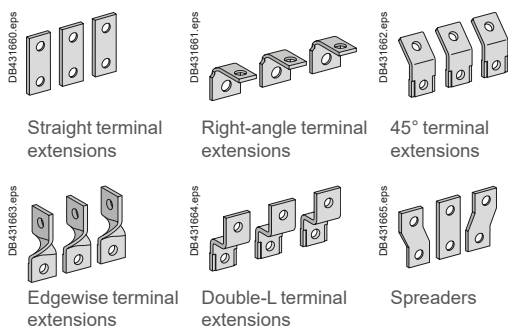
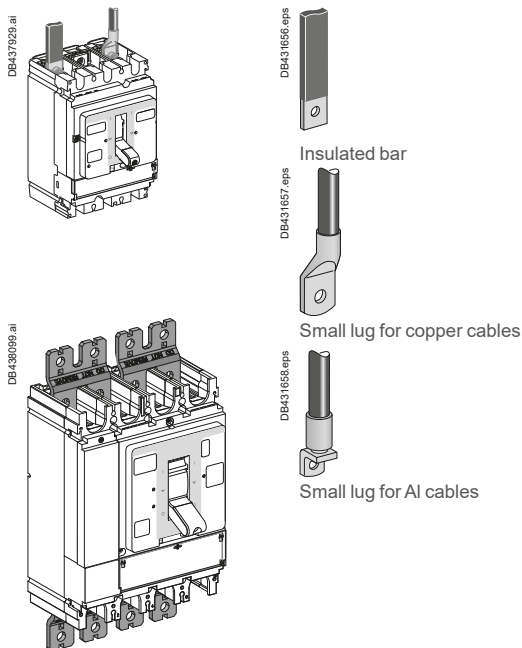

### Front Connection

#### Bars or Cables with Lugs

##### Standard terminals

ComPacT NSX100 to 630 DC come with terminals comprising snap-in nuts with screws:

- ComPacT NSX100/160/250 DC: M8 nuts and screws
- ComPacT NSX400/630 DC: M10 nuts and screws.

These terminals may be used for:

- Direct connection of insulated bars or cables with lugs
- Terminal extensions offering a wide range of connection possibilities.

Interphase barriers or terminal shields are recommended. They are mandatory for certain connection accessories (in which case the interphase barriers are provided).

##### Bars

When the switchboard configuration has not been tested, insulated bars are mandatory.

##### Maximum size of bars

ComPacT NSX DC circuit breaker		100 to 250	400 to 630	1200
Without spreaders	pitch (mm)	35	45	45
	maximum bar size (mm)	20 x 2	32 x 6	2 x (32 x 6)
With spreaders	pitch (mm)	45	52.5	-
	maximum bar size (mm)	32 x 2	40 x 6	-

##### Crimp lugs

There are two models, for aluminium and copper cables.

It is necessary to use narrow lugs, compatible with device connections. They must be used with interphase barriers or long terminal shields. The lugs are supplied with interphase barriers and may be used for the types of cables listed below.

##### Cable sizes for connection using lugs

ComPacT NSX DC circuit breaker		100 to 250	400 to 630	630 to 1200
Copper cables	size (mm <sup>2</sup> )	120, 150, 185	240, 300	185, 2 x 185
	crimping	hexagonal barrels or punching		
Aluminium cables	size (mm <sup>2</sup> )	120, 150, 185	240, 300	185, 2 x 185
	crimping	hexagonal barrels		

##### Terminal extensions

Extensions with anti-rotation ribs can be attached to the standard terminals to provide numerous connection possibilities in little space:

- Straight terminal extensions
- Right-angle terminal extensions
- Edgewise terminal extensions
- Double-L extensions
- 45° extensions.

##### Spreaders

Spreaders may be used to increase the pitch:

- NSX100 to 250 DC: the 35 mm pitch can be increased to 45 mm
- NSX400/630 DC: the 45 mm pitch can be increased to 52 or 70 mm.

Bars, cable lugs or cable connectors can be attached to the ends.

##### One-piece spreader for NSX100 to 250 DC

Connection of large cables may require an increase in the distance between the device terminals.

The one-piece spreader is the means to:

- Increase the 35 mm pitch of the NSX100 to 250 DC circuit breaker terminals to the 45 mm pitch of a NSX400/630 DC device
- Use all the connection and insulation accessories available for the next largest frame size (lugs, connectors, spreaders, right-angle and edgewise terminal extensions, terminal shields and interphase barriers).

It may also be used for ComPacT INS switch-disconnectors.

Equipped with a single-piece spreader, ComPacT NSX DC devices can be mounted:

- At the back of a switchboard
- Behind the front panel with a raiser.

The one-piece spreader is also the means to:

- Align devices with different frame sizes in the switchboard
- Use the same mounting plate, whatever the device.

##### Pitch (mm) depending on the type of spreader

ComPacT NSX DC circuit breaker		100 to 250	400 to 630
Without spreaders		35	45
With spreaders		45	52.5 or 70
With one-piece spreader		45	-

# Electrical and Mechanical Accessories

## Connection of Fixed Devices

### Bare Cables

For bare cables (without lugs), the prefabricated bare-cable connectors may be used for both copper and aluminium cables.

#### 1-cable connector for ComPacT NSX100 to 250 DC

The connectors snap directly on to the device terminals and are fixed by clips to right-angle and straight terminal extensions as well as spreaders.

#### 1-cable connector for ComPacT NSX400 to 630 DC

The connectors are screwed directly to the device terminals.

#### 2-cable connector for ComPacT NSX100 to 250 and 400/630/1200 DC

The connectors are screwed to device terminals or right-angle terminal extensions.

#### Distribution connectors for ComPacT NSX100 to 250 DC

These connectors are screwed directly to device terminals. Interphase barriers are supplied with distribution connectors, but may be replaced by long terminal shields. Each connector can receive six cables with cross-sectional areas ranging from 1.5 to 35 mm<sup>2</sup> each.

### Maximum size of cables depending on the type of connector

ComPacT NSX DC circuit breaker		100/160	250	400	630	1200
Steel connectors	1.5 to 95 mm <sup>2</sup>	●				
Aluminium connectors	25 to 95 mm <sup>2</sup>	●	●			
	120 to 185 mm <sup>2</sup>	●	●			
	2 cables 50 to 120 mm <sup>2</sup>	●	●			
	2 cables 35 to 240 mm <sup>2</sup>			●	●	●
	35 to 300 mm <sup>2</sup>			●	●	
Distribution connectors	6 cables 35 mm <sup>2</sup>	●	●			

### Rear Connection (up to Rated Current 600 A)

Device mounting on a backplate with suitable holes enables rear connection.

#### Bars or Cables with Lugs

Rear connections for bars or cables with lugs are available in two lengths. Bars may be positioned flat, on edge or at 45° angles depending on how the rear connections are positioned.

The rear connections are simply fitted to the device connection terminals. All combinations of rear connection lengths and positions are possible on a given device.

#### Bare Cables

For the connection of bare cables, the 1-cable connectors for ComPacT NSX100 to 250 DC may be secured to the rear connections using clips.

### Accessories for Series and Parallel Connection (up to Rated Current 600 A)

A limited number of accessories can be used to optimize series and parallel connection of poles.

#### Accessories for Series Connection

These include series connection plates, equipped with heat sinks.

#### Accessories for Parallel Connection

Parallel pole connection accessories are identical to those for series connections. They are equipped with heat sinks. Customer connections are made directly to the connection plates after removing the heat sinks.

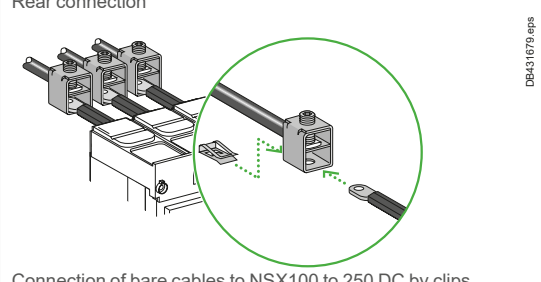
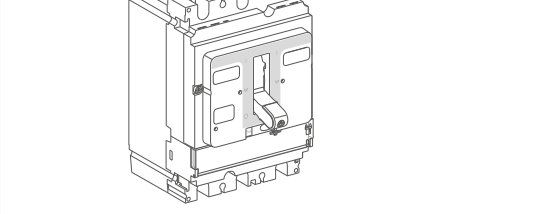
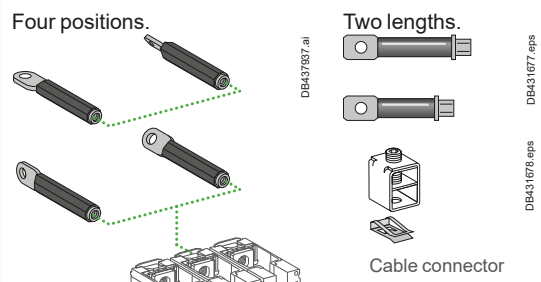
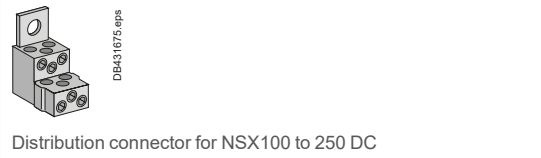
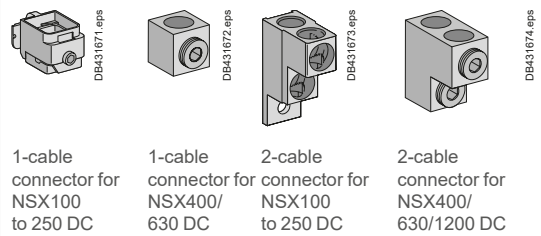
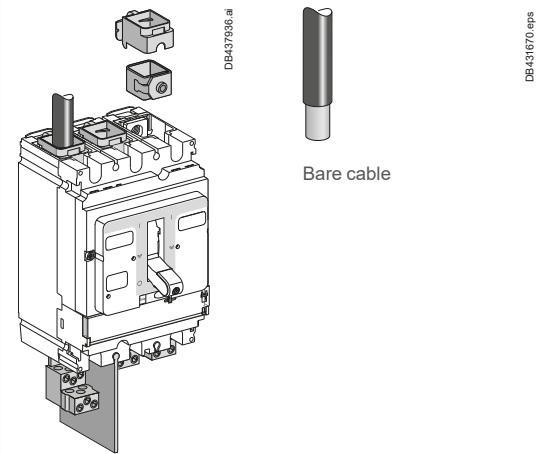
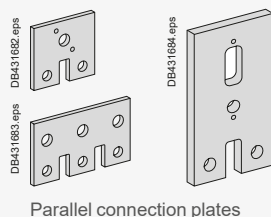
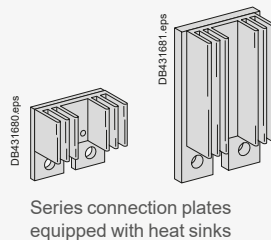



# Electrical and Mechanical Accessories

## Connection of Electrical Auxiliaries

A

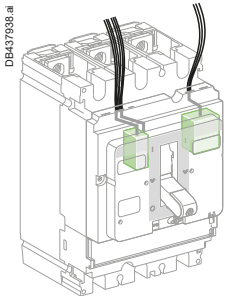

Fixed ComPacT NSX DC

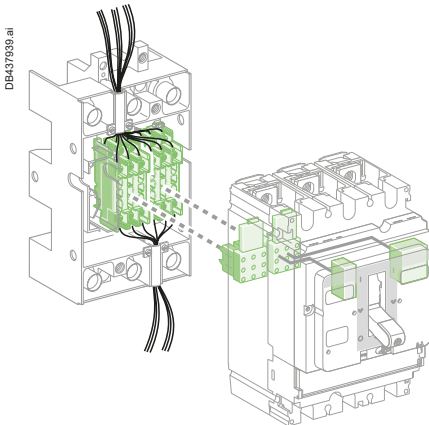

Plug-in/withdrawable ComPacT NSX DC

### Fixed ComPacT NSX100-250 DC

Auxiliary circuits exit the device through a knock-out in the front cover.

### Withdrawable or Plug-in ComPacT NSX DC

#### Automatic Auxiliary Connectors

Auxiliary circuits exit the circuit breaker via one to three automatic auxiliary connectors (nine wires each). These are made up of:

- A moving part, connected to the circuit breaker via a support (one support per circuit breaker)
- A fixed part, mounted on the plug-in base, equipped with connectors for bare cables up to 2.5 mm<sup>2</sup>.

MicroLogic trip unit options are also wired via the automatic auxiliary connectors.

#### Selection of automatic auxiliary connectors

Depending on the functions installed, one to three automatic auxiliary connectors are required.

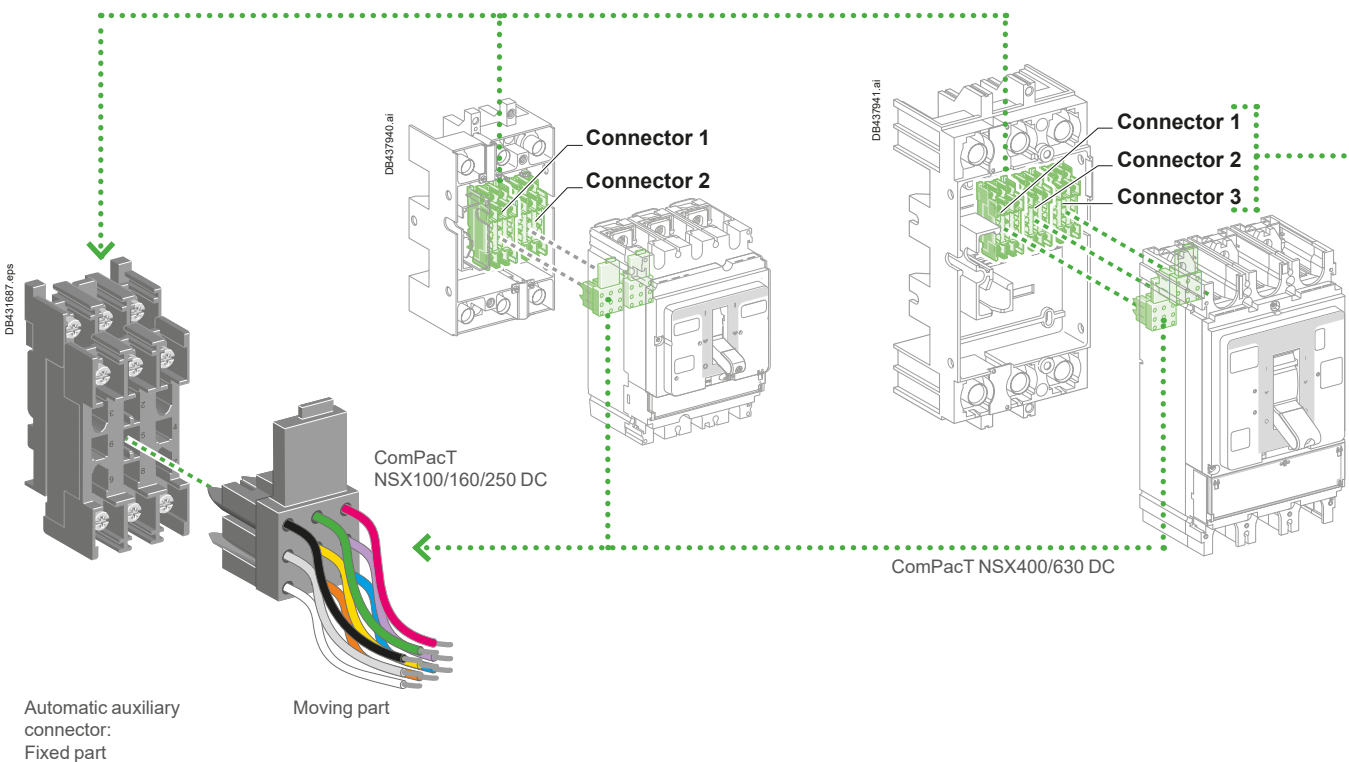



# Electrical and Mechanical Accessories

## Connection of Electrical Auxiliaries

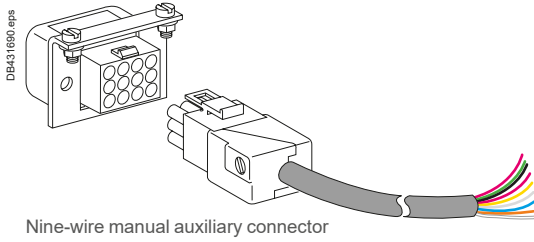

### Withdrawable ComPacT NSX DC

#### Manual Auxiliary Connectors

As an option to the automatic auxiliary connectors, withdrawable circuit breakers may be equipped with one to three plugs with nine wires each. In "disconnected" position, the auxiliaries remain connected. They can then be tested by operating the device.

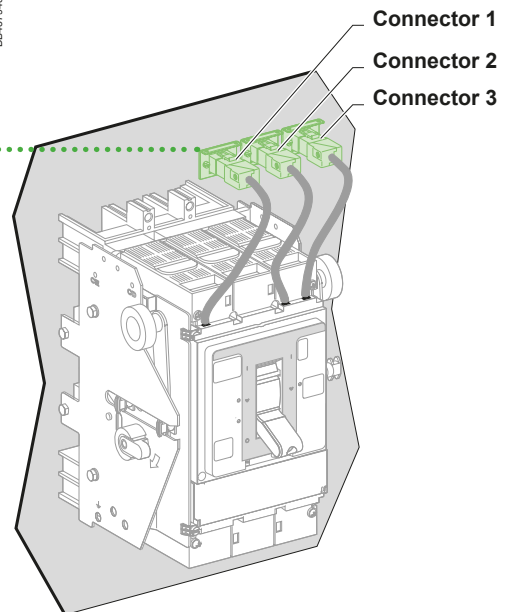
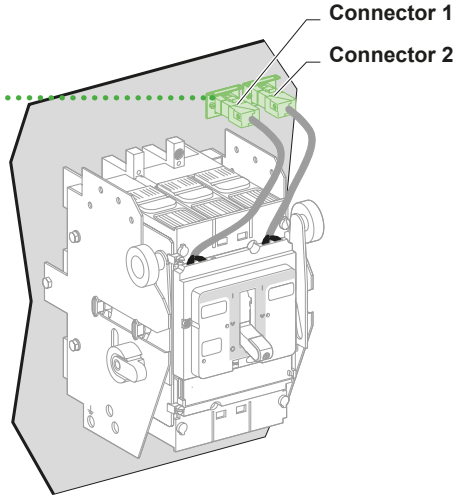

Each auxiliary is equipped with a terminal block with numbered terminals for connection of wires up to:

- 1.5 mm<sup>2</sup> for auxiliary contacts and voltage releases
- 2.5 mm<sup>2</sup> for the motor mechanism module.

Circuit breaker	Connector 1	Connector 2	Connector 3
	OF1 MN/MX SD	OF2 SDE NSX cord MT 24 V DC	OF3
NSX100/160/250 DC	●	●	-
NSX400/630 DC	●	●	●

MT: motor mechanism



# Electrical and Mechanical Accessories

## Selection of Auxiliaries for ComPacT NSX100/160/250 DC

PB 120488.eps



A

### Remote Tripping

MX or MN voltage releases are used to trip the circuit breaker.

#### MN Undervoltage Release

This release trips the circuit breaker when the control voltage drops below a tripping threshold:

- Tripping threshold between 0.35 and 0.7 times the rated voltage.
- Circuit breaker closing is possible if the voltage exceeds 0.85 times the rated voltage. For a lower value, circuit breaker closing cannot be ensured.

Circuit breaker tripping by an MN release meets the requirements of standard IEC 60947-2.

#### Time-Delay Unit for an MN Release

Eliminates nuisance tripping due to transient voltage dips lasting 200 ms.

It is used in conjunction with:

- A 250 V DC MN release, control voltage 220/240 V AC
- A 48 V DC MN release, control voltage 48 V AC.

#### MX Shunt Release

Trips the circuit breaker when the control voltage rises above  $0.7 \times U_n$ .

Control signals can be of the impulse type ( $\geq 20$  ms) or maintained.

#### Operation

When the circuit breaker has been tripped by an MN or MX release, it must be reset locally.

MN or MX tripping takes priority over manual closing.

In the presence of a standing trip order, closing of the contacts, even temporary, is not possible.

#### Mechanical Characteristics

- Endurance is equal to 50 % of the mechanical endurance of the circuit breaker.
- The releases clip in behind the front cover.
- Connection using wires up to  $1.5 \text{ mm}^2$ , to integrated terminal blocks.

#### Electrical Characteristics

- Consumption:
  - Pick-up (MX):  $< 30 \text{ VA}$
  - Seal-in (MN and MNR):  $< 5 \text{ VA}$ .
- Response time:  $< 50 \text{ ms}$ .

## NA, TMD, TMG

### Standard

DB431683.eps

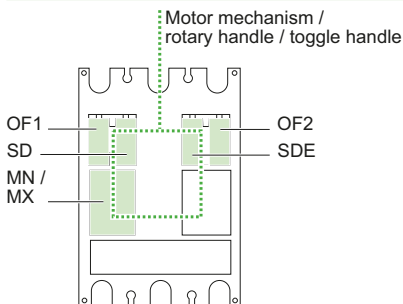

DB437944.ai

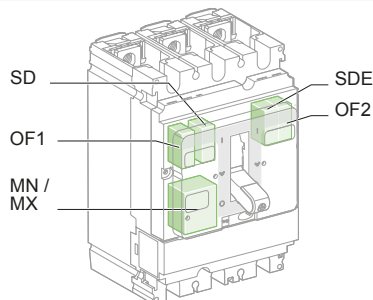

# Electrical and Mechanical Accessories

## Selection of Auxiliaries for ComPacT NSX100/160/250 DC

### Communication

Communication requires specific auxiliaries (see page A-42).

#### Communication of status indications <sup>[1]</sup>

- 1 BSCM module.
- 1 NSX cord (internal terminal block) for both communication and 24 V DC supply to the BSCM.

Communication of status conditions is compatible with a toggle handle and a rotary handle.

#### Communication of status indications and controls

This requires, in addition to the previous auxiliaries:

- 1 IFM connected to the BSCM.



### TMD, TMG

#### Communication of status indications <sup>[1]</sup>

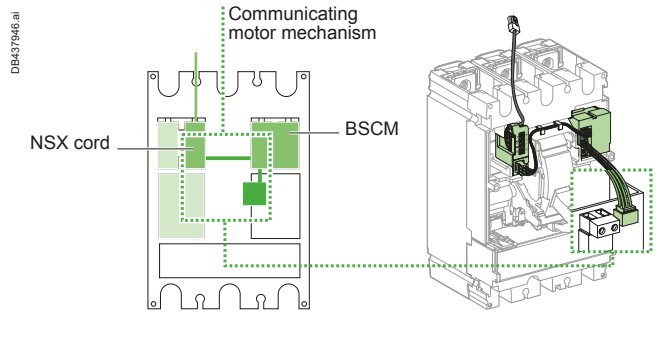
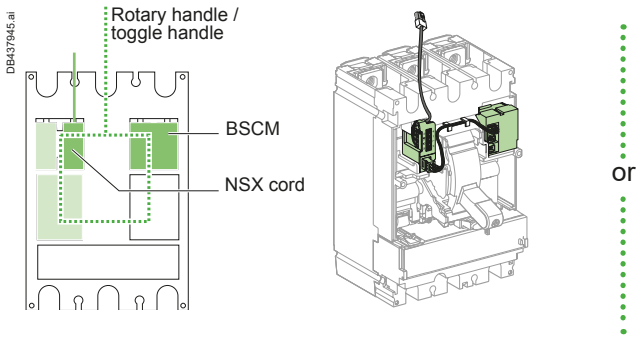

[1] ComPacT NSX100-250 DC only.

# Electrical and Mechanical Accessories

## Selection of Auxiliaries for ComPacT NSX400/630/1200 DC

A

### Standard

All ComPacT NSX400/630/1200 DC circuit breakers and switch-disconnectors have slots for the electrical auxiliaries listed below.

#### 5 indication contacts (see page A-39)

- 3 ON/OFF (OF1, OF2, OF3)
- 1 trip indication (SD)
- 1 fault-trip indication (SDE)

#### 1 remote-tripping release (see page A-43)

- Either 1 MN undervoltage release
- Or 1 MX shunt release

All these auxiliaries may be installed with a motor mechanism or a rotary handle or toggle handle.

### NSX400/630/1200 DC

#### Standard

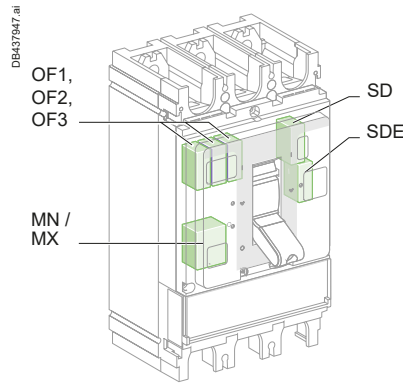
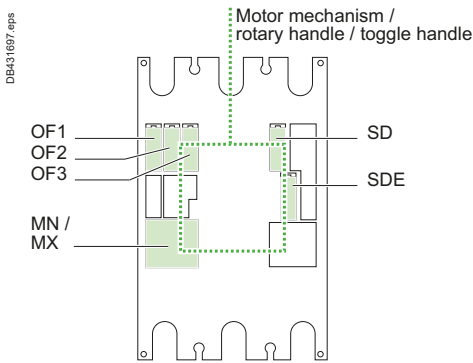

#### Communication of status indications

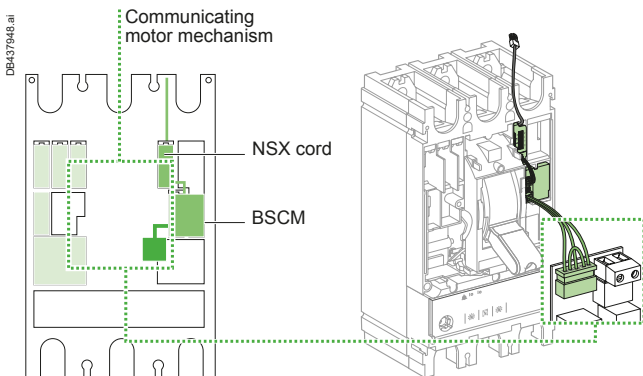

#### Communication of status indications and controls

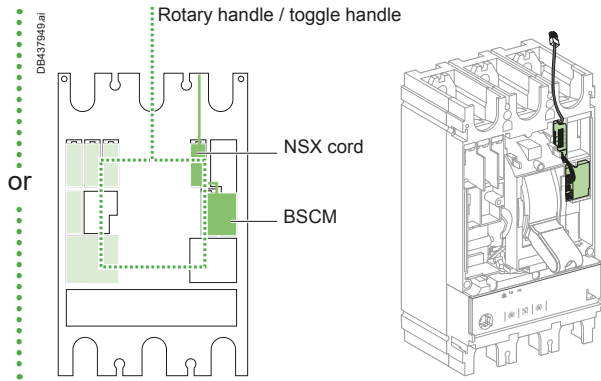

# Electrical and Mechanical Accessories

## Indication Contacts for ComPacT NSX DC

One contact model provides circuit breaker status indications (OF - SD - SDE).  
 An early-make or early-break contact, in conjunction with a rotary handle, can be used to anticipate device opening or closing.  
 A CE/CD contact indicates that the chassis is connected/disconnected.

These common-point changeover contacts provide remote circuit breaker status information.  
 They can be used for indications, electrical locking, relaying, etc.  
 They comply with the IEC 60947-5 international recommendation.

### Functions

#### Breaker-status indications, during normal operation or after a fault

A single type of contact provides all the different indication functions:

- OF (ON/OFF) indicates the position of the circuit breaker contacts
- SD (trip indication) indicates that the circuit breaker has tripped due to:
  - An overload
  - A short-circuit
  - Operation of a voltage release
  - Operation of the "push to trip" button
  - Disconnection when the device is ON.

The SD contact returns to de-energized state when the circuit breaker is reset.

- SDE (fault-trip indication) indicates that the circuit breaker has tripped due to:
  - An overload
  - A short-circuit.

The SD contact returns to de-energized state when the circuit breaker is reset.

#### Rotary-handle position contact for early-make or early-break functions

- CAM (early-make or early-break function) contacts indicate the position of the rotary handle.

They are used in particular for advanced opening of safety trip devices (early break) or to energize a control device prior to circuit breaker closing (early make).

#### Chassis-position contacts

- CE/CD (connected/disconnected) contacts are microswitch-type carriage switches for withdrawable circuit breakers.

### Installation

- OF, SD, SDE functions: a single type of contact provides all these different indication functions, depending on where it is inserted in the device. The contacts clip into slots behind the front cover of the circuit breaker.

The SDE function on a ComPacT NSX100 - 250 DC equipped with a thermal-magnetic trip unit requires the SDE actuator.

- CAM function: the contact fits into the rotary-handle unit (direct or extended).
- CE/CD function: the contacts clip into the fixed part of the chassis.

### Electrical Characteristics of Auxiliary Contacts

Contacts		Standard				Low level			
Types of contacts		All				OF, SD, SDE			
Rated thermal current (A)		6				5			
Minimum load		100 mA at 24 V DC				1 mA at 4 V DC			
Utilization cat. (IEC 60947-5-1)		AC12	AC15	DC12	DC14	AC12	AC15	DC12	DC14
Operational current (A)	24 V AC/DC	6	6	6	1	5	3	5	1
	48 V AC/DC	6	6	2.5	0.2	5	3	2.5	0.2
	110 V AC/DC	6	5	0.6	0.05	5	2.5	0.6	0.05
	220/240 V AC	6	4	-	-	5	2	-	-
	250 V DC	-	-	0.3	0.03	5	-	0.3	0.03
	380/440 V AC	6	2	-	-	5	1.5	-	-
480 V AC	6	1.5	-	-	5	1	-	-	
660/690 V AC	6	0.1	-	-	-	-	-	-	



Indication contacts

LV429454.eps

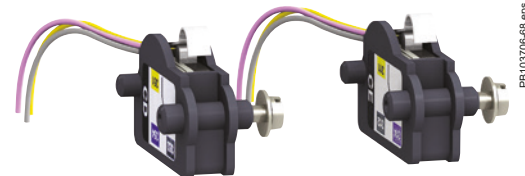

CE/CD carriage switches

PB103706-08.eps



# Electrical and Mechanical Accessories

## Rotary Handles for ComPacT NSX DC

There are two types of rotary handle:

- Direct rotary handle
- Extended rotary handle.

There are two models:

- Standard with a black handle
- Red handle and yellow front for machine-tool control.

A



ComPacT NSX DC with a rotary handle



ComPacT NSX DC with an MCC rotary handle



ComPacT NSX DC with a CNOMO machine-tool rotary handle

### Direct Rotary Handle

#### Standard Handle

Degree of protection IP40, IK07.

The direct rotary handle maintains:

- Visibility of and access to trip unit settings
- Suitability for isolation
- Indication of the three positions O (OFF), I (ON) and tripped
- Access to the "push to trip" button.

#### Device locking

The rotary handle facilitates circuit breaker locking.

- Padlocking:
    - Standard situation, in the OFF position, using 1 to 3 padlocks, shackle diameter 5 to 8 mm, not supplied
    - With a simple modification, in the ON and OFF positions. Locking in the ON position does not prevent free circuit breaker tripping if a fault occurs. In this case, the handle remains the ON position after the circuit breaker tripping. Unlocking is required to go to the tripped then the OFF position.
  - Keylock (and padlock).
- It is possible to install a Ronis or Profalux keylock (optional) on the base of the handle to obtain the same functions as with a padlock.

#### Early-make or early-break contacts (optional)

Early-make and/or early-break contacts may be used with the rotary handle. It is thus possible to:

- Supply an MN undervoltage release before the circuit breaker closes
- Open the contactor control circuit before the circuit breaker opens.

#### MCC Switchboard Control

Control of an MCC switchboard is achieved by adding a kit to the standard handle. In addition to the standard functions, the kit offers the characteristics listed below.

#### Higher degree of protection IP

Degree of protection IP43, IK07.

The IP is increased by a built-in gasket.

#### Door locking depending on device position

- The door cannot be opened if the circuit breaker is ON or in the tripped position. For exceptional situations, door locking can be temporarily disabled with a tool to open the door when the circuit breaker is closed. This operation is not possible if the handle is locked by a padlock.
- Circuit breaker closing is disabled if the door is open. This function can be deactivated.

#### Machine-Tool Control in Compliance with CNOMO

Control of a machine-tool is achieved by adding a kit to the standard handle. In addition to the standard functions, the kit offers the characteristics listed below.

#### Enhanced waterproofness and mechanical protection

- Degree of protection IP54, IK08.
- Compliance with CNOMO E03.81.501N.



# Electrical and Mechanical Accessories

## Rotary Handles for ComPacT NSX DC

### Extended Rotary Handle

Degree of protection IP55, IK08.

The extended rotary handle makes it possible to operate circuit breakers installed at the back of switchboards, from the switchboard front.

It maintains:

- Visibility of and access to trip unit settings
- Suitability for isolation
- Indication of the three positions O (OFF), I (ON) and tripped.

#### Mechanical door locking when device closed

A standard feature of the extended rotary handle is a locking function, built into the shaft, that disables door opening when the circuit breaker is in the ON or tripped positions.

Door locking can be temporarily disabled with a tool to open the door without opening the circuit breaker. This operation is not possible if the handle is locked by a padlock.

#### Voluntary disabling of mechanical door locking

A modification to the handle, that can be carried out on site, completely disables door locking, including when a padlock is installed on the handle. The modification is reversible.

When a number of extended rotary handles are installed on a door, this disabling function is the means to ensure door locking by a single device.

#### Device and door padlocking

Padlocking locks the circuit breaker handle and disables door opening:

- Standard situation, in the OFF position, using 1 to 3 padlocks, shackle diameter 5 to 8 mm, not supplied
- With a simple modification, in the ON and OFF positions. Locking in the ON position does not prevent free circuit breaker tripping if a fault occurs.

In this case, the handle remains in the ON position after the circuit breaker tripping. Unlocking is required to go to the tripped then the OFF position.

If the door controls were modified to voluntarily disable door locking, padlocking does not lock the door, but does disable handle operation of the device.

#### Device locking using a keylock inside the switchboard

It is possible to install a Ronis or Profalux keylock (optional) on the base of the rotary handle to lock the device in the OFF position or in either the ON or OFF positions.

#### Accessory for device operation with the door open

When the device is equipped with an extended rotary handle, a control accessory mounted on the shaft makes it possible to operate the device with the door open.

- The device can be padlocked in the OFF position.
- The accessory complies with UL508.

#### Early-make or early-break contacts (optional)

The extended rotary handle offers the same possibilities with early-make and/or early-break contacts as the standard rotary handle.

#### Parts of the extended rotary handles

- A unit that replaces the front cover of the circuit breaker (secured by screws).
- An assembly (handle and front plate) on the door that is always secured in the same position, whether the circuit breaker is installed vertically or horizontally.
- An extension shaft that must be adjusted to the distance. The min/max distance between the back of circuit breaker and door is:
  - 185...600 mm for ComPacT NSX100 to 250 DC
  - 209...600 mm for ComPacT NSX400/630/1200 DC.

For withdrawable devices, the extended rotary handle is also available with a telescopic shaft to compensate for device disconnection. In this case, the min/max distances are:

- 248...600 mm for ComPacT NSX100 to 250 DC
- 272...600 mm for ComPacT NSX400/630/1200 DC.

### Manual Source-Changeover Systems

An additional accessory interlocks two devices with rotary handles to create a source-changeover system. Closing of one device is possible only if the second is open.

This function is compatible with direct or extended rotary handles.

Up to three padlocks can be used to lock in the OFF or ON position.

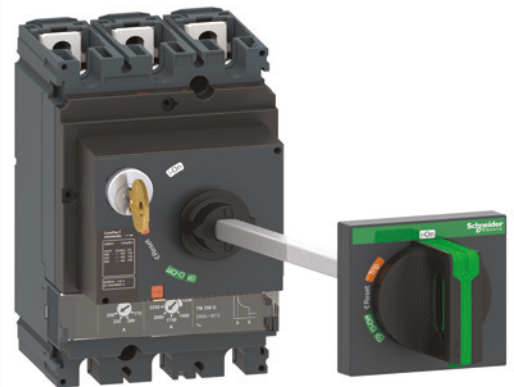

ComPacT NSX DC with an extended rotary handle installed at the back of a switchboard, with the keylock option and key



PB123900.eps

A

PB123901.eps

PB113418.eps

# Electrical and Mechanical Accessories

## Motor Mechanism for ComPacT NSX DC



ComPacT NSX250 DC with motor mechanism

A

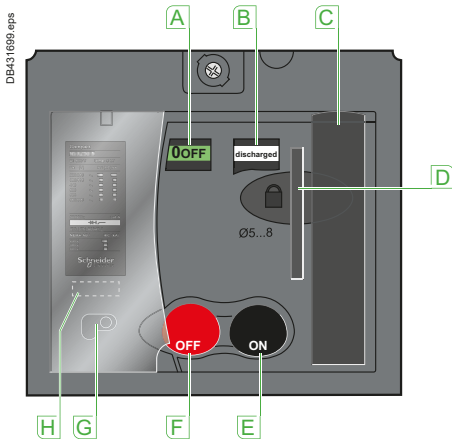

- A** Position indicator (positive contact indication)
- B** Spring status indicator (charged, discharged)
- C** Manual spring-charging lever
- D** Keylock device (optional)  
Locking device (OFF position), using 1 to 3 padlocks, shackle diameter 5 to 8 mm, not supplied
- E** I (ON) pushbutton
- F** O (OFF) pushbutton
- G** Manual/auto mode selection switch. The position of this switch can be indicated remotely
- H** Operation counter (ComPacT NSX400/630 DC)

When equipped with a **motor mechanism** module, ComPacT NSX DC circuit breakers feature very high mechanical endurance as well as easy and reliable operation:

- All circuit breaker indications and information remain visible and accessible, including trip unit settings and indications
- Suitability for isolation is maintained and padlocking remains possible
- Double insulation of the front face.

A specific motor mechanism is required for operation via the communication function [1]. This **communicating motor mechanism** must be connected to the BSCM module to receive the opening and closing orders. Operation is identical to that of a standard motor mechanism.

### Applications

- Local motor-driven operation, centralized operation, automatic distribution control.
- Normal/standby source changeover or switching to a replacement source  
For availability and energy cost optimization.
- Load shedding and reconnection.
- Synchrocoupling.

### Operation

The type of operation is selected using the manual/auto mode selection switch (7). A transparent, lead-seal cover controls access to the switch.

#### Automatic

When the switch is in the "auto" position, the ON/OFF (I/O) buttons and the charging lever on the mechanism are locked.

- Circuit breaker ON and OFF controlled by two impulse-type or maintained signals.
- Automatic spring charging following voluntary tripping (by MN or MX), with standard wiring.
- Mandatory manual reset following tripping due to an electrical fault.

#### Manual

When the switch is in the "manual" position, the ON/OFF (I/O) buttons may be used. A microswitch linked to the manual position can remote the information.

- Circuit breaker ON and OFF controlled by 2 pushbuttons I/O.
- Recharging of stored-energy system by pumping the lever 8 times.
- Padlocking in OFF position.

### Installation and Connections

All installation (fixed, plug-in/withdrawable) and connection possibilities are maintained.

Motor mechanism module connections are made behind its front cover to integrated terminals, for cables up to 2.5 mm<sup>2</sup>.

### Optional Accessories

- Keylock for locking in OFF position.
- Operations counter for the ComPacT NSX400/630 DC, indicating the number of ON/OFF cycles. Must be installed on the front of the motor mechanism module.

### Characteristics

Motor mechanism		MT100 to MT630	
Response time (ms)	opening	< 600	
	closing	< 80	
Operating frequency	cycles/minute max.	4	
Control voltage (V)	DC	24/30 - 48/60 - 110/130 - 250	
	AC 50/60 Hz	48 (50 Hz) - 110/130 - 220/240 - 380/440	
Consumption [1]	DC (W)	opening	≤ 500
		closing	≤ 500
	AC (VA)	opening	≤ 500
		closing	≤ 500

[1] For NSX100 to 250 DC, the inrush current is 2 In for 10 ms.

### Electrical Endurance

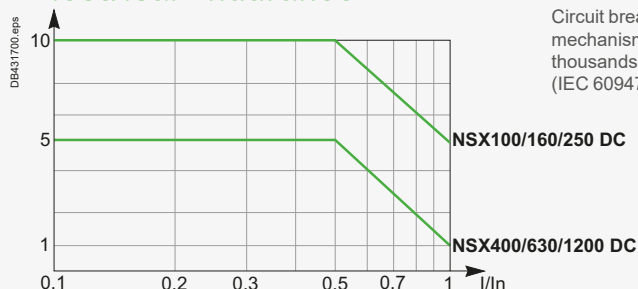

Circuit breaker + motor mechanism module, in thousands of operations (IEC 60947 2), at 440 V

[1] NSX100-250 DC only.

# Electrical and Mechanical Accessories

## Remote Tripping for ComPacT NSX DC

MX or MN voltage releases are used to trip the circuit breaker. They serve primarily for remote, emergency-off commands.

It is advised to test the system every six months.

### MN Undervoltage Release

The MN release opens the circuit breaker when its supply voltage drops to a value below 35 % of its rated voltage  $U_n$ .

Undervoltage tripping, combined with an emergency-off button, provides fail-safe tripping. The MN release is continuously supplied, i.e. if supply is interrupted:

- Either voluntarily, by the emergency-off button
- Or accidentally, through loss of power or faulty wiring, the release provokes opening of the circuit breaker.

### Opening conditions

Circuit breaker tripping by an MN release meets the requirements of standard IEC 60947-2.

- Automatic opening of the circuit breaker is ensured when the continuous voltage supply to the release  $U \leq 0.35 \times U_n$ .
- If the supply voltage is between 0.35 and 0.7  $U_n$ , opening is possible, but not guaranteed. Above 0.7  $U_n$ , opening does not take place.

### Closing conditions

If there is no supply to the MN release, it is impossible to close the circuit breaker, either manually or electrically. Closing is ensured when the voltage supply to the release  $U \geq 0.85 \times U_n$ . Below this threshold, closing is not ensured.

### Characteristics

Power supply	V AC	50/60 Hz: 24 - 48 - 100/130 - 200/240
		50 Hz: 380/415    60 Hz: 208/277
Operating threshold	V DC	12 - 24 - 30 - 48 - 60 - 125 - 250
	Opening	0.35 to 0.7 $U_n$
	Closing	0.85 $U_n$
Operating range		0.85 to 1.1 $U_n$
Consumption (VA or W)		Pick-up: 10 - Hold: 5
Response time (ms)		50

### Time-delay unit for an MN release

A time delay unit for the MN release eliminates the risk of nuisance tripping due to a transient voltage dip. For shorter micro-outages, a system of capacitors provides temporary supply to the MN at  $U > 0.7$  to ensure non tripping.

The correspondence between MN releases and time-delay units is shown below.

Power supply	Corresponding MN release
<b>Unit with fixed delay 200 ms</b>	
48 V AC	48 V DC
220/240 V AC	250 V DC
<b>Unit with adjustable delay <math>\geq 200</math> ms</b>	
48 - 60 V AC/DC	48 V DC
100 - 130 V AC/DC	125 V DC
220 - 250 V AC/DC	250 V DC

### MX Shunt Release

The MX release opens the circuit breaker via an impulse-type ( $\geq 20$  ms) or maintained order.

### Opening conditions

When the MX release is supplied, it automatically opens the circuit breaker. Opening is ensured for a voltage  $U \geq 0.7 \times U_n$ .

### Characteristics

Power supply	V AC	50/60 Hz: 24 - 48 - 100/130 - 200/240
		50 Hz: 380/415    60 Hz: 208/277
Operating range	V DC	12 - 24 - 30 - 48 - 60 - 125 - 250
		0.7 to 1.1 $U_n$
Consumption (VA or W)		Pick-up: 10
Response time (ms)		50

### Circuit Breaker Control by MN or MX

When the circuit breaker has been tripped by an MN or MX release, it must be reset before it can be reclosed.

MN or MX tripping takes priority over manual closing.

In the presence of a standing trip order, closing of the contacts, even temporary, is not possible.

Connection using wires up to 1.5 mm<sup>2</sup> to integrated terminal blocks.



MX or MN voltage release

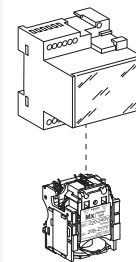
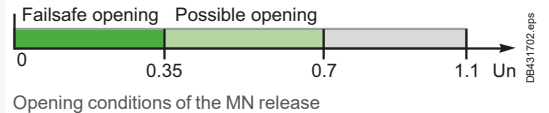

MN release with a time-delay unit

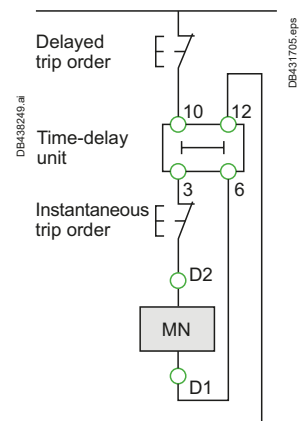

Wiring diagram for emergency-off function with MN + time-delay unit

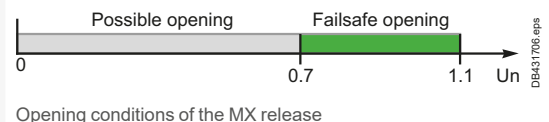

Opening conditions of the MX release

**Note:** Circuit breaker opening using an MN or MX release must be reserved for safety functions. This type of tripping increases wear on the opening mechanism. Repeated use reduces the mechanical endurance of the circuit breaker by 50 %.

# Electrical and Mechanical Accessories

## Locks for ComPacT NSX DC

A

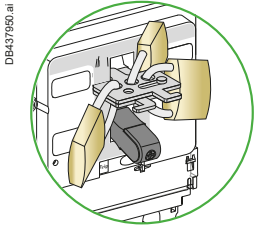

Toggle locking using padlocks and an accessory:  
Removable device

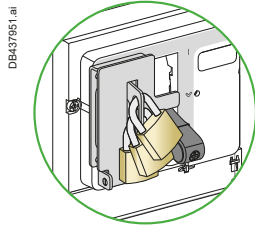

Fixed device attached to the case [3]

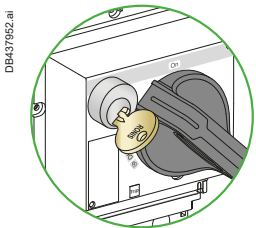

Rotary-handle locking using a keylock

Locking in the OFF position guarantees isolation as per IEC 60947-2. Padlocking systems can receive up to three padlocks with shackle diameters ranging from 5 to 8 mm (padlocks not supplied). Certain locking systems require an additional accessory.

Control device	Function	Means	Required accessories
Toggle	Lock in OFF position	Padlock	Removable device
	Lock in OFF or ON position	Padlock	Fixed device
Direct rotary handle	Standard	Lock in ■ OFF position ■ OFF or ON position [1]	Padlock - Keylock Locking device + keylock
	MCC	Lock in ■ OFF position ■ OFF or ON position [1]	Padlock -
	CNOMO	Lock in ■ OFF position ■ OFF or ON position [1]	Padlock -
Extended rotary handle	Lock in ■ OFF position ■ OFF or ON position [1] with door opening prevented [2]	Padlock	-
	Lock in OFF position	Padlock	UL508 control accessory
	■ OFF or ON position [1] inside the switchboard	Keylock	Locking device + keylock
Motor mechanism	Lock in OFF position remote operation disabled	Padlock Keylock	- Locking device + keylock
	Withdrawable circuit breaker	Lock in ■ Disconnected position	Padlock Keylock
■ Connected position		Keylock	Locking device + keylock

[1] Following a simple modification of the mechanism.

[2] Unless door locking has been voluntarily disabled.

[3] Only for 3-4P.

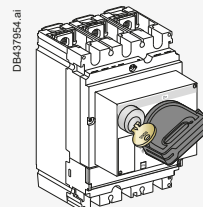
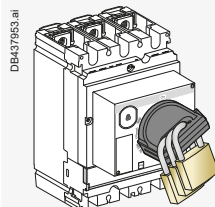

Rotary-handle locking using a padlock or a keylock

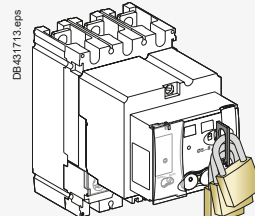
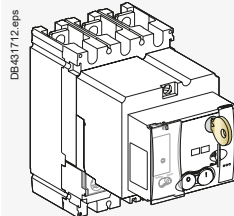

Motor mechanism locking using a padlock or a keylock

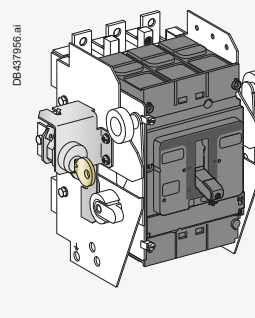
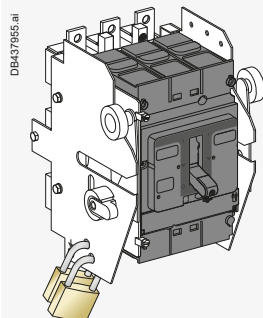

Chassis locking in the connected position

# Electrical and Mechanical Accessories

## Sealing Accessories for ComPacT NSX DC

### Outgoing-Circuit Identification

ComPacT NSX100 to 630 DC can be equipped with label holders supplied in sets of ten (cat. no. LV429226). They are compatible with escutcheons.

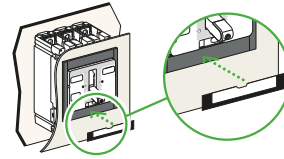

Identification accessories

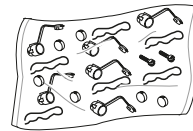

Sealing accessories

### Sealing Accessories

Sealing accessories are available. Each bag of accessories contains all the parts required for the types of sealing indicated below.

A bag contains:

- 6 sealing accessories
- 6 lead seals
- 0.5 m of wire
- 2 screws.

### Types of Seals and Corresponding Functions

<p><b>Toggle control</b></p>	<p>DB437959.ai</p>	<p>DB437959.ai</p>	<p>DB437960.ai</p>	<p>DB437963.ai</p>
<p><b>Rotary handle</b></p>	<p>DB437961.ai</p>	<p>DB437962.ai</p>	<p>DB437963.ai</p>	<p>DB437963.ai</p>
<p><b>Motor mechanism</b></p>	<p>DB431724.eps</p>	<p>DB431725.eps</p>	<p>DB431726.eps</p>	<p>DB431727.eps</p>
<p><b>Types of seals</b></p>	<p><b>Front-cover fixing screw</b></p>	<p><b>Trip unit transparent cover</b></p>	<p><b>Motor mechanism transparent cover</b></p>	<p><b>Terminal-shield fixing screw</b></p>
<p><b>Protected operations</b></p>	<ul style="list-style-type: none"> <li>■ Front removal</li> <li>■ Access to auxiliaries</li> <li>■ Trip unit removal.</li> </ul>	<ul style="list-style-type: none"> <li>■ Modification of settings</li> <li>■ Access to test connector.</li> </ul>	<ul style="list-style-type: none"> <li>■ access to manual/auto mode selection switch: depending on its position, manual [1] or automatic operation is not possible.</li> </ul> <p>[1] In this case, local operation is not possible.</p>	<ul style="list-style-type: none"> <li>■ access to power connections (protection against direct contact).</li> </ul>

DB437957.ai

DB431717.eps





# Electrical and Mechanical Accessories

## Escutcheons and Protection Collars for ComPacT NSX DC

Escutcheons are an optional feature mounted on the switchboard door. They increase the degree of protection to IP40, IK07. Protection collars maintain the degree of protection, whatever the position of the device (connected, disconnected).

A



IP30 escutcheon



IP30 escutcheon with access to the trip unit

### IP30 or IP40 Escutcheons for Fixed Devices

#### IP30

The three types are glued to the cut-out in the front door of the switchboard:

- Escutcheon for all control types (toggle, rotary handle or motor mechanism):
  - Without access to the trip unit
  - With access to the trip unit.

#### IP40

The four types, with a gasket, are screwed to the door cut-out:

- Three escutcheons identical to the previous, but IP40
- A wide model for Vigi module that can be combined with the above.

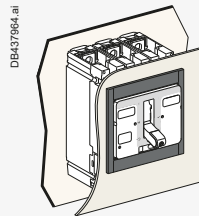

DB437964.ai

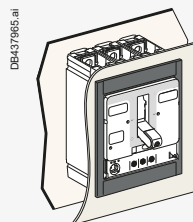

DB437965.ai

Escutcheon for toggle without and with access to the trip unit



# Electrical and Mechanical Accessories

## Escutcheons and Protection Collars for ComPacT NSX DC

### IP40 Escutcheons for Withdrawable Devices

#### IP40 for Withdrawable Devices

The two types, with a gasket, are screwed to the door cut-out:

- For rotary handle or motor mechanism: standard IP40 escutcheon
- For toggle with extension: standard escutcheon + collar for withdrawal.

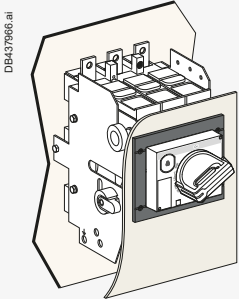

Standard escutcheon with rotary handle

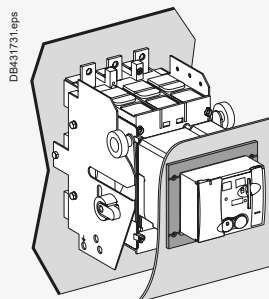

Standard escutcheon for motor mechanism

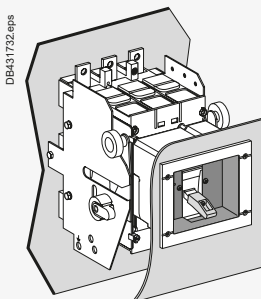

Standard escutcheon with collar for withdrawal, for toggle

### IP43 Toggle Cover

Available only for devices with toggles. Fits over toggle and front cover of the device.

- Mounted on the front of the circuit breaker.
- Degree of protection IP43, IK07.



Toggle cover

### Retrofit Front Covers

These replacement front covers make it possible to install NSX DC devices in existing switchboards containing NSX devices by installing the NSX-type retrofit covers on the NSX DC devices.

- NSX100 to 250 DC cover.
- NSX400/630 DC cover.



Escutcheon with collar for toggle



Toggle cover



NSX retrofit front cover

PB103775-36.eps

A

PB103775-40.eps

PB103820\_35.eps

# TransferPacT Source-Changeover Systems Presentation

PE191615-50.eps



A

65597-117.eps



Some installations use two supply sources to counter the temporary loss of the main supply.

A source-changeover system is required to safely switch between the two sources. The replacement source can be a generator set or another network.

## Manual Source-Changeover System or MTSE (Manual Transfer Switching Equipment)

The simplest way to switch the load. It is controlled manually by an operator. The time required to switch from the S1 source to S2 source is variable.

### System

2 or 3 mechanically interlocked circuit breakers or 2 switch-disconnectors.

### Applications

Small commercial buildings and small and medium industrial activities where the need for continuity of service is significant but not a priority.

## Automatic Source-Changeover System or ATSE (Automatic Transfer Switching Equipment)

An automatic controller may be added to a remote operated source-changeover system. It is possible to automatically control source transfer according to programmed (dedicated controllers) or programmable (PLC) operating modes. These solutions ensure optimum energy management.

The time required to switch from the S1 source to S2 source is fixed.

### System

2 or 3 circuit breakers linked by an electrical interlocking system. A mechanical interlocking system protects also against incorrect manual operations, with an automatic control system (dedicated controllers).

### Applications

Large infrastructures, industry, critical buildings & process where the continuity of service is a priority.

> TransferPacT (Source-changeover systems)



LVPED216028EN

# TransferPacT Source-Changeover Systems

## Manual Source-Changeover Systems

### Interlocking of Two or Three Toggle-Controlled Devices

#### Interlocking system

Two devices can be interlocked using this system. Two identical interlocking systems can be used to interlock three devices installed side by side.

Authorized positions:

- One device closed (ON), the others open (OFF)
- All devices open (OFF).

The system is locked using one or two padlocks (shackle diameter 5 to 8 mm).

This system can be expanded to more than three devices.

There are two interlocking-system models:

- One for ComPacT INS/INV
- One for ComPacT NSX100 to NSX250
- One for ComPacT NSX400 to NSX630.

#### Combinations of Normal and Replacement devices

All toggle-controlled fixed or plug-in ComPacT NSX100 to NSX630 circuit breakers and switch-disconnectors of the same frame size can be interlocked. The devices must be either all fixed or all plug-in versions.

### Interlocking of Two Devices with Rotary Handles

#### Interlocking system

Interlocking involves padlocking the rotary handles on two devices which may be either circuit breakers or switch-disconnectors.

Authorized positions:

- One device closed (ON), the other open (OFF)
- Both devices open (OFF).

The system is locked using up to three padlocks (shackle diameter 5 to 8 mm).

There are two interlocking-system models:

- One for ComPacT INS/INV
- One for ComPacT NSX100 to NSX250
- One for ComPacT NSX400 to NSX630.

#### Combinations of Normal and Replacement devices

All rotary-handle fixed or plug-in ComPacT NSX100 to NSX630 circuit breakers and switch-disconnectors of the same frame size can be interlocked. The devices must be either all fixed or all plug-in versions.

### Interlocking of Two Devices on a Base Plate

#### Interlocking system

A base plate designed for two ComPacT NSX devices can be installed horizontally or vertically on a mounting rail. Interlocking is carried out on the base plate by a mechanism located behind the devices. In this way, access to the device controls and trip units is not blocked.

#### Combinations of Normal and Replacement devices

All rotary-handle and toggle-controlled ComPacT NSX100 to NSX630 circuit breakers and switch-disconnectors can be interlocked. Devices must be either all fixed or all plug-in versions, with or without earth-leakage protection or measurement modules. An adaptation kit is required to interlock:

- Two plug-in devices
- A ComPacT NSX100 to NSX250 with an NSX400 to NSX630.

Connection to the downstream installation can be made easier using a coupling accessory (see next page).

### Interlocking of a Number of Devices Using Keylocks (Captive Keys)

Interlocking using keylocks is very simple and makes it possible to interlock two or more devices that are physically distant or that have very different characteristics, for example medium-voltage and low-voltage devices or a ComPacT NSX100 to NSX630 switch-disconnector.

#### Interlocking system

Each device is equipped with an identical keylock and the key is captive on the closed (ON) device. A single key is available for all devices. It is necessary to first open (OFF position) the device with the key before the key can be withdrawn and used to close another device.

A system of wall-mounted captive key boxes makes a large number of combinations possible between many devices.

#### Combinations of Normal and Replacement devices

All rotary-handle ComPacT NSX100 to NSX630 circuit breakers and switch-disconnectors can be interlocked between each other or with any other device equipped with the same type of keylock.



Interlocking of two or three toggle-controlled devices

PB113435.eps

A



Interlocking of two devices with rotary handles

PB113418.eps

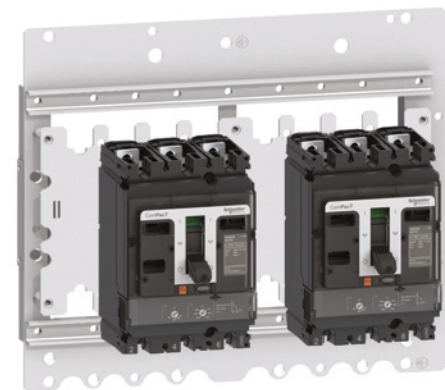

Interlocking on a base plate

PB113417.eps



Interlocking with keylocks

PB113029.eps

# Circuit Breaker Characteristics

## ComPacT NSX80 TM DC PV to NSX500 TM DC PV



ComPacT NSX200 TM DC PV

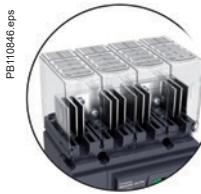

Connection and insulation accessories

### ComPacT NSX DC PV circuit breaker

Number of poles

#### Electrical Characteristics As Per IEC 60947-2 and EN 60947-2

Rated current (A) (free air + no venting)	$I_n$	40 °C heatsink standard-IP4X
Altitude	m	2000
Rated insulation voltage (V)	$U_i$	
Rated impulse withstand voltage (kV)	$U_{imp}$	
Rated operational voltage (V)	$U_e$	DC

#### Type of circuit breaker

Ultimate breaking capacity (L/R 2 ms)	$I_{cu}$ (kArms)	DC	1000 V (4P series)
Service breaking capacity	$I_{cs}$	% $I_{cu}$	
Suitability for isolation			

Selectivity category (Utilization category)  
Pollution degree

#### Durability

Endurance (C-O cycles)	Mechanical	
	Electrical ( $I_n$ )	1000 V

#### Protection

Overload/short-circuit protection Thermal magnetic

#### Installation and connections

Control	Manual	Toggle
	Motor mechanism	
Connections	Fixed	Front connection
		ILong rear connection
	Pug-in (on base)	Front connection
		Rear connection
Withdrawable (on chassis)	Front connection	
	Rear connection	

#### Additional measurement, indication and control auxiliaries

Indication contacts	OF	Auxiliary contact
	SD, SDE	Trip, fault-trip
Voltage releases	MX, MN	Shunt trip/undervoltage release

#### Installation

Accessories	Crimp lugs/bare cable connector
	Terminal extensions and spreaders
	Escutcheons
	Terminal shields and interphase barriers
	Din rail adapter

#### Dimensions and weight

Dimensions (mm) W x H x D (w/o series connection)	4P
Weight (kg)	Fixed front connection 4P

#### [1] Double earth fault:

PV systems are either insulated from the earth or one pole is earthed through an overcurrent protection. In both set-ups, therefore, there can be a ground fault in which current leaks to the ground. If this fault is not cleared, it may spread to the healthy pole and give rise to a hazardous situation where fire could break out. Even though double insulation makes such an eventuality unlikely, it deserves full attention.

For the two following reasons the double fault situation shall be absolutely avoided: insulation monitoring devices or overcurrent protection in earthed system shall detect first fault and staff shall look after the first fault and clear it with no delay.

- The fault level could be low (e.g. two insulation faults or a low short-circuit capability of the generator in weak sunlight) and below the tripping value of overcurrent protection (circuit breaker or fuses). However, a DC arc fault does not extinguish itself, even when the current is low. It could be a serious hazard, particularly for PV modules on buildings.

- Circuit breakers and switches used in PV systems are designed to break the rated current or fault current with all poles at open-circuit maximum voltage ( $U_{OC\ MAX}$ ). To break the current when  $U_{OC\ MAX}$  is equal to 1000 V, four poles in series (two poles in series for each polarity) are required. In double earth fault situations, the circuit breaker or switches must break the current at full voltage with only two poles in series. Such switchgear is not designed for that purpose and could sustain irremediable damage if used to break the current in a double ground fault situation.

The ideal solution is to prevent double ground faults arising. Insulation monitoring devices or overcurrent protection in grounded systems detect the first fault. However, although the insulation fault monitoring system usually stops the inverter, the fault is still present. Staff must locate and clear it without delay. In large generators with sub-arrays protected by circuit breakers, it is highly advisable to disconnect each array when that first fault has been detected but not cleared within the next few hours.

# Circuit Breaker Characteristics

## ComPacT NSX80 TM DC PV to NSX500 TM DC PV



	NSX80 TM DC PV	NSX125 TM DC PV	NSX160 TM DC PV	NSX200 TM DC PV	NSX250 TM DC PV	NSX320 TM DC PV	NSX400 TM DC PV	NSX500 TM DC PV
	4	4	4	4	4	4	4	4
	80	125	160	200	250	320	400	500
	☉	☉	☉	☉	☉	☉	☉	☉
	1000	1000	1000	1000	1000	1000	1000	1000
	8	8	8	8	8	8	8	8
	1000	1000	1000	1000	1000	1000	1000	1000
	10 <sup>[1]</sup>	10 <sup>[1]</sup>	10 <sup>[1]</sup>	10 <sup>[1]</sup>	10 <sup>[1]</sup>	10 <sup>[1]</sup>	10 <sup>[1]</sup>	10 <sup>[1]</sup>
	50 %	50 %	50 %	50 %	100 %	100 %	100 %	100 %
	☉	☉	☉	☉	☉	☉	☉	☉
	A	A	A	A	A	A	A	A
	3	3	3	3	3	3	3	3
	10000	10000	10000	10000	5000	5000	5000	5000
	1500	1500	1000	1000	1000	1000	1000	1000
	☉	☉	☉	☉	☉	☉	☉	☉
	☉	☉	☉	☉	☉	☉	☉	☉
	☉	☉	☉	☉	☉	☉	☉	☉
	☉	☉	☉	☉	☉	☉	☉	☉
	-	-	-	-	-	-	-	-
	-	-	-	-	-	-	-	-
	-	-	-	-	-	-	-	-
	-	-	-	-	-	-	-	-
	☉	☉	☉	☉	☉	☉	☉	☉
	☉	☉	☉	☉	☉	☉	☉	☉
	☉	☉	☉	☉	☉	☉	☉	☉
	☉	☉	☉	☉	☉	☉	☉	☉
	☉	☉	☉	☉	☉	☉	☉	☉
	☉	☉	☉	☉	☉	☉	☉	☉
	☉	☉	☉	☉	-	-	-	-
	140 x 161 x 86	140 x 161 x 86	140 x 161 x 86	140 x 161 x 86	225 x 185 x 110	225 x 185 x 110	225 x 185 x 110	225 x 185 x 110
	2.8	2.8	2.8	2.8	8.1	8.1	8.1	8.1

Trip unit for ComPacT NSX DC PV non interchangeable <sup>[2]</sup>									
Type of trip unit	TM 80 DC PV	TM 125 DC PV	TM 160 DC PV	TM 200 DC PV	TM 250 DC PV	TM 320 DC PV	TM 400 DC PV	TM 500 DC PV	
Rating	In (A) at 40 °C								
	80	125	160	200	250	320	400	500	
<b>Overload protection (thermal)</b>									
Tripping threshold	Ir (A) at 40 °C								
	Adjustable 0.7 to 1 x In								
<b>Protection against short-circuits (magnetic)</b>									
Pick-up	Ii (A)								
	Fixed 800 A	Fixed 1250 A	Adjustable 5 to 10 In						

<sup>[2]</sup> See tripping curves page E-14 and E-15.



# Circuit Breaker Characteristics

## ComPacT NSX100 TM DC EP to NSX500 TM DC EP

C25F4TM250D3-\_L50.epa



ComPacT NSX250 TM DC EP

C50F4TM500D3-\_L50.epa



ComPacT NSX500 TM DC EP

A

ComPacT NSX DC EP circuit breaker			NSX100 TM DC EP
Frame			250
Number of poles			4
<b>Electrical Characteristics As Per IEC 60947-2 and EN 60947-2</b>			
Rated current (A) (free air + no venting)	In	40 °C heatsink standard-IP4X 50 °C	100
Altitude	m	2000	⊙
Rated insulation voltage (V)	Ui		1600
Rated impulse withstand voltage (kV)	Uimp		8
Rated operational voltage (V)	Ue	DC	1500
<b>Type of circuit breaker</b>			
Ultimate breaking capacity	Icu (kA rms)	DC	1100 V (4P series) 50 [1]
Service breaking capacity	Ics	% Icu	40 %
Ultimate breaking capacity	Icu (kA rms)	DC	1500 V (4P series) 20 [1]
Service breaking capacity	Ics	% Icu	100 %
Ultimate breaking capacity (L/R 2 ms)	Icu (kA rms)	DC	1100 V (4P series) 50 [1]
Service breaking capacity	Ics	% Icu	40 %
Ultimate breaking capacity (L/R 2 ms)	Icu (kA rms)	DC	1500 V (4P series) 20 [1]
Service breaking capacity	Ics	% Icu	100 %
Suitability for isolation			⊙
Selectivity category (Utilization category)			A
Pollution degree			3
<b>Durability</b>			
Endurance (C-O cycles)	Mechanical		10000
	Electrical (In)	1500 V	4500
<b>Protection</b>			
Overload/short-circuit protection	Thermal magnetic		⊙
<b>Installation and connections</b>			
Control	Manual	toggle	⊙
	Motor mechanism		⊙
Connections	Fixed	Front connection	⊙
		Long rear connection	⊙
	Plug-in (on base)	Front connection	-
		Rear connection	-
	Withdrawable (on chassis)	Front connection	-
		Rear connection	-
<b>Additional measurement, indication and control auxiliaries</b>			
Indication contacts	OF	Auxiliary contact	⊙
	SD, SDE	Trip, fault-trip	⊙
Voltage releases	MX, MN	Shunt trip/undervoltage release	⊙
<b>Installation</b>			
Accessories	Crimp lugs/bare cable connector		⊙
	Terminal extensions and spreaders		⊙
	Escutcheons		⊙
	Terminal shields and interphase barriers		⊙
	Din rail adapter		⊙
<b>Dimensions and weight</b>			
Dimensions (mm) W x H x D (w/o series connection)		4P	140 x 161 x 86
Weight (kg)	Fixed front connection	4P	2.8

[1] Double earth fault:

PV systems are either insulated from the earth or one pole is earthed through an overcurrent protection. In both set-ups, therefore, there can be a ground fault in which current leaks to the ground. If this fault is not cleared, it may spread to the healthy pole and give rise to a hazardous situation where fire could break out. Even though double insulation makes such an eventuality unlikely, it deserves full attention.

For the two following reasons the double fault situation shall be absolutely avoided: insulation monitoring devices or overcurrent protection in earthed system shall detect first fault and staff shall look after the first fault and clear it with no delay.

■ The fault level could be low (e.g. two insulation faults or a low short-circuit capability of the generator in weak sunlight) and below the tripping value of overcurrent protection (circuit breaker or fuses). However, a DC arc fault does not extinguish itself, even when the current is low. It could be a serious hazard, particularly for PV modules on buildings.



# Circuit Breaker Characteristics

## ComPacT NSX100 TM DC EP to NSX500 TM DC EP



	NSX125 TM DC EP	NSX160 TM DC EP	NSX200 TM DC EP	NSX250 TM DC EP	NSX250 TM DC EP	NSX320 TM DC EP	NSX400 TM DC EP	NSX500 TM DC EP
	250 4	250 4	250 4	250 4	500 4	500 4	500 4	500 4
	125	160	200	250	250	320	400	500
	☉	☉	☉	☉	☉	☉	☉	☉
	1600 8	1600 8	1600 8	1600 8	1600 8	1600 8	1600 8	1600 8
	1500	1500	1500	1500	1500	1500	1500	1500
	50 <sup>[1]</sup> 40 % 20 <sup>[1]</sup> 100 % 50 <sup>[1]</sup>	50 <sup>[1]</sup> 40 % 20 <sup>[1]</sup> 100 % 50 <sup>[1]</sup>	50 <sup>[1]</sup> 40 % 20 <sup>[1]</sup> 100 % 50 <sup>[1]</sup>	50 <sup>[1]</sup> 40 % 20 <sup>[1]</sup> 100 % 50 <sup>[1]</sup>	50 <sup>[1]</sup> 100 % 50 <sup>[1]</sup> 40 % 50 <sup>[1]</sup>	50 <sup>[1]</sup> 100 % 50 <sup>[1]</sup> 40 % 50 <sup>[1]</sup>	50 <sup>[1]</sup> 100 % 50 <sup>[1]</sup> 40 % 50 <sup>[1]</sup>	50 <sup>[1]</sup> 100 % 50 <sup>[1]</sup> 40 % 50 <sup>[1]</sup>
	40 % 20 <sup>[1]</sup>	40 % 20 <sup>[1]</sup>	40 % 20 <sup>[1]</sup>	40 % 20 <sup>[1]</sup>	100 % 50 <sup>[1]</sup>	100 % 50 <sup>[1]</sup>	100 % 50 <sup>[1]</sup>	100 % 50 <sup>[1]</sup>
	100 % ☉	100 % ☉	100 % ☉	100 % ☉	100 % ☉	100 % ☉	100 % ☉	100 % ☉
	A 3	A 3	A 3	A 3	A 3	A 3	A 3	A 3
	10000 4500	10000 4500	10000 4500	10000 4500	8000 3000	8000 3000	8000 3000	8000 3000
	☉	☉	☉	☉	☉	☉	☉	☉
	☉	☉	☉	☉	☉	☉	☉	☉
	☉	☉	☉	☉	☉	☉	☉	☉
	☉	☉	☉	☉	☉	☉	☉	☉
	☉	☉	☉	☉	-	-	-	-
	-	-	-	-	-	-	-	-
	-	-	-	-	-	-	-	-
	-	-	-	-	-	-	-	-
	☉	☉	☉	☉	☉	☉	☉	☉
	☉	☉	☉	☉	☉	☉	☉	☉
	☉	☉	☉	☉	☉	☉	☉	☉
	☉	☉	☉	☉	☉	☉	☉	☉
	☉	☉	☉	☉	☉	☉	☉	☉
	☉	☉	☉	☉	-	-	-	-
	140 x 161 x 86 2.8	140 x 161 x 86 2.8	140 x 161 x 86 2.8	140 x 161 x 86 2.8	225 x 185 x 110 8.1	225 x 185 x 110 8.1	225 x 185 x 110 8.1	225 x 185 x 110 8.1

■ Circuit breakers and switches used in PV systems are designed to break the rated current or fault current with all poles at open-circuit maximum voltage ( $U_{OC\ MAX}$ ). To break the current when  $U_{OC\ MAX}$  is equal to 1000 V, four poles in series (two poles in series for each polarity) are required. In double earth fault situations, the circuit breaker or switches must break the current at full voltage with only two poles in series. Such switchgear is not designed for that purpose and could sustain irreparable damage if used to break the current in a double ground fault situation.

The ideal solution is to prevent double ground faults arising. Insulation monitoring devices or overcurrent protection in grounded systems detect the first fault. However, although the insulation fault monitoring system usually stops the inverter, the fault is still present. Staff must locate and clear it without delay. In large generators with sub-arrays protected by circuit breakers, it is highly advisable to disconnect each array when that first fault has been detected but not cleared within the next few hours.

# Switch-Disconnectors Characteristics

## ComPacT NSX100 NA DC PV to NSX500 NA DC PV

19\_C254290/DS-eps



ComPacT NSX200 NA DC PV

PB110847-eps



ComPacT NSX200 NA DC PV

A

### ComPacT NSX DC PV switch-disconnector

Number of poles

#### Electrical Characteristics As Per IEC 60947-3

Rated current (A) (free air + no venting)	$I_n$	40 °C
Altitude	m	2000
Rated insulation voltage (V)	$U_i$	
Rated impulse withstand voltage ( $U_{imp}$ ) (kV)		
Rated operational voltage (V)	$U_e$	DC

#### Type of circuit breaker

Rated short circuit withstand current (kA rms)	$I_{cw}/I_{cm}$	$t = 1 \text{ s}$
Rated conditionnal short-circuit current	$I_q$ With back-up fuse	kA A gPV
Rated conditionnal short-circuit current	$I_q$ with circuit breaker	kA with MCCB

Utilization category  
Suitability for isolation

Pollution degree

#### Durability

Endurance (C-O cycles)	Mechanical	
	Electrical ( $I_n$ )	1000 V

#### Installation and connections

Control	Manual	Toggle
		Direct or extended rotary handle
Connections	Fixed	Motor mechanism
Connections	Fixed	Front connection
		Long rear connection
	Plug-in (on base)	Front connection
		Rear connection
Withdrawable (on chassis)	Front connection	
	Rear connection	

#### Additional measurement, indication and control auxiliaries

Indication contacts	OF	Auxiliary contact
	SD, SDE	Trip, fault-trip
Voltage releases	MX, MN	Shunt trip/undervoltage release

#### Installation

Accessories	Crimp lugs/bare cable connector
	Terminal extensions and spreaders
	Escutcheons
	Terminal shields and interphase barriers
	Din rail adapter

#### Dimensions and weight

Dimensions (mm) W x H x D (w/o series connection)	4P
Weight (kg) (w/o series connection)	4P

#### [1] Double earth fault:

PV systems are either insulated from the earth or one pole is earthed through an overcurrent protection. In both set-ups, therefore, there can be a ground fault in which current leaks to the ground. If this fault is not cleared, it may spread to the healthy pole and give rise to a hazardous situation where fire could break out. Even though double insulation makes such an eventuality unlikely, it deserves full attention.

For the two following reasons the double fault situation shall be absolutely avoided: insulation monitoring devices or overcurrent protection in earthed system shall detect first fault and staff shall look after the first fault and clear it with no delay.

- The fault level could be low (e.g. two insulation faults or a low short-circuit capability of the generator in weak sunlight) and below the tripping value of overcurrent protection (circuit breaker or fuses). However, a DC arc fault does not extinguish itself, even when the current is low. It could be a serious hazard, particularly for PV modules on buildings.

- Circuit breakers and switches used in PV systems are designed to break the rated current or fault current with all poles at open-circuit maximum voltage ( $U_{OC\ MAX}$ ). To break the current when  $U_{OC\ MAX}$  is equal to 1000 V, four poles in series (two poles in series for each polarity) are required. In double earth fault situations, the circuit breaker or switches must break the current at full voltage with only two poles in series. Such switchgear is not designed for that purpose and could sustain irremediable damage if used to break the current in a double ground fault situation.

The ideal solution is to prevent double ground faults arising. Insulation monitoring devices or overcurrent protection in grounded systems detect the first fault. However, although the insulation fault monitoring system usually stops the inverter, the fault is still present. Staff must locate and clear it without delay. In large generators with sub-arrays protected by circuit breakers, it is highly advisable to disconnect each array when that first fault has been detected but not cleared within the next few hours.

# Switch-Disconnectors Characteristics

## ComPacT NSX100 NA DC PV to NSX500 NA DC PV

NSX100 NA DC PV	NSX160 NA DC PV	NSX200 NA DC PV	NSX400 NA DC PV	NSX500 NA DC PV
4	4	4	4	4
100 heatsink - IP4X ☉	160 heatsink - IP4X ☉	200 heatsink - IP4X ☉	400 heatsink - IP3X ☉	500 heatsink - IP3X ☉
1000 [1]	1000 [1]	1000 [1]	1000 [1]	1000 [1]
8	8	8	8	8
1000	1000	1000	1000	1000
2.5	2.5	2.5	6	6
10	10	10	10	10
100	160	200	400	500
10 NSX125 TM DC PV DC22-A ☉	10 NSX160-200 TM DC PV DC22-A ☉	10 NSX200 TM DC PV DC22-A ☉	- DC22-A ☉	- DC22-A ☉
3	3	3	3	3
10000	10000	10000	5000	5000
1500	1000	1000	1000	1000
☉	☉	☉	☉	☉
☉	☉	☉	☉	☉
☉	☉	☉	☉	☉
☉	☉	☉	☉	☉
☉	☉	☉	☉	☉
-	-	-	-	-
-	-	-	-	-
-	-	-	-	-
-	-	-	-	-
☉	☉	☉	☉	☉
☉	☉	☉	☉	☉
☉	☉	☉	☉	☉
■	☉	☉	☉	☉
■	☉	☉	☉	☉
■	☉	☉	☉	☉
■	☉	☉	☉	☉
■	☉	☉	-	-
140 x 161 x 86 2.8	140 x 161 x 86 2.8	140 x 161 x 86 2.8	185 x 255 x 110 8.1	185 x 255 x 110 8.1



# Switch-Disconnectors Characteristics

## ComPacT NSX630b NA DC PV to NSX1600 NA DC PV

PB112180\_53.epa



ComPacT NSX1600 NA DC PV

A

### ComPacT NSX DC PV switch-disconnector

Number of poles

#### Electrical Characteristics As Per IEC 60947-3

Rated current (A) (free air + no venting)	$I_n$	40 °C
Altitude	m	2000
Rated insulation voltage (V)	$U_i$	
Rated impulse withstand voltage (kV)	$U_{imp}$	
Rated operational voltage (V)	$U_e$	DC

#### Type of circuit breaker

Rated short circuit withstand current (kA rms)	$I_{cw}/I_{cm}$	$t = 1 \text{ s}$
Rated conditionnal short-circuit current	$I_q$	kA
	With back-up fuse	A gPV

Rated conditionnal short-circuit current  $I_q$  with circuit breaker

Utilization category

Suitability for isolation

Pollution degree

#### Durability

Endurance (C-O cycles)	Mechanical	
	Electrical ( $I_n$ )	1000 V

#### Installation and connections

Control	Manual	
	Motor mechanism	
Connections	Fixed	Front connection
		Rear connection

#### Additional measurement, indication and control auxiliaries

Indication contacts	OF	Auxiliary contact
Voltage releases	MX, MN	Shunt trip/undervoltage release

#### Installation

Accessories	Terminal extensions
	Escutcheons
	Terminal shields and interphase barriers

#### Dimensions and weight

Dimensions (mm) W x H x D (w/o series connection)	4P
Weight (kg) (w/o series connection)	4P

#### [1] Double earth fault:

PV systems are either insulated from the earth or one pole is earthed through an overcurrent protection. In both set-ups, therefore, there can be a ground fault in which current leaks to the ground. If this fault is not cleared, it may spread to the healthy pole and give rise to a hazardous situation where fire could break out. Even though double insulation makes such an eventuality unlikely, it deserves full attention.

For the two following reasons the double fault situation shall be absolutely avoided: insulation monitoring devices or overcurrent protection in earthed system shall detect first fault and staff shall look after the first fault and clear it with no delay.

- The fault level could be low (e.g. two insulation faults or a low short-circuit capability of the generator in weak sunlight) and below the tripping value of overcurrent protection (circuit breaker or fuses). However, a DC arc fault does not extinguish itself, even when the current is low. It could be a serious hazard, particularly for PV modules on buildings.

- Circuit breakers and switches used in PV systems are designed to break the rated current or fault current with all poles at open-circuit maximum voltage ( $U_{OC\text{MAX}}$ ). To break the current when  $U_{OC\text{MAX}}$  is equal to 1000 V, four poles in series (two poles in series for each polarity) are required. In double earth fault situations, the circuit breaker or switches must break the current at full voltage with only two poles in series. Such switchgear is not designed for that purpose and could sustain irremediable damage if used to break the current in a double ground fault situation.

The ideal solution is to prevent double ground faults arising. Insulation monitoring devices or overcurrent protection in grounded systems detect the first fault. However, although the insulation fault monitoring system usually stops the inverter, the fault is still present. Staff must locate and clear it without delay. In large generators with sub-arrays protected by circuit breakers, it is highly advisable to disconnect each array when that first fault has been detected but not cleared within the next few hours.

# Switch-Disconnectors Characteristics

## ComPacT NSX630b NA DC PV to NSX1600 NA DC PV

	NSX630b NA DC PV	NSX800b NA DC PV	NSX1000 NA DC PV	NSX1250 NA DC PV	NSX1600 NA DC PV
	4	4	4	4	4
630 heatsink - IP2X	800 heatsink - IP2X	1000 heatsink - IP2X	1250 heatsink - IP2X	1500 heatsink - IP0	
1000 [1]	1000 [1]	1000 [1]	1000 [1]	1000 [1]	
8	8	8	8	8	
1000	1000	1000	1000	1000	
20	20	20	20	20	
10	10	10	10	10	
N/A	N/A	N/A	N/A	N/A	
10	10	10	10	10	
DC22-A	DC22-A	DC22-A	DC22-B	DC22-B	
3	3	3	3	3	
10000	10000	10000	10000	10000	
1000	500	500	100	100	
280 x 327 x 182	280 x 327 x 182	280 x 327x 182	280 x 327 x 182	280 x 327 x 182	
18	18	18	18	18	

A

# Switch-Disconnectors Characteristics

## ComPacT NSX100 NA DC EP to NSX630 NA DC EP

A



ComPacT NSX250 NA DC EP



ComPacT NSX630 NA DC EP

### ComPacT NSX DC EP switch-disconnector

Frame

Number of poles

#### Electrical Characteristics As Per IEC 60947-3

Rated current (A) (free air + no venting)  $I_n$  40 °C

60 °C

Altitude  $m$  2000

Rated insulation voltage (V)  $U_i$

Rated impulse withstand voltage (kV)  $U_{imp}$

Rated operational voltage (V)  $U_e$  DC

#### Type of circuit breaker

Rated short circuit withstand current (kA rms)  $I_{cw}/I_{cm}$   $t = 1 s$

Utilization category

Suitability for isolation

Pollution degree

#### Durability

Endurance (C-O cycles) Mechanical  
Electrical ( $I_n$ ) 1500 V

#### Installation and connections

Control Manual Toggle  
Direct or extended rotary handle

Motor mechanism

Connections Fixed Front connection  
Long rear connection  
Plug-in (on base) Front connection  
Rear connection  
Withdrawable (on chassis) Front connection  
Rear connection

#### Additional measurement, indication and control auxiliaries

Indication contacts OF Auxiliary contact  
SD, SDE Trip, fault-trip  
Voltage releases MX, MN Shunt trip/undervoltage release

#### Installation

Accessories Crimp lugs/bare cable connector  
Terminal extensions and spreaders  
Escutcheons  
Terminal shields and interphase barriers  
Din rail adapter

#### Dimensions and weight

Dimensions (mm) W x H x D (w/o series connection) 4P  
Weight (kg) (w/o series connection) 4P

#### [1] Double earth fault:

PV systems are either insulated from the earth or one pole is earthed through an overcurrent protection. In both set-ups, therefore, there can be a ground fault in which current leaks to the ground. If this fault is not cleared, it may spread to the healthy pole and give rise to a hazardous situation where fire could break out. Even though double insulation makes such an eventuality unlikely, it deserves full attention.

For the two following reasons the double fault situation shall be absolutely avoided: insulation monitoring devices or overcurrent protection in earthed system shall detect first fault and staff shall look after the first fault and clear it with no delay.

- The fault level could be low (e.g. two insulation faults or a low short-circuit capability of the generator in weak sunlight) and below the tripping value of overcurrent protection (circuit breaker or fuses). However, a DC arc fault does not extinguish itself, even when the current is low. It could be a serious hazard, particularly for PV modules on buildings.



# Switch-Disconnectors Characteristics

## ComPacT NSX100 NA DC EP to NSX630 NA DC EP

	NSX100 NA DC EP	NSX160 NA DC EP	NSX200 NA DC EP	NSX250 NA DC EP	NSX320 NA DC EP	NSX400 NA DC EP	NSX500 NA DC EP	NSX630 NA DC EP
	250	250	250	250	630	630	630	630
	4	4	4	4	4	4	4	4
	100 heatsink - IP4X	160 heatsink - IP4X	200 heatsink - IP4X	250 heatsink - IP4X	320 heatsink - IP3X	400 heatsink - IP3X	500 heatsink - IP3X	500 heatsink - IP3X
	100 IP0	160 IP0	200 IP0	250 <sup>[2]</sup> IP0	320 IP0	400 IP0	500 IP0	630 <sup>[3]</sup> IP0
	⊙	⊙	⊙	⊙	⊙	⊙	⊙	⊙
	1600 <sup>[1]</sup>	1600 <sup>[1]</sup>	1600 <sup>[1]</sup>	1600 <sup>[1]</sup>	1600 <sup>[1]</sup>	1600 <sup>[1]</sup>	1600 <sup>[1]</sup>	1600 <sup>[1]</sup>
	8	8	8	8	8	8	8	8
	1500	1500	1500	1500	1500	1500	1500	1500
	3,5	3,5	3,5	3,5	7.56	7.56	7.56	7.56
	DC-22A DC-PV2	DC-22A DC-PV2	DC-22A DC-PV2	DC-22A DC-PV2	DC-22A DC-PV2	DC-22A DC-PV2	DC-22A DC-PV2	DC-22A DC-PV2
	⊙	⊙	⊙	⊙	⊙	⊙	⊙	⊙
	3	3	3	3	3	3	3	3
	10000	10000	10000	10000	8000	8000	8000	8000
	4500	4500	4500	4500	3000	3000	3000	3000
	⊙	⊙	⊙	⊙	⊙	⊙	⊙	⊙
	⊙	⊙	⊙	⊙	⊙	⊙	⊙	⊙
	⊙	⊙	⊙	⊙	⊙	⊙	⊙	⊙
	⊙	⊙	⊙	⊙	⊙	⊙	⊙	⊙
	⊙	⊙	⊙	⊙	-	-	-	-
	-	-	-	-	-	-	-	-
	-	-	-	-	-	-	-	-
	-	-	-	-	-	-	-	-
	-	-	-	-	-	-	-	-
	⊙	⊙	⊙	⊙	⊙	⊙	⊙	⊙
	⊙	⊙	⊙	⊙	⊙	⊙	⊙	⊙
	⊙	⊙	⊙	⊙	⊙	⊙	⊙	⊙
	⊙	⊙	⊙	⊙	⊙	⊙	⊙	⊙
	⊙	⊙	⊙	-	-	-	-	-
	140 x 161 x 86	140 x 161 x 86	140 x 161 x 86	140 x 161 x 86	185 x 255 x 110	185 x 255 x 110	185 x 255 x 110	185 x 255 x 110
	2,8	2,8	2,8	2,8	8,1	8,1	8,1	8,1

■ Circuit breakers and switches used in PV systems are designed to break the rated current or fault current with all poles at open-circuit maximum voltage ( $U_{OC\ MAX}$ ). To break the current when  $U_{OC\ MAX}$  is equal to 1000 V, four poles in series (two poles in series for each polarity) are required. In double earth fault situations, the circuit breaker or switches must break the current at full voltage with only two poles in series. Such switchgear is not designed for that purpose and could sustain irremediable damage if used to break the current in a double ground fault situation.

The ideal solution is to prevent double ground faults arising. Insulation monitoring devices or overcurrent protection in grounded systems detect the first fault. However, although the insulation fault monitoring system usually stops the inverter, the fault is still present. Staff must locate and clear it without delay. In large generators with sub-arrays protected by circuit breakers, it is highly advisable to disconnect each array when that first fault has been detected but not cleared within the next few hours.

<sup>[2]</sup>  $I_n=250A$  at 50 °C  
<sup>[3]</sup>  $I_n=630A$  at 40 °C.



# Accessories and Auxiliaries

## Overview of ComPacT NSX80 TM to NSX500 TM DC PV - Circuit Breakers

DB437967.ai

A

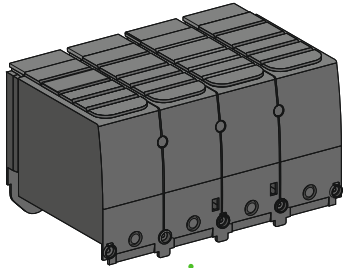

Terminal shields

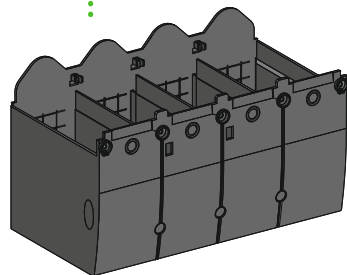
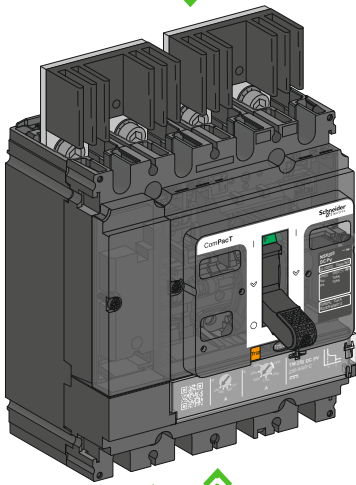

Terminal shields

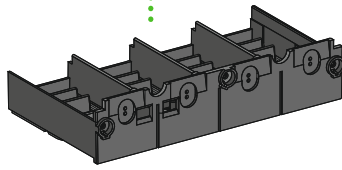

Short terminal shield

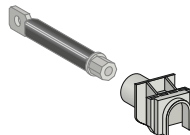

Rear connectors

### Electrical auxiliaries



Indication contact



Voltage release

### Communication [1]



NSX cord

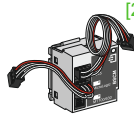

BSCM module

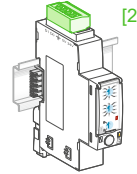

Modbus interface

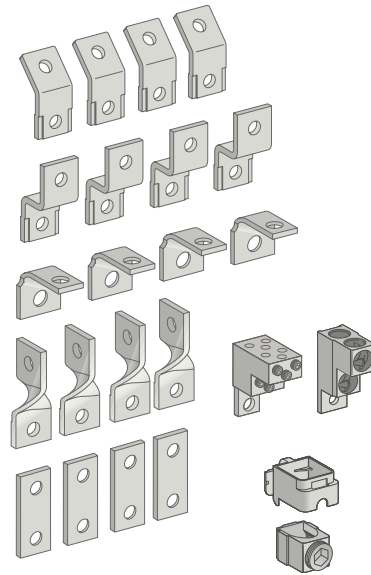

Terminal extensions

Cable connectors

[1] See communication chapter.  
 [2] ComPacT NSX100-250 only.

# Accessories and Auxiliaries

## Overview of ComPacT NSX100 NA to NSX500 NA DC PV - Switch-Disconnectors

DB437958.eps

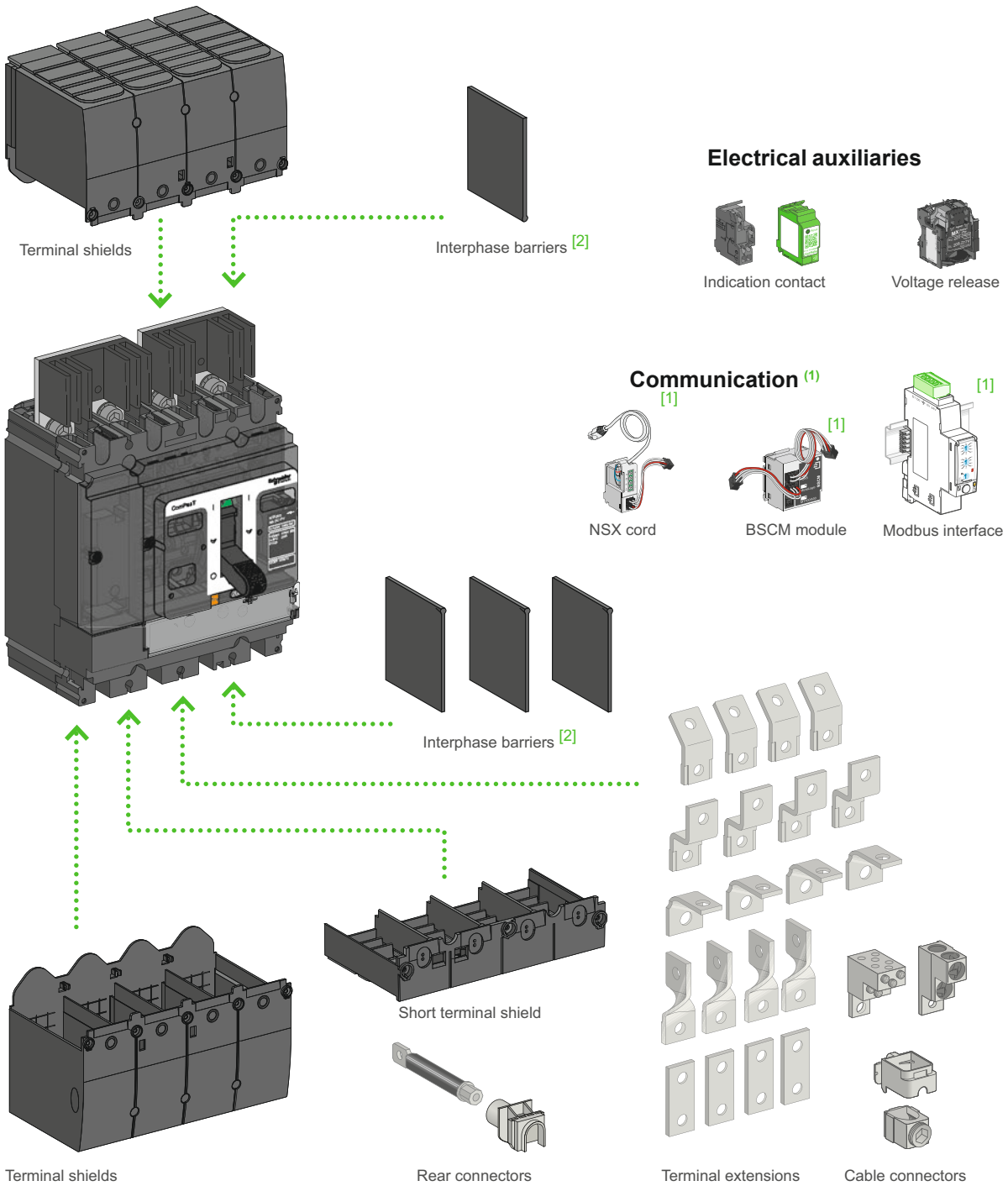

[1] See communication chapter.  
 [2] Only for switches.

# Accessories and Auxiliaries

Overview of ComPacT NSX100 TM to NSX250 TM DC EP -  
ComPacT NSX100 NA to NSX250 NA DC EP  
Circuit Breakers and Switch-Disconnectors

A

DB438100.ai

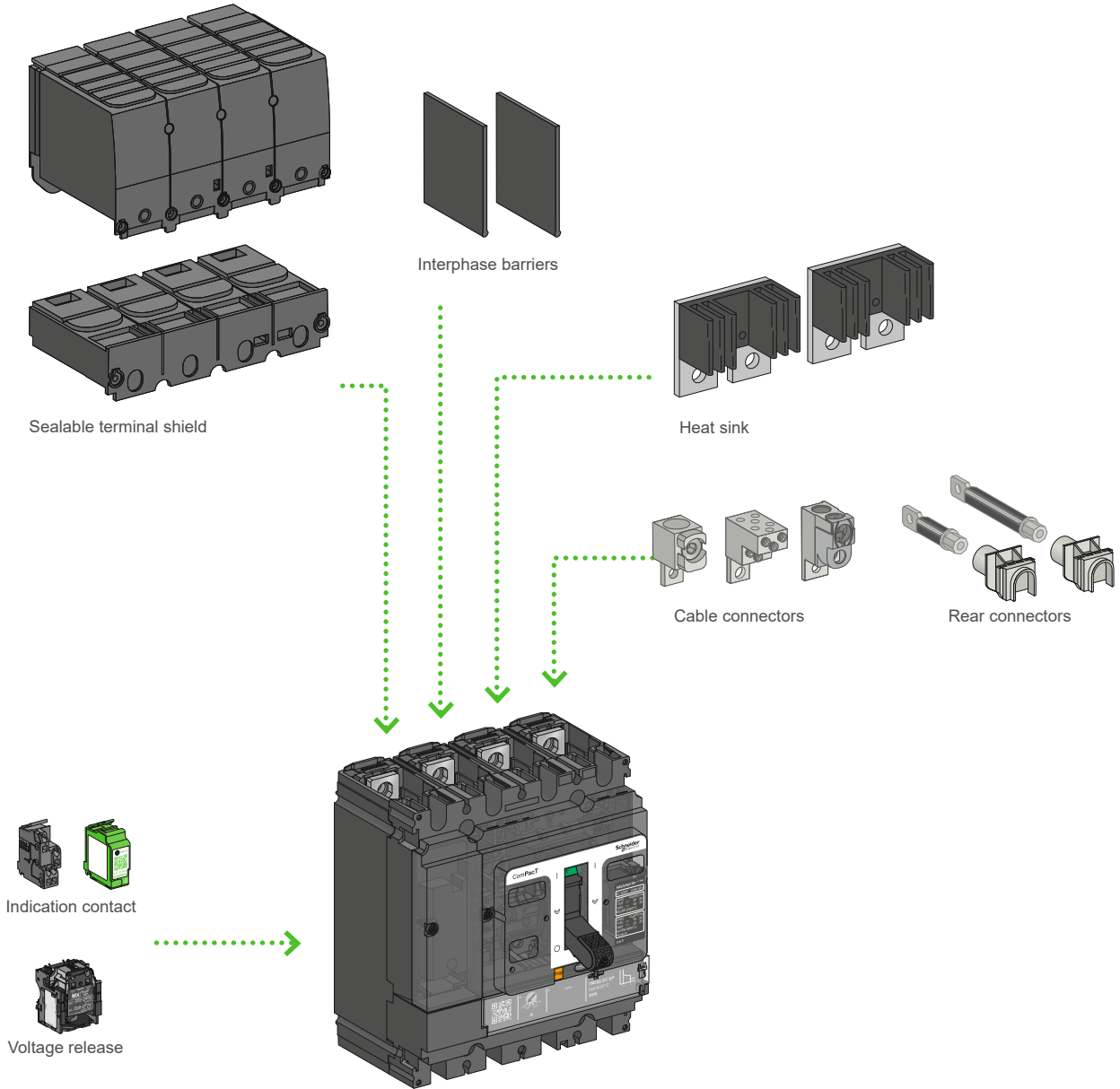

# Accessories and Auxiliaries

## Overview of ComPacT NSX250 TM to NSX500 TM DC EP - ComPacT NSX320 NA to NSX630 NA DC EP Circuit Breakers and Switch-Disconnectors

DB438121.ai

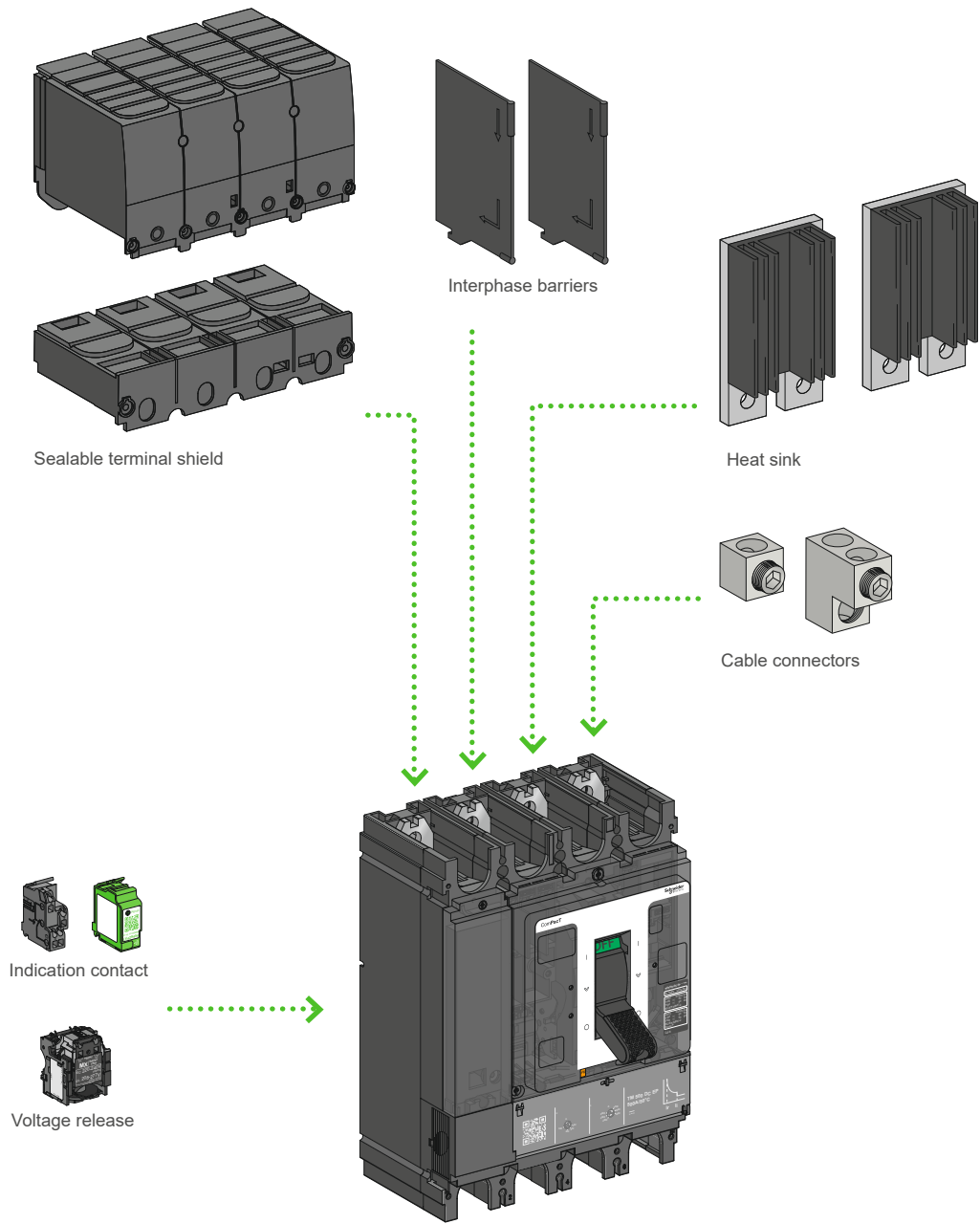

# Accessories and Auxiliaries

## Overview of ComPacT NSX630b NA to NSX1600 NA DC PV Switch-Disconnectors

DP431735.eps

A

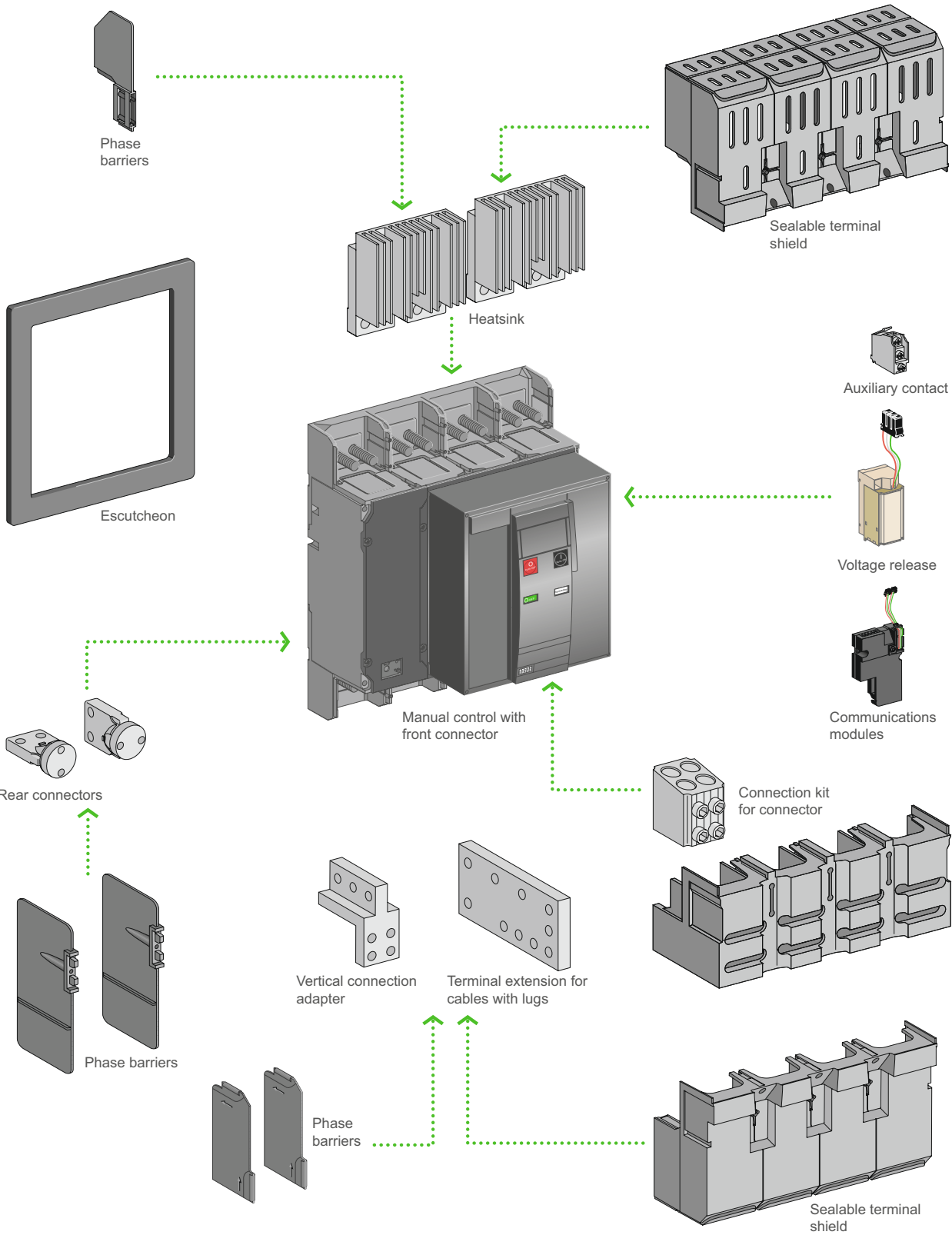



DB41787 eps

**Compact INS PV-1**

Ui	600V
Uimp	8 kV
Ith	40A 60°
--- 600V DC Max 4PS	

	Ue (V)	Ie
DC21B	600	10A
DC21B	500	25A
DC21B	400	32A
DC21B	300	40A

IEC / EN 60947-3 

**Schneider Electric**



ComPacT INS PV-1

No matter the size or scale of the project, Schneider Electric, has a photovoltaic solution to fit your needs. Fast ROI, high efficiency – it's all a part of our offer as the world leader in energy management.

The INS PV-1 is a direct current switch disconnecter dedicated to array isolation and control with Voc until 600 V DC.



ComPacT		INS80 PV
Number of poles		4 serial pole
<b>Electrical Characteristics</b>		
Conventional thermal current (A)	Ith	
Conventional thermal current in enclosure (A)	Ithe	
Rated insulation level (DC V)	Ui	
Impulse-withstand voltage (kV)	Uimp	
Rated operational voltage (DC V)	Ue	
Rated operational voltage DC21B (V)		
Rated operational current (A)	Ie	Electrical DC
	DC21B	600
	DC21B	500
	DC21B	400
Rated duties		Uninterrupted duty
		Intermittent duty
		-
		Class 120 - 60 %
Short-circuit making capacity (kA peak)	Icm	
Short-time withstand current (A rms)	Icw	
Suitability for isolation		Yes
Durability (O-C cycles)		Mechanical
		Electrical DC
		600 V
Positive contact indication		Yes
Visible break		-
Emergency-off switch disconnecter		Yes
Degree of pollution		3

## Switch-Disconnecter Selection

## ComPacT INS40 to 160 DC

PB11402\_30.eps



ComPacT INS40 to 80 switch-disconnector

PB11403\_30.eps



ComPacT INS40 to 80 emergency-off switch-disconnector

PB11406\_42.eps



ComPacT INS100 to 160 switch-disconnector

PB11407\_42.eps



ComPacT INS100 to 160 emergency-off switch-disconnector

## ComPacT INS switch-disconnectors

Number of poles

## Electrical Characteristics As Defined by IEC 60947-1/60947-3 and EN 60947-1/60947-3

Conventional thermal current (A)	<b>I<sub>th</sub></b>	at 60 °C
Conventional thermal current in enclosure	<b>I<sub>the</sub></b>	at 60 °C
Rated insulation level (V)	<b>U<sub>i</sub></b>	AC 50/60 Hz
Impulse-withstand voltage (kV)	<b>U<sub>imp</sub></b>	
Rated operational voltage (V)	<b>U<sub>e</sub></b>	AC 50/60 Hz DC
Rated operational voltage AC20 and DC20 (V)		AC 50/60 Hz
Rated operational current (A)	<b>I<sub>e</sub></b>	<b>Electrical DC</b> 125 V (2P in series) 250 V (4P in series)

Rated duties Uninterrupted duty

Intermittent duty

Short-circuit making capacity (kA peak) **I<sub>cm</sub>** Min. (switch-disconnector alone)Short-time withstand current (A rms) **I<sub>cw</sub>** 1 s  
3 s  
20 s  
30 s

Suitability for isolation

Durability (O-C cycles) Mechanical

**Electrical DC**

250 V

Positive contact indication

Visible break

Emergency-off switch disconnector

Degree of pollution

## Upstream Protection

See the "Complementary technical information" in catalog ComPacT INS/INV "LVPED213024EN".

# Functions and Characteristics

## Switch-Disconnecter Selection

### ComPacT INS40 to 160 DC



INS40		INS63		INS80		INS100		INS125		INS160	
3-4		3-4		3-4		3-4		3-4		3-4	
40		63		80		100		125		160	
40		63		80		100		125		160	
690		690		690		800		800		800	
8		8		8		8		8		8	
500		500		500		690		690		690	
250		250		250		250		250		250	
690		690		690		750		750		750	
<b>DC22A</b>	<b>DC23A</b>	<b>DC22A</b>	<b>DC23A</b>	<b>DC22A</b>	<b>DC23A</b>	<b>DC22A</b>	<b>DC23A</b>	<b>DC22A</b>	<b>DC23A</b>	<b>DC22A</b>	<b>DC23A</b>
40	40	63	63	80	80	100	100	125	125	160	160
40	40	63	63	80	80	100	100	125	125	160	160
⊙		⊙		⊙		⊙		⊙		⊙	
Class 120 - 60 %		Class 120 - 60 %		Class 120 - 60 %		Class 120 - 60 %		Class 120 - 60 %		Class 120 - 60 %	
15		15		15		20		20		20	
3000		3000		3000		5500		5500		5500	
1730		1730		1730		3175		3175		3175	
670		670		670		1230		1230		1230	
550		550		550		1000		1000		1000	
⊙		⊙		⊙		⊙		⊙		⊙	
20000		20000		20000		15000		15000		15000	
<b>DC22A</b>	<b>DC23A</b>	<b>DC22A</b>	<b>DC23A</b>	<b>DC22A</b>	<b>DC23A</b>	<b>DC22A</b>	<b>DC23A</b>	<b>DC22A</b>	<b>DC23A</b>	<b>DC22A</b>	<b>DC23A</b>
1500	1500	1500	1500	1500	1500	1500	1500	1500	1500	1500	1500
⊙		⊙		⊙		⊙		⊙		⊙	
-		-		-		-		-		-	
⊙		⊙		⊙		⊙		⊙		⊙	
3		3		3		3		3		3	
-		-		-		-		-		-	

# Switch-Disconnecter Selection

## ComPacT INS40 to 160 DC

A

### ComPacT INS switch-disconnectors

#### Installation

Fixed, front connection

Fixed, rear connection

On symmetrical rails

On a backplate

#### Connection

By cables To bare cable connectors

By cables with lugs

Directly to terminals

To spreaders

To vertical-connection adapters via cable-lug adapters

Flat-facing bars

Directly to terminals

To spreaders

Edgewise bars

To vertical-connection adapters

#### Indication and Measurement Auxiliaries

Auxiliary contacts

Current-transformer module

#### Control, Locking and Interlocking

Control

Direct front rotary handle

Extended front rotary handle

Direct lateral rotary handle

Extended lateral rotary handle

Locking

By keylock

By padlocks

Interlocking

By keylock

Mechanical

Complete source-changeover assembly

Operating torque (Nm) (typical value for 3-4 poles with front handle)

#### Installation and Connection Accessories

Bare cable connectors

Rear connectors

Terminal extensions

Spreaders

One-piece spreader

Terminal shrouds

Terminal shields

Interphase-barrier

Front panel escutcheons

Coupling accessories

Tightening torque for electrical connections (Nm)

#### Dimensions and Weights

Overall dimensions H x W x D (mm)

3 poles

4 poles

Approximate weight (kg)

3 poles

4 poles

#### Enclosure Dimensions

H x W x D (mm)

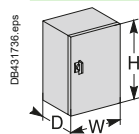

# Functions and Characteristics

## Switch-Disconnecter Selection

### ComPacT INS40 to 160 DC

A

	INS40	INS63	INS80	INS100	INS125	INS160
	⊙	⊙	⊙	⊙	⊙	⊙
	-	-	-	⊙	⊙	⊙
	⊙	⊙	⊙	-	-	-
	⊙	⊙	⊙	⊙	⊙	⊙
	⊙	⊙	⊙	⊙	⊙	⊙
	-	-	-	⊙	⊙	⊙
	-	-	-	-	-	-
	-	-	-	-	-	-
	⊙	⊙	⊙	⊙	⊙	⊙
	-	-	-	-	-	-
	-	-	-	-	-	-
	⊙	⊙	⊙	⊙	⊙	⊙
	-	-	-	-	-	-
	0.7 < Nm < 1.3	0.7 < Nm < 1.3	0.7 < Nm < 1.3	1.4 < Nm < 2	1.4 < Nm < 2	1.4 < Nm < 2
	⊙	⊙	⊙	⊙	⊙	⊙
	-	-	-	-	-	-
	⊙	⊙	⊙	⊙	⊙	⊙
	-	-	-	-	-	-
	5	5	5	8	8	8
	85 x 90 x 62.5	85 x 90 x 62.5	85 x 90 x 62.5	100 x 135 x 62.5	100 x 135 x 62.5	100 x 135 x 62.5
	85 x 90 x 62.5	85 x 90 x 62.5	85 x 90 x 62.5	100 x 135 x 62.5	100 x 135 x 62.5	100 x 135 x 62.5
	0.5	0.5	0.5	0.8	0.8	0.8
	0.6	0.6	0.6	0.9	0.9	0.9
	190 x 115 x 55	190 x 115 x 55	190 x 115 x 55	260 x 160 x 55	260 x 160 x 55	260 x 160 x 55

# Switch-Disconnecter Selection

## ComPacT INS250-100 to 630 DC

PB111440\_L32.eps



ComPacT INS250 switch-disconnector

PB111441\_L47.eps



ComPacT INS250 emergency-off switch-disconnector

PB111482\_L48.eps



ComPacT INS630 switch-disconnector

PB111483\_L48.eps



ComPacT INS630 emergency-off switch-disconnector

### ComPacT INS switch-disconnectors

Number of poles

Electrical Characteristics As Defined by IEC 60947-1/60947-3 and EN 60947-1/60947-3

Conventional thermal current (A)	<b>I<sub>th</sub></b>	at 60 °C
Conventional thermal current in enclosure	<b>I<sub>the</sub></b>	at 60 °C
Rated insulation level (V)	<b>U<sub>i</sub></b>	AC 50/60 Hz
Impulse-withstand voltage (kV)	<b>U<sub>imp</sub></b>	
Rated operational voltage (V)	<b>U<sub>e</sub></b>	AC 50/60 Hz DC
Rated operational voltage AC20 and DC20 (V)		AC 50/60 Hz
Rated operational current (A)	<b>I<sub>e</sub></b>	<b>Electrical DC</b> 125 V (2P in series) 250 V (4P in series)
Rated duties		Uninterrupted duty Intermittent duty
Short-circuit making capacity (kA peak)	<b>I<sub>cm</sub></b>	Min. (switch-disconnector alone)
Short-time withstand current (A rms)	<b>I<sub>cw</sub></b>	1 s 3 s 20 s 30 s
Suitability for isolation		
Durability (O-C cycles)		Mechanical <b>Electrical DC</b> 250 V
Positive contact indication		
Visible break		
Emergency-off switch disconnector		
Degree of pollution		

### Upstream Protection

See the "Complementary technical information" in catalog ComPacT INS/INV "LVPED213024EN".

[1] 550 A (DC).



# Functions and Characteristics

## Switch-Disconnecter Selection

### ComPacT INS250-100 to 630 DC

INS250-100		INS250-160		INS250-200		INS250		INS320		INS400		INS500		INS630	
3-4		3-4		3-4		3-4		3-4		3-4		3-4		3-4	
100	100	160	160	200	200	250	250	320	320	400	400	500	500	630	630
100	100	160	160	200	200	250	250	320	320	400	400	500	500	630 <sup>[1]</sup>	630
800	800	800	800	800	800	800	800	800	800	800	800	800	800	800	800
8	8	8	8	8	8	8	8	8	8	8	8	8	8	8	8
690	690	690	690	690	690	690	690	690	690	690	690	690	690	690	690
250	250	250	250	250	250	250	250	250	250	250	250	250	250	250	250
750	750	750	750	750	750	750	750	750	750	750	750	750	750	750	750
<b>DC22A</b>	<b>DC23A</b>	<b>DC22A</b>	<b>DC23A</b>	<b>DC22A</b>	<b>DC23A</b>	<b>DC22A</b>	<b>DC23A</b>	<b>DC22A</b>	<b>DC23A</b>	<b>DC22A</b>	<b>DC23A</b>	<b>DC22A</b>	<b>DC23A</b>	<b>DC22A</b>	<b>DC23A</b>
100	100	160	160	200	200	250	250	320	320	400	400	500	500	550	550
100	100	160	160	200	200	250	250	320	320	400	400	500	500	550	550
⊙		⊙		⊙		⊙		⊙		⊙		⊙		⊙	
Class 120 - 60 %		Class 120 - 60 %		Class 120 - 60 %		Class 120 - 60 %		Class 120 - 60 %		Class 120 - 60 %		Class 120 - 60 %		Class 120 - 60 %	
30		30		30		30		50		50		50		50	
8500		8500		8500		8500		20000		20000		20000		20000	
4900		4900		4900		4900		11500		11500		11500		11500	
2200		2200		2200		2200		4900		4900		4900		4900	
1800		1800		1800		1800		4000		4000		4000		4000	
⊙		⊙		⊙		⊙		⊙		⊙		⊙		⊙	
15000		15000		15000		15000		10000		10000		10000		10000	
<b>DC22A</b>	<b>DC23A</b>	<b>DC22A</b>	<b>DC23A</b>	<b>DC22A</b>	<b>DC23A</b>	<b>DC22A</b>	<b>DC23A</b>	<b>DC23A</b>	<b>DC23B</b>	<b>DC23A</b>	<b>DC23B</b>	<b>DC23A</b>	<b>DC23B</b>	<b>DC23A</b>	<b>DC23B</b>
1500	1500	1500	1500	1500	1500	1500	1500	1000	-	1000	-	1000	-	1000	200
⊙		⊙		⊙		⊙		⊙		⊙		⊙		⊙	
-		-		-		-		-		-		-		-	
⊙		⊙		⊙		⊙		⊙		⊙		⊙		⊙	
3		3		3		3		3		3		3		3	
-		-		-		-		-		-		-		-	



# Switch-Disconnecter Selection

## ComPacT INS250-100 to 630 DC

A

### ComPacT INS switch-disconnectors

#### Installation

Fixed, front connection

Fixed, rear connection

On symmetrical rails

On a backplate

#### Connection

By cables To bare cable connectors

By cables with lugs Directly to terminals

To spreaders

To vertical-connection adapters via cable-lug adapters

Flat-facing bars Directly to terminals

To spreaders

Edgewise bars To vertical-connection adapters

Indication and measurement auxiliaries

Auxiliary contacts

Current-transformer module

Control, locking and interlocking

Control Direct front rotary handle

Extended front rotary handle

Direct lateral rotary handle

Extended lateral rotary handle

Locking By keylock

By padlocks

Interlocking By keylock

Mechanical

Complete source-changeover assembly

Operating torque (Nm) (typical value for 3-4 poles with front handle)

#### Installation and Connection Accessories

Bare cable connectors

Rear connectors

Terminal extensions

Spreaders

One-piece spreader

Terminal shrouds

Terminal shields

Interphase-barrier

Front panel escutcheons

Coupling accessories

Tightening torque for electrical connections (Nm)

#### Dimensions and Weights

Overall dimensions H x W x D (mm) 3 poles

4 poles

Approximate weight (kg) 3 poles

4 poles

#### Enclosure Dimensions

H x W x D (mm)

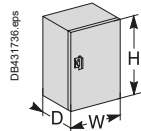



# Switch-Disconnecter Selection

## ComPacT INS630b to 2500 DC

A

PB111510\_45.eps



ComPacT INS1600 switch-disconnector

PB111511\_46.eps

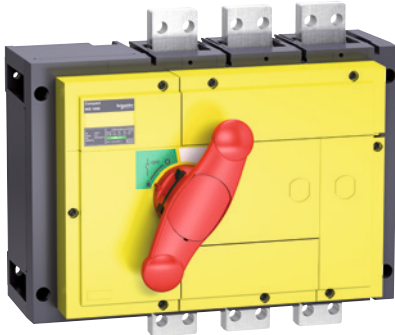

ComPacT INS1600 emergency-off switch-disconnector

PB111518\_72.eps



ComPacT INS2500 switch-disconnector

### ComPacT INS switch-disconnectors

Number of poles

#### Electrical Characteristics As Defined by IEC 60947-1/60947-3 and EN 60947-1/60947-3

Conventional thermal current (A)	<b>I<sub>th</sub></b>	at 60 °C
Conventional thermal current in enclosure	<b>I<sub>the</sub></b>	at 60 °C
Rated insulation level (V)	<b>U<sub>i</sub></b>	AC 50/60 Hz
Impulse-withstand voltage (kV)	<b>U<sub>imp</sub></b>	
Rated operational voltage (V)	<b>U<sub>e</sub></b>	AC 50/60 Hz DC
Rated operational voltage AC20 and DC20 (V)		AC 50/60 Hz
Rated operational current (A)	<b>I<sub>e</sub></b>	<b>Electrical DC</b>
		125 V (2P in series)
		250 V (4P in series)
Rated duties		Uninterrupted duty
		Intermittent duty
Short-circuit making capacity (kA peak)	<b>I<sub>cm</sub></b>	Min. (switch-disconnector alone)
Short-time withstand current (kA rms)	<b>I<sub>cw</sub></b>	0.5 s
		0.8 s
		1 s
		3 s
		20 s
		30 s

Suitability for isolation

Durability (O-C cycles)

Mechanical

**Electrical DC**

125 V (2P)  
250 V (4P)

Positive contact indication

Visible break

Emergency-off switch disconnector

Degree of pollution

#### Upstream Protection

See the "Complementary technical information" catalog ComPacT INS/INV "LVPED213024EN".

[1] For vertical connection busbars only. For horizontal connection busbars, see derating charts in "Installation recommendations" in catalog ComPacT INS/INV "LVPED213024EN".

# Functions and Characteristics

## Switch-Disconnecter Selection

### ComPacT INS630b to 2500 DC



INS630b			INS800			INS1000			INS1250			INS1600			INS2000			INS2500		
3-4			3-4			3-4			3-4			3-4			3-4			3-4		
630			800			1000			1250			1600 <sup>[1]</sup>			2000			2500		
630			800			1000			1250			1600 <sup>[1]</sup>			2000			2500		
1000			1000			1000			1000			1000			1000			1000		
12			12			12			12			12			12			12		
690			690			690			690			690			690			690		
250			250			250			250			250			250			250		
800			800			800			800			800			800			800		
<b>DC21A</b>	<b>DC22A</b>	<b>DC23A</b>	<b>DC21A</b>	<b>DC22A</b>	<b>DC23A</b>	<b>DC21A</b>	<b>DC22A</b>	<b>DC23A</b>	<b>DC21A</b>	<b>DC22A</b>	<b>DC23A</b>	<b>DC21A</b>	<b>DC22A</b>	<b>DC23A</b>	<b>DC21B</b>	<b>DC22B</b>	<b>DC23B</b>	<b>DC21B</b>	<b>DC22B</b>	<b>DC23B</b>
630/2	630/2	630/2	800/2	800/2	800/2	1000/2	1000/2	1000/2	1250/2	1250/2	1250/2	1600/2	1600/2	1600/2	2000/2	2000/2	-	2500/2	2500/2	-
630/4	630/4	630/4	800/4	800/4	800/4	1000/4	1000/4	1000/4	1250/4	1250/4	1250/4	1600/4	1600/4	1600/4	2000/4	2000/4	-	2500/4	2500/4	-
⊙			⊙			⊙			⊙			⊙			⊙			⊙		
Class 120 - 60 %			Class 120 - 60 %			Class 120 - 60 %			Class 120 - 60 %			Class 120 - 60 %			Class 120 - 60 %			Class 120 - 60 %		
75			75			75			75			75			105			105		
50			50			50			50			50			50			50		
42			42			42			42			42			50			50		
35			35			35			35			35			50			50		
20			20			20			20			20			30			30		
10			10			10			10			10			13			13		
8			8			8			8			8			11			11		
⊙			⊙			⊙			⊙			⊙			⊙			⊙		
5000			3000			3000			3000			3000			3000			3000		
<b>DC21A</b>	<b>DC22A</b>	<b>DC23A</b>	<b>DC21A</b>	<b>DC22A</b>	<b>DC23A</b>	<b>DC21A</b>	<b>DC22A</b>	<b>DC23A</b>	<b>DC21A</b>	<b>DC22A</b>	<b>DC23A</b>	<b>DC21A</b>	<b>DC22A</b>	<b>DC23B</b>	<b>DC21B</b>	<b>DC22B</b>	<b>DC23B</b>	<b>DC21B</b>	<b>DC22B</b>	<b>DC23B</b>
1000	1000	1000	500	500	500	500	500	500	500	500	500	500	500	500	100	100	-	100	100	-
1000	1000	1000	500	500	500	500	500	500	500	500	500	500	500	500	100	100	-	100	100	-
⊙			⊙			⊙			⊙			⊙			⊙			⊙		
-			-			-			-			-			-			-		
⊙			⊙			⊙			⊙			⊙			⊙			⊙		
3			3			3			3			3			3			3		
-			-			-			-			-			-			-		

# Switch-Disconnecter Selection

## ComPacT INS630b to 2500 DC

A

### ComPacT INS switch-disconnectors

#### Installation

Fixed, front connection

Fixed, rear connection

On symmetrical rails

On a backplate

#### Connection

By cables	To bare cable connectors
By cables with lugs	Directly to terminals
	To spreaders
	To vertical-connection adapters via cable-lug adapters
Flat-facing bars	Directly to terminals
	To spreaders
Edgewise bars	To vertical-connection adapters

#### Indication and Measurement Auxiliaries

Auxiliary contacts

Current-transformer module

#### Control, Locking and Interlocking

Control	Direct front rotary handle
	Extended front rotary handle
	Direct lateral rotary handle
	Extended lateral rotary handle
Locking	By keylock
	By padlocks
Interlocking	By keylock
	Mechanical

Complete source-changeover assembly

Operating torque (Nm) (typical value for 3-4 poles with front handle)

#### Installation and Connection Accessories

Bare cable connectors

Rear connectors

Terminal extensions

Spreaders

One-piece spreader

Terminal shrouds

Terminal shields

Interphase-barrier

Front panel escutcheons

Coupling accessories

Tightening torque for electrical connections (Nm)

#### Dimensions and Weights

Overall dimensions H x W x D (mm)	3 poles
	4 poles
Approximate weight (kg)	3 poles
	4 poles

#### Enclosure Dimensions

H x W x D (mm)

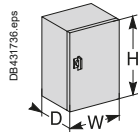



# Functions and Characteristics

## Switch-Disconnecter Selection

### ComPacT INS630b to 2500 DC

A

	INS630b	INS800	INS1000	INS1250	INS1600	INS2000	INS2500
	⊙	⊙	⊙	⊙	⊙	⊙	⊙
	⊙	⊙	⊙	⊙	⊙	⊙	⊙
	-	-	-	-	-	-	-
	⊙	⊙	⊙	⊙	⊙	⊙	⊙
	-	-	-	-	-	-	-
	-	-	-	-	-	⊙	⊙
	-	-	-	-	-	-	-
	⊙	⊙	⊙	⊙	⊙	-	-
	⊙	⊙	⊙	⊙	⊙	⊙	⊙
	⊙	⊙	⊙	⊙	⊙	-	-
	⊙	⊙	⊙	⊙	⊙	-	-
	⊙	⊙	⊙	⊙	⊙	⊙	⊙
	-	-	-	-	-	-	-
	30	30	30	30	30	60	60
	-	-	-	-	-	-	-
	-	-	-	-	-	-	-
	⊙	⊙	⊙	⊙	⊙	⊙	⊙
	⊙	⊙	⊙	⊙	⊙	⊙	⊙
	-	-	-	-	-	-	-
	-	-	-	-	-	-	-
	⊙	⊙	⊙	⊙	⊙	⊙	⊙
	⊙	⊙	⊙	⊙	⊙	⊙	⊙
	⊙	⊙	⊙	⊙	⊙	⊙	⊙
	-	-	-	-	-	-	-
	50	50	50	50	50	50	50
	300 x 340 x 146.5	300 x 340 x 146.5	300 x 340 x 146.5	300 x 340 x 146.5	300 x 340 x 146.5	440 x 347.5 x 227.5	440 x 347.5 x 227.5
	300 x 410 x 146.5	300 x 410 x 146.5	300 x 410 x 146.5	300 x 410 x 146.5	300 x 410 x 146.5	440 x 462.5 x 227.5	440 x 462.5 x 227.5
	14	14	14	14	14	35	35
	18	18	18	18	18	45	45
	-	-	-	-	-	-	-

## Switch-Disconnecter Selection

## ComPacT INV100 to 630 DC

PB111442\_02\_eps



ComPacT INV250 switch-disconnector

PB111443\_47\_eps



ComPacT INV250 emergency-off switch-disconnector

PB111464\_L49\_eps



ComPacT INV630 switch-disconnector

PB111485\_L49\_eps

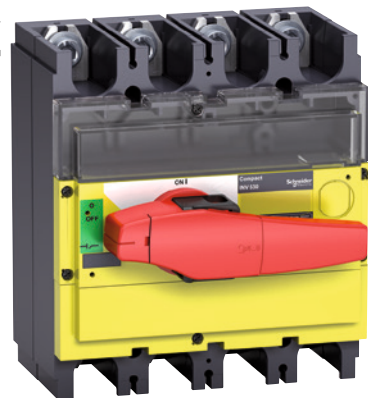

ComPacT INV630 emergency-off switch-disconnector

## ComPacT INV switch-disconnectors

Number of poles

## Electrical Characteristics As Defined by IEC 60947-1/60947-3 and EN 60947-1/60947-3

Conventional thermal current (A)	<b>I<sub>th</sub></b>	at 60 °C
Conventional thermal current in enclosure	<b>I<sub>the</sub></b>	at 60 °C
Rated insulation level (V)	<b>U<sub>i</sub></b>	AC 50/60 Hz
Impulse-withstand voltage (kV)	<b>U<sub>imp</sub></b>	
Rated operational voltage (V)	<b>U<sub>e</sub></b>	AC 50/60 Hz DC

Rated operational voltage AC20 and DC20 (V) AC 50/60 Hz

Rated operational current (A)	<b>I<sub>e</sub></b>	<b>Electrical DC</b>
		125 V (2P in series)
		250 V (4P in series)

Rated duties Uninterrupted duty

Intermittent duty

Short-circuit making capacity (kA peak) **I<sub>cm</sub>** Min. (switch-disconnector alone)Short-time withstand current (A rms) **I<sub>cw</sub>** 1 s

3 s

20 s

30 s

Suitability for isolation

Durability (O-C cycles)

Mechanical

**Electrical DC**

250 V

Positive contact indication

Visible break

Emergency-off switch disconnector

Degree of pollution

## Upstream Protection

See the "Complementary technical information" in catalog ComPacT INS/INV "LVPED213024EN".

[1] 550 A (DC).

# Functions and Characteristics

## Switch-Disconnecter Selection

### ComPacT INV100 to 630 DC



INV100			INV160			INV200			INV250			INV320			INV400			INV500			INV630			
3-4			3-4			3-4			3-4			3-4			3-4			3-4			3-4			
100	100	800	160	160	800	200	200	800	250	250	800	320	320	800	400	400	800	500	500	800	630	630 <sup>[1]</sup>	800	
8	8	690	8	8	690	8	8	690	8	8	690	8	8	690	8	8	690	8	8	690	8	8	690	
250	250	750	250	250	750	250	250	750	250	250	750	250	250	750	250	250	750	250	250	750	250	250	750	
DC21A	DC22A	DC23B	DC21A	DC22A	DC23B	DC21A	DC22A	DC23B	DC21A	DC22A	DC23B	DC21A	DC22A	DC23A	DC21A	DC22A	DC23A	DC21A	DC22A	DC23A	DC21A	DC22A	DC23A/DC23B	
100	100	100	160	160	160	200	200	200	250	250	250	320	320	320	400	400	400	500	500	500	550	550	550/630	
100	100	100	160	160	160	200	200	200	250	250	250	320	320	320	400	400	400	500	500	500	550	550	550/630	
⊙			⊙			⊙			⊙			⊙			⊙			⊙			⊙			
Class 120 - 60 %			Class 120 - 60 %			Class 120 - 60 %			Class 120 - 60 %			Class 120 - 60 %			Class 120 - 60 %			Class 120 - 60 %			Class 120 - 60 %			
30	30	8500	30	30	8500	30	30	8500	30	30	8500	50	50	20000	50	50	20000	50	50	20000	50	50	20000	
4900	4900	2200	4900	4900	2200	4900	4900	2200	4900	4900	2200	11500	11500	4900	11500	11500	4900	11500	11500	4900	11500	11500	4900	
1800	1800	15000	1800	1800	15000	1800	1800	15000	1800	1800	15000	4000	4000	10000	4000	4000	10000	4000	4000	10000	4000	4000	10000	
⊙			⊙			⊙			⊙			⊙			⊙			⊙			⊙			
DC22A	DC23A	DC22A	DC23A	DC22A	DC23A	DC22A	DC23A	DC22A	DC23A	DC21A	DC22A	DC23A	DC21A	DC22A	DC23A	DC21A	DC22A	DC23A	DC21A	DC22A	DC23A	DC21A	DC22A	DC23A/DC23B
1500	1500	1500	1500	1500	1500	1500	1500	1500	1500	1000	1000	1000	1000	1000	1000	1000	1000	1000	1000	1000	1000	1000	1000	1000/200
⊙		⊙		⊙		⊙		⊙		⊙		⊙		⊙		⊙		⊙		⊙		⊙		
⊙		⊙		⊙		⊙		⊙		⊙		⊙		⊙		⊙		⊙		⊙		⊙		
⊙		⊙		⊙		⊙		⊙		⊙		⊙		⊙		⊙		⊙		⊙		⊙		
3		3		3		3		3		3		3		3		3		3		3		3		
-		-		-		-		-		-		-		-		-		-		-		-		

# Switch-Disconnecter Selection

## ComPacT INV100 to 630 DC



### ComPacT INV switch-disconnectors

#### Installation

Fixed, front connection

Fixed, rear connection

On symmetrical rails

On a backplate

#### Connection

By cables To bare cable connectors

By cables with lugs Directly to terminals

To spreaders

To vertical-connection adapters via cable-lug adapters

Flat-facing bars Directly to terminals

To spreaders

Edgewise bars To vertical-connection adapters

#### Indication and Measurement Auxiliaries

Auxiliary contacts

Current-transformer module

#### Control, Locking and Interlocking

Control Direct front rotary handle

Extended front rotary handle

Direct lateral rotary handle

Extended lateral rotary handle

Locking By keylock

By padlocks

Interlocking By keylock

Mechanical

Complete source-changeover assembly

Operating torque (Nm) (typical value for 3-4 poles with front handle)

#### Installation and Connection Accessories

Bare cable connectors

Rear connectors

Terminal extensions

Spreaders

One-piece spreader

Terminal shrouds

Terminal shields

Interphase-barrier

Front panel escutcheons

Coupling accessories

Tightening torque for electrical connections (Nm)

#### Dimensions and Weights

Overall dimensions H x W x D (mm)

3 poles

4 poles

Approximate weight (kg)

3 poles

4 poles

#### Enclosure Dimensions

H x W x D (mm)

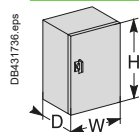

# Functions and Characteristics

## Switch-Disconnecter Selection

### ComPacT INV100 to 630 DC

A

	INV100	INV160	INV200	INV250	INV320	INV400	INV500	INV630
	⊙	⊙	⊙	⊙	⊙	⊙	⊙	⊙
	⊙	⊙	⊙	⊙	⊙	⊙	⊙	⊙
	-	-	-	-	-	-	-	-
	⊙	⊙	⊙	⊙	⊙	⊙	⊙	⊙
	⊙	⊙	⊙	⊙	⊙	⊙	⊙	⊙
	⊙	⊙	⊙	⊙	⊙	⊙	⊙	⊙
	-	-	-	-	-	-	-	-
	⊙	⊙	⊙	⊙	⊙	⊙	⊙	⊙
	⊙	⊙	⊙	⊙	⊙	⊙	⊙	⊙
	-	-	-	-	⊙	⊙	⊙	⊙
	⊙	⊙	⊙	⊙	⊙	⊙	⊙	⊙
	⊙	⊙	⊙	⊙	⊙	⊙	⊙	⊙
	⊙	⊙	⊙	⊙	⊙	⊙	⊙	⊙
	-	-	-	-	-	-	-	-
	5 < Nm < 6.2	5 < Nm < 6.2	5 < Nm < 6.2	5 < Nm < 6.2	13.5 < Nm < 16.5	13.5 < Nm < 16.5	13.5 < Nm < 16.5	13.5 < Nm < 16.5
	⊙	⊙	⊙	⊙	⊙	⊙	⊙	⊙
	⊙	⊙	⊙	⊙	⊙	⊙	⊙	⊙
	⊙	⊙	⊙	⊙	⊙	⊙	⊙	⊙
	⊙	⊙	⊙	⊙	-	-	-	-
	⊙	⊙	⊙	⊙	-	-	-	-
	⊙	⊙	⊙	⊙	⊙	⊙	⊙	⊙
	⊙	⊙	⊙	⊙	⊙	⊙	⊙	⊙
	⊙	⊙	⊙	⊙	⊙	⊙	⊙	⊙
	⊙	⊙	⊙	⊙	⊙	⊙	⊙	⊙
	-	-	-	-	-	-	-	-
	⊙	⊙	⊙	⊙	⊙	⊙	⊙	⊙
	⊙	⊙	⊙	⊙	⊙	⊙	⊙	⊙
	⊙	⊙	⊙	⊙	⊙	⊙	⊙	⊙
	⊙	⊙	⊙	⊙	⊙	⊙	⊙	⊙
	15	15	15	15	50	50	50	50
	136 x 140 x 96	136 x 140 x 96	136 x 140 x 96	136 x 140 x 96	205 x 185 x 130	205 x 185 x 130	205 x 185 x 130	205 x 185 x 130
	136 x 140 x 96	136 x 140 x 96	136 x 140 x 96	136 x 140 x 96	205 x 185 x 130	205 x 185 x 130	205 x 185 x 130	205 x 185 x 130
	2	2	2	2	4.6	4.6	4.6	4.6
	2.2	2.2	2.2	2.2	4.9	4.9	4.9	4.9
	400 x 300 x 200	400 x 300 x 200	400 x 300 x 200	400 x 300 x 200	600 x 400 x 200	600 x 400 x 200	600 x 400 x 200	600 x 400 x 200

## Functions and Characteristics

## Switch-Disconnecter Selection

## ComPacT INV630b to 2500 DC

PB11512\_45.eps



ComPacT INV1600 switch-disconnector

PB11513\_45.eps

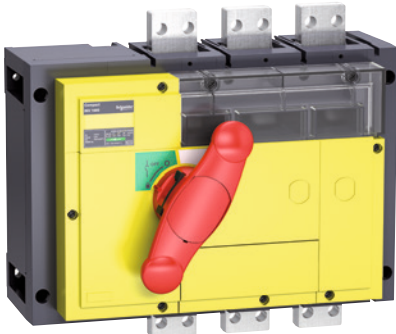

ComPacT INV1600 emergency-off switch-disconnector

PB11510\_L62.eps



ComPacT INV2500 switch-disconnector

## ComPacT INV switch-disconnectors

Number of poles

## Electrical Characteristics As Defined by IEC 60947-1/60947-3 and EN 60947-1/60947-3

Conventional thermal current (A)	<b>I<sub>th</sub></b>	at 60 °C
Conventional thermal current in enclosure	<b>I<sub>the</sub></b>	at 60 °C
Rated insulation level (V)	<b>U<sub>i</sub></b>	AC 50/60 Hz
Impulse-withstand voltage (kV)	<b>U<sub>imp</sub></b>	
Rated operational voltage (V)	<b>U<sub>e</sub></b>	AC 50/60 Hz DC
Rated operational voltage AC20 and DC20 (V)		AC 50/60 Hz
Rated operational current (A)	<b>I<sub>e</sub></b>	<b>Electrical DC</b> 125 V (2P in series) 250 V (4P in series)

Rated duties

		Uninterrupted duty
		Intermittent duty
Short-circuit making capacity (kA peak)	<b>I<sub>cm</sub></b>	Min. (switch-disconnector alone)
Short-time withstand current (kA rms)	<b>I<sub>cw</sub></b>	0.5 s 0.8 s 1 s 3 s 20 s 30 s

Suitability for isolation

Durability (O-C cycles)

Mechanical

**Electrical DC**125 V (2P)  
250 V (4P)

Positive contact indication

Visible break

Emergency-off switch disconnector

Degree of pollution

## Upstream Protection

See the "Complementary technical information" in catalog ComPacT INS/INV "LVPED213024EN".

[1] For vertical connection busbars only. For horizontal connection busbars, see derating charts in "Installation recommendations" in catalog ComPacT INS/INV "LVPED213024EN".



# Functions and Characteristics

## Switch-Disconnecter Selection

### ComPacT INV630b to 2500 DC

INV630b			INV800			INV1000			INV1250			INV1600			INV2000			INV2500		
3-4			3-4			3-4			3-4			3-4			3-4			3-4		
630			800			1000			1250			1600 <sup>[1]</sup>			2000			2500		
630			800			1000			1250			1600 <sup>[1]</sup>			2000			2500		
1000			1000			1000			1000			1000			1000			1000		
12			12			12			12			12			12			12		
690			690			690			690			690			690			690		
250			250			250			250			250			250			250		
800			800			800			800			800			800			800		
<b>DC21A</b>	<b>DC22A</b>	<b>DC23A</b>	<b>DC21A</b>	<b>DC22A</b>	<b>DC23A</b>	<b>DC21A</b>	<b>DC22A</b>	<b>DC23A</b>	<b>DC21A</b>	<b>DC22A</b>	<b>DC23A</b>	<b>DC21A</b>	<b>DC22A</b>	<b>DC23A</b>	<b>DC21B</b>	<b>DC22B</b>	<b>DC23B</b>	<b>DC21B</b>	<b>DC22B</b>	<b>DC23B</b>
630/2	630/2	630/2	800/2	800/2	800/2	1000/2	1000/2	1000/2	1250/2	1250/2	1250/2	1600/2	1600/2	1600/2	2000/2	2000/2	-	2500/2	2500/2	-
630/4	630/4	630/4	800/4	800/4	800/4	1000/4	1000/4	1000/4	1250/4	1250/4	1250/4	1600/4	1600/4	1600/4	2000/4	2000/4	-	2500/4	2500/4	-
⊙			⊙			⊙			⊙			⊙			⊙			⊙		
Class 120 - 60 %			Class 120 - 60 %			Class 120 - 60 %			Class 120 - 60 %			Class 120 - 60 %			Class 120 - 60 %			Class 120 - 60 %		
75			75			75			75			75			105			105		
50			50			50			50			50			50			50		
42			42			42			42			42			50			50		
35			35			35			35			35			50			50		
20			20			20			20			20			30			30		
10			10			10			10			10			13			13		
8			8			8			8			8			11			11		
⊙			⊙			⊙			⊙			⊙			⊙			⊙		
5000			3000			3000			3000			3000			3000			3000		
<b>DC21A</b>	<b>DC22A</b>	<b>DC23A</b>	<b>DC21A</b>	<b>DC22A</b>	<b>DC23A</b>	<b>DC21A</b>	<b>DC22A</b>	<b>DC23A</b>	<b>DC21A</b>	<b>DC22A</b>	<b>DC23A</b>	<b>DC21A</b>	<b>DC22A</b>	<b>DC23A</b>	<b>DC21B</b>	<b>DC22B</b>	<b>DC23B</b>	<b>DC21B</b>	<b>DC22B</b>	<b>DC23B</b>
1000	1000	1000	500	500	500	500	500	500	500	500	500	500	500	500	100	100	-	100	100	-
1000	1000	1000	500	500	500	500	500	500	500	500	500	500	500	500	100	100	-	100	100	-
⊙			⊙			⊙			⊙			⊙			⊙			⊙		
⊙			⊙			⊙			⊙			⊙			⊙			⊙		
⊙			⊙			⊙			⊙			⊙			-			-		
3			3			3			3			3			3			3		
-			-			-			-			-			-			-		



# Switch-Disconnecter Selection

## ComPacT INV630b to 2500 DC

A

### ComPacT INV switch-disconnectors

#### Installation

Fixed, front connection

Fixed, rear connection

On symmetrical rails

On a backplate

#### Connection

By cables	To bare cable connectors
By cables with lugs	Directly to terminals
	To spreaders
	To vertical-connection adapters via cable-lug adapters
Flat-facing bars	Directly to terminals
	To spreaders
Edgewise bars	To vertical-connection adapters

#### Indication and Measurement Auxiliaries

Auxiliary contacts

Current-transformer module

#### Control, Locking and Interlocking

Control	Direct front rotary handle
	Extended front rotary handle
	Direct lateral rotary handle
	Extended lateral rotary handle
Locking	By keylock
	By padlocks
Interlocking	By keylock
	Mechanical

Complete source-changeover assembly

Operating torque (Nm) (typical value for 3-4 poles with front handle)

#### Installation and Connection Accessories

Bare cable connectors

Rear connectors

Terminal extensions

Spreaders

One-piece spreader

Terminal shrouds

Terminal shields

Interphase-barrier

Front panel escutcheons

Coupling accessories

Tightening torque for electrical connections (Nm)

#### Dimensions and Weights

Overall dimensions H x W x D (mm)	3 poles
	4 poles
Approximate weight (kg)	3 poles
	4 poles

#### Enclosure Dimensions

H x W x D (mm)

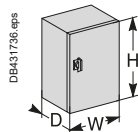

# Functions and Characteristics

## Switch-Disconnecter Selection

### ComPacT INV630b to 2500 DC

	INV630b	INV800	INV1000	INV1250	INV1600	INV2000	INV2500
	⊙	⊙	⊙	⊙	⊙	⊙	⊙
	⊙	⊙	⊙	⊙	⊙	⊙	⊙
	-	-	-	-	-	-	-
	⊙	⊙	⊙	⊙	⊙	⊙	⊙
	-	-	-	-	-	⊙	⊙
	-	-	-	-	-	-	-
	⊙	⊙	⊙	⊙	⊙	-	-
	⊙	⊙	⊙	⊙	⊙	⊙	⊙
	⊙	⊙	⊙	⊙	⊙	-	-
	⊙	⊙	⊙	⊙	⊙	-	-
	⊙	⊙	⊙	⊙	⊙	⊙	⊙
	-	-	-	-	-	-	-
	⊙	⊙	⊙	⊙	⊙	⊙	⊙
	-	-	-	-	-	-	-
	⊙	⊙	⊙	⊙	⊙	⊙	⊙
	⊙	⊙	⊙	⊙	⊙	⊙	⊙
	⊙	⊙	⊙	⊙	⊙	⊙	⊙
	-	-	-	-	-	-	-
	-	-	-	-	-	-	-
	30	30	30	30	30	60	60
	-	-	-	-	-	-	-
	-	-	-	-	-	-	-
	⊙	⊙	⊙	⊙	⊙	⊙	⊙
	⊙	⊙	⊙	⊙	⊙	⊙	⊙
	-	-	-	-	-	-	-
	-	-	-	-	-	-	-
	⊙	⊙	⊙	⊙	⊙	⊙	⊙
	⊙	⊙	⊙	⊙	⊙	⊙	⊙
	⊙	⊙	⊙	⊙	⊙	⊙	⊙
	-	-	-	-	-	-	-
	50	50	50	50	50	50	50
	300 x 340 x 146.5	300 x 340 x 146.5	300 x 340 x 146.5	300 x 340 x 146.5	300 x 340 x 146.5	440 x 347.5 x 227.5	440 x 347.5 x 227.5
	300 x 410 x 146.5	300 x 410 x 146.5	300 x 410 x 146.5	300 x 410 x 146.5	300 x 410 x 146.5	440 x 462.5 x 227.5	440 x 462.5 x 227.5
	14	14	14	14	14	35	35
	18	18	18	18	18	45	45
	-	-	-	-	-	-	-

A

# Communication

## Enerlin'X Digital System - Overview

Enerlin'X communication system provides access to status, electrical values and devices control using Ethernet and Modbus SL communication protocols.





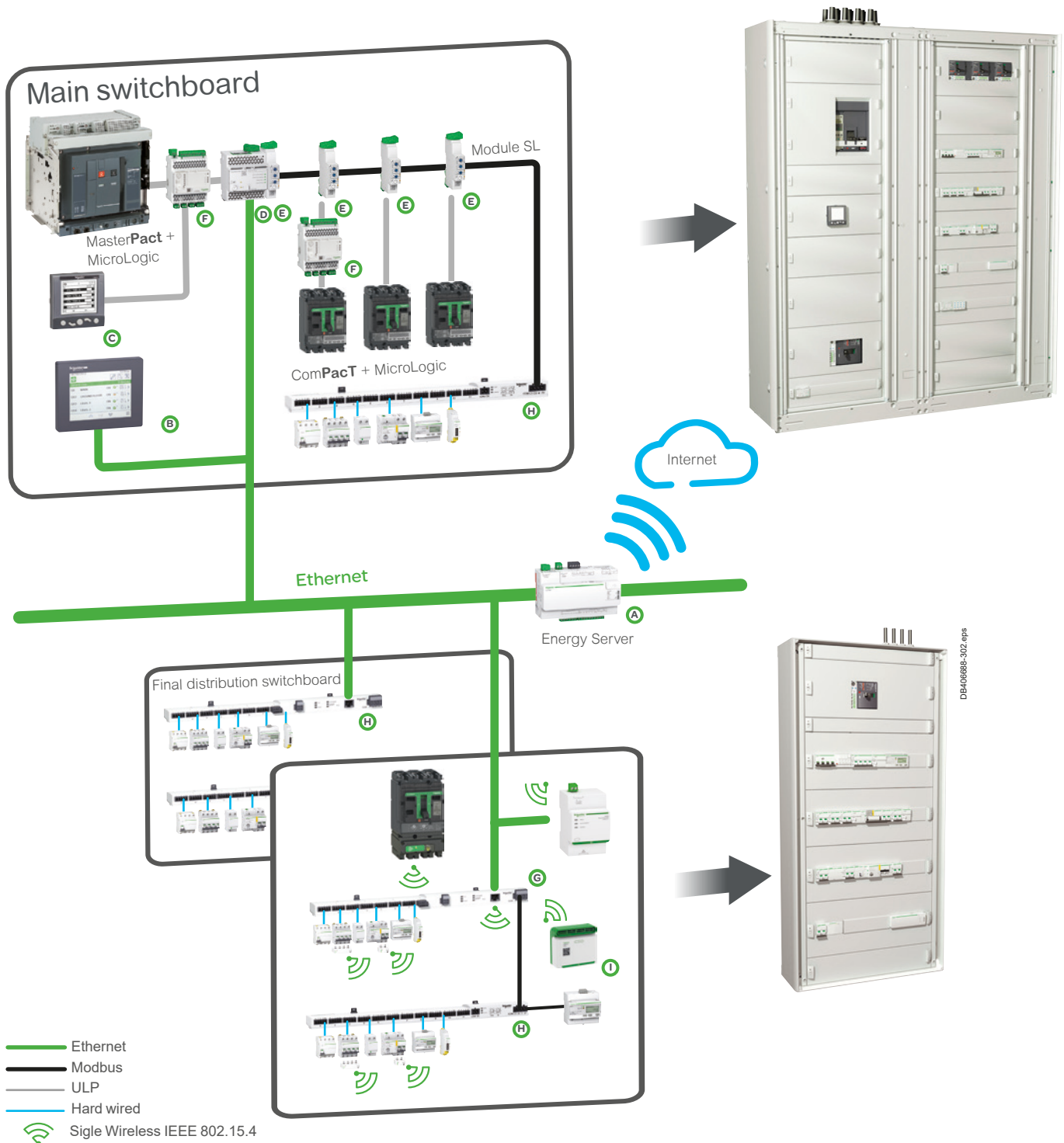



**Ethernet** has become the universal link between switchboards, computers and communication devices inside the building. The large amount of information which can be transferred makes the connection of Enerlin'X digital system to hosted web services of Schneider Electric a reality. More advantages are offered to integrators thanks to configuration web pages available remotely or on the local Ethernet network.

**Modbus SL** is the most widely used communication protocol in industrial networks. It operates in master-slave mode. The devices (slaves) communicate one after the other with a gateway (master).



# Communication

## Enerlin'X Digital System - Overview

Enerlin'X digital devices and displays							
	Name	Function	Port (to device)	Port (to server)	Inputs	Outputs	Cial. Ref.
A	 Com'X 210	Energy data logger + Ethernet Gateway	Ethernet Modbus Smartlink SI B, Zigbee (to wireless meters)	Ethernet cable + WiFi	64 devices: 6 binary 2 analog 32 Modbus devices + other Ethernet devices (Modbus TCP)	-	EBX210
	Com'X 510 24 V DC + PoE	Energy server + Ethernet Gateway				-	EBX510
B	 FDM128	Ethernet LCD color touch screen	-	Ethernet		-	LV434128
C	 FDM121	LCD display for circuit breaker	ULP	-	1 circuit breaker	-	TRV00121
D	 IFE Switchboard server	Switchboard server	Modbus Smartlink SI B & ULP	Ethernet	20 circuit breakers	-	LV434002
	IFE interface	Ethernet interface for circuit breakers	ULP	Ethernet	1 circuit breaker	-	LV434001
E	 IFM	Modbus interface for circuit breaker	ULP	Modbus Smartlink SI B	1 circuit breaker	-	LV434000
F	 I/O	Input/Output application module for circuit breaker	ULP	ULP	6 binary 1 analog (PT100 sensor)	3	LV434063
G	 Smartlink SI B Ethernet wireless	Ethernet server for I/O and Modbus Smartlink SI B devices	Modbus Smartlink SI B & Wireless to PowerTag	Ethernet	14 binary 2 analog	7	A9XMZA08
H	 Smartlink Modbus Smartlink SI B	Modbus interface with Input/Output functions	-	Modbus Smartlink SI B	22 binary	11	A9XMSB11
I	 HeatTag	Detection of overheating cables	-	-	-	-	SMT10020

> EcoStruxure Power Connected Products Catalog



LVCATENLX\_EN

**Ethernet Gateway or Interface:** routes an internal traffic (ULP or other protocols) to the Internet, the outgoing messages are coded with Modbus TCP/IP protocol.

**Server (Switchboard, Energy):** routes the internal traffic to the Internet. Other complementary functions such as data logging and storage. Provides devices status and energy trends on internal web pages...

**PowerLogic™ HeatTag:** HeatTag is a smart sensor for early detection of overheating wire connections or overheating cables. HeatTag helps prevent electrical switchboards from being damaged, by analyzing gas and particles in the air and sending alerts before any smoke or insulator browning.

**Note:** For more information, see [Configuration & commissioning guide of connected devices & software - New buildings](#)

# Communication

## IFE Ethernet Interface



IFE interface, ref.: LV434001



IFE interface + gateway, ref.: LV434002

### IFE Interface, IFE Interface + Gateway Description

#### Introduction

The IFE interface and the IFE switchboard server enable LV circuit breakers to be connected to an Ethernet network. The IFE switchboard server incorporates a Modbus gateway. The IFE interface and IFE switchboard server are both equipped with two ULP ports and two Ethernet ports. The IFE switchboard server is equipped with a Modbus RS 485 serial connection. The following circuit breakers can be connected to IFE interface and to IFE switchboard server: Fixed type MasterPact NT/NW, ComPacT NSX or PowerPacT.

#### IFE Interface: Ref. LV434001

Provides an Ethernet access to a single LV circuit breaker. The circuit breaker is connected to the IFE interface via its ULP port and a prefabricated ULP cord.

#### IFE Switchboard Server, Ref.: LV434002

Provides an Ethernet access to one or several LV circuit breakers. It allows to interface to Ethernet:

- One single circuit breaker connected to the IFE interface via its ULP port and a prefabricated ULP cord,
- Up to 12 ComPacT NSX connected through the Modbus serial line interface.

Each ComPacT NSX is connected to Modbus by means of a dedicated IFM interface module performing the ULP/Modbus conversion.

The connection between each ComPacT NSX and its associated IFM interface is realized by a prefabricated ULP cord connected to ULP ports.

#### IFE Interface, IFE Switchboard Server

Provides an Ethernet access to one or several LV circuit breakers.

#### Functions

- Interface - one circuit breaker is connected to the IFE interface via its ULP port.
- Gateway: several circuit breakers on a Modbus network are connected via the IFE interface + gateway master Modbus port.

#### IFE Interface, IFE Interface + Gateway Features

- Dual 10/100 Mbps Ethernet port for simple daisy chain connection
- Device profile web service for discovery of the IFE interface, IFE interface + gateway on the LAN
- ULP compliant for localization of the IFE interface in the switchboard
- Ethernet interface for ComPacT, MasterPact and PowerPacT circuit breakers
- Gateway for Modbus-SL connected devices (IFE interface + gateway only)
- Embedded set-up web pages
- Embedded monitoring web pages
- Embedded control web pages
- Built-in e-mail alarm notification
- RBAC (Role Base Access Control) for the embedded control web pages
- RSTP (Rapid Scanning Tree Protocol) is a solution to implement redundant Ethernet networks
- Internal real-time clock with battery back-up
- RBAC (Role Base Access Control) for the embedded control web pages
- RSTP (Rapid Scanning Tree Protocol) is a solution to implement redundant Ethernet networks
- Ethernet networks

#### Mounting

The IFE interface and the IFE switchboard server are DIN rail mounting devices. A stacking accessory enables the user to connect several IFMs (ULP to Modbus serial line interfaces) to an IFE switchboard server without additional wiring.

#### 24 V DC Power Supply

The IFE interface and the IFE switchboard server must be supplied either with a 24 V DC AD or with a 24 V DC ABL8 RPS power supply. The IFMs stacked to an IFE switchboard server are supplied by the IFE, thus it is not necessary to supply them separately.

**Note:** The connection of the +/- of the power supply on +/- terminals of the IFE device must be strictly respected. Crossing the polarities may damage the device.

#### IFE Interface, IFE Switchboard Server Firmware Update

The firmware can be updated using the EcoStruxure Power Commission software.

#### Required Circuit Breaker Communication Modules

The connection to IFE interface or to IFE switchboard server requires ULP communication ports.

- MasterPact NT/NW (Fixed or drawout): BCM ULP communication module.
- Drawout MasterPact NT/NW: BCM ULP and its respective I/O (Input/Output) application module.

All connection configurations for MasterPact NT/NW require the breaker ULP cord. The insulated NSX cord is mandatory for system voltages greater than 480 V AC. When the second ULP RJ45 connector is not used, it must be closed with an ULP terminator (TRV00880).

Characteristic		Value
Type of interface module		Modbus RTU, RS485 serial connection Modbus TCP/IP Ethernet
Transmission	Modbus RS485	Transfer rate: 9,600...19,200 Baud Medium Double shielded twisted pair Impedance 120 Ω
	Ethernet	Transfer rate: 10/100 Mbps Medium STP, Cat5e, straight cable
Structure	Type	Modbus, Ethernet
	Method	Master/Slave
Device type	Modbus	Master
	Ethernet	Server
Turnaround time	Modbus	10 ms
	Ethernet	1 ms
Maximum length of cable	Modbus	1000 m
	Ethernet	100 m
Type of bus connector	Modbus	4-pin connector
	Ethernet	RJ45 (Shielded)



# Functions and Characteristics

## Communication

### IFE Ethernet Interface

General characteristics	
Environmental characteristics	
Conforming to standards	IEC 60950, IEC 60947-6-2, UL 508, UL 60950, IACS E10
Certification	c UL us, CE, EAC, FCC marking
Ambient temperature	storage: -40 to +85 °C operation: -25 to +70 °C
Relative humidity	5 - 85 %
Level of pollution	Level 3
Protective treatment	ULV0 conforming to IEC/EN 60068-2-30
Mechanical characteristics	
Shock resistance	Conforming to IEC/EN 60068-2-27 15 g/11 ms, 1/2 sinusoidal
Resistance to sinusoidal vibrations	Conforming to IEC/EN 60068-2-6 5 Hz < f < 8.4 Hz
Electrical characteristics	
Consumption	150 mA at 24 V DC
Resistance to electrostatic discharge	IEC/EN 61000-4-2: ■ 8 kV air discharge ■ 6 kV contact discharge
Immunity to radiated fields	IEC/EN 61000-4-3: 10 V/m
Immunity to fast transient perturbations	IEC/EN 61000-4-4: 2 kV
Immunity to surges	IEC/EN 61000-4-5: 2 kV common mode
Immunity to conducted radio frequency field	IEC/EN 61000-4-6: 10 V
Physical characteristics	
Dimensions	72 x 105 x 71 mm
Mounting	DIN rail
Weight	182.5 g (0.41 lb)
Degree of protection of the installed I/O	■ On the front panel (wall mounted enclosure): IP4x ■ Connectors: IP2x ■ Other parts: IP3x
Connections	Screw type terminal blocks

### IFE Web Page Description

**Monitoring web page:**

- Real time data
- Device logging.

**Control web page:**

- Single device control.

**Diagnostics web page:**

- Statistics
- Device information
- IMU information
- Read device registers
- Communication check.

**Maintenance web page:**

- Circuit breaker health status
- Maintenance log
- Maintenance counters.

**Setup web page:**

- Device localization/name
- Ethernet configuration (dual port)
- IP configuration
- Modbus TCP/IP filtering
- Date and time
- E-mail server configuration
- Alarms to be e-mailed
- Device logging
- Device log export
- SNMP parameters
- Preferences
- Advanced services control
- User accounts
- Web page access.

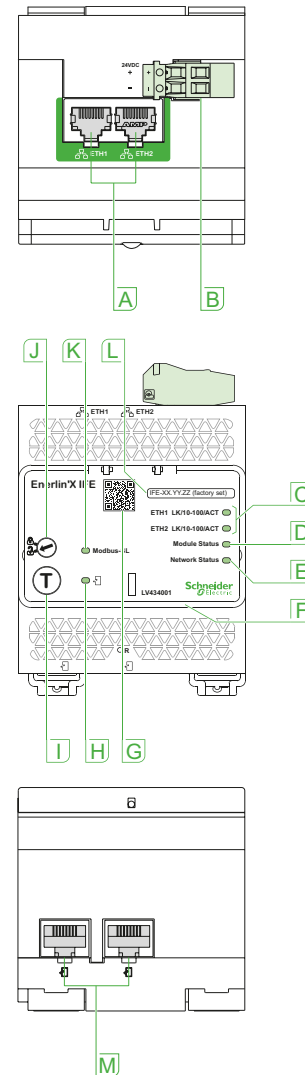

- A** Ethernet 1 and Ethernet 2 communication port
- B** 24 V DC power supply terminal block
- C** Ethernet communication LEDs:  
yellow: 10 Mb  
green: 100 Mb
- D** Module status LED:  
steady off: no power  
steady green: device operational  
steady red: major fault  
flashing green: standby  
flashing red: minor fault  
flashing green/red: self-test
- E** Network status LED:  
steady off: no power/no valid IP address  
steady green: connected, valid IP address  
steady orange: default IP address  
steady red: duplicated IP address  
flashing green/red: self-test
- F** Sealable transparent cover
- G** QR code to product information
- H** ULP status LED
- I** Test button (accessible with cover closed)
- J** Locking pad
- K** Modbus traffic status LED (LV434002 only)
- L** Device name label
- M** ULP ports

DB418230.eps

DB425732.eps

DB425733.eps



# Communication

## IFM Modbus Communication Interface



IFM Modbus communication interface  
Ref.: LV434000

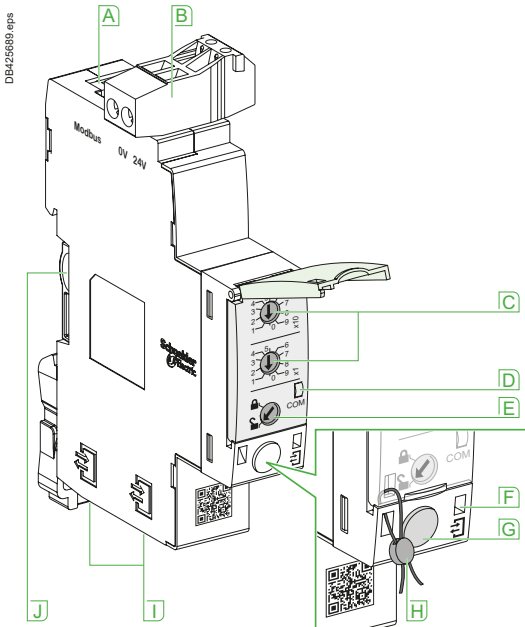

- A** Modbus screw clamp connector
- B** Modbus address switches
- C** Modbus traffic LED
- D** Modbus locking pad
- E** ULP activity LED
- F** Test button
- G** Mechanical lock
- H** ULP RJ45 connectors
- I** Stacking accessory connection

### Simplified IFM Installation

#### Stacking IFM

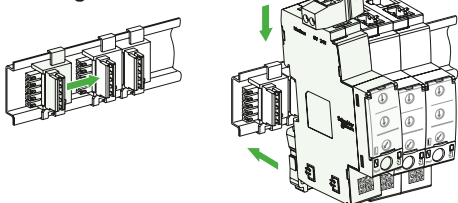

Stacking accessories      Up to 12 stacked IFM

### Function

IFM - Modbus communication interface - is required for connecting MasterPact MTZ, NT/ NW or ComPact NS and NSX to Modbus network whenever the circuit breaker has an ULP port (Universal Logic Plug). The port is available on BCM ULP for MasterPact range and BSCM module for ComPact range.

**Note:** IFM is defined as an IMU (Intelligent Modular Unit) within the ULP connection System documentation.

Once connected to IFM, the circuit breaker is considered as a slave by the Modbus master. Its electrical values, alarm status, open/close signals can be monitored or controlled by a Programmable Logic Controller or any other system.

### Characteristics

#### ULP port

- 2 RJ45 sockets, internal parallel wiring.
- Connection of a single circuit breaker.
- An ULP line terminator must be connected to the second RJ45 ULP socket. The RJ45 sockets deliver a 24 V DC supply fed from the Modbus socket.
- Built-in test function, for checking the correct connection to the circuit breaker.

#### Modbus slave port

- Modbus Serial RJ45 port - RJ45 connector provides fast and reliable wiring.
- Lateral socket, for DIN rail stackable connector.
- Both top and lateral sockets are internally parallel wired.
- Multiple IFM can be stacked, thus sharing a common power supply and Modbus line without individual wiring.
- On the front face:
  - Modbus address setting (1 to 99): 2 coded rotary switches
  - Modbus locking pad: enables or disable the circuit breaker remote control and modification of IFM parameters.
  - Self adjusting communication format (Baud rate, parity).

#### 24 V DC power supply

- Screw clamp terminal block
- High electrical insulation between Modbus and 24 V DC connectors
- Separated lines provides improved communication robustness.

### Technical Characteristics

General characteristics	
<b>Environmental Characteristics</b>	
Conforming to standards	IEC 61010, IEC 60950, UL 61010, UL 60950, CISPR 22, 24, 11, IACS E10
Certification	c UL us, CE, EAC, FCC marking
Ambient temperature	-20 to +70 °C
Relative humidity	5 - 85 %
Level of pollution	Level 3
Protective treatment	ULV0 conforming to IEC/EN 60068-2-30
<b>Mechanical characteristics</b>	
Shock resistance	Conforming to IEC/EN 60068-2-27 15 g/11 ms, 1/2 sinusoidal
Resistance to sinusoidal vibrations	Conforming to IEC/EN 60068-2-6 5 Hz < f < 8.4 Hz
<b>Electrical characteristics</b>	
Consumption	30 mA at 24 V DC
Resistance to electrostatic discharge	IEC/EN 61000-4-2: 8 kV AD
Immunity to radiated fields	IEC/EN 61000-4-3: 10 V/m
Immunity to surges	IEC/EN 61000-4-5: class 2
<b>Physical characteristics</b>	
Dimensions	109 x 73 x 18 mm
Mounting	DIN rail
Weight	120 g
Degree of protection of the installed module	<ul style="list-style-type: none"> <li>■ IP20 for connectors</li> <li>■ IP30 for other areas</li> </ul>
Connections	<ul style="list-style-type: none"> <li>■ RJ45 for ULP and Modbus SL</li> <li>■ Screw type terminals for Power</li> </ul>

#### Stacking an IFE interface + gateway with IFM

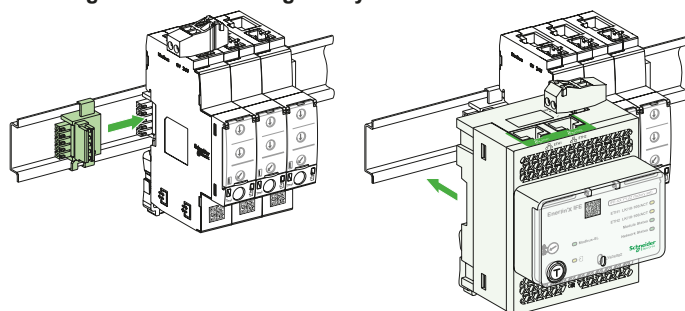

# Functions and Characteristics

## Communication

### COM Option in ComPacT and MasterPact

All the MasterPact devices can be fitted with the communication function thanks to the COM option. MasterPact uses the Ethernet or Modbus communications protocol for full compatibility with the supervision management systems. Eco COM is limited to the transmission of metering data. It is not used to communicate status and controls.

#### For fixed and Drawout devices, the common communication option is made up of:

- A BCM ULP module, installed behind the MicroLogic control unit and supplied with its set of sensors (OF, SDE, PF and CH micro switches) its kit for connection to XF and MX1 communicating voltage releases and its COM terminal block (inputs E1 to E6). This module is independent of the control unit. It receives and transmits information on the communication network. An infra-red link transmits data between the control unit and the communication module.  
Consumption: 30 mA, 24 V.
- IFM, this module required for connection to the network, contains the Modbus address (1 to 99) declared by the user via the two dials in front. It automatically adapts (baud rate, parity) to the Modbus network in which it is installed.

#### Or

- IFE, the Ethernet interface for LV circuit breaker enables an intelligent modular unit (IMU), for example a MasterPact NT/NW or ComPacT NSX circuit breaker to be connected to an Ethernet network. Each circuit breaker has its own IFE and a corresponding IP address.

#### For drawout device the Cradle Management option must be added:

I/O (Input/Output) application module for LV breaker, the I/O application module is delivered with withdrawable devices ordered with the COM option, for cradle management. It must be installed on a DIN rail near the device. It must be connected to the ULP system and to the position contacts (CD, CT, CE) that transmit the position of the device in the cradle.

#### For communicating remote control, option with XF and MX1 communicating voltage releases must be added:

The XF and MX1 communicating voltage releases are equipped for connection to the "device" communication module.

The remote-tripping function (MX2 or MN) are independent of the communication option. They are not equipped for connection to the "device" communication module.

## BSCM Module

### Functions

The optional BSCM Breaker Status & Control Module is used to acquire device status indications and control the communicating remote-control function. It includes a memory used to manage the maintenance indicators.

### Status indications

Indication of device status:  
O/F, SD and SDE.

### Maintenance indicators

The BSCM module manages the following indicators:

- Mechanical operation counter
- Electrical operation counter
- History of status indications.

It is possible to assign an alarm to the operation counters.

### Controls

The module can be used to carry out communicating remote control operations: (open, close and reset) in different modes (manual, auto).

### Mounting

The BSCM module can be installed on all ComPacT NSX circuit breakers and switch-disconnectors. It simply clips into the auxiliary contact slots. It occupies the slots of one O/F contact and one SDE contact. The BSCM is supplied with 24 V DC power automatically via the NSX cord when the communication system is installed.



BCM ULP

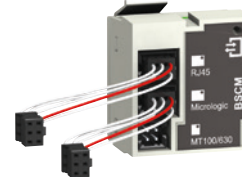

BSCM module

A

PB106874-20.eps

PB103786.eps

# Communication

## I/O Application Module



I/O application module

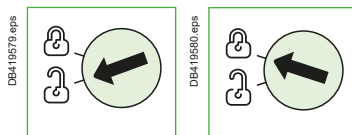
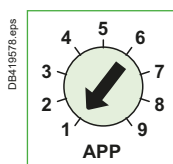

### I/O Application Module Description

#### Description

The I/O input/output application module for LV breaker is one of the components of ULP architecture. Built in functionalities and applications enhance control and monitoring needs.

ULP system architecture including I/O modules can be built without any restrictions using a wide range of circuit breakers:

- MasterPact MTZ1/MTZ2/MTZ3/NT/NW
- ComPacT NS1600b-3200
- ComPacT NS630b-1600
- ComPacT NSX100-630 A.

The I/O application module is compliant with the ULP system specifications. Two I/O application modules can be connected in the same ULP architecture.

#### I/O input/output interface for LV breaker resources

The I/O application module resources are the following:

- 6 digital inputs that are self powered for either NO and NC dry contact or pulse counter
- 3 digital outputs that are bistable relay (5 A maximum)
- 1 analog input for Pt100 temperature sensor.

#### Pre-defined applications

Pre-defined applications improve the IMU approach (Intelligent Modular Unit) in a simple way.

A 9-position rotary switch on the front of the I/O module allows to select the pre-defined applications. Each position is assigned to a pre-defined application except position 9 which allows the user to define a specific application by means of the customer engineering tool. The switch is set in factory to the pre-defined application 1.

For each application the input/output assignment and the wiring diagram are pre-defined. No additional setting with the customer engineering tool is required. The I/O and other resources not assigned to the pre-defined applications are free for user specific applications.

#### User applications

The user applications with the corresponding resources are defined by means of EcoStruxure Power Commission engineering tool. They use the resources not assigned to the predefined applications. User applications may be required for:

- Protection improvement
- Circuit breaker control
- Motor control
- Energy management
- Monitoring.

#### 24 V DC power supply

The I/O module must be supplied either with a 24 V DC AD or with a 24 V DC ABL8 RPS power supply.

**Note:** The connection of the +/- of the power supply on +/- terminals of the I/O module must be strictly respected. Crossing the polarities may damage the device.

#### Mounting

The I/O is a DIN rail mounting device.

### Setting Locking Pad

The setting locking pad on the front panel of the I/O enables the setting of the I/O by EcoStruxure Power Commission engineering tool.

# Functions and Characteristics

## Communication I/O Application Module

DE418233.eps



DB432536.eps

DE418235.eps

General characteristics		
Environmental characteristics		
Conforming to standards		IEC 60950, IEC 60947-6-2, UL 508, UL 60950, IACS E10
Certification		c UL us, CE, EAC, FCC marking
Ambient temperature	storage	-40 to +85 °C
	operation	-25 to +70 °C
Relative humidity		5 - 85 %
Level of pollution		Level 3
Protective treatment		ULV0 conforming to IEC/EN 60068-2-30
Mechanical characteristics		
Shock resistance		Conforming to IEC/EN 60068-2-27 15 g/11 ms, 1/2 sinusoidal
Resistance to sinusoidal vibrations		Conforming to IEC/EN 60068-2-6 5 Hz < f < 8.4 Hz
Electrical characteristics		
Consumption		165 mA at 24 V DC
Resistance to electrostatic discharge		IEC/EN 61000-4-2: ■ 8 kV air discharge ■ 6 kV contact discharge
Immunity to radiated fields		IEC/EN 61000-4-3: 10 V/m
Immunity to fast transient perturbations		IEC/EN 61000-4-4: 2 kV
Immunity to surges		IEC/EN 61000-4-5: 2 kV common mode
Immunity to conducted radio frequency field		IEC/EN 61000-4-6: 10 V
Physical characteristics		
Dimensions		71.7 x 116 x 70.6 mm
Mounting		DIN rail
Weight		229.5 g (0.51 lb)
Degree of protection of the installed I/O application module		On the front panel (wall mounted enclosure): IP4x I/O parts: IP3x Connectors: IP2x
Connections		Screw type terminal blocks

Digital inputs	
Digital input type	Self powered digital input with current limitations as per IEC 61131-2 type 2 standards (7 mA)
Input limit values at state 1 (close)	19.8 - 25.2 V DC, 6.1 - 8.8 mA
Input limit values at state 0 (open)	0 - 19.8 V DC, 0 mA
Maximum cable length	10 m

**Note:** For a length greater than 10 m and up to 300 m, it is mandatory to use a shielded twisted cable. The shield cable is connected to the I/O functional ground of the I/O application module.

Digital outputs	
Digital output type	Bistable relay
Rated voltage	250 V AC maximum [1]/30 V DC
Rated carry current	5 A
Contact resistance	30 mΩ
Maximum operating frequency	18000 operations/hr (Mechanical) 1800 operations/hr (Electrical)
Digital output relay protection by an external fuse	External fuse of 5 A or less
Maximum cable length	10 m

Analog inputs		
I/O application module analog input can be connected to a Pt100 temperature sensor.		
Range	-30 to 200 °C	-22 to 392 °F
Accuracy	±2 °C from -30 to 20 °C	±3.6 °F from -22 to 68 °F
	±1 °C from 20 to 140 °C	±1.8 °F from 68 to 284 °F
	±2 °C from 140 to 200 °C	±3.6 °F from 284 to 392 °F
Refresh interval	5 s	5 s

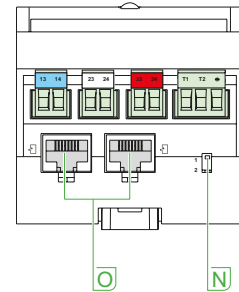
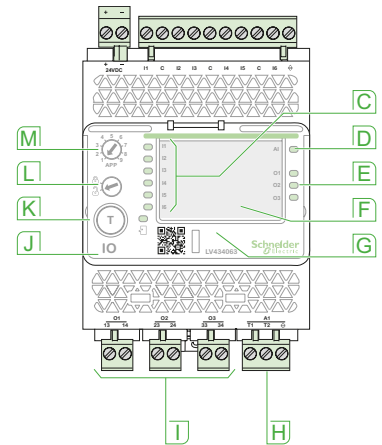
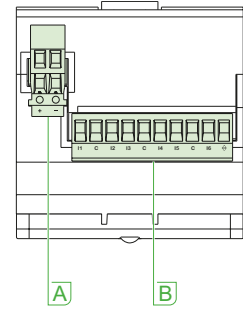

- A** 24 V DC power supply terminal block
- B** Digital input terminal block: 6 inputs, 3 commons and 1 shield
- C** 6 input status LEDs
- D** Analog input status LED
- E** 3 output status LEDs
- F** I/O application module identification labels
- G** Sealable transparent cover
- H** Analog input terminal block
- I** Digital output terminal blocks
- J** ULP status LED
- K** Test/reset button (accessible with cover closed)
- L** Setting locking pad
- M** Application rotary switch: 1 to 9
- N** Switch for I/O addressing (I/O 1 or I/O 2)
- O** ULP connectors

**[1]** 250 V AC OVC 2 according IEC/EN 60947-2. For OVC 3 and 4 surge arresters are required on the polarizing voltage of the output contacts.

# Communication

## Communications Modules, IFM and IFE for ComPacT NSX

All ComPacT NSX devices can be equipped with the communication function via a prewired connection system and a Modbus or Ethernet network interface.

The interface can be connected directly or via the FDM121 switchboard display unit. Four functional levels can be combined to adapt to all supervision requirements.

A

### Four Functional Levels

The ComPacT NSX can be integrated in a Modbus or Ethernet communication environment. Four functional levels can be used separately or combined.

#### Communication of status indications

This level is compatible with all ComPacT NSX circuit breakers, whatever the trip unit, and with all switch-disconnectors. Using the BSCM module, the following information is accessible:

- ON/OFF position (O/F)
- Trip indication (SD)
- Fault-trip indication (SDE).

#### Communication of commands

Also available on all circuit breakers and switch-disconnectors, this level (communicating remote control) can be used to:

- Open
- Close
- Reset.

#### Modbus principle

The Modbus RS 485 (RTU protocol) system is an open bus on which communicating Modbus devices (ComPacT NS with Modbus COM, Power Meter PM700, PM800, Sepam, Vigilohm, ComPacT NSX, etc.) are installed. All types of PLCs and microcomputers may be connected to the bus.

#### Addresses

The Modbus communication parameters (address, baud rate, parity) are entered using the Electrical Asset Manager or RSU (Remote Setting Utility).

#### Number of devices

The maximum number of devices that may be connected to the Modbus bus depends on the type of device (ComPacT with Modbus COM, PM700, PM800, Sepam, Vigilohm, ComPacT NSX, etc.), the baud rate (19200 is recommended), the volume of data exchanged and the desired response time. The RS 485 physical layer offers up to 32 connection points on the bus (1 master, 31 slaves).

A fixed device requires only one connection point (communication module on the device). A drawout device uses two connection points (communication modules on the device and on the chassis).

The number must never exceed 31 fixed devices or 15 drawout devices.

#### Length of bus

The maximum recommended length for the Modbus bus is 1200 meters.

#### Bus power source

A 24 V DC power supply is required (less than 20 % ripple, insulation class II).

### Ethernet Principle

Ethernet is a data link and physical layer protocol defined by IEEE 802.10 and 100 Mbps specifications that connects computer or other Ethernet devices. Ethernet is an asynchronous Carrier Sense Multiple Access with Collision detection (referred as CSMA/CD) protocol. Carrier Sense means that the hosts can detect whether the medium (coaxial cable) is idle or busy. Multiple Access means that multiple hosts can be connected to the common medium. Collision Detection means a host detects whether its transmission has collided with the transmission of another host (or hosts). IFE Ethernet interface can be connected to a PC or a laptop over Ethernet. The maximum length of Ethernet cable is 100 meters. IFE Ethernet interface + gateway provides a Modbus TCP/IP gateway over Ethernet to enable Modbus TCP communication from a Modbus TCP master to any Modbus slave devices connected to it. The maximum active Modbus TCP client connection is twelve.

IFE Ethernet interface has an embedded web server (web page).

The Modbus RS 485 (RTU protocol) system is an open bus on which communicating Modbus devices (ComPacT NS with Modbus COM, Power Meter PM700, PM800, Sepam, Vigilohm, ComPacT NSX, etc.) are installed. All types of PLCs and microcomputers may be connected to the bus.



# Communication

## Communication Components and Connections

### Connections

- ComPacT NSX is connected to the I/O application module or FDM121 display unit via the internal terminal block for the NSX cord equipped with an RJ45 connector:
- Cord available in three lengths: 0.35 m, 1.3 m and 3 m
- Insulated 1.3 m version for installations > 480 V AC
- Lengths up to 10 m possible using extensions.
- The FDM121 display unit and the I/O application module are connected to:
- The IFM Modbus interface by a communication cable with RJ45 connectors on both ends
- or
- The IFE Ethernet interface module by a communication cable with RJ45 connectors on both ends.

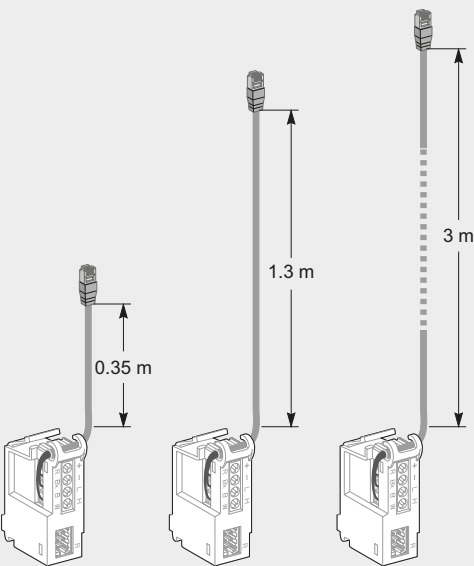

### Communication Components and Connections, IFM

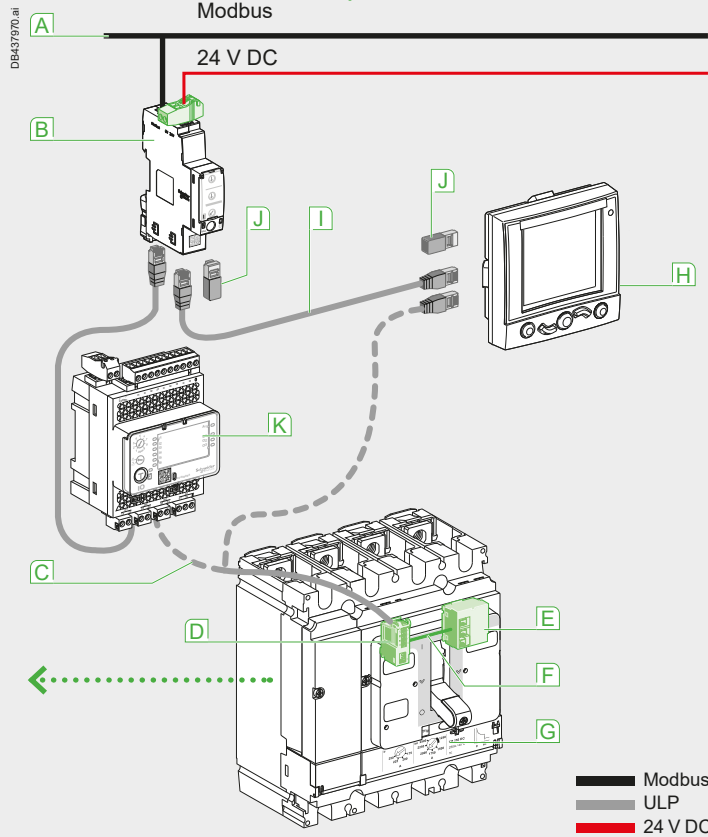

### Communication Components and Connections, IFE

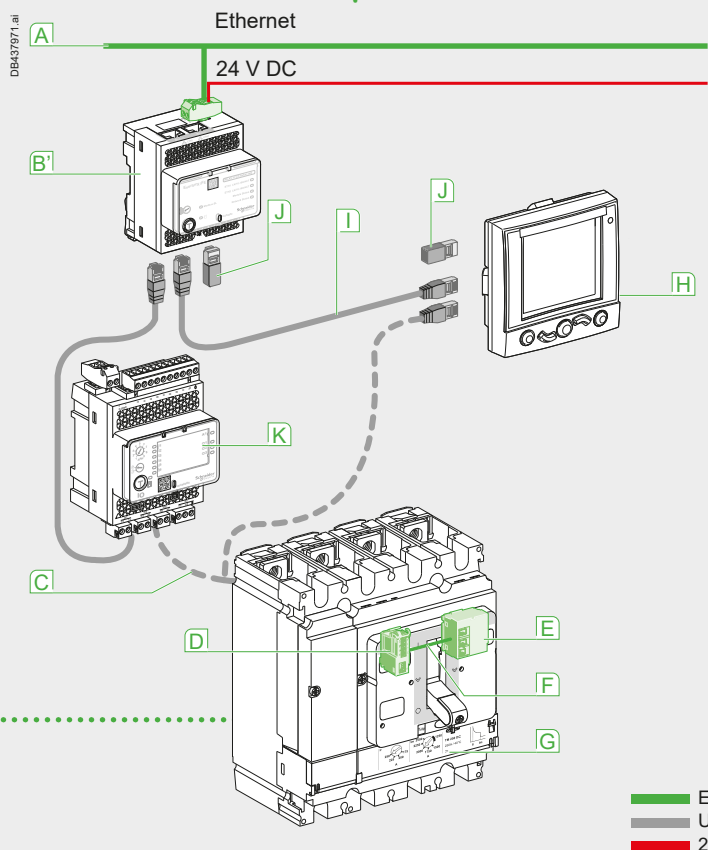

- A Modbus network
- B IFM Modbus interface
- B' IFE Ethernet interface module
- C NSX cord
- D Internal terminal block for communication via NSX cord
- E BSCM module
- F Prefabricated wiring
- G TMD trip unit
- H FDM121 display
- I RJ45 cable
- J Line terminator (on unused connector if applicable)
- K I/O application module



# Communication

## Connection of the IFE to a Fixed or Drawout MasterPact NW

Connect the IFE to a fixed electrically operated MasterPact NW or circuit breaker using the breaker ULP cord

Connect the IFE to a drawout MasterPact NW or circuit breaker using the breaker ULP cord

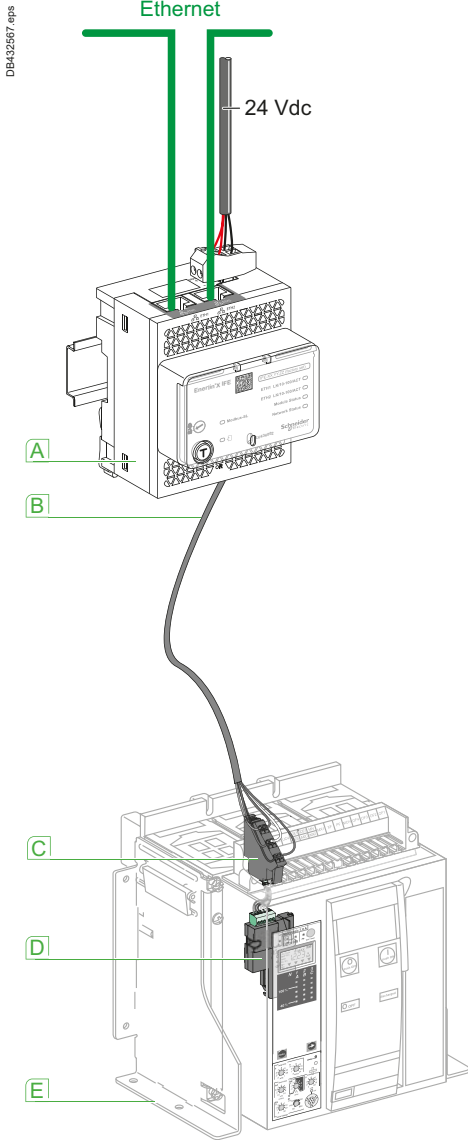

- A** IFE Ethernet interface for LV circuit breaker
- B** Breaker ULP cord
- C** Fixed COM terminal block
- D** BCM ULP communication module
- E** Fixed electrically operated circuit breaker

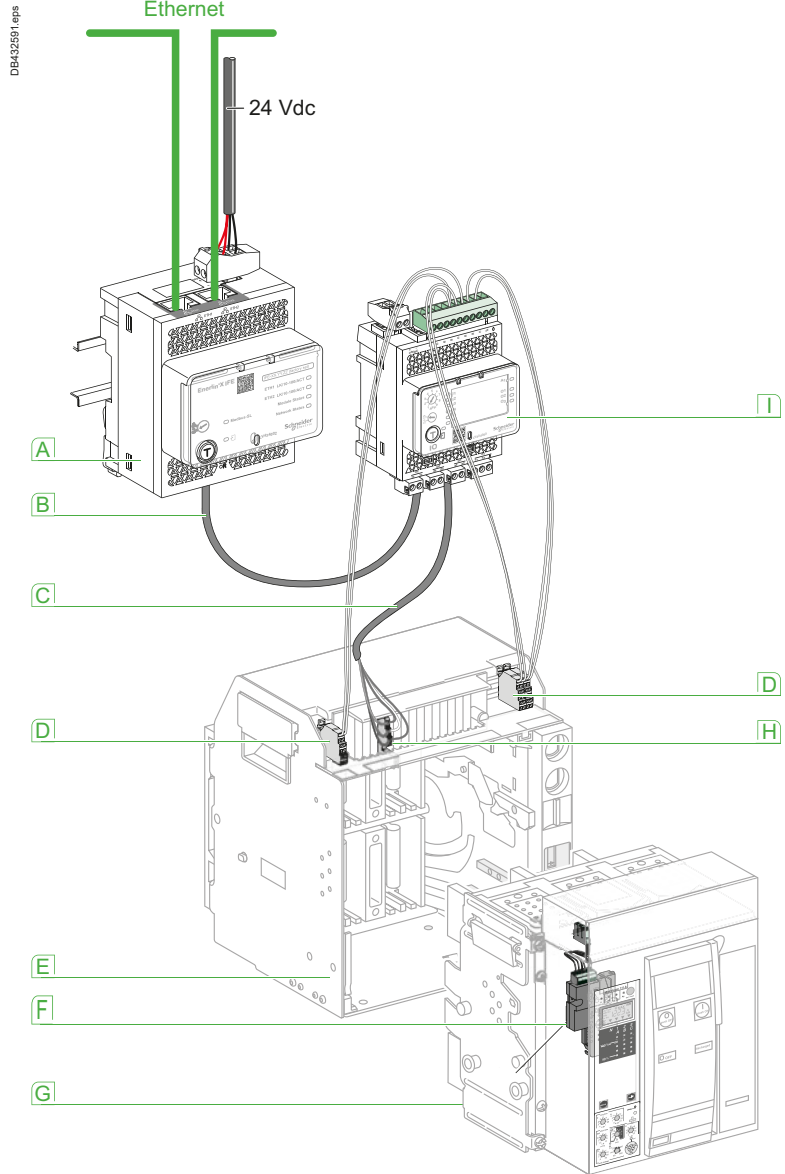

- A** IFE Ethernet interface for LV circuit breaker
- B** ULP cable
- C** Breaker ULP cord
- D** Drawout device position contacts
- E** Circuit breaker cradle
- F** BCM ULP communication module
- G** Drawout circuit breaker
- H** Drawout COM terminal block
- I** I/O (Input/Output) application module for LV circuit breaker

Connection of the IFM to a Fixed or Drawout MasterPact NW

Connect the IFM to a fixed electrically operated MasterPact NW or circuit breaker using the breaker ULP cord

Connect the IFM to a drawout MasterPact NW or circuit breaker using the breaker ULP cord

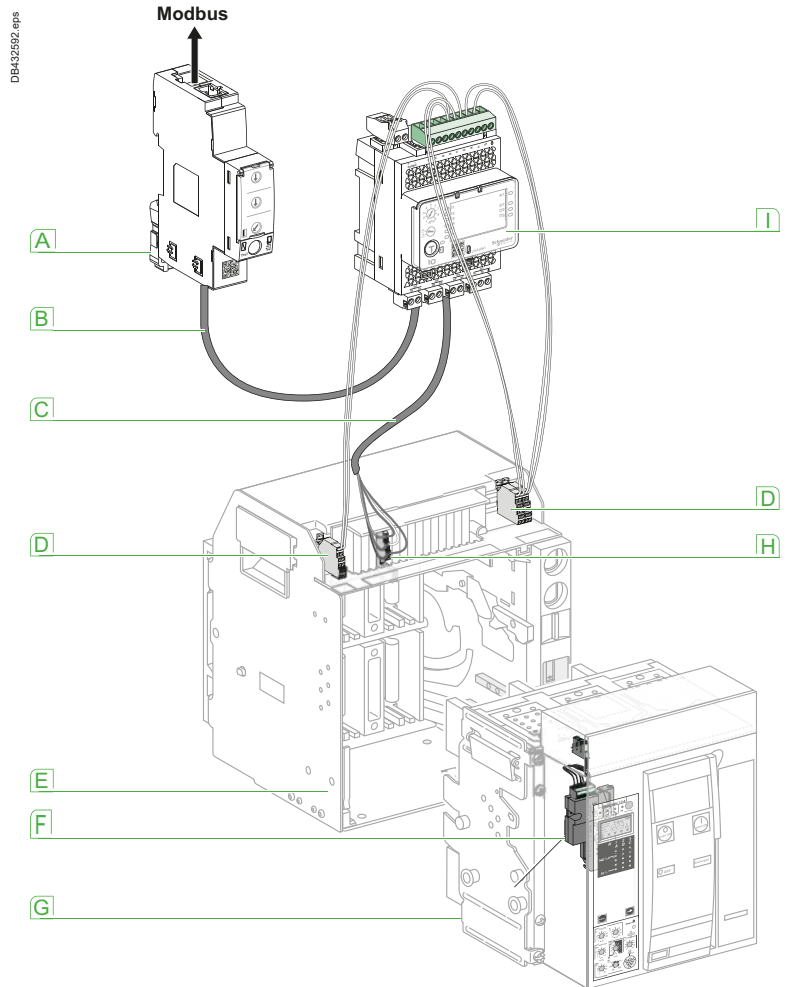
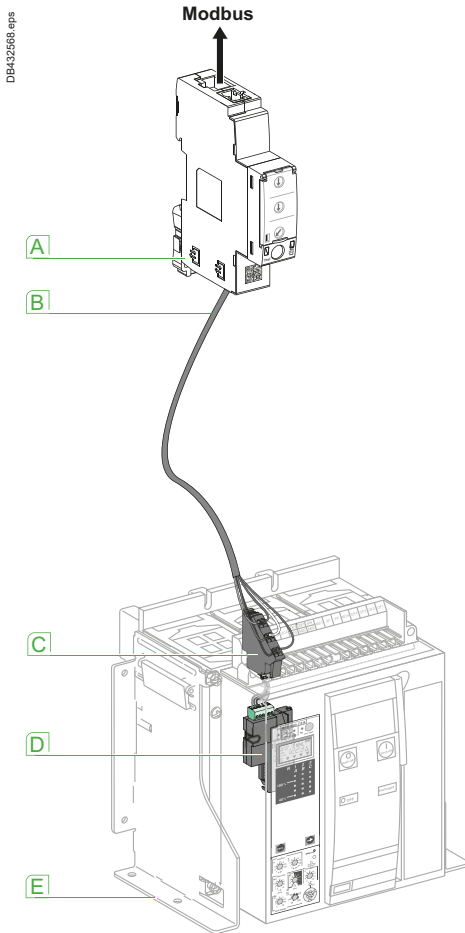

- A** IFM Ethernet interface for LV circuit breaker
- B** Breaker ULP cord
- C** Fixed COM terminal block
- D** BCM ULP communication module
- E** Fixed electrically operated circuit breaker

- A** IFM Ethernet interface for LV circuit breaker
- B** ULP cable
- C** Breaker ULP cord
- D** Drawout device position contacts
- E** Circuit breaker cradle
- F** BCM ULP communication module
- G** Drawout circuit breaker
- H** Drawout COM terminal block
- I** I/O (Input/Output) application module for LV circuit breaker



# Communication

## Electrical Asset Manager Configuration Engineering Tool

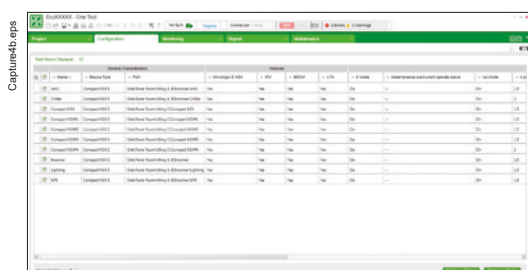
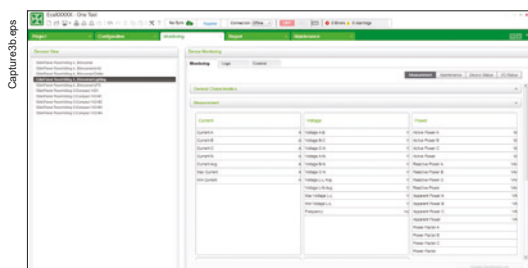
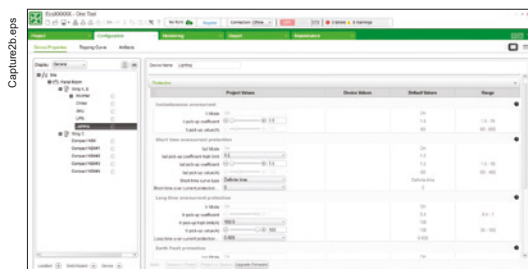
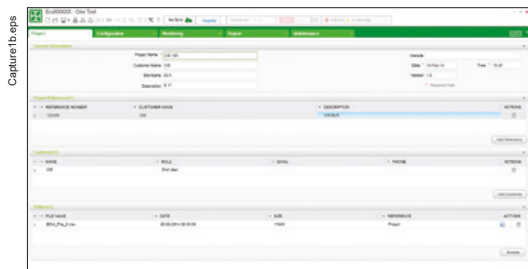

### Introduction

Electrical Asset Manager is a software application that helps the user to manage a project as part of designing, testing, site commissioning, and maintenance of the project life cycle.

It enables the user to prepare the settings of the devices offline (without connecting to the device) and configure them when connected with the devices.

It also provides several other value added features for the user to manage the project such as: repository in cloud, attach artifacts to each device or at the project level, organize devices in switchboard wise, manage a hierarchical structure of the installation.

### Compatible Devices (Configuration and Device Management)

Electrical Asset Manager is compatible with the following devices:

- ComPacT NSX100-630 (IEC)
- PowerPacTTM (UL) circuit breaker
- ComPacT NS630b-3200 (IEC)
- MasterPact NT/NW (IEC and UL) circuit breaker
- Acti9 Smartlink.
- Compatible devices (Device Management in the project)
- Switch disconnectors (ComPacT NSX, MasterPact & PowerPacT Family)
- Third party devices.

### References:

Electrical Asset Manager software package can be downloaded from our website [www.schneider-electric.com](http://www.schneider-electric.com).

### Features

Electrical Asset Manager supersedes the Schneider Electric customer engineering tools such as Remote setting Utility (RSU) and Remote Control Utility (RCU) with additional features.

Electrical Asset Manager supports the connection of Schneider Electric communicable devices to:

- Create projects by device discovery, selection of devices, and import Bill of Material (BOM)
- Monitor the status of protection and IO status
- Read information (alarms, measurements, parameters)
- Check protection selectivity between two devices
- Upload and download of configuration or settings in batch mode to multiple devices.
- Carry out commands and tests
- Generate and print device settings report and communication test report
- Manage multiple devices with electrical and communication hierarchy model
- Manage artifacts (project documents)
- Check consistency in settings between devices on a communication network
- Compare configuration settings between PC and device (online)
- Download latest firmware.

Electrical Asset Manager enables the user to avail the advanced features of the software once the project is saved in Schneider Electric cloud.

## Electrical Asset Manager Configuration Engineering Tool

### Functions

#### Offline Mode

A project can be built in offline mode through 2 different ways:

- Through BOM file import
- Through Device Selection.

Additionally, the user can open an existing project and modify the settings offline. The user can do the selectivity curve check and firmware compatibility check for devices in the project.

#### Online Mode

A project can be built in online mode through device discovery also other than the methods possible through offline method.

Once the project is built, the following functions can be performed in addition to the functions available in offline mode:

- Compare the device parameters with project parameters
- Load parameters from project to the device and vice versa
- Firmware downloads to the device
- Monitor the measurement, maintenance, device status and I/O status
- Control functions.

#### User Interface

Electrical Asset Manager software provides fast direct access to the project and the devices in the project through different tabs.

- Project: to provide the project information including customer details, project references and to add project artifacts (documents related to the project).
- Configuration: to build up the tree structure of the project architecture ; to have a table view of the devices added in the project ; to set the parameters of the devices ; to transfer the device settings ; to view the tripping curves; to attach device artifacts and to download the latest firmware, to do the communication test for all the devices and generate the test report.
- Monitoring: this allows the user to monitor the real time values of different devices through different sub tabs namely Monitoring, Logs and Control.
- Reports: report tab allows you to generate and print a report of the project settings from the report tab. The user details and project characteristics are automatically filled with the details entered in the Project page.

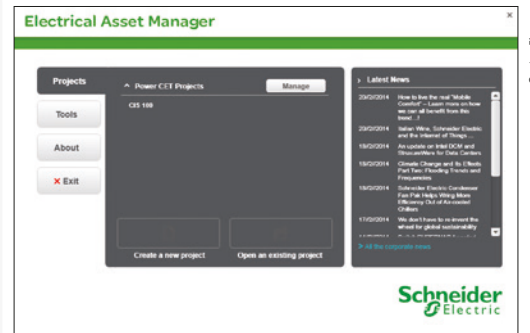

CaptureSteps

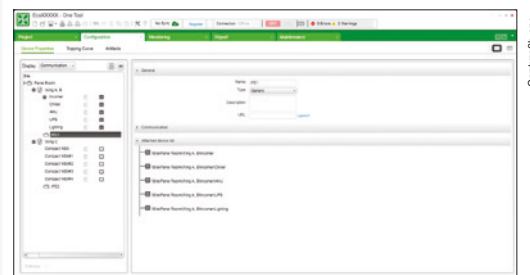

CaptureSteps

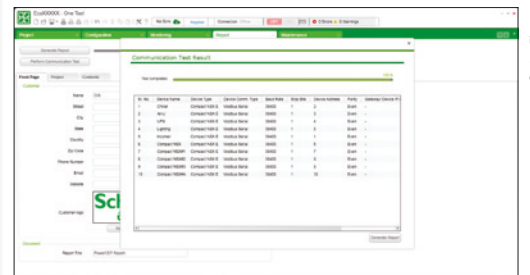

CaptureSteps

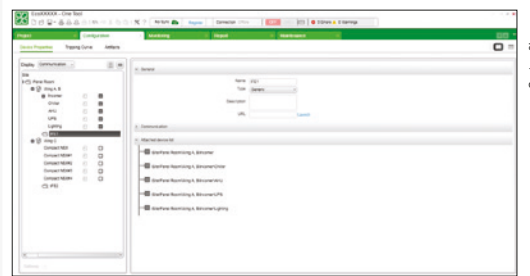

CaptureSteps

# General Characteristics of MasterPact NW DC, EPDC, DC PV

## Operating Conditions

MasterPact circuit breakers have been tested for operation in industrial atmospheres. It is recommended that the equipment be cooled or heated to the proper operating temperature and kept free of excessive vibration and dust.

A

DE431749.eps

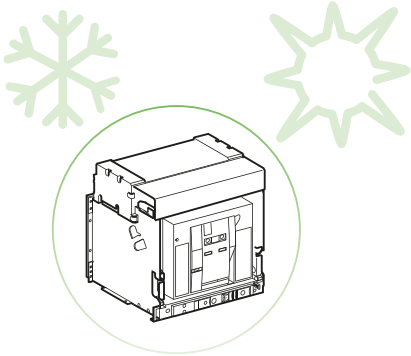

DE431750.eps

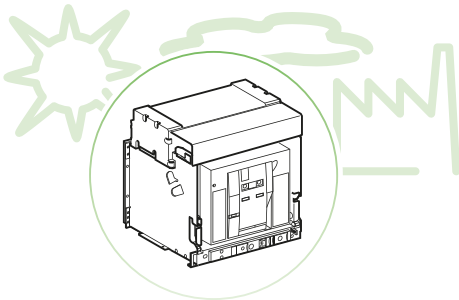

DE431751.eps

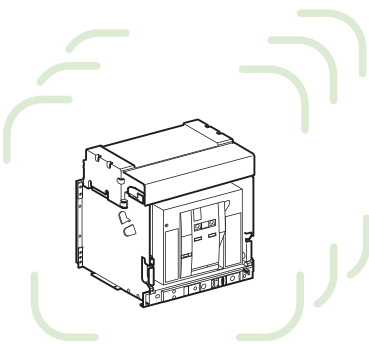

### Ambient Temperature

MasterPact devices can operate under the following temperature conditions:

- The electrical and mechanical characteristics are stipulated for an ambient temperature of -25 °C to +70 °C
- Circuit breaker closing is ensure down to -35 °C by manual operation (push button).

Storage conditions are as follows:

- -40 to +85 °C for a MasterPact device without its control unit
- -25 °C to +85 °C for the control unit.

### Severe Atmospheric Conditions

MasterPact devices have successfully passed the tests defined by the following standards for severe atmospheric conditions:

- IEC 60068-2-1: dry cold at -40 °C
- IEC 60068-2-2: dry heat at +85 °C
- IEC 60068-2-30: damp heat (temperature +55 °C, relative humidity 95 %)
- IEC 60068-2-52 level 2: salt mist.

MasterPact devices can operate in the industrial environments defined by standard IEC 60947 (pollution degree up to 3).

It is nonetheless advised to check that the devices are installed in suitably cooled switchboards without excessive dust.

### Vibrations

MasterPact devices have successfully passed testing in compliance with IEC 60068-2-6 for the following vibration levels:

- 2 to 13.2 Hz: amplitude ±1 mm
- 13.2 to 100 Hz: constant acceleration 0.7 g.

Vibration testing to these levels is required by merchant marine inspection organizations (Veritas, Lloyd's, etc). Some applications have vibration profiles outside of this standard and require special attention during application design, installation, and use. Excessive vibration may cause unexpected tripping, damage to connections or to other mechanical parts. Please refer to the MasterPact maintenance guide (causes of accelerated ageing/operating conditions/vibrations) for additional information.

Examples of applications with high vibration profiles could include:

- Wind turbines
- Power frequency converters that are installed in the same switchboard or close proximity to the MasterPact circuit breaker
- Emergency generators
- High vibration marine applications such as thrusters, anchor positioning systems, etc.



# General Characteristics of MasterPact NW DC, EPDC, DC PV

## MasterPact NW DC, EPDC, DC PV

### Altitude

At altitudes higher than 2000 metres, the modifications in the ambient air (electrical resistance, cooling capacity) lower the following characteristics as follows:

Altitude (m)	2000	3000	4000	5000	
<b>NW DC</b>					
Impulse withstand voltage $U_{imp}$ (kV)	12	10.6	9.5	8.4	
Rated insulation voltage ( $U_i$ )	1000	900	800	700	
Maximum rated operationnal voltage 50/60 Hz $U_e$ (V)	NW DC $\leq 500$ V	500	450	390	350
	NW DC 500-900 V	900	800	700	630
Rated current (A) at 40 °C	1 x $I_n$	0.98 x $I_n$	0.96 x $I_n$	0.94 x $I_n$	
<b>NW DC PV</b>					
Impulse withstand voltage $U_{imp}$ (kV)	12	10.6	9.5	8.4	
Rated insulation voltage ( $U_i$ )	1000	1000	950	850	
Maximum rated operationnal DC voltage	1000	1000	950	850	
Rated current (A) at 40 °C	1 x $I_n$	0.98 x $I_n$	0.96 x $I_n$	0.94 x $I_n$	

Intermediate values may be obtained by interpolation.

### Electromagnetic Disturbances

MasterPact NW DC devices are protected against:

- Overvoltages caused by devices that generate electromagnetic disturbances
- Overvoltages caused by atmospheric disturbances or by a distribution-system outage (e.g. failure of a lighting system)
- Devices emitting radio waves (radios, walkie-talkies, radar, etc.)
- Electrostatic discharges produced by users.

MasterPact NW DC devices have successfully passed the electromagnetic-compatibility tests (EMC) defined by the following international standards:

- IEC 60947-2, appendix F
- IEC 60947-2, appendix B (trip units with earth-leakage function).

The above tests ensure that:

- No nuisance tripping occurs
- Tripping times are respected.

### Degree of Protection

MasterPact NW DC circuit breakers offer the following protection characteristics depending on the installation conditions:

- IP: degree of protection (standard IEC 60529)
- IK: protection against external mechanical imPacTs (standard EN 50102).

#### MasterPact NW DC

##### Circuit breaker installed in a switchboard

DE104534.eps

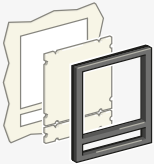

Bare circuit breaker	IP30	
Escutcheon (CDP) for fixed and drawout versions, with blanking plate	IP40	IK07

PB100776-2QR.eps

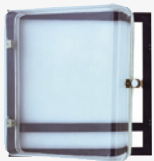

Transparent cover (CCP) for escutcheon for drawout version	IP54	IK10
--	------	------

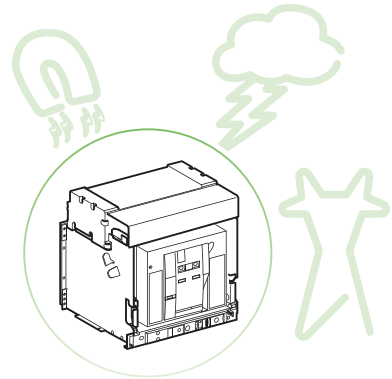
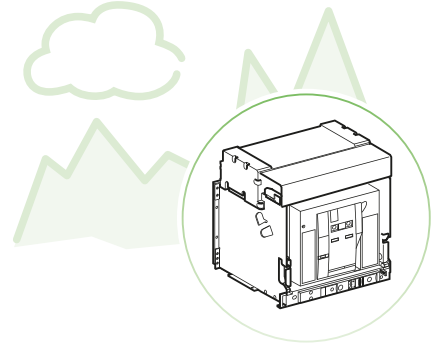

DE431752.eps

A

DE431753.eps

# General Characteristics of MasterPact NW DC, EPDC, DC PV

## MasterPact NW10 to NW40 DC

PB104817.eps



NW10 DC 3P

PB105024\_42.eps



NW10 DC 4P

A

### MasterPact NW DC Circuit Breaker

Poles coupling version	C or D (3 poles)
	E (4 poles)

#### Electrical Characteristics As Per IEC 60947-1/ 60947-2 and EN 60947-1/60947-2

Rated current at 40 °C/50 °C <sup>[1]</sup>	<b>I<sub>n</sub></b>	(A)
Rated insulation voltage	<b>U<sub>i</sub></b>	(V)
Rated impulse withstand voltage	<b>U<sub>imp</sub></b>	(kV peak)
Rated operational voltage	<b>U<sub>e</sub></b>	(V DC)

#### Type of circuit breaker

Ultimate breaking capacity	L/R = 5 ms	<b>I<sub>cu</sub></b>	(kA)	V DC	500
					750
					900
L/R = 15 ms	<b>I<sub>cu</sub></b>	500			
		750			
		900			
L/R = 30 ms	<b>I<sub>cu</sub></b>	500			
		750			
		900			

Service breaking capacity	<b>I<sub>cs</sub></b>	% I <sub>cu</sub>
Rated making capacity	<b>I<sub>cm</sub></b>	% I <sub>cu</sub>
Short-time withstand current	<b>I<sub>cw</sub></b>	1 s
Utilization category		
Breaking time		(ms)
Making time		(ms)
Suitability for isolation		
Pollution degree (as per IEC 60664-1)		

#### Protection against overcurrents (see trip unit table page D-12)

Trip units	Built-in
Protection	Overloads
	Short-circuits

#### Durability

(O/C cycles)	Mechanical	With maintenance	
		Without maintenance	
	Electrical	Without maintenance	500 V DC
			900 V DC

#### Indication and control auxiliaries

Auxiliary contacts	
Voltage release	MX shunt release
	MN undervoltage release

#### Switch-Disconnecter As Per IEC 60947-3 and EN 60947-3

##### Type of switch-disconnector

Rated making capacity	<b>I<sub>cm</sub></b>	(kA)
Rated short-time withstand current	<b>I<sub>cw</sub></b>	(kA) 1 s

#### Unprotected Circuit Breaker (500 V DC Only)

##### Tripping by Shunt Trip As Per IEC 60947-2

##### Type of unprotected circuit breaker

Ultimate breaking capacity	L/R = 6.5 ms	<b>I<sub>cu</sub></b>	(kA)	500 V DC
Short-time withstand current		<b>I<sub>cw</sub></b>	(kA)	1 s
Ultimate breaking capacity	L/R = 15 ms	<b>I<sub>cu</sub></b>	(kA)	500 V DC
Short-time withstand current		<b>I<sub>cw</sub></b>	(kA)	1 s
Service breaking capacity		<b>I<sub>cs</sub></b>	% I <sub>cu</sub>	

Overload and short-circuit protection

External protection relay: short-circuit protection, maximum delay: 500 ms

#### Installation and Connections

Connection	Drawout	3P	RC	Horizontal
		4P		Vertical
Fixed		3P	RC	Horizontal
		4P		Vertical

#### Dimensions and Weight

Dimensions	Drawout	3P
		4P
H x W x D (mm) connected in series	Fixed	3P
		4P
Weight (kg) connected in series (approximate values)	Drawout	3P
		4P
	Fixed	3P
		4P

[1] 50 °C - see the derating table for the NW40 DC.

# General Characteristics of MasterPact NW DC, EPDC, DC PV

## MasterPact NW10 to NW40 DC

A

NW10 DC		NW20 DC		NW40 DC	
<input type="checkbox"/>		<input type="checkbox"/>		<input type="checkbox"/>	
<input type="checkbox"/>		<input type="checkbox"/>		<input type="checkbox"/>	
1000		2000		4000	
1000		1000		1000	
12		12		12	
500/900		500/900		500/900	
<b>N</b>	<b>H</b>	<b>N</b>	<b>H</b>	<b>N</b>	<b>H</b>
85	100	85	100	85	100
-	85	-	85	-	85
-	85	-	85	-	85
35	85	35	85	35	85
-	50	-	50	-	50
-	35	-	35	-	35
25	50	25	50	25	50
-	50	-	50	-	50
-	25	-	25	-	25
100 %					
100 %					
50	85	50	85	50	85
B					
30 to 75					
< 70					
<input type="checkbox"/>	<input type="checkbox"/>	<input type="checkbox"/>	<input type="checkbox"/>	<input type="checkbox"/>	<input type="checkbox"/>
3					
<input type="checkbox"/>	<input type="checkbox"/>	<input type="checkbox"/>	<input type="checkbox"/>	<input type="checkbox"/>	<input type="checkbox"/>
-	-	-	-	-	-
<input type="checkbox"/>	<input type="checkbox"/>	<input type="checkbox"/>	<input type="checkbox"/>	<input type="checkbox"/>	<input type="checkbox"/>
20000					
10000					
8500		5000		2000	
-	2000	-	2000	-	1000
<input type="checkbox"/>	<input type="checkbox"/>	<input type="checkbox"/>	<input type="checkbox"/>	<input type="checkbox"/>	<input type="checkbox"/>
<input type="checkbox"/>	<input type="checkbox"/>	<input type="checkbox"/>	<input type="checkbox"/>	<input type="checkbox"/>	<input type="checkbox"/>
<input type="checkbox"/>	<input type="checkbox"/>	<input type="checkbox"/>	<input type="checkbox"/>	<input type="checkbox"/>	<input type="checkbox"/>
-	<b>HA</b>	-	<b>HA</b>	-	<b>HA</b>
-	85	-	85	-	85
-	85	-	85	-	85
<b>NW10 HADC-C 500V DC</b>		<b>NW20 HADC-C 500V DC</b>		<b>NW40 HADC-C 500V DC</b>	
85		85		85	
85		85		85	
65		65		65	
65		65		65	
100 %					
-		-		-	
<input type="checkbox"/>	<input type="checkbox"/>	<input type="checkbox"/>	<input type="checkbox"/>	-	-
<input type="checkbox"/>	<input type="checkbox"/>	<input type="checkbox"/>	<input type="checkbox"/>	<input type="checkbox"/>	<input type="checkbox"/>
<input type="checkbox"/>	<input type="checkbox"/>	<input type="checkbox"/>	<input type="checkbox"/>	-	-
<input type="checkbox"/>	<input type="checkbox"/>	<input type="checkbox"/>	<input type="checkbox"/>	<input type="checkbox"/>	<input type="checkbox"/>
439 x 441 x 494				439 x 441 x 594	
439 x 556 x 494				439 x 556 x 594	
352 x 422 x 427				352 x 422 x 527	
352 x 537 x 427				352 x 537 x 527	
90 to 116					
125 to 146					
60 to 86					
85 to 106					

# Trip Unit Characteristics

## Trip Units for MasterPact NW DC, EPDC

All MasterPact NW DC devices are equipped with a MicroLogic 1.0 DC control unit.

A

PB101139-32R.eps

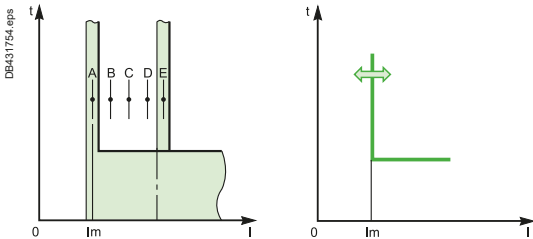

Magnetic pick-up value

### Protection Using the MicroLogic 1.0 DC Control Unit

MasterPact NW DC circuit breakers use MicroLogic 1.0 DC control units. These interchangeable units with instantaneous thresholds, operating with electromagnetic sensors, can be adjusted on site. The circuit breakers can be used with the three versions of sensors, defined by their setting range.

Type of sensor	1250/2500 A	2500/5400 A	5000/11000 A
MasterPact NW10 DC	●	●	●
MasterPact NW20 DC	-	●	●
MasterPact NW40 DC	-	-	●

### Adjustments

Settings for MasterPact NW DC circuit breakers may be accessed from the front, with the switchboard door open.

- Settings are made for the input (+ pole) and the output (- pole).
- The setting range comprises eleven positions, plus five preferential settings marked **A, B, C, D** and **E**.
- The setting values for the two corresponding sensors must be identical.

DB431755.eps

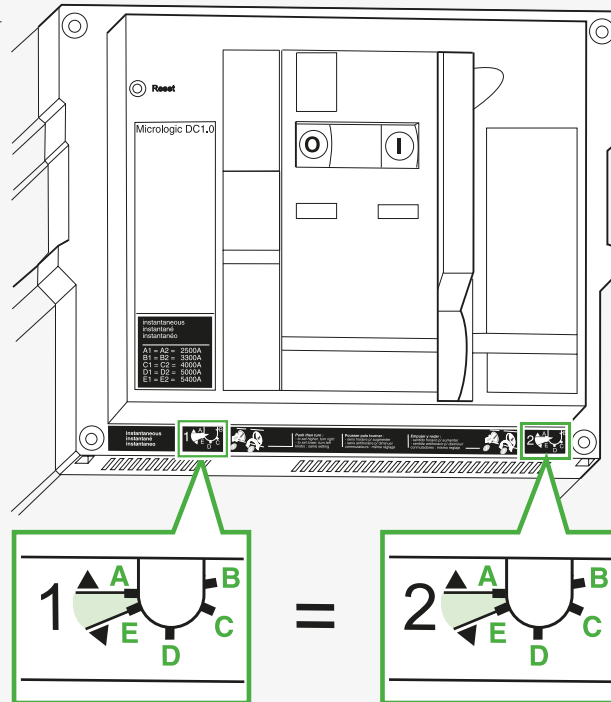

Two identical settings

# Functions and Characteristics

## Trip Unit Characteristics

### Trip Units for MasterPact NW DC, EPDC

### Setting Values for Magnetic Pick-up Ii

Settings Marked A, B, C, D and E

Sensor versions	Minimum				Maximum
	Settings A1 and A2	Settings B1 and B2	Settings C1 and C2	Settings D1 and D2	Settings E1 and E2
1250/2500	1250 A	1500 A	1600 A	2000 A	2500 A
2500/5400	2500 A	3300 A	4000 A	5000 A	5400 A
5000/11000	5000 A	8000 A	10000 A	11000 A	11000 A
Tolerances	±8 %	±10 %	±10 %	±10 %	±10 %

instantaneous  
instantané  
instantaneo :

---

**A<sub>1</sub> = A<sub>2</sub> = 2500A**  
**B<sub>1</sub> = B<sub>2</sub> = 3300A**  
**C<sub>1</sub> = C<sub>2</sub> = 4000A**  
**D<sub>1</sub> = D<sub>2</sub> = 5000A**  
**E<sub>1</sub> = E<sub>2</sub> = 5400A**

DB431756 eps

instantaneous  
instantané  
instantaneo :

**A<sub>1</sub> = A<sub>2</sub> = 5000A**  
**B<sub>1</sub> = B<sub>2</sub> = 8000A**  
**C<sub>1</sub> = C<sub>2</sub> = 10000A**  
**D<sub>1</sub> = D<sub>2</sub> = 11000A**  
**E<sub>1</sub> = E<sub>2</sub> = 11000A**

### Intermediate Settings

It is possible to set eleven other (unmarked) intermediate values.

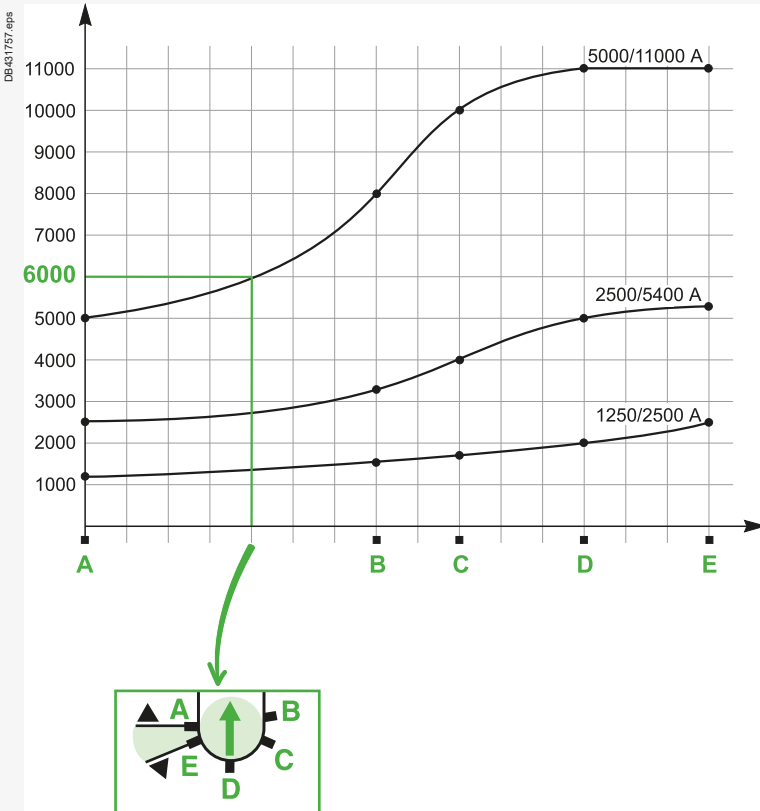

DB1104542 eps



# Switch-Disconnectors for PV Application

## MasterPact NW HADCD-PV

PE11349\_32.eps



MasterPact NW20 HADCD-PV

A

DB416572.eps

**Masterpact NW20 HADCD-PV**

Ui 1000V Uimp 12kV

Ue 1000 V  $\approx$  3P in series

Icw 85kA/1s

Icm 85kA

---

IEC 60947-3

Ith 2000A 55°C

Ue (V) Ie (A)

DC22A 1000 2000

MasterPact NW20 HADCD-PV rating plate

DB416460.eps

**Masterpact NW40 HADCD-PV**

Ui 1000V Uimp 12kV

Ue 1000 V  $\approx$  3P in series

Icw 85kA/1s

Icm 85kA

---

IEC 60947-3

Ith 4000A 45°C

Ue (V) Ie (A)

DC22A 1000 4000

MasterPact NW40 HADCD-PV rating plate

MasterPact NW HADCD-PV Switch-Disconnectors for PV Application		NW20 HADCD-PV	NW40 HADCD-PV		
Poles coupling version	D (3 poles)	⊙	⊙		
<b>Electrical Characteristics As Per IEC 60947-1/60947-3 and EN 60947-1/60947-3</b>					
Rated current at 40/45 °C	In (A)	2000	4000		
Rated insulation voltage	Ui (V)	1000	1000		
Rated impulse withstand voltage	Uimp (kV peak)	12	12		
Rated operational voltage	Ue (V DC)	1000 [1]	1000 [1]		
<b>Switch-disconnector as per IEC 60947-3 and EN 60947-3</b>					
Rated making capacity	Icm (kA)	85	85		
Rated short-time withstand current	Icw (kA/1 s)	85	85		
Utilization category		DC-22A	DC-22A		
<b>Durability</b>					
(O/C cycles)	Mechanical	with maintenance	20000	20000	
		without maintenance	10000	10000	
	Electrical	without maintenance	2000	1000	
		1000 V DC L/R = 2 ms			
<b>Installation and connections</b>					
Connection	Fixed	rear connections	Vertical	⊙	⊙
			Horizontal	⊙	-
Drawout	rear connections		Vertical	⊙	⊙
			Horizontal	⊙	-
<b>Dimensions and weight</b>					
Dimensions	Fixed	3P	352 x 422 x 427	352 x 422 x 527	
H x W x D (mm) with the series connection	Drawout	3P	439 x 441 x 494	439 x 441 x 594	
Weight (kg)	Fixed	3P	60 to 86		
with the series connection (approximate values)	Drawout	3P	90 to 116		

All the accessories of the standard NW HADC switch-disconnectors can be used.

[1] NW HADCD-PV switch-disconnectors for PV applications are designed and qualified to break the rated or the fault current under 1000 V DC with all the 3 poles in series and this is a mandatory condition whatever the type of fault. This comes to say that the PV systems using these switch-disconnectors must be isolated systems from the earth and that the double fault situation (A and D or C and E on the diagram below) must be absolutely avoided: insulation monitoring devices shall detect the first fault and the staff shall look for this first fault and clear it with no delay. These switch-disconnectors cannot be used in grounded systems as in this situation they may be expected to break the current under the full voltage (1000 V DC) with only 1 pole or 2 poles in series. These devices are not designed for that purpose and could sustain irremediable damage if used to break in these conditions.

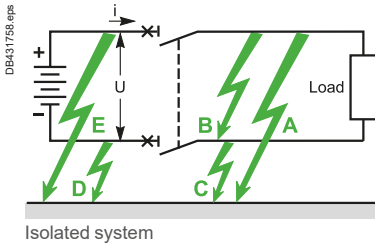



# Switch-Disconnectors for PV Application

## MasterPact NW HADCD-PV - Connections and Safety Clearances

A

### Fixed Version, Vertical Rear Connections

NW20 HADCD-PV

NW40 HADCD-PV

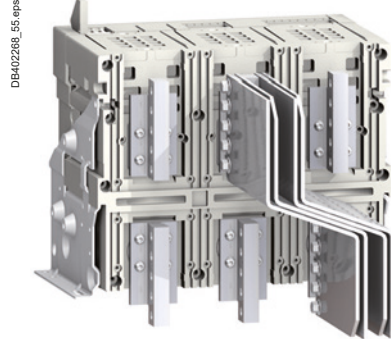
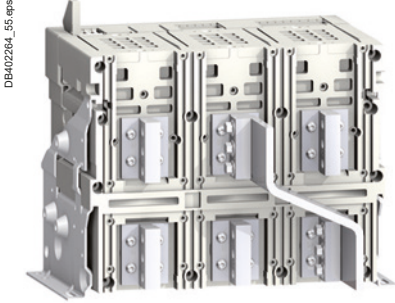

#### Safety clearances

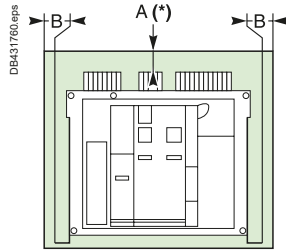
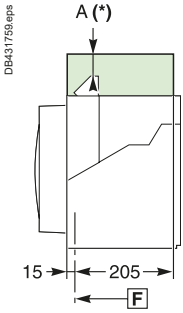

	Insulated parts	Metal parts	Energized parts
A	0	0	100
B	0	0	60

**F** Datum

**A(\*)** An overhead clearance of 110 mm is required to remove the arc chutes. An overhead clearance of 20 mm is required to remove the terminal block.

### Drawout Version, Vertical Rear Connections

NW20 HADCD-PV

NW40 HADCD-PV

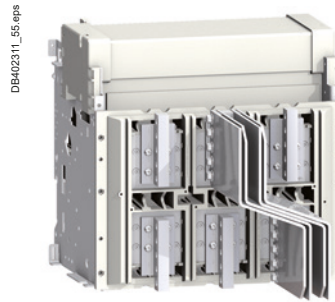

#### Safety clearances

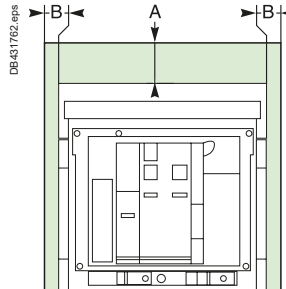
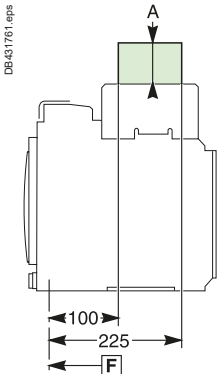

	Insulated parts	Metal parts	Energized parts
A	0	0	0
B	0	0	60

**F** Datum

# MasterPact NW EPDC-D Circuit Breakers for Marine Applications at 1100 V DC

## MasterPact NW EPDC-D General Characteristics

MasterPact NW EPDC-D Circuit Breaker				NW10 EPDC-D	NW20 EPDC-D	NW40 EPDC-D
Poles coupling version		D (3 poles in series)		<input checked="" type="radio"/>	<input checked="" type="radio"/>	<input checked="" type="radio"/>
<b>Electrical Characteristics As Per IEC 60947-1/60947-2 and EN 60947-1/60947-2</b>						
Rated current at 40°/45°C	<b>I<sub>n</sub></b>	(A)		1000	2000	4000
Rated insulation voltage	<b>U<sub>i</sub></b>	(V)		1250	1250	1250
Rated impulse withstand voltage	<b>U<sub>imp</sub></b>	(kV peak)		12	12	12
Rated operational voltage	<b>U<sub>e</sub></b>	(V DC)		1100 [1]	1100 [1]	1100 [1]
<b>Circuit breaker as per IEC 60947-2 and EN 60947-2</b>						
Ultimate breaking capacity	L/R = 15 ms	<b>I<sub>cu</sub></b>	(kA)	65	65	65
Service breaking capacity		<b>I<sub>cs</sub></b>	%I <sub>cu</sub>	100%	100%	100%
Rated making capacity		<b>I<sub>cm</sub></b>	%I <sub>cu</sub>	100%	100%	100%
Rated short-time withstand current (kA rms)		<b>I<sub>cw</sub></b>	(kA/1s)	65	65	65
Selectivity category				A	A	A
Breaking time			(ms)	30 to 75	30 to 75	30 to 75
Making time			(ms)	<70	<70	<70
Suitability for isolation				<input checked="" type="radio"/>	<input checked="" type="radio"/>	<input checked="" type="radio"/>
Pollution degree (as per IEC 60664-1)				3	3	3
<b>Protection against overcurrents (see trip unit table next page)</b>						
Trip units	Built-in			<input checked="" type="radio"/>	<input checked="" type="radio"/>	<input checked="" type="radio"/>
Protection	Overloads			-	-	-
	Short-circuits			<input checked="" type="radio"/>	<input checked="" type="radio"/>	<input checked="" type="radio"/>
<b>Durability</b>						
(O/C cycles)	Mechanical	With maintenance		20000	20000	20000
		Without maintenance		10000	10000	10000
	Electrical	Without maintenance 1100 V DC		1000	1000	1000
<b>Indication and control auxiliaries</b>						
Auxiliary contacts				<input checked="" type="radio"/>	<input checked="" type="radio"/>	<input checked="" type="radio"/>
Voltage release	MX shunt release			<input checked="" type="radio"/>	<input checked="" type="radio"/>	<input checked="" type="radio"/>
	MN undervoltage release			<input checked="" type="radio"/>	<input checked="" type="radio"/>	<input checked="" type="radio"/>
<b>Installation and Connections</b>						
Connection	Drawout	Rear connections	Horizontal	<input checked="" type="radio"/>	<input checked="" type="radio"/>	-
			Vertical	<input checked="" type="radio"/>	<input checked="" type="radio"/>	<input checked="" type="radio"/>
<b>Dimensions and Weight</b>						
Dimensions	Drawout	3P		439 x 441 x 494	439 x 441 x 494	439 x 441 x 594
H x W x D (mm) with the series connection						
Weight (kg) with the series connection (approximate values)	Drawout	3P		90 to 116		

A

**MasterPact**  
**NW20 EPDC-D**

**U<sub>i</sub> 1250V**      **U<sub>imp</sub> 12kV**

**U<sub>e</sub> 1100 V** **3P in series**

**I<sub>cu</sub> 65kA (L/R 15ms)**

**I<sub>cs</sub> 100% I<sub>cu</sub>**      **cat.A**

**IEC 60947-2**      **GB/T 14048.2**

All the accessories of the standard NW HDC circuit breakers can be used.  
**NW EPDC-D circuit breakers were not designed for and cannot be used in PV application.**

[1] NW EPDC-D circuit breakers are designed and qualified to break the rated or the fault current under 1100V DC with all the 3 poles in series, and having the 3 poles in series when breaking is a mandatory condition whatever the type of fault.

This implies 2 mandatory conditions:  
 ■ the systems using these circuit breakers must be isolated from the earth.  
 ■ avoid the double fault situation (A and D or C and E on the diagram above). For this, insulation monitoring devices must detect the first fault, and the staff must locate it and clear it with no delay.

These circuit breakers cannot be used in grounded systems as, in this situation, they may be expected to break the current under the full voltage (1100 V DC) with only 1 pole or 2 poles in series. These devices are not designed for that purpose and could sustain irremediable damage if used to break in these conditions.

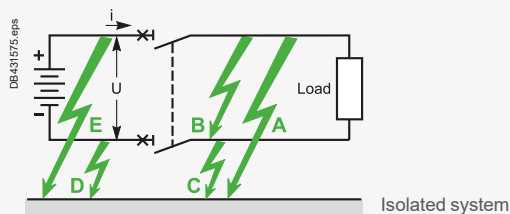

# MasterPact NW EPDC-D Circuit Breakers for Marine Applications at 1100 V DC



## Connections, Dimensions and Safety Clearances

### Horizontal rear connection (NW10/20 EPDC-D)



DB431892.eps

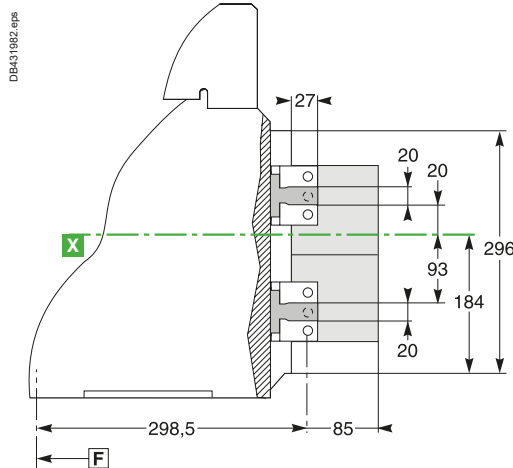

DB431892.eps

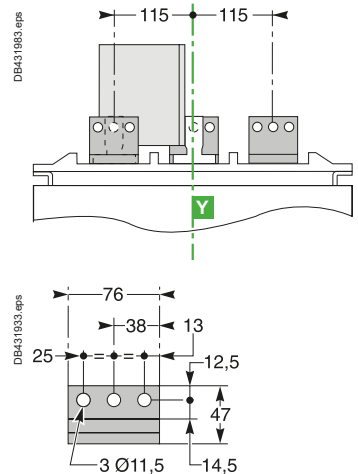

DB431893.eps

DB431933.eps

### Vertical rear connection (NW10/20 EPDC-D)

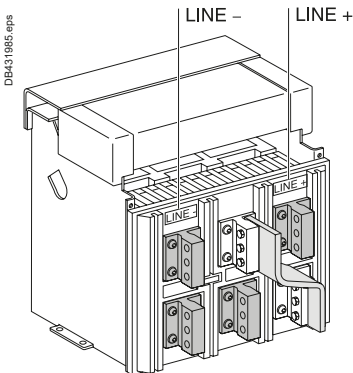

DB431985.eps

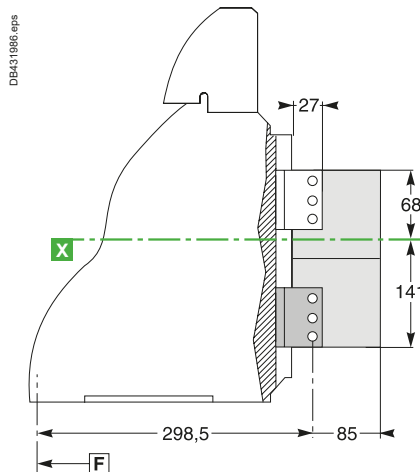

DB431986.eps

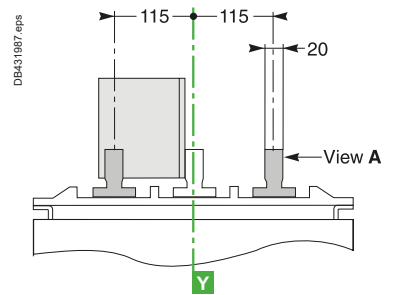

DB431987.eps

DB431938.eps

View A detail

### Vertical rear connection (NW40 EPDC-D)

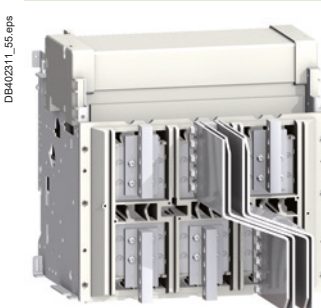

DB431940.eps

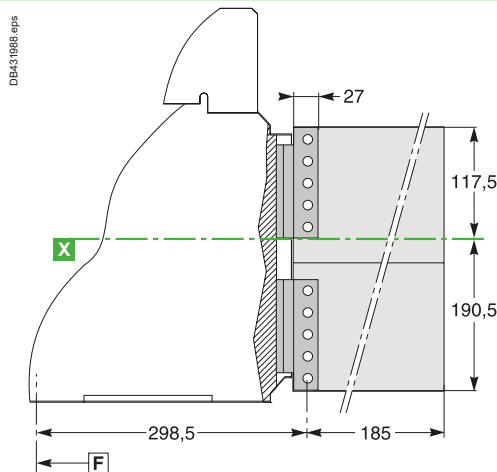

DB431988.eps

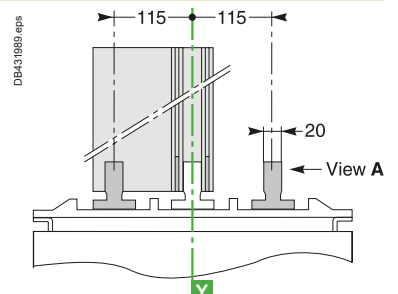

DB431989.eps

DB431940.eps

View A detail

**Note:** Recommended connection screws: M10 class 8.8.  
Tightening torque: 50 Nm with contact washer.

# Panorama of Electrical and Mechanical Accessories

## MasterPact NW10 to NW40 DC

All MasterPact NW DC devices exist in Circuit breaker (equipped with MicroLogic DC 1.0 control unit) and switch-disconnector versions. All auxiliaries are common from 1000 to 4000 A.

A

- A** OFF pushbutton
- B** ON pushbutton
- C** Closing mechanism charging handle
- D** Operation counter
- E** Operating mechanism charged and "ready to close" indication:
  - Spring charged
  - Spring discharged

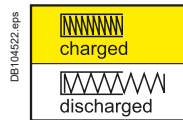

- F** Main contact position indication:
  - ON
  - OFF

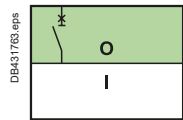

- G** Fault trip indication and reset button
- H** MicroLogic 1.0 DC control unit
- I** Racking interlock
- J** Racking-handle storage
- K** Shutter position indication and locking
- L** "Connected/test/disconnected" position indication
- M** Racking-handle port
- N** Reset pushbutton
- O** Padlock locking
- P** Keylock locking

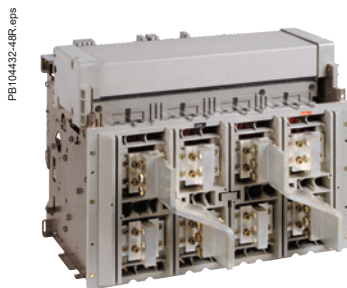
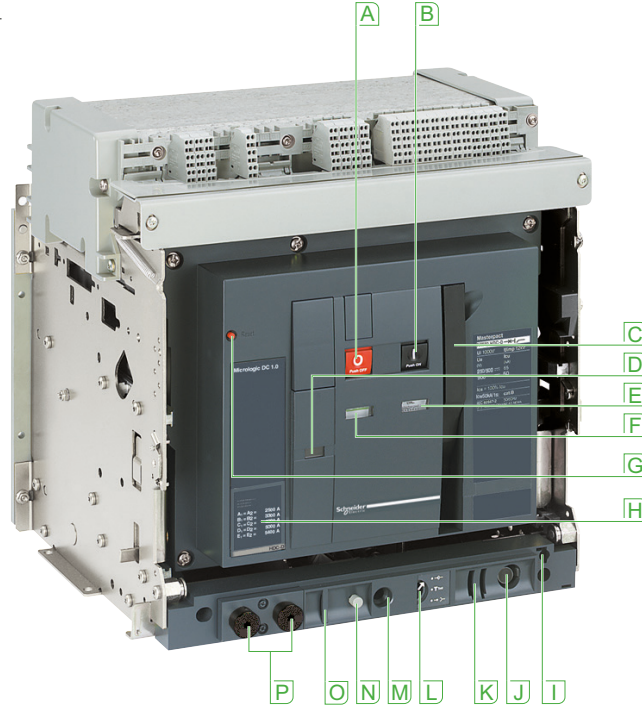

Vertical rear connection

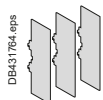

### Circuit Breakers and Switch-Disconnectors

- MasterPact NW DC exists in fixed and withdrawable versions:
- Circuit breaker equipped with MicroLogic 1.0 DC control unit
  - Switch-disconnector without the control unit.

### Common Auxiliaries from 1000 to 4000 A

All accessories are:

- Accessible from the front in a compartment isolated from the power circuits
- Secured by a single screw
- No adjustments
- Adaptable on site.

### Communication

Circuit breaker or switch-disconnector integration in a supervision system requires the COM option.

MasterPact uses the Modbus communication protocol compatible with ION-E electrical engineering expert system software.

An external gateway is available for communication with other networks (Profibus, Ethernet, etc.).

### Connections

- Rear vertical connection in standard.
- Possibility of conversion to horizontal connection by turning the connectors On the site by the customer (except for the NW40).
- Prefabricated series connections.
- Safety shutters, shutter locking blocks.
- Optional accessories:
  - Interphase barriers
  - Shutter position indication and locking.

# Panorama of Electrical and Mechanical Accessories MasterPact NW10 to NW40 DC

## Locking

- Pushbutton locking by padlockable transparent cover.
- OFF-position locking by padlock or keylock.
- Chassis locking:
  - In disconnected position by keylock
  - In connected, disconnected and test positions.
- Door interlock (inhibits door opening with breaker in connected position).
- Racking interlock (inhibits racking with door open).
- Racking interlock between crank and OFF pushbutton.
- Automatic spring discharge before breaker removal.
- Mismatch protection.



PB104387A32.eps



PB104966A32.eps

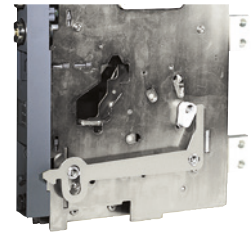

PB100780\_32R\_SE.eps

Locking in disconnected position by keylock or padlock

Door interlock (inhibits door opening with breaker in connected position)



## Indication Contacts

- Standard or low-level contacts:
  - ON/OFF indication (OF)
  - "fault-trip" indication (SDE)
  - Carriage switches for connected (CE), disconnected (CD) and test (CT) positions.

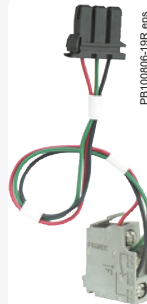

PB100806-10R.eps

OF contact (microswitch)



PB100807-12R.eps

OF contact (rotary)

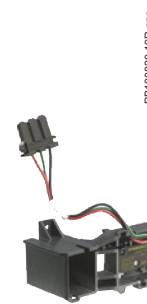

PB100820-10R.eps

SDE contact



PB100816-10R.eps

Combined contact (connected/closed)

## Remote Operation

- Remote ON/OFF:
  - Gear motor
  - XF closing or MX opening voltage releases
  - PF ready-to-close contact
  - Options:
    - RAR automatic or Res electrical remote reset
    - BPFE electrical closing pushbutton.
- Remote tripping function:
  - MN voltage release:
    - standard
    - adjustable or non-adjustable delay
  - Or 2<sup>nd</sup> MX voltage release.

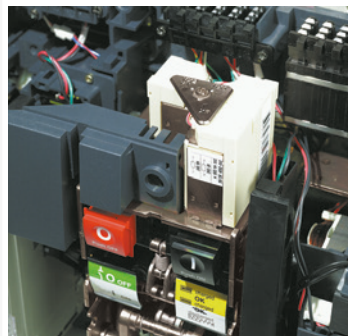

PB104349A455.eps

Remote ON/OFF



PB100808-22R.eps

Gear motor



PB100809-11R.eps

Voltage releases (MX and XF)



PB100818-11R.eps

PF ready-to-close contact

## Accessories

- Auxiliary terminal shield.
- Operation counter.
- Escutcheon.
- Transparent cover for escutcheon.
- Escutcheon blanking plate.



Operation counter

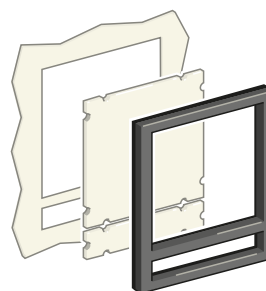

DB104524.eps

Escutcheon with blanking plate

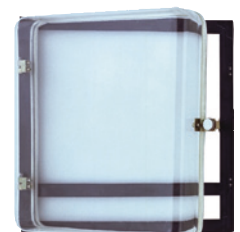

PB100776-29R.eps

Transparent cover

**Note:** For safety clearances and door cutout see page C-37.



# Connection

## Overview of Solutions

Two types of connection are available: vertical connection is standard however the connectors can be rotated for on-site conversion to horizontal connection (except for NW40).

### Rear Connection Fixed Device

#### MasterPact NW DC

##### Vertical rear connection

PB106026.eps

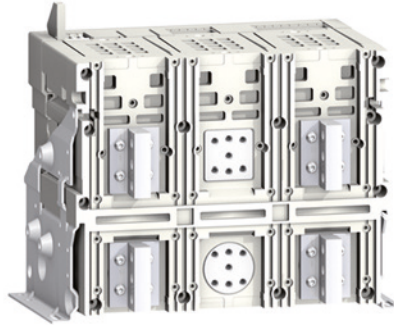

##### Horizontal rear connection

PB106025.eps

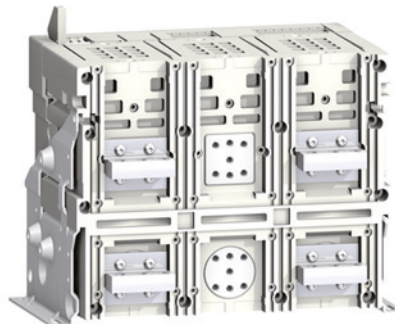





#### Rear Connection Withdrawable Device

MasterPact NW DC

#### Horizontal rear connection

DB402291\_59.eps

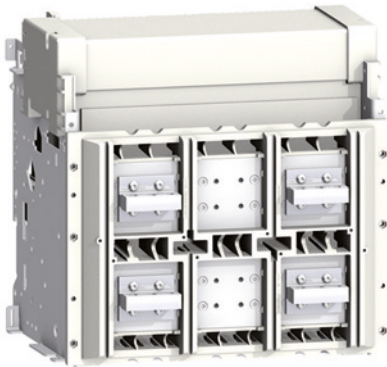

DB402303\_59.eps

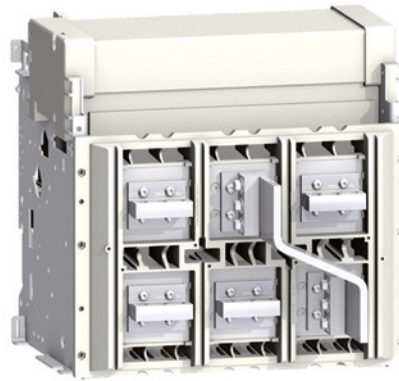

#### Vertical rear connection

PB104920\_59.eps

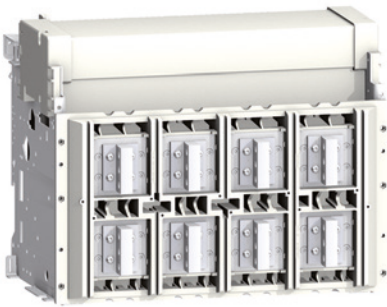

DB402323\_59.eps

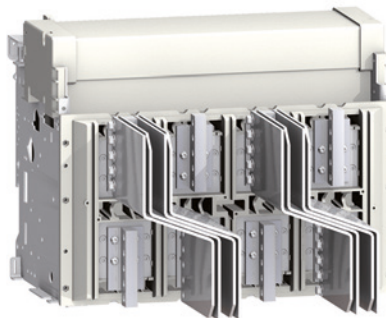

# Electrical and Mechanical Accessories

## MasterPact NW10 to NW40 DC

A

### Locking on the Device

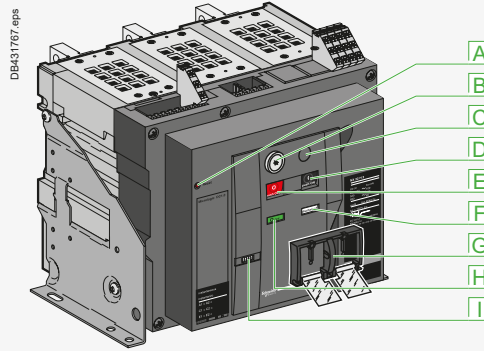

- A** Fault trip indication and reset button
- B** OFF position locking
- C** Electrical closing pushbutton
- D** ON pushbutton
- E** OFF pushbutton
- F** Operating mechanism charged and "ready to close" indication
- G** Pushbutton locking
- H** Main contact position indication
- I** Operation counter



Access to pushbuttons protected by transparent cover



Pushbutton locking using a padlock



OFF position locking using a padlock

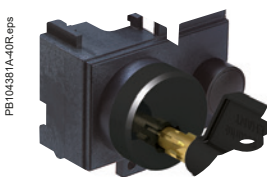

OFF position locking using a keylock

### Pushbutton Locking VBP

The transparent cover blocks access to the pushbuttons used to open and close the device.

It is possible to independently lock the opening button and the closing button. The locking device is often combined with a remote operating mechanism.

The pushbuttons may be locked using either:

- Three padlocks (not supplied)
- Lead seal
- Two screws.

### Device Locking in the OFF Position VCPO - by Padlocks - VSPO - by Keylocks

The circuit breaker is locked in the OFF position by physically maintaining the opening pushbutton pressed down:

- Using padlocks (one to three padlocks, not supplied)
- Using keylocks (one or two different keylocks, supplied).

Keys may be removed only when locking is effective (Profalux or Ronis type locks).

The keylocks are available in any of the following configurations:

- One keylock
- One keylock mounted on the device + one identical keylock supplied separately for interlocking with another device
- Two different key locks for double locking.

Profalux and Ronis keylocks are compatible with each other.

A locking kit (without locks) is available for installation of one or two keylocks (Ronis, Profalux, Kirk or Castell).

#### Accessory-compatibility

3 padlocks and/or 2 keylocks.

### Cable-Type Door Interlock IPA

This option prevents door opening when the circuit breaker is closed and prevents circuit breaker closing when the door is open.

For this, a special plate associated with a lock and a cable is mounted on the right side of the circuit breaker.

With this interlock installed, the source changeover function cannot be implemented.

This option is identical for fixed or drawout versions.

# Functions and Characteristics

## Electrical and Mechanical Accessories

### MasterPact NW10 to NW40 DC

#### Locking on the Chassis

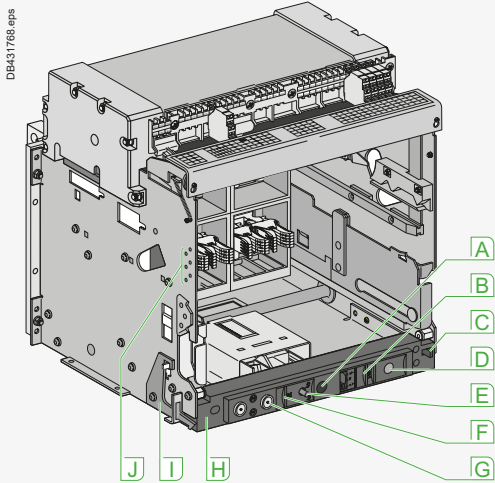

- A** Racking-handle port
- B** "Connected/test/disconnected" position indication
- C** Racking interlock
- D** Racking-handle storage
- E** Reset pushbutton
- F** Padlock locking
- G** Keylock locking
- H** Chassis front plate (accessible with cubicle door closed)
- I** "Disconnected" position door interlock
- J** Mismatch protection

#### "Disconnected" Position Locking By Padlocks (Standard) or Keylocks (VSPD Option)

The circuit breaker can be locked in its disconnected position by using the locks on the chassis. This feature is accessible via the cut out door closed.

Two options are available:

- Using padlocks (standard), up to three padlocks (not supplied)
- Using keylocks (optional), one or two different keylocks are available.

Profalux and Ronis keylocks are available in different options:

- One keylock
- Two different keylocks for double locking
- One (or two) keylocks mounted on the chassis + one (or two) identical keylocks supplied separately for interlocking with another device.

A locking kit (without locks) is available for installation of one or two keylocks (Ronis, Profalux, Kirk or Castell).

#### Connected", "Disconnected" and "Test" Position Locking

The "connected", "disconnected" and "test" positions are shown by an indicator and are mechanically indexed. The exact position is obtained when the racking handle blocks. A release button is used to free it.

As standard, the circuit breaker can be locked only in "disconnected" position by padlocks or by keylocks. On request, the locking system may be modified to lock the circuit breaker in any of the three positions "connected", "disconnected" or "test".

#### Door Interlock Catch VPEC

Mounted on the right or left-hand side of the chassis, this device inhibits opening of the cubicle door when the circuit breaker is in "connected" or "test" position. If the breaker is put in the "connected" position with the door open, the door may be closed without having to disconnect the circuit breaker.

#### Racking Interlock VPOC

This device prevents insertion of the racking handle when the cubicle door is open.

#### Cable-Type Door Interlock IPA

This option is identical for fixed and drawout versions.

#### Racking Interlock between Crank and OFF Pushbutton IBPO for NW DC

This option makes it necessary to press the OFF pushbutton in order to insert the racking handle and holds the device open until the handle is removed.

#### Automatic Spring Discharge Before Breaker Removal DAE for NW DC

This option discharges the springs before the breaker is removed from the chassis.

#### Mismatch Protection V DC

Mismatch protection ensures that a circuit breaker is installed only in a chassis with compatible characteristics. It is made up of two parts (one on the chassis and one on the circuit breaker) offering twenty different combinations that the user may select.



Racking interlock

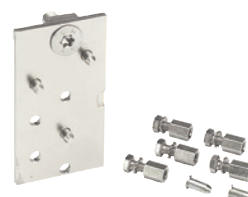

Mismatch protection

A

PB104737A.eps

PB100815-32P\_SE.eps

# Electrical and Mechanical Accessories

## MasterPact NW10 to NW40 DC

Indication contacts are available:

- In the standard version for relay applications
- In a low-level version for control of PLCs and electronic circuits.

A

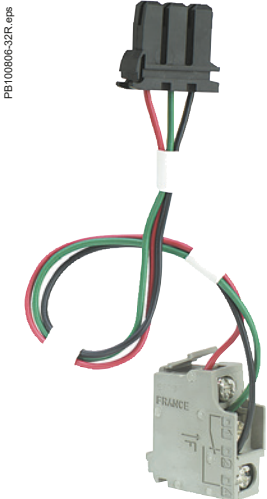

ON/OFF indication contacts OF (microswitch type)



ON/OFF indication contacts OF (rotary type)

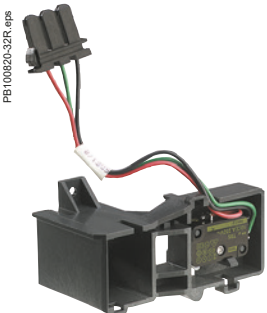

Additional "fault-trip" indication contacts SDE

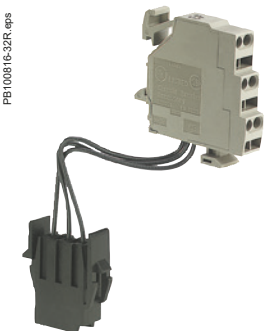

Combined contacts

### Indication Contacts

#### ON/OFF Indication Contacts OF

Rotary type changeover contacts directly driven by the mechanism. These contacts trip when the minimum isolation distance between the main Circuit breaker contacts is reached.

OF			
Supplied as standard			4
Maximum number			12
Breaking capacity (A) p.f.: 0.3 AC12/DC12	Standard	V AC	240/380
			10/6 <sup>[1]</sup>
		480	10/6 <sup>[1]</sup>
		690	6
	Low-level	V DC	24/48
			10/6 <sup>[1]</sup>
			125
			250
			3
			minimum load: 2 mA/15 V
	Low-level	V AC	24/48
			240
			380
			6
			3
	Low-level	V DC	24/48
			125
			250
			6
			3

[1] Standard contacts: 10 A; optional contacts: 6 A.

#### "Fault-Trip" Indication Contacts SDE

Circuit breaker tripping due to a fault is signalled by:

- A red mechanical fault indicator (reset)
- One changeover contact SDE.

Following tripping, the mechanical indicator must be reset before the circuit breaker may be closed. One SDE is supplied as standard. An optimal SDE may be added. This latter is incompatible with the electrical reset after fault-trip option (Res).

SDE			
Supplied as standard			1
Maximum number			2
Breaking capacity (A) p.f.: 0.3 AC12/DC12	Standard	V AC	240/380
			6
		480	2
	Low-level	V DC	24/48
			3
			125
			0.3
			0.15
	Low-level	V AC	24/48
			240
			380
			3
			3
	Low-level	V DC	24/48
			125
			250
			3
			0.3
			0.15

# Electrical and Mechanical Accessories

## MasterPact NW10 to NW40 DC

### Combined “Connected/Closed” Contacts EF

The contact combines the “device connected” and the “device closed” information to produce the “circuit closed” information. Supplied as an option for MasterPact NW DC, it is mounted in place of the connector of an additional OF contact.

EF				
Maximum number			8	
Breaking capacity (A) p.f.: 0.3 AC12/DC12	Standard	V AC	240/380	6
			480	6
			690	6
		V DC	24/48	2.5
			125	0.8
			250	0.3
	Low-level	V AC	24/48	5
			240	5
			380	5
		V DC	24/48	2.5
			125	0.8
			250	0.3

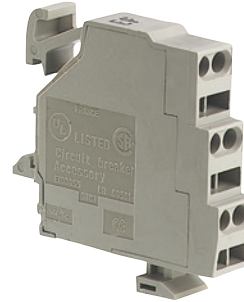

CE, CD and CT “connected/disconnected/test” position carriage switches

PB100817-32R-eps

A

### “Connected”, “Disconnected” and “Test” Position Carriage Switches

Three series of optional auxiliary contacts are available for the chassis:

- Changeover contacts to indicate the “connected” position CE
- Changeover contacts to indicate the “disconnected” position CD. This position is indicated when the required clearance for isolation of the power and auxiliary circuits is reached.
- Changeover contacts to indicate the “test” position CT. In this position, the power circuits are disconnected and the auxiliary circuits are connected.

#### Additional actuators

A set of additional actuators may be installed on the chassis to change the functions of the carriage switches.

Contacts		CE	CD	CT
Maximum number	Standard with additional actuators	3	3	3
		9	0	0
		6	3	0
		6	0	3
		3	6	0
Breaking capacity (A) p.f.: 0.3 AC12/DC12	Standard	minimum load: 100 mA/24 V		
		V AC	240	8
			380	8
			480	8
		V DC	24/48	2.5
			125	0.8
	250		0.3	
	Low-level	minimum load: 2 mA/15 V		
		V AC	24/48	5
			240	5
			380	5
		V DC	24/48	2.5
125			0.8	
250	0.3			

# Electrical and Mechanical Accessories

## MasterPact NW10 to NW40 DC

Two solutions are available for remote operation of MasterPact devices:

- A point-to-point solution
- A bus solution with the COM communication option.

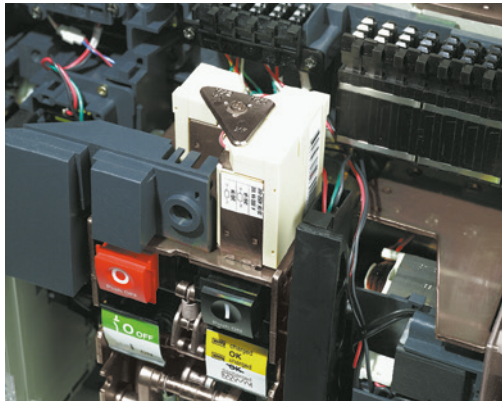

A

### Remote Operation: Remote ON/OFF

The remote ON/OFF function is used to remotely open and close the circuit breaker. It is made up of:

- An electric motor MCH equipped with a "springs charged" limit switch contact CH
- Two voltage releases:
  - A closing release XF
  - An opening release MX.

Optionally, other functions may be added:

- A "ready to close" contact PF
- An electrical closing pushbutton BPFE
- Remote RES following a fault.

A remote-operation function is generally combined with:

- Device ON/OFF indication OF
- "fault-trip" indication SDE.

**Note:**

An opening order always takes priority over a closing order. If opening and closing orders occur simultaneously, the mechanism discharges without any movement of the main contacts. The circuit breaker remains in the open position (OFF).

In the event of maintained opening and closing orders, the standard mechanism provides an anti-pumping function by blocking the main contacts in open position.

Anti-pumping function. After fault tripping or intentional opening using the manual or electrical controls, the closing order must first be discontinued, then reactivated to close the circuit breaker.

When the automatic reset after fault trip (RAR) option is installed, to avoid pumping following a fault trip, the automatic control system must take into account the information supplied by the circuit breaker before issuing a new closing order or blocking the circuit breaker in the open position. (information on type of fault: overload, short time delay, earth-leakage fault, fault vigi or short-circuit, etc.)

### Wiring diagram of a point-to-point remote ON/OFF function

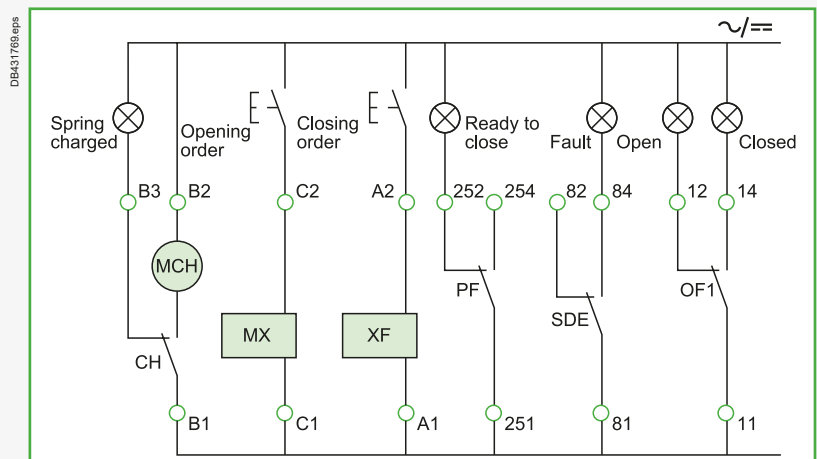

### Wiring diagram of a bus-type remote ON/OFF function

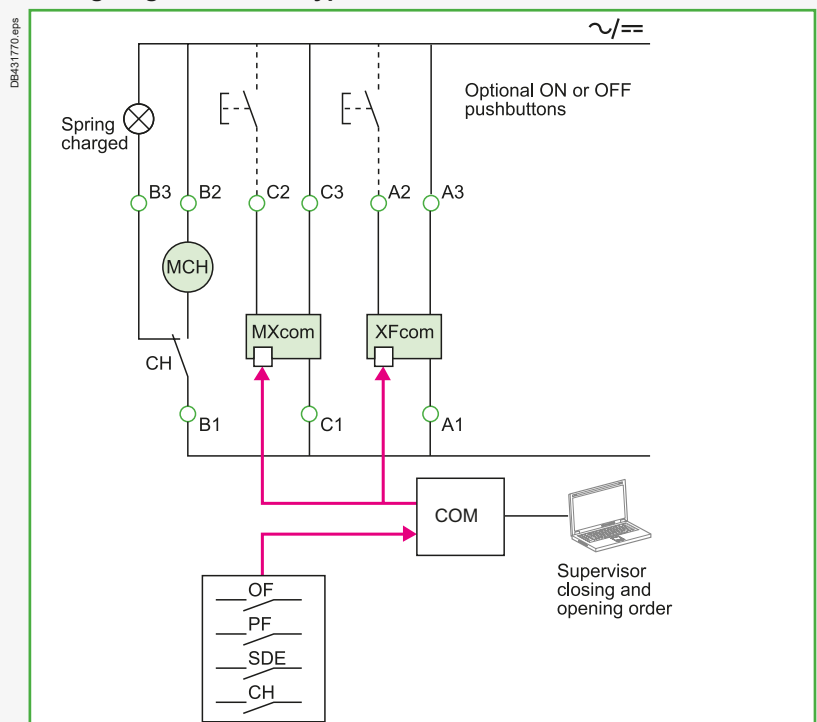

**Note:**

MX communicating releases are of the impulse type only and cannot be used to lock a circuit breaker in OFF position. For locking in OFF position, use the remote tripping function (2<sup>nd</sup> MX or MN).

When Mx or XF communicating releases are used, the third wire (C3, A3) must be connected even if the communication module is not installed. When the control voltage (C3-C1 or A3-A1) is applied to the MX or XF releases, it is necessary to wait 1.5 seconds before issuing an order. consequently, it is advised to use standrad MX or XF releases for applications such as source-changeover systems.



# Electrical and Mechanical Accessories

## MasterPact NW10 to NW40 DC

### Electric Motor MCH

The electric motor automatically charges and recharges the spring mechanism when the circuit breaker is closed. Instantaneous reclosing of the breaker is thus possible following opening. The spring-mechanism charging handle is used only as a backup if auxiliary power is absent.

The electric motor (MCH) is equipped as standard with a limit switch contact (CH) that signals the “charged” position of the mechanism (springs charged).

Characteristics	
Power supply	V AC 50/60 Hz 48/60 - 100/130 - 200/240 - 277 - 380/415 - 400/440 - 480
	V DC 24/30 - 48/60 - 100/125 - 200/250
Operating threshold	0.85 to 1.1 Un
Consumption (VA or W)	180
Motor overcurrent	2 to 3 In for 0.1 s
Charging time	maximum 4 seconds
Operating frequency	maximum 3 cycles per minute
CH contact	10 A at 240 V

### Voltage Releases XF and MX

Their supply can be maintained or automatically disconnected.

#### Closing release XF

The XF release remotely closes the circuit breaker if the spring mechanism is charged.

#### Opening release MX

The MX release instantaneously opens the circuit breaker when energized, the minimum duration of the pulse operating order must be 200 ms. The MX release locks the circuit breaker in OFF position if the order is maintained (except for MX “communicating” releases).

**Note:** Whether the operating order is maintained or automatically disconnected (pulse-type), XF or MX “communicating” releases (“bus” solution with “COM” communication option) always have an impulse-type action (see diagram).

Characteristics	XF	MX
Power supply	V AC 50/60 Hz 24 - 48 - 100/130 - 200/250 - 277 - 380/480	
	V DC 12 - 24/30 - 48/60 - 100/130 - 200/250	
Operating threshold	0.85 to 1.1 Un	0.7 to 1.1 Un
Consumption (VA or W)	pick-up: 200 (during 200 ms) hold: 4.5	pick-up: 200 (during 200 ms) hold: 4.5
Circuit breaker response time at Un	70 ms ±10 (NW DC ≤ 4000 A) 80 ms ±10 (NW DC > 4000 A)	50 ms ±10 (NW DC)

### “Ready to Close” Contact PF

The “ready to close” position of the circuit breaker is indicated by a mechanical indicator and a PF changeover contact. This signal indicates that all the following are valid:

- The circuit breaker is in the OFF position
- The spring mechanism is charged
- A maintained opening order is not present:
  - MX energized
  - Fault trip
  - Remote tripping second MX or MN
  - Device not completely racked in
  - Device locked in OFF position
  - Device interlocked with a second device.

Characteristics			
Supplied as standard	-		
Maximum number	1		
Breaking capacity p.f.: 0.3 AC12/DC12	Standard	minimum load: 100 mA/24 V	
	V AC	240/380	5
		480	5
		690	3
	V DC	24/48	3
		125	0.3
		250	0.15
	Low-level	minimum load: 2 mA/15 V	
	V AC	24/48	3
		240	3
380		3	
V DC		24/48	3
		125	0.3
		250	0.15



Electric motor MCH for MasterPact NW DC

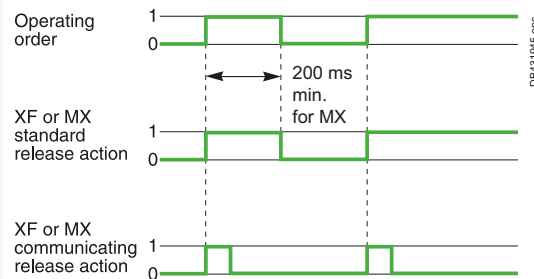

XF and MX voltage releases



“Ready to close” contacts PF

PB100808-32R.eps



DB431945.eps

PB100809-16R.eps

PB100810-16R.eps

# Electrical and Mechanical Accessories

## MasterPact NW10 to NW40 DC



### Electrical Closing Pushbutton BPFE

Located on the front panel, this pushbutton carries out electrical closing of the circuit breaker. It is generally associated with the transparent cover that avoids access to the closing pushbutton.

Electrical closing via the BPFE pushbutton takes into account all the safety functions that are part of the control/monitoring system of the installation.

The BPFE connects to the closing release XF in place of the COM module.

The COM module is incompatible with this option.

Different types of voltage exist and the XF electromagnet is compulsory if the BPFE option is selected.

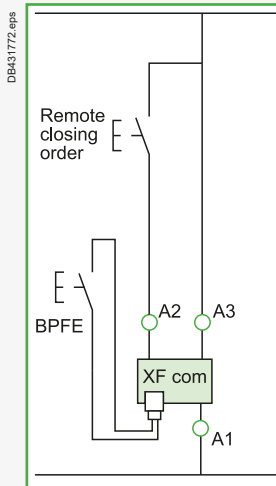

### Remote Reset After Fault Trip

#### Electrical reset after fault trip RES

Following tripping, this function resets the “fault trip” indication contacts SDE and the mechanical indicator and enables circuit breaker closing.

Power supply: 110/130 V AC and 200/240 V AC.

The use of XF closing release is compulsory with this option.

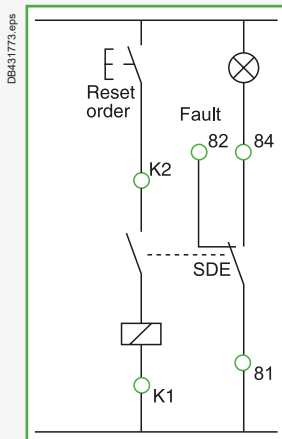

#### Automatic reset after fault trip RAR

Following tripping, a reset of the mechanical indicator (reset button) is no longer required to enable Circuit breaker closing. The mechanical (reset button) and electrical SDE indications remain in fault position until the reset button is pressed. The use of XF closing release is compulsory with this option.

# Electrical and Mechanical Accessories

## MasterPact NW10 to NW40 DC

### Remote Operation: Remote Tripping

This function opens the circuit breaker via an electrical order. It is made up of:

- A shunt release second MX
- Or an undervoltage release MN
- Or a delayed undervoltage release MNR: (MN + delay unit).

These releases (2<sup>nd</sup> MX or MN) cannot be operated by the communication bus. The delay unit, installed outside the circuit breaker, may be disabled by an emergency OFF button to obtain instantaneous opening of the circuit breaker.

#### Wiring diagram for the remote-tripping function

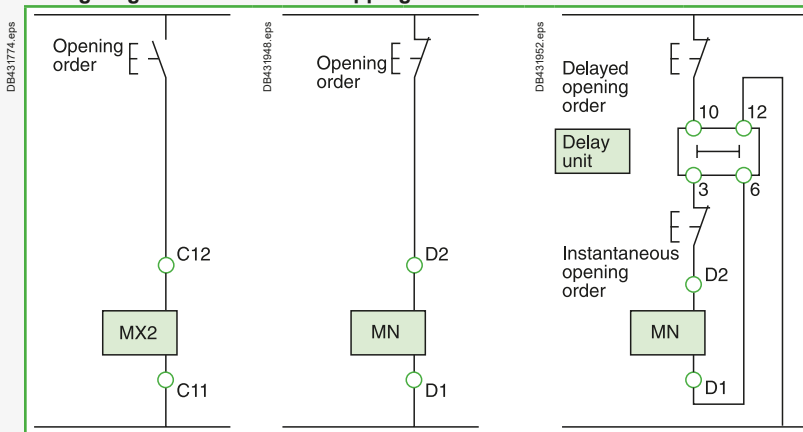

### Voltage Releases Second MX

When energized, the MX voltage release instantaneously opens the circuit breaker. A continuous supply of power to the second MX locks the circuit breaker in the OFF position.

Characteristics		
Power supply	V AC 50/60 Hz	24 - 48 - 100/130 - 200/250 - 277 - 380/480
	V DC	24/30 - 48/60 - 100/130 - 200/250
Operating threshold		0.7 to 1.1 Un
Permanent locking function		0.85 to 1.1 Un
Consumption (VA or W)		pick-up: 200 (during 80 ms)      hold: 4.5
Circuit breaker response time at Un		50 ms ±10

### Instantaneous Voltage Releases MN

The MN release instantaneously opens the circuit breaker when its supply voltage drops to a value between 35 % and 70 % of its rated voltage. If there is no supply on the release, it is impossible to close the circuit breaker, either manually or electrically. Any attempt to close the circuit breaker has no effect on the main contacts. Circuit breaker closing is enabled again when the supply voltage of the release returns to 85 % of its rated value.

Characteristics		
Power supply	V AC 50/60 Hz	24 - 48 - 100/130 - 200/250 - 380/480
	V DC	12 - 24/30 - 48/60 - 100/130 - 200/250
Operating threshold	opening	0.35 to 0.7 Un
	closing	0.85 Un
Consumption (VA or W)		pick-up: 200 (during 200 ms)      hold: 4.5
MN consumption with delay unit		pick-up: 200 (during 200 ms)      hold: 4.5
Circuit breaker response time at Un		90 ms ±5

### MN Delay Units

To eliminate Circuit breaker nuisance tripping during short voltage dips, operation of the MN release can be delayed. This function is achieved by adding an external delay unit in the MN voltage-release circuit. Two versions are available, adjustable and non-adjustable.

Characteristics		
Power supply	non-adjustable	100/130 - 200/250
VAC 50-60 Hz/DC	adjustable	48/60 - 100/130 - 200/250 - 380/480
Operating threshold	opening	0.35 to 0.7 Un
	closing	0.85 Un
Consumption of delay unit alone (VA or W)		pick-up: 200 (during 200 ms)      hold: 4.5
Circuit breaker response time at Un	non-adjustable	0.25 s
	adjustable	0.5 s - 0.9 s - 1.5 s - 3 s

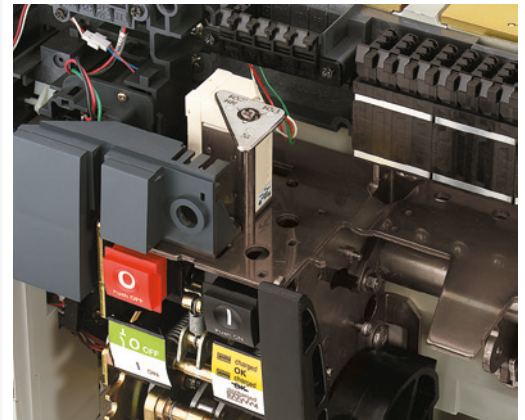

FB104580A-6BR.eps



MX or MN voltage release

FB100800-1RF.eps

# Electrical and Mechanical Accessories

## MasterPact NW10 to NW40 DC

A

DB124953.eps



### Shields, Blanking Plates, Counters

#### Auxiliary Terminal Shield CB

Optional equipment mounted on the chassis, the shield avoids access to the terminal block of the electrical auxiliaries.

PB104362-52F.eps

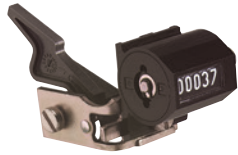

#### Operation Counter CDM

The operation counter sums the number of operating cycles and is visible on the front panel. It is compatible with manual and electrical control functions.

DB41775.eps

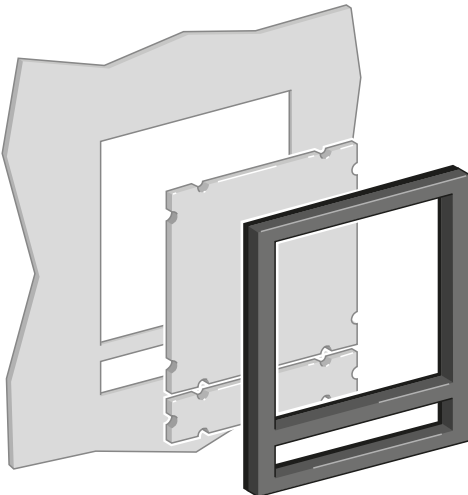

#### Escutcheon CDP

Optional equipment mounted on the door of the cubicle, the escutcheon increases the degree of protection to IP 40 (circuit breaker installed free standing: IP30) . It is available in fixed and drawout versions.

#### Blanking Plate OP for Escutcheon

Used with the escutcheon, this option closes off the door cut-out of a cubicle not yet equipped with a device. It may be used with the escutcheon for both fixed and drawout devices.

#### Transparent Cover CCP for Escutcheon

Optional equipment mounted on the escutcheon, the cover is hinged and secured by a screw. It increases the degree of protection to IP 54, IK10. It adapts to drawout devices.

Escutcheon CDP with blanking plate

PB100776-42R.eps

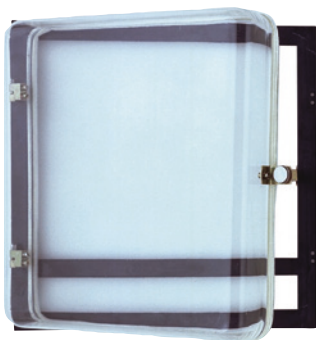

Transparent cover CCP for escutcheon

DB41776.eps

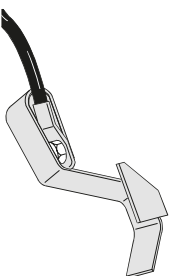

Grounding kit KMT

#### Grounding Kit KMT

This option allows the grounding of the breaker mechanism while the front cover is removed. The grounding is made via the chassis for the drawout version and via the fixation side plate for the fixed version.

# Installation Recommendations

**ComPacT NSX100 to NSX1200 DC**  
Installation in Switchboards ..... B-2  
Power Connections ..... B-3  
Safety Clearances, Minimum Distances and  
Insulation of Live Parts ..... B-5  
Temperature Derating ..... B-6  
Characteristics of Circuit Breakers with Parallel Connection  
of Poles ..... B-7

**ComPacT NSX DC PV**  
Safety Clearances and Minimum Distances ..... B-10

**ComPacT NSX NA DC PV..... B-11**  
Safety Clearances and Minimum Distances ..... B-11  
Temperature Derating ..... B-12  
Temperature Derating - Power Dissipation/Resistance..... B-13

**ComPacT NSX DC EP**  
Safety Clearances and Minimum Distances ..... B-14  
Temperature Derating ..... B-16

**MasterPact NW10 to NW40 DC, EPDC, DC PV**  
Installation in Switchboard ..... B-18  
Door Interlock ..... B-19  
Cable-Type Door Interlock - Connection of MN, MX  
and XF Voltage Releases ..... B-20  
Power Connection ..... B-21  
Busbar Sizing ..... B-24  
Temperature Derating - Power Dissipation..... B-25



**Other Chapters**  
Presentation ..... 2  
Functions and Characteristics ..... A-1  
Dimensions and Connection ..... C-1  
Electrical Diagrams ..... D-1  
Additional Characteristics ..... E-1  
Catalog Numbers and Order Form ..... F-1

# ComPacT NSX100 to NSX1200 DC Installation in Switchboards

B

## Possible Mounting Positions

For Fixed or Withdrawable Circuit Breakers

Fig. A

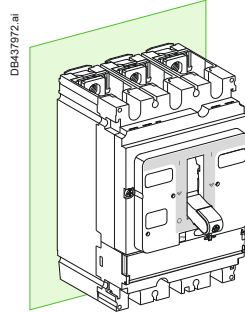

Fig. B

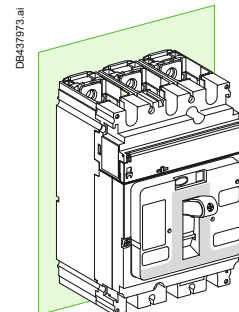

Fig. C

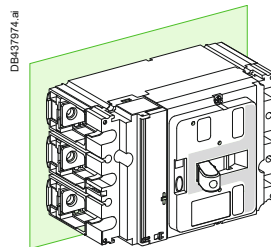

Fig. D

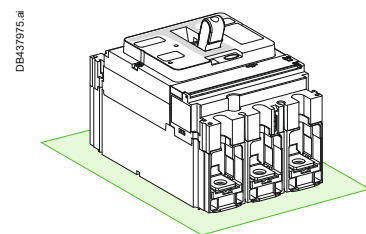
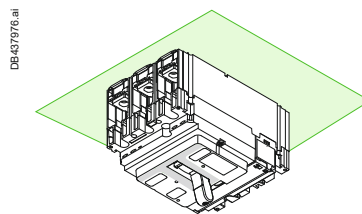

Fig. E



## Possible Supports

For Fixed or Withdrawable Circuit Breakers

On a plain mounting plate

On a slotted mounting plate

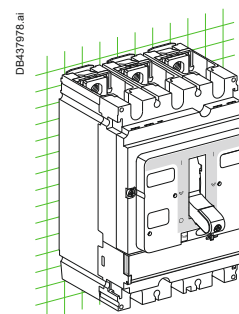
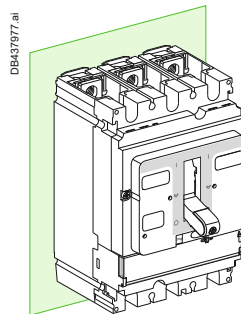

On rails

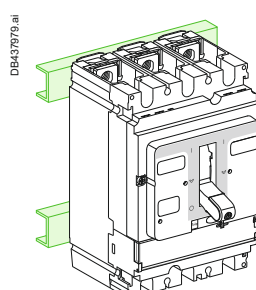



# Installation Recommendations

## ComPacT NSX100 to NSX1200 DC

### Power Connections

### Electrodynamic Forces on the Conductors

The circuit breakers can be connected with copper, tinned copper or tinned aluminum conductors (rigid or flexible bars, cables).

In the event of a short-circuit, electrodynamic forces will be exerted on the conductors.

They must therefore be correctly sized and maintained in place using supports.

Electrical connection points on all types of devices (contactors, circuit breakers, etc.) should not be used for mechanical support.

### Ties for Flexible Bars and Cables

The table below indicates the maximum distance between ties depending on the prospective short-circuit current.

The maximum distance between ties attached to the switchboard frame is 400 mm.

Type of tie	Maximum distance between ties (mm)	Short-circuit current (kA rms)
<b>“PANDUIT” type ties</b>	200	10
Width: 4.5 mm	100	14
Max. load: 22 kg	50	19
White		
<b>“SAREL” type ties</b>	350	21
Width: 9 mm	200	27
Max. load: 90 kg	100	36
Black	70	45
Double ties	50	100

**Note:** For 50 mm<sup>2</sup> cables, use the 9 mm wide ties.

### Weights

Type	Circuit breaker	Plug-in base	Chassis	Motor mechanism
<b>NSX100N/H DC</b>	1P/1D	0.5	-	-
	2P/2D	1.45	-	-
<b>NSX100 DC</b>	3P/3D	1.79	0.8	2.2
	4P/4D	2.57	1.05	2.2
<b>NSX160N/H DC</b>	1P/1D	0.5	-	-
	2P/2D	1.45	-	-
<b>NSX160N DC</b>	3P/3D	1.85	0.8	2.2
	4P/4D	2.58	1.05	2.2
<b>NSX250 DC</b>	3P/3D	2.2	0.8	2.2
	4P/4D	2.78	1.05	2.2
<b>NSX400/630 DC</b>	3P/3D	6.19	2.4	2.2
	4P/4D	8.13	2.8	2.2
<b>NSX1200 DC</b>	2P/2D	8.9	-	2.8

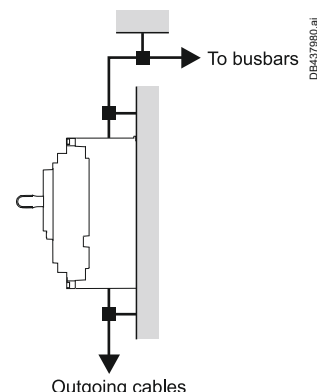

# ComPacT NSX100 to NSX1200 DC

## Power Connections

B

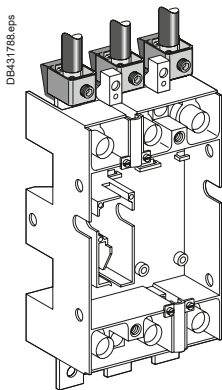
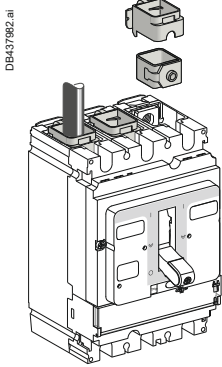
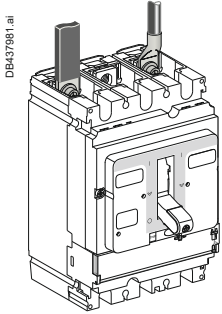

### Connection of Insulated Bars or Cables with Lugs

	NSX100/160/250 DC	NSX400/630/1200 DC	
	<b>Bars</b>		
	L (mm)	≤ 25	≤ 32
	I (mm)	d + 10	d + 15
	d (mm)	≤ 10	≤ 15
	e (mm)	≤ 6	3 ≤ e ≤ 10
	<b>Lugs</b>		
	L (mm)	≤ 25	≤ 32
	Ø (mm)	8.5	10.5
	Tightening torque (Nm) <sup>[1]</sup>	15	50
	Tightening torque (Nm) <sup>[2]</sup>	5	20

[1] Tightening torque for lugs or bars on the circuit breaker.

[2] Tightening torque for rear connections or terminal extensions on plug-in base.

### Connection of Bare Cables

#### NSX100 to 250 DC

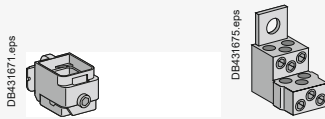

Cable connector      Distribution connector

	Cable connector	Steel		Aluminium	
		≤ 160 A	≤ 250 A	≤ 250 A	≤ 250 A
	L (mm)	20	20		
	S (mm <sup>2</sup> ) Cu/Al	1.5... 95 <sup>[1]</sup>	10... 16	25... 35	50... 185 150 max. flexible
	Tightening torque (Nm)	12	15	20	26
<b>6-cable distribution connector (copper or aluminium)</b>					
	L (mm)	15 or 30			
	S (mm <sup>2</sup> ) Cu/Al	1.5... 6 <sup>[1]</sup>	8... 35		
	Tightening torque (Nm)	4	6		

[1] For flexible cables from 1.5 to 4 mm<sup>2</sup>, connection with crimped or self-crimping ferrule.

#### NSX400 to 630 DC

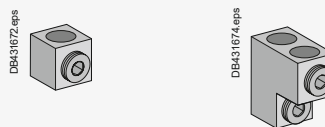

Cable connector      Distribution connector

	Cable connector	2-cable connector	
		Cable connector	2-cable connector
	L (mm)	20	30 or 60
	S (mm <sup>2</sup> ) Cu/Al	35 to 300 rigid 240 max. flexible	2 x 85 to 2 x 240 rigid 240 max. flexible
	Tightening torque (Nm)	31	31

#### NSX1200 DC

	2-cable connector	
	L (mm)	30 or 60
	S (mm <sup>2</sup> ) Cu/Al	2 x 85 to 2 x 240 rigid 240 max. flexible
	Tightening torque (Nm)	31

# ComPacT NSX100 to NSX1200 DC

## Safety Clearances, Minimum Distances and Insulation of Live Parts

When installing a ComPacT NSX100 to 1200 DC circuit breaker, minimum distances (safety clearances) must be maintained between the device and panels, bars and other protection devices installed nearby. These distances, which depend on the ultimate breaking capacity, are defined by tests carried out in accordance with standard IEC 60947-2.

If installation conformity is not checked by type tests, it is also necessary to:

- Use insulated bars for circuit breaker connections
- Block off the busbars using insulating screens.

Terminal shields, interphase barriers and the insulation kit are recommended and may be mandatory depending on the utilization voltage and the type of installation (fixed, withdrawable).

Dimensions (mm)	Insulation, insulated bars or painted sheet metal			Sheetmetal						
	C1	D1	D2	C2	D1	D2	A1 [2]	A2 [3]	B	
<b>ComPacT circuit breaker</b>										
<b>NSX100-250 DC</b>	U ≤ 250 V	0	30	30	5	35	35	0	10	0
	U ≤ 500 V	0	30	30	10 [1]	35	35	0	20	0
	U ≤ 750 V	0	30 [4]	30 [4]	20 [4]	35 [4]	35 [4]	0	-	0
<b>NSX400-630 DC</b>	U ≤ 250 V	0	30	30	5	60	60	0	10	0
	U ≤ 500 V	0	30	30	10 [1]	60	60	0	20	0
	U ≤ 750 V	0	30 [4]	30 [4]	20 [4]	100 [4]	100 [4]	0	-	0
<b>NSX1200 DC [5]</b>	U ≤ 300 V	0	30	30	10	60	60	0	-	0
	U ≤ 600 V	0	30	30	20	100	100	0	-	0

[1] Distance must be doubled with interphase barriers.

[2] For ComPacT NSX DC with long or short terminal shields.

[3] For ComPacT NSX DC without terminal shields.

[4] For voltage > 500 V, terminal shields are mandatory. The length of terminal shields (long or short terminal shields) should be considered.

[5] For ComPacT NSX1200 DC, terminal shields are required and are supplied with the circuit breaker.

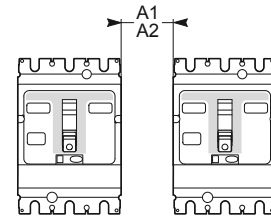

Minimal distance between two adjacent circuit breakers

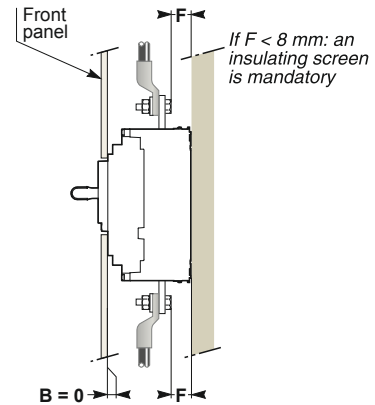

Minimal distance between the circuit breaker and front or rear panels

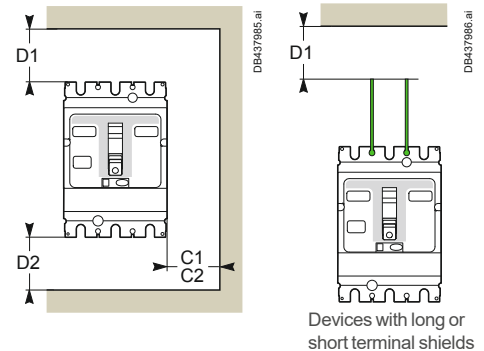

Minimal distance between the circuit breaker and top, bottom or side panels

### Terminal Shield Configuration

	NSX400/630/1200, NSX400/630 NA					NSX1200
<b>Circuit breaker construction</b>	3P	3P	4P	4P	4P	2P (4P platform)
<b>Pole connection</b>	3P in series	2P in series	3P in series	4P in series	2P parallel	-
<b>Terminal shield construction</b>	3P	3P	4P	4P	4P	4P
<b>upstream</b>	LV438291	LV432593	LV438294	LV432594	LV438293	LV438293
<b>upstream with rear connection downstream</b>	LV438291	LV432593 or LV432591 (short)	LV438295	LV432594 or LV432592 (short)	LV438293	-
	LV438291	LV438292	LV438295	LV438293	LV438293	LV438293

# ComPacT NSX100 to NSX1200 DC

## Temperature Derating

These values are valid for fixed and withdrawable circuit breakers with or without terminal shields.

- "≤ 500 V" means that 2 poles only are used, for isolated system, this table shall be used up to 250 V only.
- "> 500 V" means that 3 or 4 poles are used, for isolated system, this table shall be used up to 500 V only.

When the ambient temperature is greater than 40 °C, overload-protection characteristics are slightly modified.

To determine tripping times using time/current curves, use the values of the current indicated in the table below, corrected to take into account the ambient temperature.

### ComPacT NSX DC temperature derating

NSX DC configuration	Type of trip unit	Rating In (A) for a given temperature						
		Ambient temp. 40 °C	Ambient temp. 45 °C	Ambient temp. 50 °C	Ambient temp. 55 °C	Ambient temp. 60 °C	Ambient temp. 65 °C	Ambient temp. 70 °C
<b>NSX100 DC 1/2P</b> 1P 250 V - 2P 500 V	TM16D	16	15.6	15.2	14.8	14.5	14	13.8
	TM25D	25	24.5	24	23.5	23	22	21
	TM30D	30	31.3	30.5	30	29.5	29	28.5
	TM40D	40	39	38	37	36	35	34
	TM50D	50	49	48	47	46	45	44
	TM63D	63	61.5	60	58	57	55	54
	TM80D	80	78	76	74	72	70	68
	TM100D	100	97.5	95	92.5	90	87.5	85
<b>NSX160 DC 1/2P</b> 1P 250 V - 2P 500 V	TM125D	125	122	119	116	113	109	106
	TM160D	160	156	152	147	144	140	136
<b>NSX100 DC 3/4P ≤ 500 V</b>	TM16D	16.8	16.4	16	15.5	15.2	14.7	14.5
	TM25D	26.3	25.7	25.2	24.7	24.2	23.1	22.1
	TM32D	33.6	33	32	31.5	31	30.5	30
	TM40D	42	41	40	39	38	37	36
	TM50D	53	51	50	49	48	47	46
	TM63D	66	65	63	61	60	58	57
	TM80DC	84	82	80	78	76	74	71
	TM100DC	105	102	100	97	95	92	89
<b>NSX160 DC 3/4P ≤ 500 V</b>	TM125DC	131	128	125	122	119	114	111
	TM160DC	168	164	160	154	151	147	143
<b>NSX250 DC 3/4P ≤ 500 V</b>	TM200DC	210	205	200	194	189	184	179
	TM250DC	250	240	235	230	220	210	200
<b>NSX100 DC 3/4P &gt; 500 V</b>	TM16D	16	15.6	15.2	14.8	14.5	14	13.8
	TM25D	25	24.5	24	23.5	23	22	21
	TM32D	32	31.3	30.5	30	29.5	29	28.5
	TM40D	40	39	38	37	36	35	34
	TM50D	50	49	48	47	46	45	44
	TM63D	63	61.5	60	58	57	55	54
	TM80DC	80	78	76	74	72	70	68
	TM100DC	100	97.5	95	92.5	90	87.5	85
<b>NSX160 DC 3/4P &gt; 500 V</b>	TM125DC	125	122	119	116	113	109	106
	TM160DC	160	156	152	147	144	140	136
<b>NSX250 DC &gt; 500 V</b>	TM200DC	200	195	190	185	180	175	170
	TM250DC	230	225	220	210	200	190	180
<b>NSX400 DC ≤ 500 V</b>	TM250DC	250 A	250 A	240 A	230 A	220 A	205 A	195 A
	TM320DC	320 A	320 A	315 A	305 A	295 A	280 A	270 A
	TM400DC	400 A	400 A	395 A	380 A	370 A	355 A	340 A
<b>NSX400 DC &gt; 500 V</b>	TM250DC	250 A	250 A	240 A	230 A	220 A	205 A	195 A
	TM320DC	320 A	320 A	315 A	305 A	295 A	280 A	270 A
	TM400 DC	400 A	400 A	395 A	380 A	370 A	350 A	340 A
<b>NSX630 DC ≤ 500 V</b>	TM500DC	500 A	500 A	490 A	475 A	460 A	440 A	420 A
	TM600DC	600 A	600 A	585 A	560 A	535 A	510 A	485 A
<b>NSX630 DC &gt; 500 V</b>	TM500DC	500 A	480 A	465 A	450 A	440 A	420 A	410 A
	TM600DC	-	-	-	-	-	-	-
<b>NSX1200 DC 600 V</b>	TM630DC	630 A	610 A	590 A	570 A	550 A	520 A	500 A
	TM800DC	800 A	775 A	740 A	720 A	695 A	665 A	640 A
	TM1000DC	1000 A	970 A	930 A	905 A	870 A	830 A	800 A
	TM1200DC	1200 A	1160 A	1115 A	1085 A	1040 A	995 A	955 A
<b>NSX400 NA DC ≤ 500 V</b>		400 A	400 A	400 A	400 A	400 A	400 A	400 A
<b>NSX400 NA DC &gt; 500 V</b>		400 A	400 A	400 A	400 A	400 A	400 A	400 A
<b>NSX600 NA DC ≤ 500 V</b>		630 A	600 A	580 A	560 A	540 A	520 A	500 A
<b>NSX600 NA DC &gt; 500 V</b>		605 A	585 A	570 A	550 A	530 A	505 A	485 A

Example ■■■: ComPacT NSX100 DC equipped with a TM80DC trip unit has a rating of:

- 84 A at 40 °C
- 78 A at 55 °C.

# ComPacT NSX100 to NSX1200 DC

## Characteristics of Circuit Breakers with Parallel Connection of Poles

When poles are connected in parallel, the trip unit corresponding to the maximum circuit breaker rating is never used, for safety reasons related to temperature rise. The heating conditions are modified. The table opposite indicates the new thermal ratings that should be used for 2P, 3P and 4P circuit breakers.

Type of circuit breaker	Pole connections	Type of trip unit	Equivalent rated current <sup>[1]</sup> In (A) at 40 °C	Magnetic threshold Ii (A) ±20 %	Breaking capacity Icu (kA)		
					250 V	500 V	
<b>NSX100F DC</b>					<b>250 V</b>	<b>500 V</b>	
NSX100F DC 2-pole  See example 2 (see page A-8)	2P in parallel	TM16D	40	520	36	-	
		TM25D	63	800			
		TM30D	80	800			
		TM40D	100	1400			
		TM50D	125	1400			
		TM63D	158	1400			
		TM80D	200	1600			
NSX100F DC 3-pole	3P in parallel	TM16D	58	780	Please consult us	-	
		TM25D	90	1200			
		TM32D	115	1650			
		TM40D	144	2100			
		TM50D	180	2100			
		TM63D	227	2100			
		TM80DC	288	2400			
		TM16G	58	240			
		TM25G	90	300			
		TM40G	144	300			
		TM63G	227	450			
		TM80G	288	750			
		TM100G	360	1200			
NSX100F DC 4-pole	4P in parallel	TM16D	74	1040	Please consult us	-	
		TM25D	115	1600			
		TM32D	147	2200			
		TM40D	184	2800			
		TM50D	230	2800			
		TM63D	290	2800			
		TM80DC	368	3200			
		TM16G	74	320			
		TM25G	115	400			
		TM40G	184	400			
		TM63G	290	600			
		TM80G	368	1000			
		TM100G	460	1600			
	2 x 2P (in parallel) in series		TM16D	37	520	36	36
			TM25D	58	800		
			TM32D	74	1100		
			TM40D	46	1400		
			TM50D	115	1400		
			TM63D	145	1400		
			TM80DC	184	1600		
			TM16G	37	160		
			TM25G	58	200		
			TM40G	46	200		
TM63G	145	300					
TM80G	184	500					
TM100G	230	800					

[1] Rated current of the assembly with the indicated pole connections.

Example : a ComPacT NSX100F DC 4-pole circuit breaker with 4 poles in parallel, equipped with a TM63D trip unit:

- An equivalent rated current of 290 A
- A fixed magnetic threshold of 2800 A.

# ComPacT NSX100 to NSX1200 DC

## Characteristics of Circuit Breakers with Parallel Connection of Poles

When poles are connected in parallel, the trip unit corresponding to the maximum circuit breaker rating is never used, for safety reasons related to temperature rise. The heating conditions are modified. The table opposite indicates the new thermal ratings that should be used for 2P, 3P and 4P circuit breakers.

B

Type of circuit breaker	Pole connections	Type of trip unit	Equivalent rated current <sup>[1]</sup> I <sub>n</sub> (A) at 40 °C	Magnetic threshold I <sub>li</sub> (A) ±20 %	Breaking capacity I <sub>cu</sub> (kA)	
					250 V	500 V
<b>NSX160F DC</b>					250 V	500 V
NSX160F DC 2-pole	2P in parallel	TM125D	313	2400	36	-
NSX160F DC 3-pole	3P in parallel	TM100DC	360	2400	Please consult us	-
		TM125DC	450	3750		
		TM125G	450	1560		
		TM160G	576	1560		
NSX160F DC 4-pole	4P in parallel	TM100DC	460	3200		
		TM125DC	575	5000		
		TM125G	575	2080		
		TM160G	736	2080		
See example 1 (see page A-8)	2x2P (in parallel) in series	TM100DC	230	1600	36	36
		TM125DC	288	2500		
		TM125G	288	1040		
		TM160G	368	1040		
<b>NSX250F DC</b>						
NSX250F DC 3-pole	2P in parallel	TM160DC	400	2500	36	-
		TM200DC	500	2000 to 4000		
NSX250F DC 3-pole	3P in parallel	TM160DC	576	3750	Please consult us	-
		TM200DC	720	3000 to 6000		
		TM200G	720	1560		
		TM250G	900	1875		
NSX250F DC 4-pole	4P in parallel	TM160DC	736	5000		
		TM200DC	920	4000 to 8000		
		TM200G	920	2080		
		TM250G	1150	2500		
	2x2P (in parallel) in series	TM160DC	368	2500	36	36
		TM200DC	460	2000 to 4000		
		TM200G	460	1040		
		TM250G	575	1250		

Example ■■■: a ComPacT NSX160F DC 4-pole circuit breaker with 2x2P poles in parallel, equipped with a TM125DC trip unit:

- A equivalent rated current of 288 A
- A fixed magnetic threshold of 2500 A.



# ComPacT NSX100 to NSX1200 DC

## Characteristics of Circuit Breakers with Parallel Connection of Poles

When poles are connected in parallel, the trip unit corresponding to the maximum circuit breaker rating is never used, for safety reasons related to temperature rise. The heating conditions are modified. The table opposite indicates the new thermal ratings that should be used for 2P, 3P and 4P circuit breakers.

Type of circuit breaker	Pole connections	Type of trip unit	Equivalent rated current <sup>[1]</sup> I <sub>n</sub> (A) at 40 °C	Magnetic threshold I <sub>li</sub> (A) ±20 %	Breaking capacity I <sub>cu</sub> (kA)	
					250 V	500 V
<b>NSX400F DC</b>						
NSX400F DC 3-pole	2P in parallel	TM250DC	500	1250 to 2000	36	-
		TM320DC	640	1600 to 3200		
	3P in parallel	TM250DC	750	1875 to 3000	36	-
		TM320DC	960	2400 to 4800		
NSX400F DC 4-pole	4P in parallel	TM250DC	1000	2500 to 4000	36	36
		TM320DC	1280	3200 to 6400		
	2x2P (in parallel) in series	TM250DC	500	1250 to 2000	36	36
		TM320DC	640	1600 to 3200		
<b>NSX630F DC</b>						
NSX630F DC 3-pole	2P in parallel	TM500DC	1000	2500 to 5000	36	-
		TM600DC	1065	3000 to 6000		
NSX630F DC 3-pole	3P in parallel	TM500DC	1485	3750 to 7500	36	-
		TM600DC	1500	4500 to 9000		
NSX630F DC 4-pole	4P in parallel	TM500DC	1650	5000 to 10000	36	-
		TM600DC	1985	6000 to 12000		

B

# ComPacT NSX DC PV

## Safety Clearances and Minimum Distances

B

### Safety Clearance Using Terminals Shields

- Terminal shields must be used with all DC PV circuit breakers when operating at 1000 V DC.
- Terminal shields can be used in option with DC PV switch-disconnectors ( $U \leq 1000$  V DC).

### ComPacT NSX80 to 200 DC PV and ComPacT NSX250 to 500 DC PV

#### Minimal distance between two adjacent devices

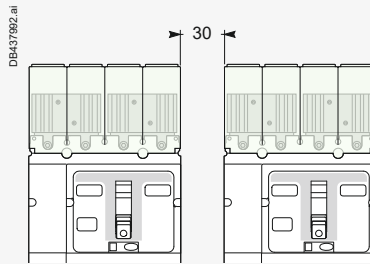

#### Minimal distance between the device and panels

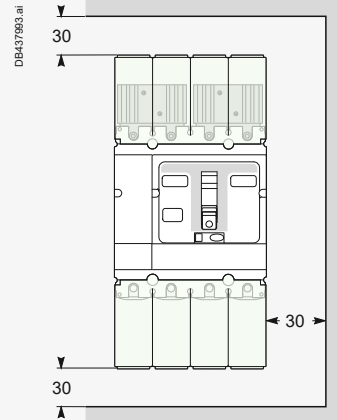

#### Minimal distance between the device and panels

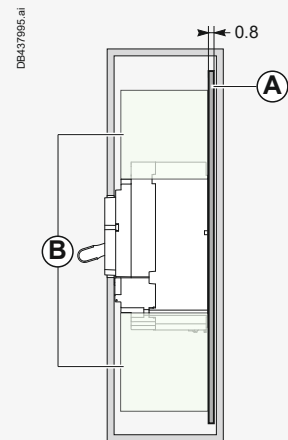
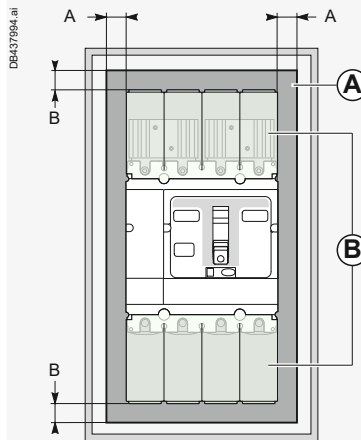

Dimensions (mm)	Insulation, insulated bars or painted sheet metal	
	A	B
NSX80-200 DC PV	13	13
NSX250 to 500 DC PV	26	26

- (A) Fiber insulating plate to be made by the customer.
- (B) Long terminal shield.

**Note:** The thermal behavior of switchgear and enclosures warrants careful monitoring. PV generator boxes and array boxes are usually installed outdoors and exposed to the elements. In the event of high ambient temperatures, high IP levels could reduce air flow and thermal power dissipation. In addition, the way switchgear devices achieve high voltage operation - i.e. through the use of poles in series - increases their temperature. Special attention should therefore be paid to the temperature of switchgear inside outdoor enclosures on the DC side. Schneider Electric recommends checking the installation as per IEC 61439 or any other equivalent standard.

# Installation Recommendations

## ComPacT NSX NA DC PV

### Safety Clearances and Minimum Distances

### Safety Clearance with Interphase Barriers

■ Interphase barriers can be used **only with DC PV switch-disconnectors** ( $U \leq 1000 \text{ V DC}$ ).

#### ComPacT NSX100 to 630 NA DC PV

**Minimal distance between two adjacent devices**

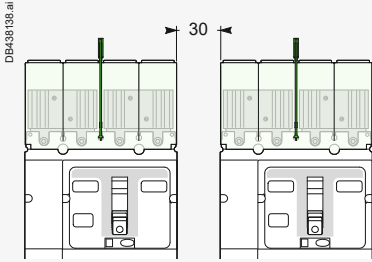

**Minimal distance between the device and panels**

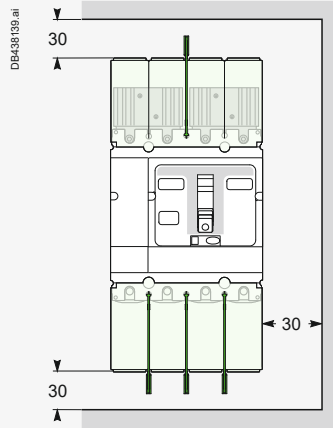

**Minimal distance between the device and panels**

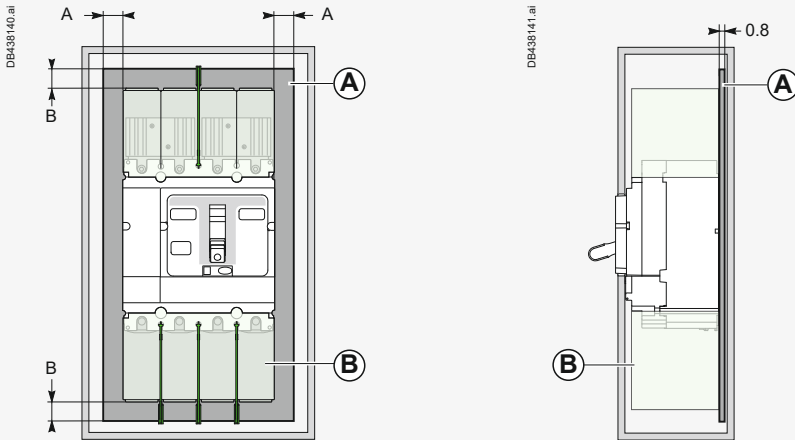

Dimensions (mm)	Insulation, insulated bars or painted sheet metal	
	A	B
NSX100 to 250 DC PV	13	13
NSX400 to 630 DC PV	26	26

- (A) Fiber insulating plate to be made by the customer.
- (B) Long terminal shield.

**Note:** The thermal behavior of switchgear and enclosures warrants careful monitoring. PV generator boxes and array boxes are usually installed outdoors and exposed to the elements. In the event of high ambient temperatures, high IP levels could reduce air flow and thermal power dissipation.

In addition, the way switchgear devices achieve high voltage operation - i.e. through the use of poles in series - increases their temperature. Special attention should therefore be paid to the temperature of switchgear inside outdoor enclosures on the DC side.

Schneider Electric recommends checking the installation as per IEC 61439 or any other equivalent standard.



ComPacT NSX200 NA DC PV with short heatsinks and interphase barriers

19\_C354250D3S.eps



ComPacT NSX200 NA DC PV with long heatsinks and interphase barriers

14\_C184630D3S.eps

# ComPacT NSX DC PV Temperature Derating

ComPacT switch-disconnectors have been tested for operation in industrial atmospheres. It is recommended that the equipment be cooled or heated to the proper operating temperature and kept free of excessive vibration and dust.

B

DC PV switch-disconnectors													
ComPacT NSX NA DC PV													
IP	Bottom interphase barrier	Bottom terminal shield	Top interphase barrier	Top terminal shield	Top series connection	Maximum current (A): I <sub>th</sub>							Cooper cable section <sup>[1]</sup>
						40 °C	45 °C	50 °C	55 °C	60 °C	65 °C	70 °C	
<b>NSX100 NA DC PV 4P</b>													
IP0	3 (LV429329)	No	1 (LV429329)	No	Short 2 x LV438328	100	100	100	100	100	100	100	Cu 35 mm <sup>2</sup>
IP4X	No	LV429518	No	LV438327	Short 2 x LV438328	100	100	100	100	100	100	100	Cu 35 mm <sup>2</sup>
<b>NSX160 NA DC PV 4P</b>													
IP0	3 (LV429329)	No	1 (LV429329)	No	Short 2 x LV438328	160	160	160	160	160	155	145	Cu 70 mm <sup>2</sup>
IP0	3 (LV429329)	No	1 (LV429329)	No	Long 2 x LV438339	160	160	160	160	160	160	160	Cu 70 mm <sup>2</sup>
IP4X	No	LV429518	No	LV438327	Short 2 x LV438328	160	160	160	160	150	145	135	Cu 70 mm <sup>2</sup>
<b>NSX200 NA DC PV 4P</b>													
IP0	3 (LV429329)	No	1 (LV429329)	No	Short 2 x LV438328	200	195	190	180	170	160	150	Cu 95 mm <sup>2</sup>
IP0	3 (LV429329)	No	1 (LV429329)	No	Long 2 x LV438339	200	200	200	200	195	185	170	Cu 95 mm <sup>2</sup>
IP4X	No	LV429518	No	LV438327	Short 2 x LV438328	190	180	175	165	155	150	140	Cu 95 mm <sup>2</sup>
<b>NSX400 NA DC PV 4P</b>													
IP3X	No	LV432594	No	LV438337	LV438338	400	400	400	400	400	390	380	Cu 240 mm <sup>2</sup>
IP0	3 (LV432570)	No	1 (LV429329)	No	LV438338	400	400	400	400	400	400	400	Cu 240 mm <sup>2</sup>
<b>NSX500 NA DC PV 4P</b>													
IP3X	No	LV432594	No	LV438337	LV438338	500	500	490	470	450	435	420	Cu 2 x 150 mm <sup>2</sup>
IP0	3 (LV432570)	No	1 (LV429329)	No	LV438338	500	500	500	500	500	500	480	Cu 2 x 150 mm <sup>2</sup>

For ComPacT NSX the overload protection is calibrated at 40 °C and for C60 DC PV at 20 °C. This means that when the ambient temperature is less or greater than these temperatures, the Ir protection pickup is slightly modified.

- Temperature rise for ComPacT range have been checked with terminal shields (mandatory) heatsink on top, four cables on bottom connections with section and length according to IEC60947-1 Table 9 and 10.
- Values in the tables are provided for vertical mounting only. In case of horizontal mounting consult us. To obtain the tripping time for a given temperature:
  - See the tripping curves for 20 or 40 °C
  - Determine tripping times corresponding to the Ir value (thermal setting on the device), corrected for the breaker ambient temperature as indicated in the tables below.

DC PV overcurrent protection												
ComPacT NSX TM DC PV												
Maximum current (A): I <sub>th</sub>											Cooper cable section <sup>[1]</sup>	
	20 °C	25 °C	30 °C	35 °C	40 °C	45 °C	50 °C	55 °C	60 °C	65 °C		70 °C
<b>NSX80 TM DC PV</b>												
88	86	84	82	80	77	75	72	69	66	63		Cu 25 mm <sup>2</sup>
<b>NSX125 TM DC PV</b>												
137.5	135	131	128	125	121	116	112	108	103	98		Cu 50 mm <sup>2</sup>
<b>NSX160 TM DC PV</b>												
176	172	168	164	160	153	147	142	136	130	124		Cu 70 mm <sup>2</sup>
<b>NSX200 TM DC PV</b>												
194	189	183	178	172	167	161	155	149	142	136		Cu 95 mm <sup>2</sup>
200	200	200	200	200	188	182	175	168	160	153		Cu 95 mm <sup>2</sup> <sup>[2]</sup>
<b>NSX250 TM DC PV</b>												
302	295	288	280	250	243	235	228	220	210	197		Cu 120 mm <sup>2</sup>
<b>NSX320 TM DC PV</b>												
371	362	352	342	320	309	297	286	273	261	248		Cu 185 mm <sup>2</sup>
<b>NSX400 TM DC PV</b>												
455	444	433	421	400	386	372	358	343	327	311		Cu 240 mm <sup>2</sup>
<b>NSX500 TM DC PV</b>												
557	542	526	511	495	478	461	444	426	405	384		Cu 2x150 mm <sup>2</sup>

[1] Temperature rise have been checked with four cables on bottom connections with section and length according to IEC60947-1 Table 9.

a. When used in array boxes, with short connection to string protections the cross section of the bars or cables shall have a higher cross section.

b. When cables have a cross section lower than the value indicated an additional 0.9 derating coefficient shall be applied. Values in the tables are provided for vertical mounting only.

[2] Take into account this derating line for products with date code over --15011.

# ComPacT NSX DC PV Temperature Derating - Power Dissipation/Resistance

## ComPacT NSX630b to 1600 DC PV Switch-Disconnectors [1]

All the given values come from connections tests.

For other kind of connections (rear horizontal/rear vertical) the values remain the same.

### DC PV switch-disconnector

#### ComPacT NSX NA DC PV

IP	Bottom interphase barrier	Bottom terminal shield	Top interphase barrier	Top terminal shield	Top series connection	Maximum current (A): I <sub>th</sub>							Copper cable section
						40 °C	45 °C	50 °C	55 °C	60 °C	65 °C	70 °C	
<b>NSX630b NA DC PV 4P</b>													
IP2X	No	33629	No	LV438968	2 x LV438966	630	630	630	630	630	630	630	Cu 2 x 185 mm <sup>2</sup>
IPO	3 (33646)	No	1 (33646)	No	2 x LV438966	630	630	630	630	630	630	630	Cu 2 x 185 mm <sup>2</sup>
<b>NSX800 NA DC PV 4P</b>													
IP2X	No	33629	No	LV438968	2 x LV438966	800	800	800	800	800	800	800	Cu 2 x 240 mm <sup>2</sup>
IPO	3 (33646)	No	1 (33646)	No	2 x LV438966	800	800	800	800	800	800	800	Cu 2 x 240 mm <sup>2</sup>
<b>NSX1000 NA DC PV 4P</b>													
IP2X	No	33629	No	LV438968	2 x LV438966	1000	1000	1000	1000	1000	1000	1000	Bar Cu 2 x 60 x 5 mm
IPO	3 (33646)	No	1 (33646)	No	2 x LV438966	1000	1000	1000	1000	1000	1000	1000	Bar Cu 2 x 60 x 5 mm
<b>NSX1250 NA DC PV 4P</b>													
IP2X	No	33629	No	LV438968	2 x LV438966	1250	1250	1250	1250	1232	1169	1102	Bar Cu 2 x 80 x 5 mm
IPO	3 (33646)	No	1 (33646)	No	2 x LV438966	1250	1250	1250	1250	1250	1227	1157	Bar Cu 2 x 80 x 5 mm
<b>NSX1600 NA DC PV 4P</b>													
IP2X	No	33629	No	LV438968	2 x LV438966	1473	1428	1384	1338	1291	1243	1193	Bar Cu 2 x 100 x 5 mm
IPO	3 (33646)	No	1 (33646)	No	2 x LV438966	1500	1500	1500	1448	1397	1345	1291	Bar Cu 2 x 100 x 5 mm

[1] For a switch-disconnector mounted in horizontal position, the derating to be applied is equivalent to that of a front or horizontal rear connected switch-disconnector.

The values indicated in the tables opposite are typical values.

#### Power dissipated per pole (P/pole) in Watts (W)

The value indicated in the table is the power dissipated at I<sub>N</sub>, four-pole switchboard (these values can be higher than the power calculated on the basis of the pole resistance). Measurement and calculation of the dissipated power are carried out in compliance with the recommendations of Annex G of standard IEC 60947-2.

#### Resistance per pole (R/pole) in milliohms (mΩ)

The value of the resistance per pole is provided as a general indication for a new device.

The value of the contact resistance must be determined on the basis of the measured voltage drop, in accordance with the manufacturer's test procedure.

### ComPacT NSX80 TM to 500 TM DC PV switch-disconnectors

Version	Fixed device TM	
	R/pole	P/pole
NSX80 TM DC PV	1	6.40
NSX100 TM DC PV	0.72	7.20
NSX125 TM DC PV	0.68	10.63
NSX160 TM DC PV	0.49	12.54
NSX200 TM DC PV	0.44	17.60
NSX250 TM DC PV	0.33	20.63
NSX320 TM DC PV	0.215	22.02
NSX400 TM DC PV	0.16	25.60
NSX500 TM DC PV	0.134	33.50

### ComPacT NSX630b NA to 1600 NA DC PV switch-disconnectors

Version	Fixed device NA	
	R/pole	P/pole
NSX630b NA DC PV	0.029	11.4
NSX800 NA DC PV	0.029	18.7
NSX1000 NA DC PV	0.030	29.7
NSX1250 NA DC PV	0.030	47.3
NSX1600 NA DC PV	0.033	74.0

**Note:** This measurement is not sufficient to determine the quality of the contacts, i.e. the capacity of the circuit breaker to carry its rated current.



# ComPacT NSX DC EP

## Safety Clearances and Minimum Distances

B

### Safety Clearance Using Terminals Shields

- Terminal shields must be used with all DC EP circuit breakers when operating at 1500 V DC.
- Terminal shields can be used in option with DC EP switch-disconnectors ( $U \leq 1500$  V DC).

#### Minimal distance between two adjacent devices (ComPacT NSX250 TM DC EP and ComPacT NSX250 NA DC EP)

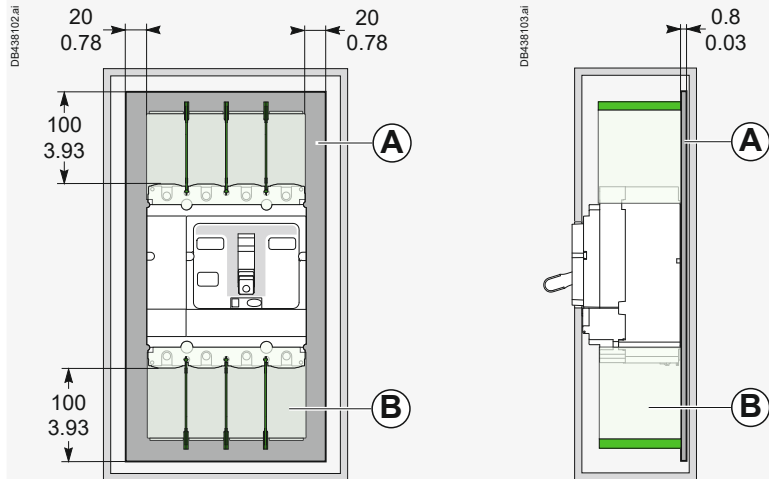

- (A) Insulating screen (LV429331) or fiber insulating plate to be made by the customer.
- (B) Interphase barriers (LV429329) or terminal shield.



# Installation Recommendations

## ComPacT NSX DC EP

### Safety Clearances and Minimum Distances

**Minimal distance between two adjacent devices  
(ComPacT NSX500 TM DC EP and ComPacT NSX630 NA DC EP)**

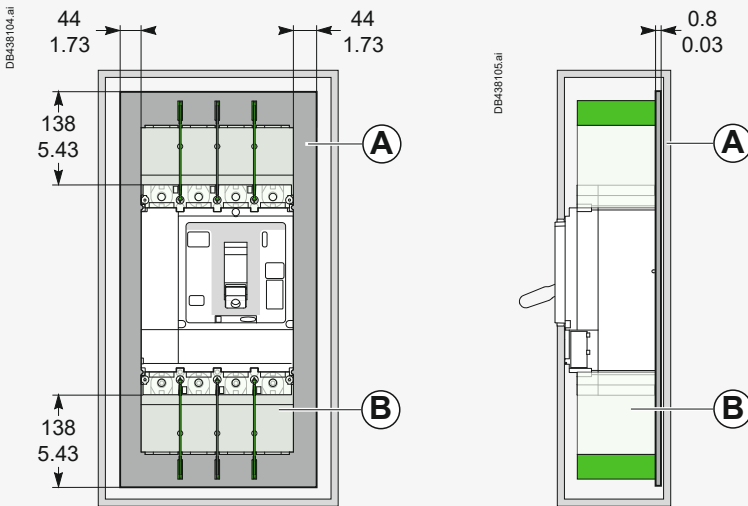

- (A) Insulating screen (LV432579) or fiber insulating plate to be made by the customer.
- (B) Interphase barriers (LV432570) or terminal shield.

**Note:**

The device must be installed in an IP5x enclosure. The thermal behavior of switchgear and enclosures warrants careful monitoring. PV generator boxes and array boxes are usually installed outdoors and exposed to the elements. In the event of high ambient temperatures, high IP levels could reduce air flow and thermal power dissipation. In addition, the way switchgear devices achieve high voltage operation - i.e. through the use of poles in series - increases their temperature. Special attention should therefore be paid to the temperature of switchgear inside outdoor enclosures on the DC side. Schneider Electric recommends checking the installation as per IEC 61439 or any other equivalent standard.



# ComPacT NSX DC EP

## Temperature Derating

ComPacT switch-disconnectors have been tested for operation in industrial atmospheres. It is recommended that the equipment be cooled or heated to the proper operating temperature and kept free of excessive vibration and dust.

### DC EP switch-disconnectors

#### ComPacT NSX NA DC EP

IP	Bottom interphase barrier	Bottom terminal shield	Top interphase barrier	Top terminal shield	Top series connection	Maximum current (A): I <sub>th</sub>							Cooper cable section <sup>(1)</sup>
						40 °C	45 °C	50 °C	55 °C	60 °C	65 °C	70 °C	

#### NSX250 NA DC EP

##### NSX100 NA DC EP 4P

IP0	3 (LV429329)	No	1 (LV429329)	No	Short 2 x LV438328	100	100	100	100	100	100	100	Cu 35 mm <sup>2</sup>
IP4X	No	LV429518	No	LV438327	Short 2 x LV438328	100	100	100	100	100	100	100	Cu 35 mm <sup>2</sup>

##### NSX160 NA DC EP 4P

IP0	3 (LV429329)	No	1 (LV429329)	No	Short 2 x LV438328	160	160	160	160	160	155	145	Cu 70 mm <sup>2</sup>
IP4X	No	LV429518	No	LV438327	Short 2 x LV438328	160	160	160	160	150	145	135	Cu 70 mm <sup>2</sup>

##### NSX200 NA DC EP 4P

IP0	3 (LV429329)	No	1 (LV429329)	No	Short 2 x LV438328	200	195	190	180	170	160	150	Cu 95 mm <sup>2</sup>
IP4X	No	LV429518	No	LV438327	Short 2 x LV438328	190	180	175	165	155	150	140	Cu 95 mm <sup>2</sup>
IP0	3 (LV429329)	No	1 (LV429329)	No	Cable	200	200	200	200	200	200	200	Cu 95 mm <sup>2</sup>

##### NSX250 NA DC EP 4P

IP0	3 (LV429329)	No	1 (LV429329)	No	Short 2 x LV438328	200	195	190	180	170	160	150	Cu 120 mm <sup>2</sup>
IP4X	No	LV429518	No	LV438327	Short 2 x LV438328	190	180	175	175	155	150	140	Cu 120 mm <sup>2</sup>
IP0	3 (LV429329)	No	1 (LV429329)	No	Cable	250	250	250	235	230	220	210	Cu 120 mm <sup>2</sup>

#### NSX630 NA DC EP

##### NSX320 NA DC EP 4P

IP3X	No	LV432594	No	LV438337	LV438338	320	320	320	320	320	320	320	Cu 185 mm <sup>2</sup>
IP0	3 (LV432570)	No	1 (LV429329)	No	LV438338	320	320	320	320	320	320	320	Cu 185 mm <sup>2</sup>

##### NSX400 NA DC EP 4P

IP3X	No	LV432594	No	LV438337	LV438338	400	400	400	400	400	390	380	Cu 240 mm <sup>2</sup>
IP0	3 (LV432570)	No	1 (LV429329)	No	LV438338	400	400	400	400	400	400	400	Cu 240 mm <sup>2</sup>

##### NSX500 NA DC EP 4P

IP3X	No	LV432594	No	LV438337	LV438338	500	500	490	470	450	435	420	Cu 2 x 150 mm <sup>2</sup>
IP0	3 (LV432570)	No	1 (LV429329)	No	LV438338	500	500	500	500	500	500	480	Cu 2 x 150 mm <sup>2</sup>

##### NSX630 NA DC EP 4P

IP3X	No	LV432594	No	LV438337	LV438338	500	500	490	470	450	435	420	Cu 2 x 185 mm <sup>2</sup>
IP0	3 (LV432570)	No	1 (LV429329)	No	LV438338	500	500	500	500	500	500	480	Cu 2 x 185 mm <sup>2</sup>
IP0	3 (LV432570)	No	1 (LV429329)	No	Cable	630	610	590	570	550	530	510	Cu 2 x 185 mm <sup>2</sup>

[1] Temperature rise have been checked with four cables on bottom connections with section and length according to IEC60947-1 Table 9 and 10.

a. When used in array boxes, with short connection to string protections the cross section of the bars or cables shall have a higher cross section.

b. When cables have a cross section lower than the value indicated an additional 0.9 derating coefficient shall be applied.

Values in the tables are provided for vertical mounting only.

## ComPacT NSX100 to 500 DC EP Overcurrent Protection <sup>[1]</sup>

DC EP overcurrent protection											
ComPacT NSX TM DC EP											
Maximum current (A): I <sub>th</sub>											Cooper cable section <sup>[2]</sup>
20 °C	25 °C	30 °C	35 °C	40 °C	45 °C	50 °C	55 °C	60 °C	65 °C	70 °C	
<b>NSX250 DC EP</b>											
<b>NSX100 TM DC EP</b>											
110	108	107	105	104	102	100	95	89	84	78	Cu 35 mm <sup>2</sup>
<b>NSX125 TM DC EP</b>											
137	135	133	131	129	127	125	119	112	105	98	Cu 50 mm <sup>2</sup>
<b>NSX160 TM DC EP</b>											
176	174	172	169	166	163	160	151	142	133	124	Cu 70 mm <sup>2</sup>
<b>NSX200 TM DC EP</b>											
225	221	217	213	209	205	200	189	177	165	153	Cu 95 mm <sup>2</sup> <sup>[2]</sup>
<b>NSX250 TM DC EP</b>											
262	260	258	256	254	252	250	238	226	213	200	Cu 120 mm <sup>2</sup>
<b>NSX500 DC EP</b>											
<b>NSX250 TM DC EP</b>											
302	294	286	277	268	259	250	237	224	211	197	Cu 120 mm <sup>2</sup>
<b>NSX320 TM DC EP</b>											
371	363	355	347	338	329	320	302	284	266	248	Cu 185 mm <sup>2</sup>
<b>NSX400 TM DC EP</b>											
455	446	437	428	419	410	400	378	356	334	311	Cu 240 mm <sup>2</sup>
<b>NSX500 TM DC EP</b>											
557	548	539	530	520	510	500	471	442	413	384	Cu 2x150 mm <sup>2</sup>

For ComPacT NSX the overload protection is calibrated at 40 °C or 50 °C. This means that when the ambient temperature is less or greater than these temperatures, the I<sub>r</sub> protection pickup is slightly modified.

- calibrated at 40 °C: heatsink on bottom & four cables on top, with terminal shields
- calibrated at 50 °C: standard cable with phase barrier connections with section and length according to IEC60947-1 Table 9 and 10.

**[1]** Values in the table are provided for standard cable with phase barrier configuration

- See the tripping curves for 50 °C.

- Determine tripping times corresponding to the I<sub>r</sub> value (thermal setting on the device), corrected for the breaker ambient temperature as indicated in the tables below

- For heatsink on bottom & four cables on top, with terminal shield. I<sub>r</sub> value is always equal I<sub>n</sub> when ambient temperature ≤ 40 °C; in case of ambient temperature > 40 °C; consult us.

**[2]** Temperature rise have been checked with cables that section and length according IEC60947-1 Table 9 and 10.

The values indicated in the tables opposite are typical values.

### Power dissipated per pole (P/pole) in Watts (W)

The value indicated in the table is the power dissipated at I<sub>N</sub>, four-pole switchboard (these values can be higher than the power calculated on the basis of the pole resistance). Measurement and calculation of the dissipated power are carried out in compliance with the recommendations of Annex G of standard IEC 60947-2.

### Resistance per pole (R/pole) in milliohms (mΩ)

The value of the resistance per pole is provided as a general indication for a new device.

The value of the contact resistance must be determined on the basis of the measured voltage drop, in accordance with the manufacturer's test procedure.

ComPacT NSX100 to 500 TM DC EP switch-disconnectors		
Version	Fixed device	
	TM R/pole	P/pole
<b>NSX250 DC EP</b>		
NSX100 TM DC EP	0.72	7.20
NSX125 TM DC EP	0.68	10.63
NSX160 TM DC EP	0.49	12.54
NSX200 TM DC EP	0.44	17.60
NSX250 TM DC EP	0.44	17.60
<b>NSX500 DC EP</b>		
NSX250 TM DC EP	0.33	20.63
NSX320 TM DC EP	0.215	22.02
NSX400 TM DC EP	0.16	25.60
NSX500 TM DC EP	0.134	33.50

**Note:** This measurement is not sufficient to determine the quality of the contacts, i.e. the capacity of the circuit breaker to carry its rated current.



# MasterPact NW10 to NW40 DC, EPDC, DC PV Installation in Switchboard

B

## Possible Positions

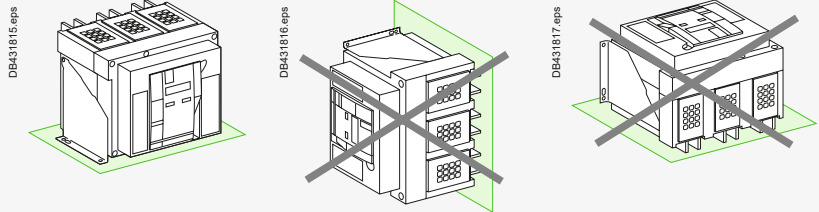

## Power Supply

The plus and minus polarities (**LINE + and LINE -**) of the power supply must be connected as indicated in the “Dimensions and connection” chapter.

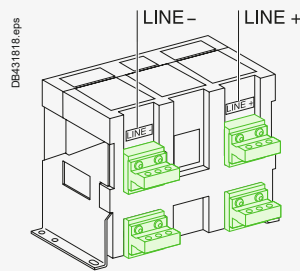

## Mounting the Circuit Breaker

It is important to distribute the weight of the device uniformly over a rigid mounting surface such as rails or a base plate. This mounting plane should be perfectly flat (tolerance on support flatness: 2 mm). This eliminates any risk of deformation which could interfere with correct operation of the circuit breaker. MasterPact devices can also be mounted on a vertical plane using the special brackets.

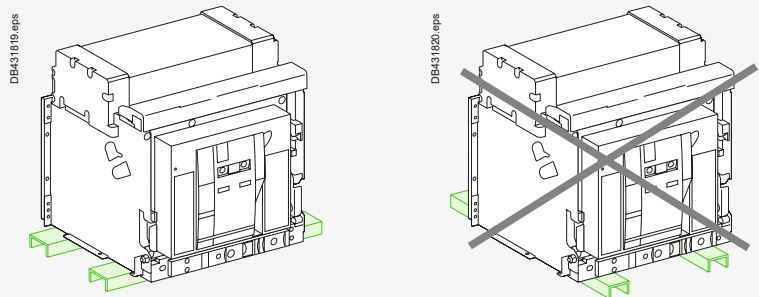

Mounting on rails

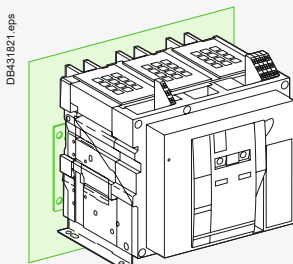

Mounting with vertical brackets

# MasterPact NW10 to NW40 DC, EPDC, DC PV Door Interlock

Mounted on the right or left-hand side of the cradle, this device inhibits opening of the cubicle door when the circuit breaker is in "connected" or "test" position. If the breaker is put in the "connected" position with the door open, the door may be closed without having to disconnect the circuit breaker.

## Door Interlock Catch VPEC

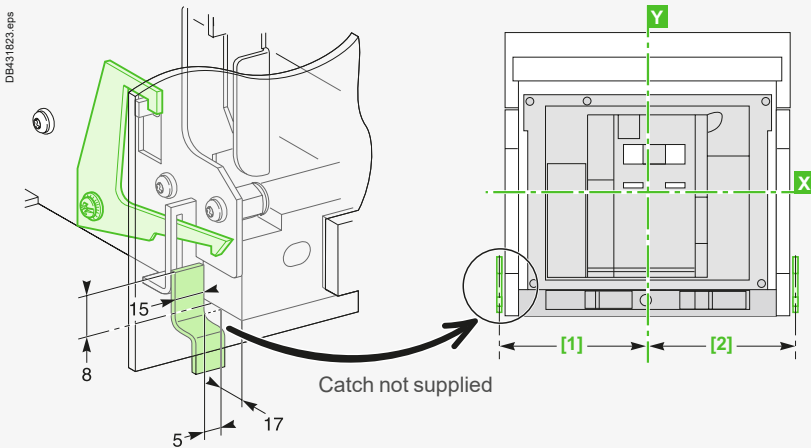

### Dimensions (mm)

Type DC	[1]	[2]
NW10-40 DC (versions C-D)	215	215
NW10-40 DC (version E)	330	215
Type DC PV	[1]	[2]
NW10-40 DC PV (version D)	215	215

## Breaker in "Connected" or "Test" Position

Door Cannot Be Opened

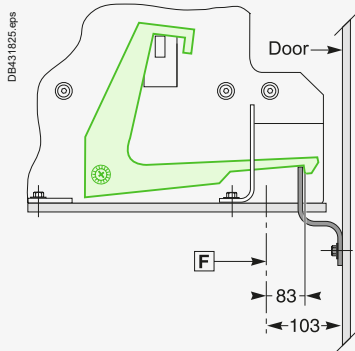

## Breaker in "Disconnected" Position

Door Can Be Opened

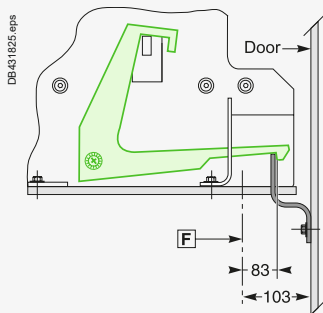

**Note:** The door interlock can either be mounted on the right side or the left side of the breaker.

**F:** Datum

B

# MasterPact NW10 to NW40 DC, EPDC, DC PV Cable-Type Door Interlock - Connection of MN, MX and XF Voltage Releases

## Cable-Type Door Interlock IPA

This option avoids door opening when the circuit breaker is closed and avoids circuit breaker closing when the door is open.

For this, a special plate associated with a lock and a cable is mounted on the right side of the circuit breaker. With this interlock installed, the source changeover function cannot be implemented.

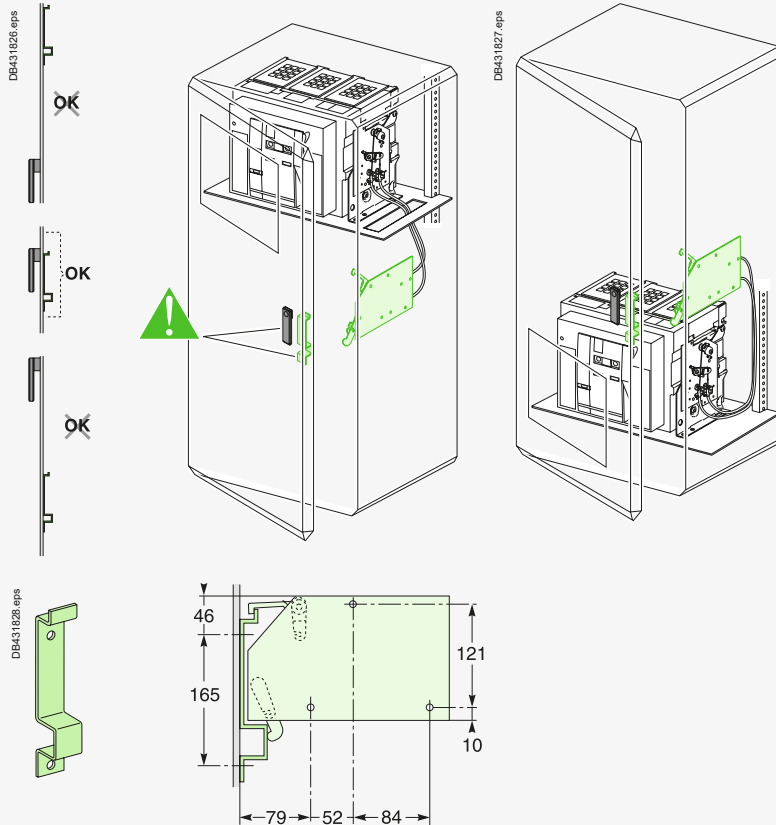

## Wiring of Voltage Releases

During pick-up, the power consumed is approximately 150 to 200 VA. For low control voltages (12, 24, 48 V), maximum cable lengths are imposed by the voltage and the cross-sectional area of cables.

### Recommended Maximum Cable Lengths (Meter)

		12 V		24 V		48 V	
		2.5 mm <sup>2</sup>	1.5 mm <sup>2</sup>	2.5 mm <sup>2</sup>	1.5 mm <sup>2</sup>	2.5 mm <sup>2</sup>	1.5 mm <sup>2</sup>
<b>MN</b>	U source 100 %	-	-	58	35	280	165
	U source 85 %	-	-	16	10	75	45
<b>MX-XF</b>	U source 100 %	21	12	115	70	550	330
	U source 85 %	10	6	75	44	350	210

**Note:** The indicated length is that of each of the two wires.

B



# MasterPact NW10 to NW40 DC, EPDC, DC PV Power Connection

## Cable Connections

If cables are used for the power connections, make sure that they do not apply excessive mechanical forces to the circuit breaker terminals.

For this, make the connections as follows:

- Extend the circuit breaker terminals using short bars designed and installed according to the recommendations for bar-type power connections:
  - For a single cable, use solution **B** opposite
  - For multiple cables, use solution **C** opposite.
- In all cases, follow the general rules for connections to busbars:
  - Position the cable lugs before inserting the bolts
  - The cables should firmly tightened to the framework of the switchboard **E**.

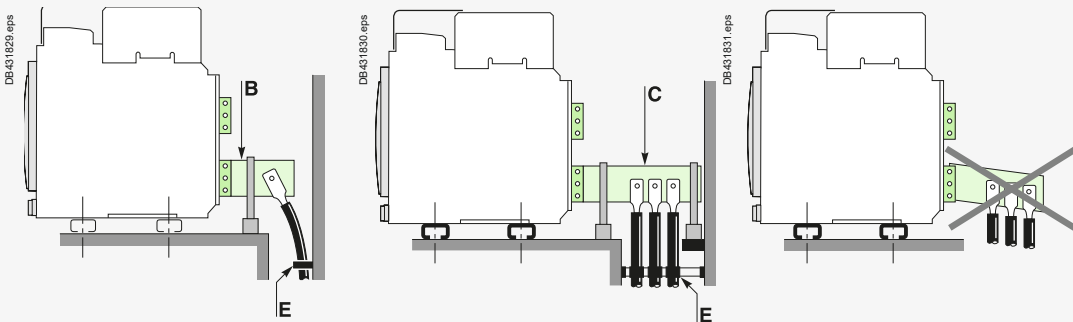

## Busbar Connections

The busbars should be suitably adjusted to ensure that the connection points are positioned on the terminals before the bolts are inserted **B**. The connections are held by the support which is solidly fixed to the framework of the switchboard, such that the circuit breaker terminals do not have to support its weight **C**. (This support should be placed close to the terminals).

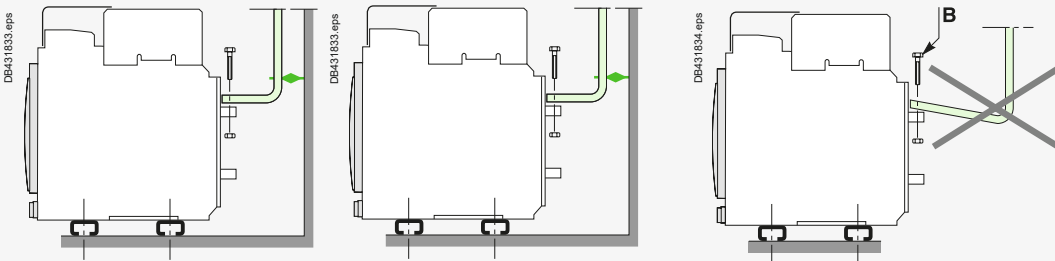

## Electrodynamic Stresses

The first busbar support or spacer shall be situated within a maximum distance from the connection point of the breaker (see table below). This distance must be respected so that the connection can withstand the electrodynamic stresses between phases in the event of a short circuit.

Maximum distance A between busbar to circuit breaker connection and the first busbar support or spacer with respect to the value of the prospective short-circuit current.					
Isc (kA)	30	50	65	80	100
distance A (mm)	350	300	250	150	150

B

# MasterPact NW10 to NW40 DC, EPDC, DC PV Power Connection

B

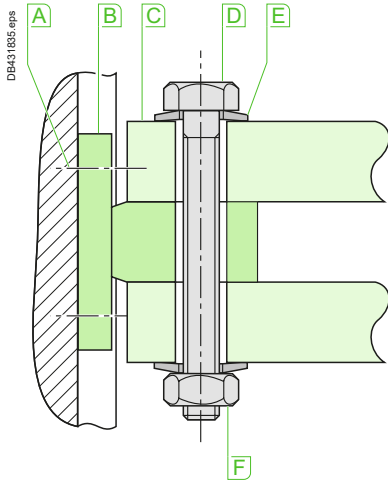

- A** Terminal screw factory-tightened to 16 Nm
- B** Breaker terminal
- C** Busbar
- D** Bolt
- E** Washer
- F** Nut

## Clamping

Correct clamping of busbars depends amongst other things, on the tightening torques used for the nuts and bolts. Over-tightening may have the same consequences as under-tightening. For connecting busbars (Cu ETP-NFA51-100) to the circuit breaker, the tightening torques to be used are shown in the table below. These values are for use with copper busbars and steel nuts and bolts, class 8.8. The same torques can be used with AGS-T52 quality aluminium bars (French standard NFA 02-104 or American National Standard H-35-1).

## Examples

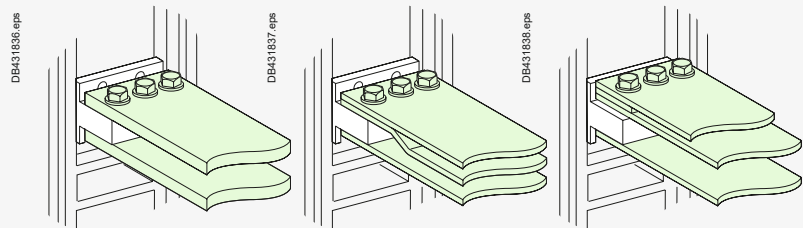

## Tightening torques

Ø Nominal (mm)	Ø Drilling (mm)	Tightening torque (Nm) with flat washers or split lockwashers	Tightening torque (Nm) with contact or serrated washers
10	11	37.5	50

## Busbar Drilling

### Examples

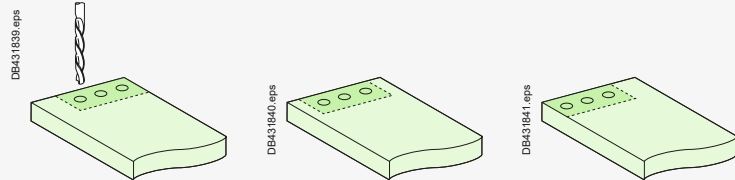

## Isolation Distance

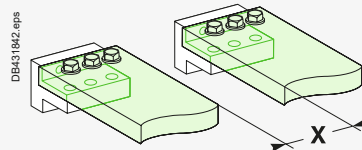

## Dimensions (mm)

Ui	X mini
500 V DC	8 mm
900 V DC	14 mm

## Busbar Bending

When bending busbars maintain the radius indicated below (a smaller radius would cause cracks).

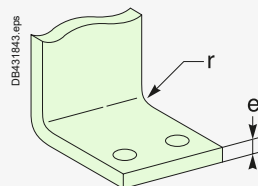

## Dimensions (mm)

e	Radius of curvature r	
	Min.	Recommended
5	5	7.5
10	15	18 to 20

# MasterPact NW10 to NW40 DC, EPDC, DC PV Power Connection

B

## Horizontal Rear Connection NW10 to NW20 DC - DC PV

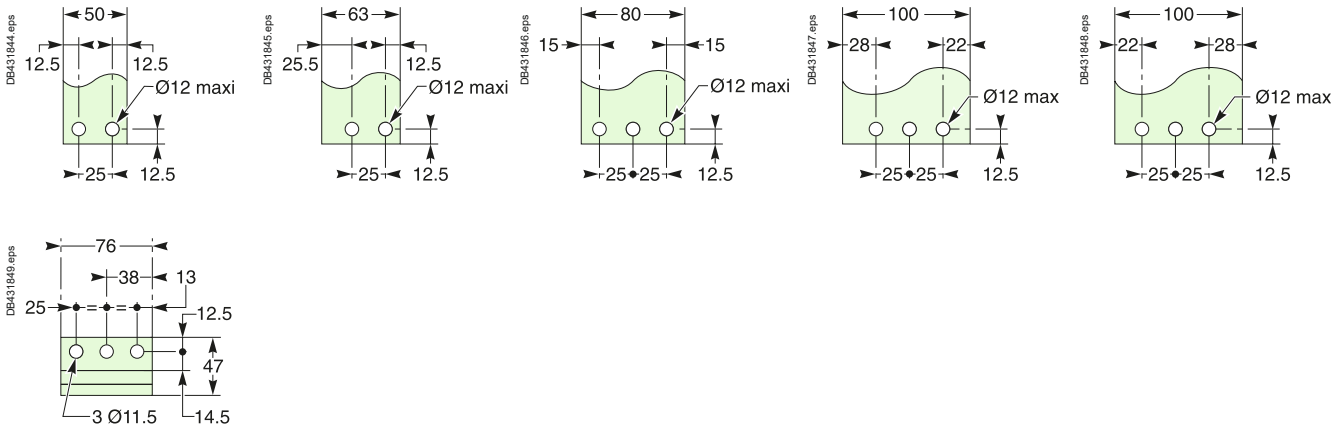

## Vertical Rear Connection NW10 to NW20 DC - DC PV

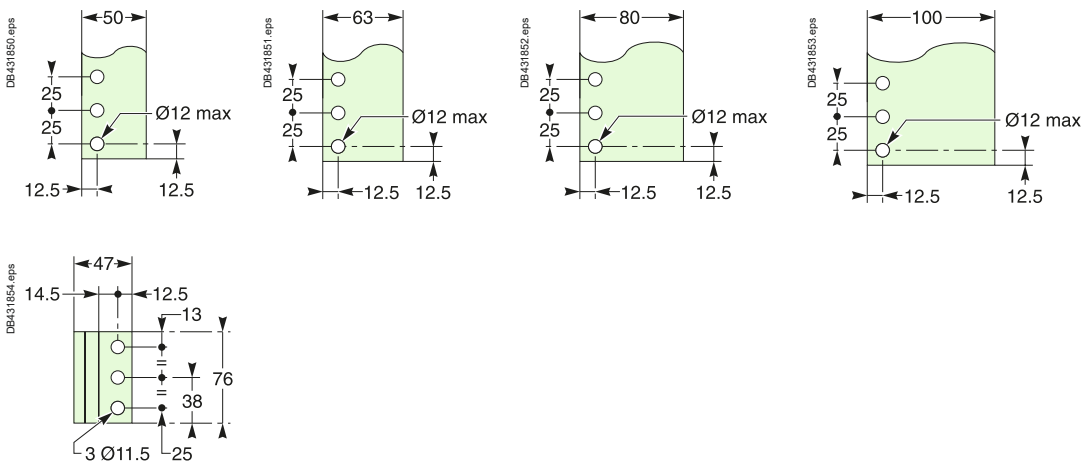

## Vertical Rear Connection NW40 DC - DC PV

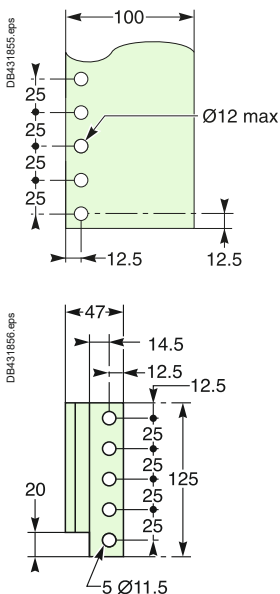

# MasterPact NW10 to NW40 DC, EPDC, DC PV Busbar Sizing

B

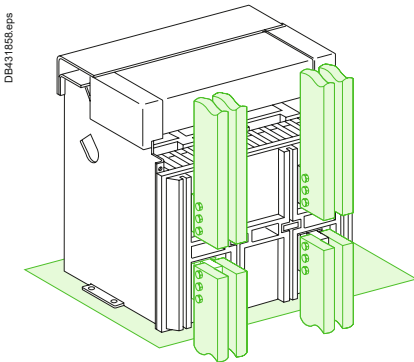
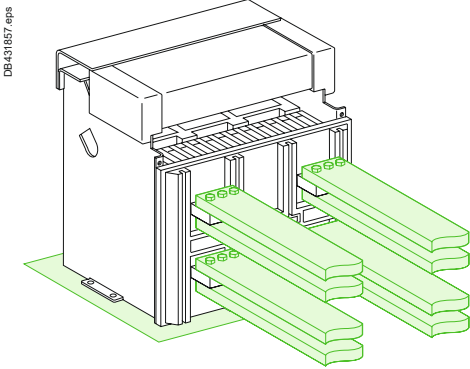

## Rear Horizontal Connection

### Basis of Tables

- Maximum permissible busbar temperature: 100 °C
- Ti: temperature around the circuit breaker and its connections
- Busbar material is unpainted copper.

### Example

Conditions:

- Drawout version
- Horizontal busbars
- Ti: 50 °C
- Service current: 2000 A.

### Solution

For Ti = 50 °C, use an NW20 DC - DC PV which can be connected with three 100 x 5 mm bars or two 80 x 10 mm bars.

MasterPact NW DC, EPDC, DC PV	Maximum service current	Ti: 40 °C no. of bars		Ti: 50 °C no. of bars		Ti: 60 °C no. of bars	
		5 mm thick bars	10 mm thick bars	5 mm thick bars	10 mm thick bars	5 mm thick bars	10 mm thick bars
NW10 DC, EPDC	1000	3b.50 x 5	1b.63 x 10	3b.50 x 5	2b.50 x 10	3b.63 x 5	2b.50 x 10
NW20 DC, EPDC	2000	3b.100 x 5	2b.80 x 10	3b.100 x 5	2b.80 x 10	3b.100 x 5	3b.80 x 10
NW20 HADCD-PV	2000	3b.100 x 5	2b.80 x 10	3b.100 x 5	2b.80 x 10	3b.100 x 5	3b.80 x 10

**Note:** The values indicated in these tables have been extrapolated from test data and theoretical calculations. These tables are only intended as a guide and cannot replace industrial experience or a temperature rise test.

## Rear Vertical Connection

### Basis of Tables

- Maximum permissible busbar temperature: 100 °C
- Ti: temperature around the circuit breaker and its connections
- Busbar material is unpainted copper.

### Example

Conditions:

- Fixed version
- Vertical busbars
- Ti: 40 °C
- Service current: 1000 A.

### Solution

For Ti = 40 °C, use an NW10 DC - DC PV which can be connected with two 50 x 5 mm bars or one 50 x 10 mm bar.

MasterPact NW DC, EPDC, DC PV	Maximum service current	Ti: 40 °C no. of bars		Ti: 50 °C no. of bars		Ti: 60 °C no. of bars	
		5 mm thick bars	10 mm thick bars	5 mm thick bars	10 mm thick bars	5 mm thick bars	10 mm thick bars
NW10 DC, EPDC	1000	2b.50 x 5	1b.50 x 10	2b.50 x 5	1b.50 x 10	2b.63 x 5	1b.63 x 10
NW20 DC, EPDC	2000	3b.100 x 5	2b.63 x 10	3b.100 x 5	2b.63 x 10	3b.100 x 5	3b.63 x 10
NW40 DC, EPDC	4000	-	4b.100 x 10	-	4b.100 x 10	-	4b.100 x 10
NW20 HADCD-PV	2000	3b.100 x 5	2b.63 x 10	3b.100 x 5	2b.63 x 10	3b.100 x 5	3b.63 x 10
NW40 HADCD-PV	4000	-	4b.100 x 10	-	4b.100 x 10	-	4b.100 x 10

**Note:** The values indicated in these tables have been extrapolated from test data and theoretical calculations. These tables are only intended as a guide and cannot replace industrial experience or a temperature rise test.

# MasterPact NW10 to NW40 DC, EPDC, DC PV Temperature Derating - Power Dissipation

## Temperature Derating

The table below indicates the maximum current rating, for each connection type, as a function of the ambient temperature around the circuit breaker and the busbars. For ambient temperatures greater than 60 °C, consult us. Ti: temperature around the circuit breaker and its connections.

Version	Drawout device										Fixed device															
Connection temp. Ti	Rear horizontal					Rear vertical					Rear horizontal					Rear vertical										
	40	45	50	55	60	40	45	50	55	60	40	45	50	55	60	40	45	50	55	60						
<b>NW DC</b>																										
<b>NW10</b>	<b>Version C</b>	1000					1000					1000					1000									
	<b>Version D</b>	1000					1000					1000					1000									
	<b>Version E</b>	1000					1000					1000					1000									
<b>NW20</b>	<b>Version C</b>	2000					2000					2000					2000									
	<b>Version D</b>	2000					2000					2000					2000									
	<b>Version E</b>	2000					2000					2000					2000									
<b>NW40</b>	<b>Version C</b>	-					4000					-					4000									
	<b>Version D</b>	-					4000					3900 3750 3600					-					4000				
	<b>Version E</b>	-					4000					3800 3650 3500					-					4000				
<b>NW EPDC</b>																										
<b>NW10 EPDC-D</b>	1000					1000					-					-										
<b>NW20 EPDC-D</b>	2000					2000					-					-										
<b>NW40 EPDC-D</b>	-					4000					3900 3750 3600					-					-					
<b>NW DC PV</b>																										
<b>NW20 Version D</b>	2000					2000					2000					2000										
<b>NW40 Version D</b>	-					4000					3900 3750 3600					-					4000					

## Power Dissipation

Total power dissipation is the value measured at IN, for a 3 pole (version C, D [1]) or 4 pole (version E) breaker (values above the power P = 3RI<sup>2</sup>).

[1] DC PV version D only.

Version	Drawout device			Fixed device		
	Power dissipation (Watt)			Power dissipation (Watt)		
Version	C	D	E	C	D	E
<b>NW10 DC</b>	45	75	105	25	40	60
<b>NW20 DC</b>	135	230	330	90	160	235
<b>NW40 DC</b>	460	800	1150	360	580	850

Version	Drawout device	No Fixed device
	Power dissipation (Watt)	
Version	D	
<b>NW10 EPDC-D</b>	75	
<b>NW20 EPDC-D</b>	230	
<b>NW40 EPDC-D</b>	800	

Version	Drawout device	Fixed device
	Power dissipation (Watt)	Power dissipation (Watt)
Version	D	D
<b>NW20 HADCD-PV</b>	230	160
<b>NW40 HADCD-PV</b>	800	580









# Dimensions and Connection

## ComPacT (Fixed Version) 1P-2P

### NSX100-NSX160 DC

Dimensions, Mounting, Cutout..... C-4

### Dimensions and Mounting

ComPacT NSX100 to 1200 DC Fixed Version..... C-6

ComPacT NSX100 to 630 DC Plug-in Version ..... C-8

ComPacT NSX100 to 630 DC Withdrawable Version ..... C-10

Motor Mechanism Module for ComPacT NSX100 to 1200 DC ..... C-12

Direct Rotary Handle for ComPacT NSX100 to 1200 DC ..... C-13

MCC and CNOMO Type Direct Rotary Handles

for ComPacT NSX100 to 1200 DC Fixed Version ..... C-14

Extended Rotary Handle

for ComPacT NSX100 To1200 DC ..... C-15

### Front-Panel Accessories..... C-16

ComPacT NSX100 to 1200 DC..... C-16

### Power Connections

ComPacT NSX100 to 1200 DC Fixed Version..... C-18

ComPacT NSX100 to 630 DC Fixed Version..... C-20

Connection of Insulated Bars or Cables with Lugs to

ComPacT NSX100 to 1200 DC..... C-22

Connection of Bare Cables to ComPacT NSX100 to 1200 DC..... C-23

## ComPacT (Fixed Version) 2P-3P-4P

### Parallel and Series Connection of Poles

ComPacT NSX100 to NSX250 DC ..... C-24

ComPacT NSX400 to NSX630 DC ..... C-25

## ComPacT (Fixed Version) 4P

### Parallel and Series Connection of Poles

ComPacT NSX630 to NSX1200 DC ..... C-26

## ComPacT (Withdraw. Version) 3P-4P

### Parallel and Series Connection of Poles

ComPacT NSX100 to NSX250 DC ..... C-27

ComPacT NSX400 to NSX630 DC ..... C-28

## ComPacT (Fixed Version)

### 4P Connection of Poles, Dimensions and Mounting

ComPacT NSX100 to NSX630 DC PV - DC EP ..... C-29

## ComPacT (Fixed Version)

### 4P Connection of Poles, Dimensions

ComPacT NSX630b to 1600 DC PV ..... C-30

### Other Chapters

Presentation ..... 2

Functions and Characteristics ..... A-1

Installation Recommendations..... B-1

Electrical Diagrams..... D-1

Additional Characteristics..... E-1

Catalog Numbers and Order Form ..... F-1





## Dimensions and Connection

### ComPacT (Fixed Version)

#### 4P Rear Connection of Poles, Mounting

ComPacT NSX630b to 1600 DC PV ..... C-32

### MasterPact (Fixed Device)

NW10 to 40 DC Version C/D (3P),

Version E (4P) NW10 to 40 EPDC, DC PV Version D (3P) ..... C-33

NW10 to 40 DC–Version C ..... C-34

NW10 to 40 DC–DC PV–Version D ..... C-35

NW10 to 40 DC–Version E ..... C-36

### MasterPact (Drawout Device)

NW10 to 40 DC Version C/D (3P) Version E (4P)

NW10 to 40 DC PV Version D (3P) ..... C-37

NW10 to 40 DC–Version C ..... C-38

NW10 to 40 DC, EPDC, DC PV–Version D ..... C-39

NW10 to 40 DC–Version E ..... C-40

### MasterPact NW10 to 40 DC, EPDC, DC PV

Accessories ..... C-41

### Dimensions and Mounting

External Modules for ComPacT and MasterPact ..... C-43

FDM121 Switchboard Display ..... C-44

FDM128 Switchboard Display ..... C-45

### Other Chapters

Presentation ..... 2

Functions and Characteristics ..... A-1

Installation Recommendations ..... B-1

Electrical Diagrams ..... D-1

Additional Characteristics ..... E-1

Catalog Numbers and Order Form ..... F-1



**Other Chapters**

Presentation .....	2
Functions and Characteristics .....	A-1
Installation Recommendations .....	B-1
Electrical Diagrams .....	D-1
Additional Characteristics .....	E-1
Catalog Numbers and Order Form .....	F-1

# ComPacT (Fixed Version) 1P-2P NSX100-NSX160 DC

## Dimensions, Mounting, Cutout

### Dimensions

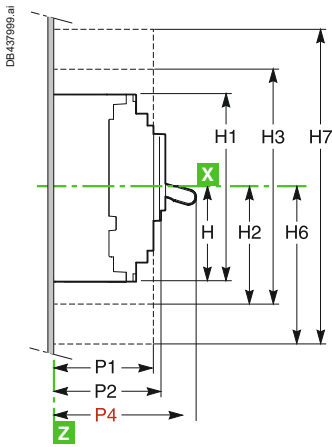

1 pole

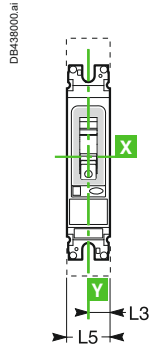

2 poles

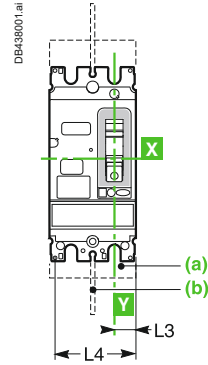

[a] Short terminal shields  
[b] Interphase barriers

### Mounting

On Backplate

1 pole

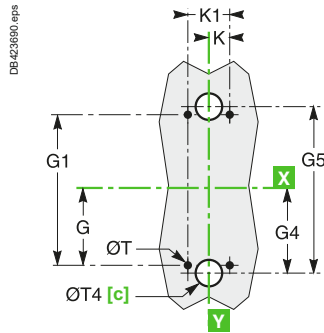

[c] For rear connection only.

2 poles

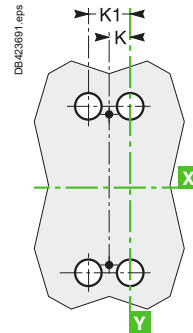

### On Rails

1 pole

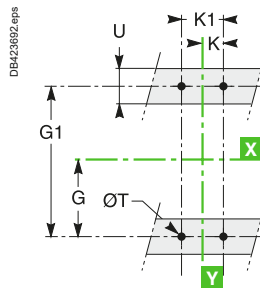

2 poles

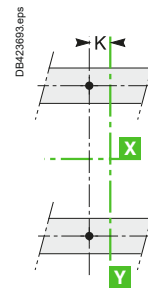

# ComPacT (Fixed Version) 1P-2P NSX100-NSX160 DC

## Dimensions, Mounting, Cutout

### Front-Panel Cutout

#### On Backplate

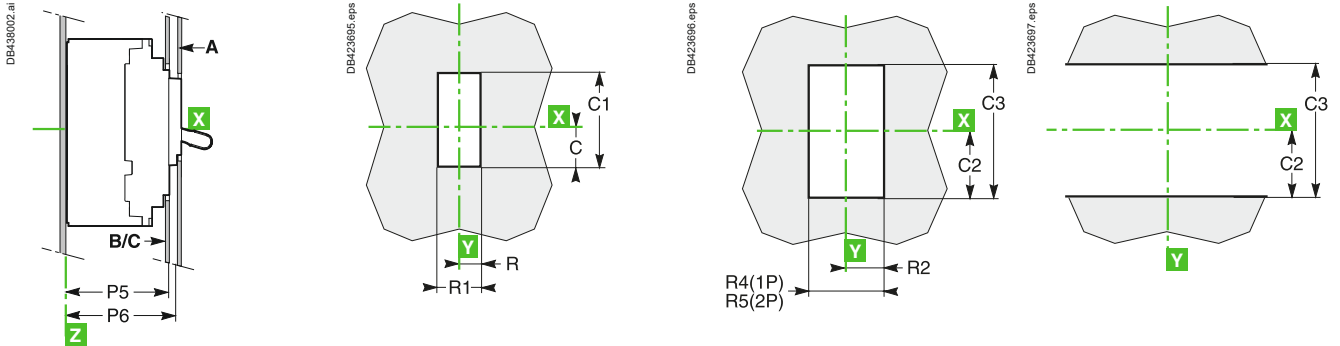

#### With Escutcheon

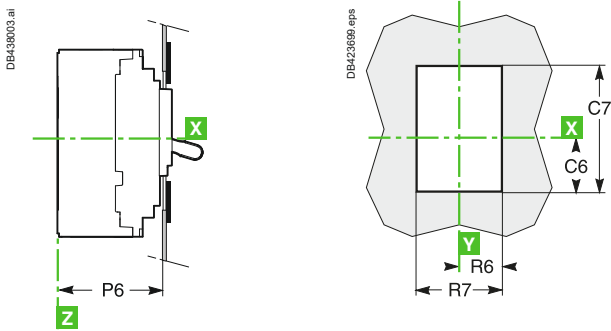

#### Dimensions (mm)

Type	C	C1	C2	C3	C6	C7	G	G1	G4	G5	H
NSX100/160 DC	29	76	54	108	43	104	62.5	125	70	140	80.5
Type	H1	H2	H3	H4	H6	H7	K	K1	L3	L4	L5
NSX100/160 DC	161	94	188	160.5	178.5	357	17.5	35	17.5	70	35
Type	P1	P2	P4	P5	P6	R	R1	R2	R4	R5	R6
NSX100/160 DC	81	86	111	83	88	14.5	29	19	38	73	29
Type	R7	ØT	ØT4	U							
NSX100/160 DC	58	6	22	≤ 32							

# Dimensions and Mounting

## ComPacT NSX100 to 1200 DC Fixed Version

### Dimensions

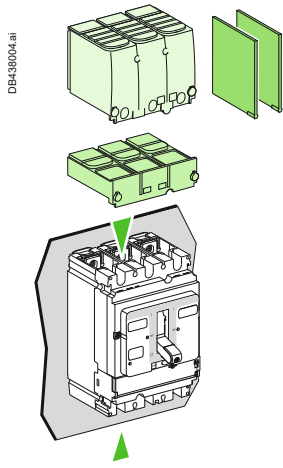

- Interphase barriers
- Short terminal shields

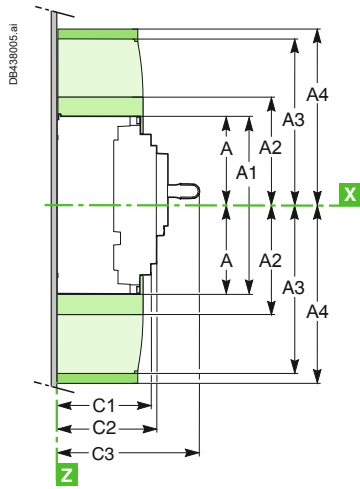

### 3P

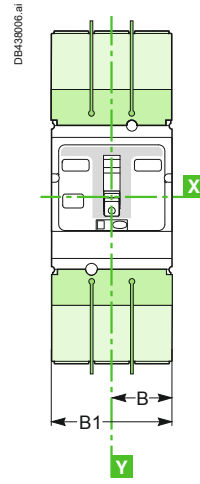

### 4P, 2P (4P Circuit Breaker Platform)

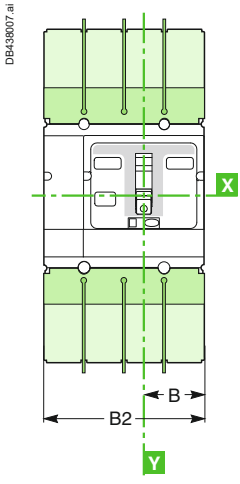

Long terminal shields (also available for NSX400/630 DC spreaders with 52.5 mm pitch: B1 = 157.5 mm, B2 = 210 mm)

### Mounting On Backplate

#### NSX100 to 250 DC 3P

#### NSX400/630 DC 3P

#### NSX100 to 1200 DC 4P, 2P (4P Circuit Breaker Platform)

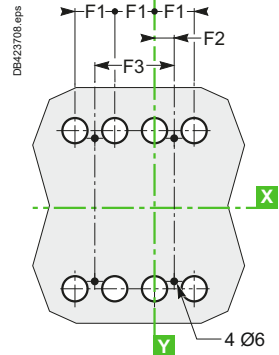
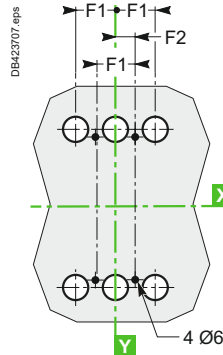
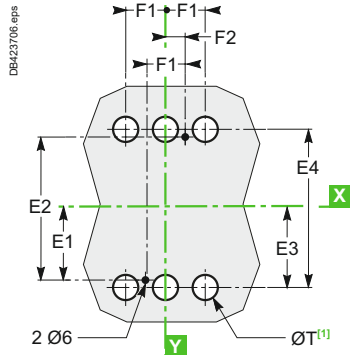
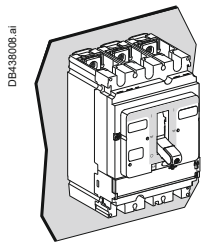

[1] The ØT holes are required for rear connection only.

### On Rails

#### 3P

#### 3P

#### 4P, 2P (4P Circuit Breaker Platform)

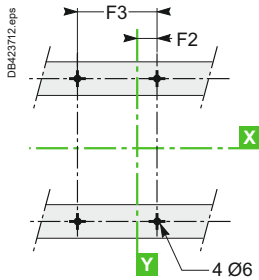
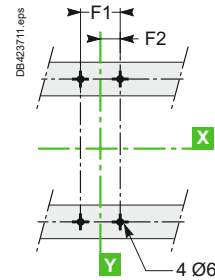
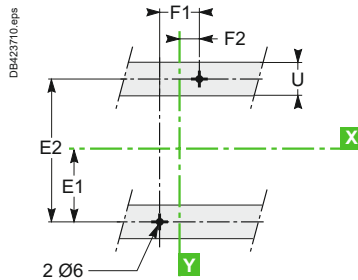
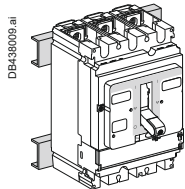

# Dimensions and Connection

## Dimensions and Mounting

### ComPacT NSX100 to 1200 DC Fixed Version

#### On DIN Rail with Adapter Plate (NSX100 to 250 DC)

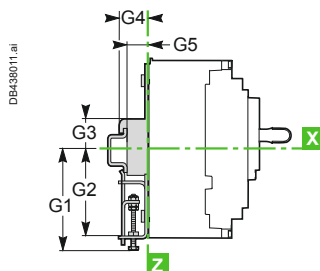
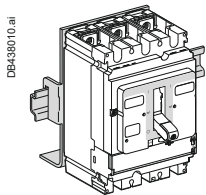

#### Dimensions (mm)

Type	A	A1	A2	A3	A4	B	B1	B2	C1	C2	C3
NSX100/160/250 DC	80.5	161	94	145	178.5	52.5	105	140	81	86	126
NSX400/630 DC	127.5	255	142.5	200	237	70	140	185	95.5	110	168
NSX1200 DC	-	-	-	240	-	70	-	185	95.5	110	168
Type	E1	E2	F1	F2	F3	G1	G2	G3	G4	G5	
NSX100/160/250 DC	62.5	125	35	17.5	70	95	75	13.5	23	17.5	
NSX400/630 DC	100	200	45	22.5	90	-	-	-	-	-	
NSX1200 DC	100	200	-	22.5	90	-	-	-	-	-	





# Dimensions and Mounting

## ComPacT NSX100 to 630 DC Plug-in Version

### Dimensions

### 3P

### 4P

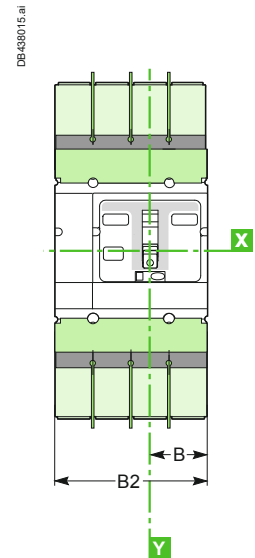
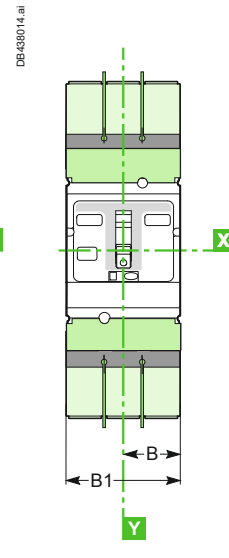
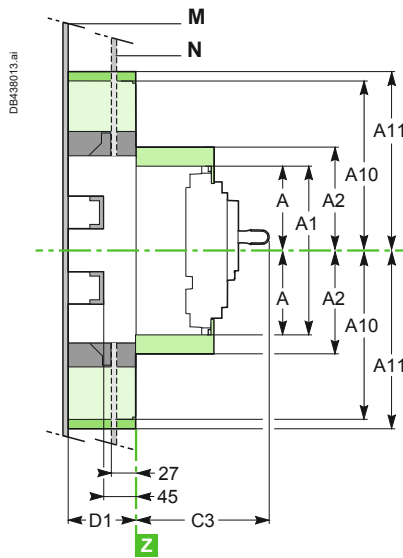
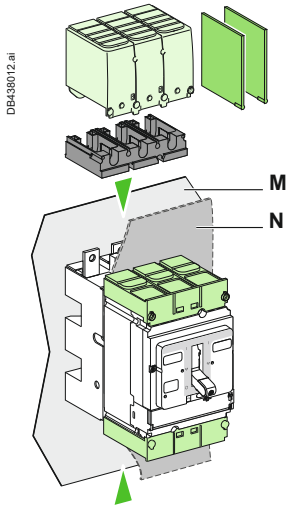

Interphase barriers for base  
 Short terminal shields on circuit breaker

Long terminal shields (also available for NSX400/630 DC spreaders with 52.5 mm pitch: /B1 = 157.5 mm, B2 = 210 mm)

Adapter for base, required to mount long terminal shields or interphase barriers

### Mounting

#### Through Front Panel (N) 3P

#### 3P

#### 4P

NSX100 to 250 DC

NSX400/630 DC

NSX100 to 630 DC

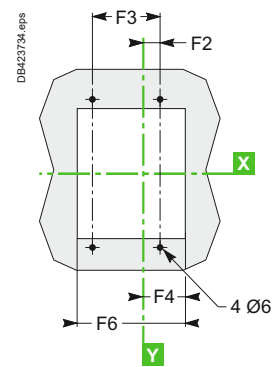
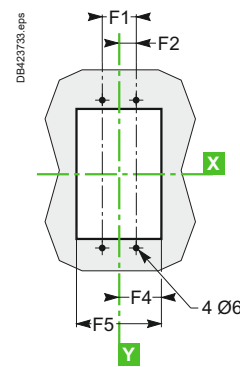
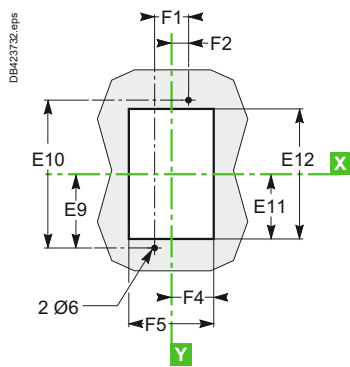
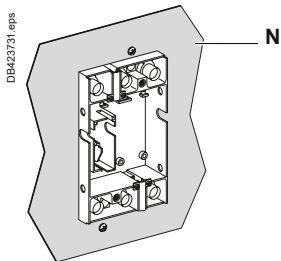

# Dimensions and Connection

## Dimensions and Mounting

### ComPacT NSX100 to 630 DC Plug-in Version

#### On Backplate (M)

#### 3P

#### 4P

Front connection (an insulating screen is supplied with the base and must be be fitted between the base and the backplate)

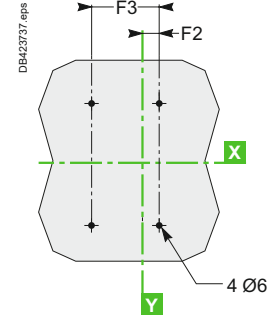
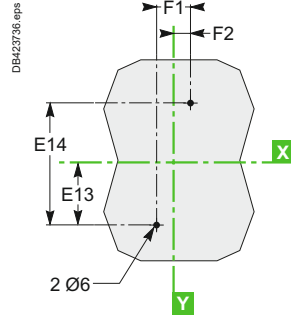
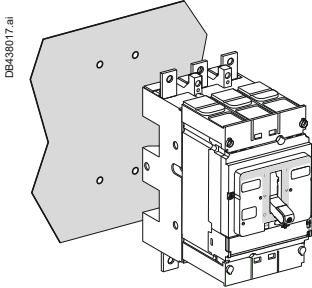

#### Connection by exterior-mounted rear connectors

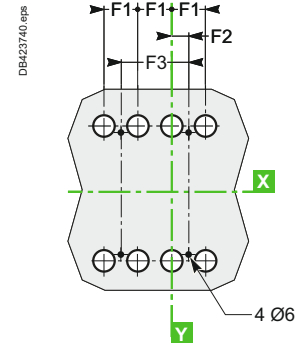
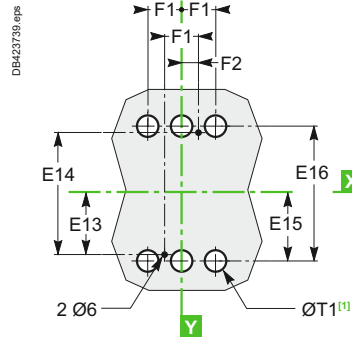
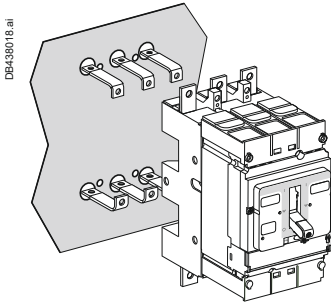

[1] The ØT1 holes are required for rear connection only.

#### Connection by interior-mounted rear connectors

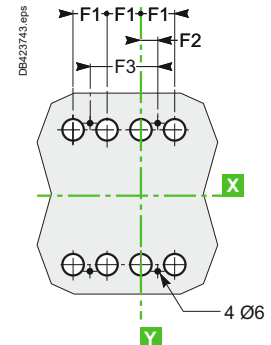
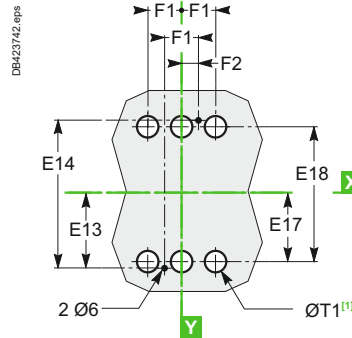
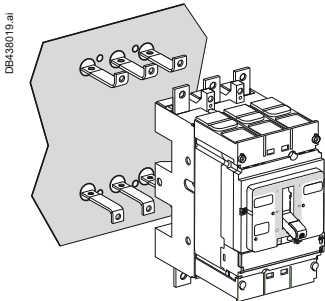

[1] The ØT1 holes are required for rear connection only.

#### On Rails

#### 3P

#### 4P

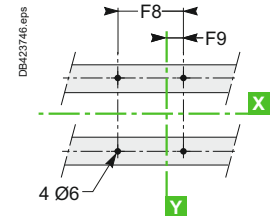
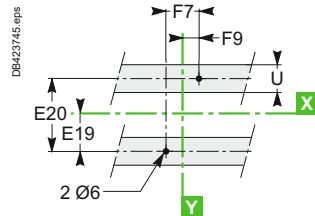
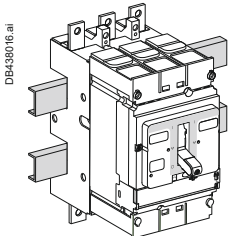

Type	A	A1	A2	A10	A11	B	B1	B2	C3	D1	E9	E10	E11	E12	E13	E14	E15
NSX100/160/250 DC	80.5	161	94	175	210	52.5	105	140	126	75	95	190	87	174	77.5	155	79
NSX400/630 DC	127.5	255	142.5	244	281	70	140	185	168	100	150	300	137	274	125	250	126
Type	E16	E17	E18	E19	E20	F1	F2	F3	F4	F5	F6	F7	F8	F9	ØT1	U	
NSX100/160/250 DC	158	61	122	37.5	75	35	17.5	70	54.5	109	144	70	105	35	24	≤ 32	
NSX400/630 DC	252	101	202	75	150	45	22.5	90	71.5	143	188	100	145	50	33	≤ 35	



# Dimensions and Mounting

## ComPacT NSX100 to 630 DC Withdrawable Version

### Dimensions

### 3P

### 4P

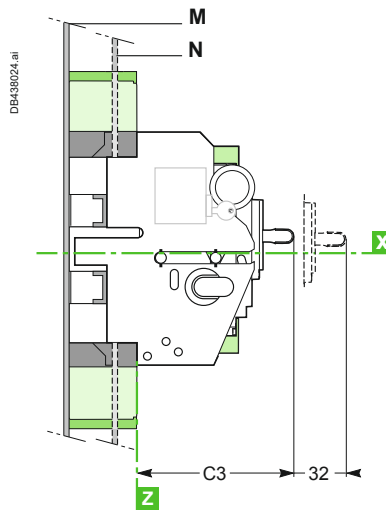
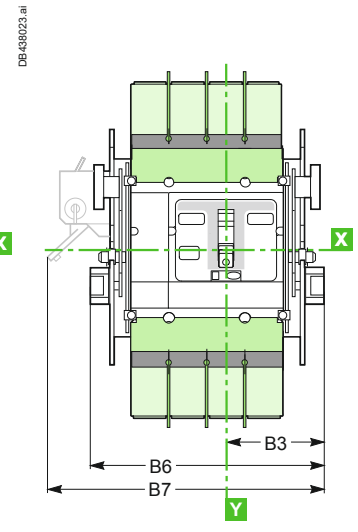
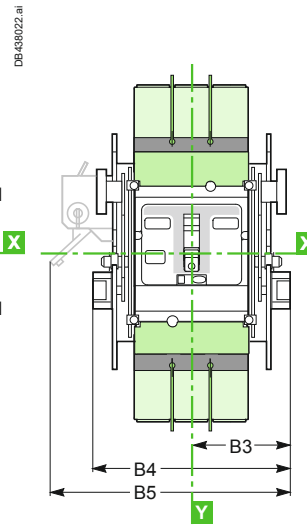
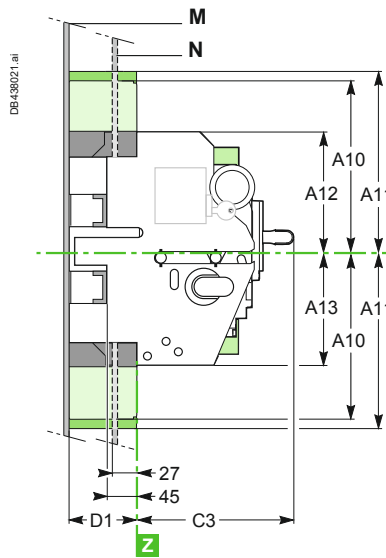
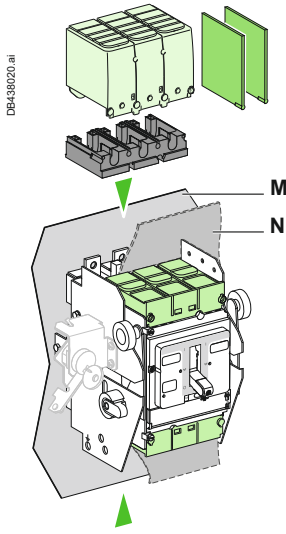

- Interphase barriers for base
- Short terminal shields on circuit breaker
- Long terminal shields
- Adapter for base, required to mount long terminal shields or interphase barriers

### Mounting

#### Through Front Panel (N)

### 3P

### 3P

### 4P

NSX100 to 250 DC

NSX400/630 DC

NSX100 to 630 DC

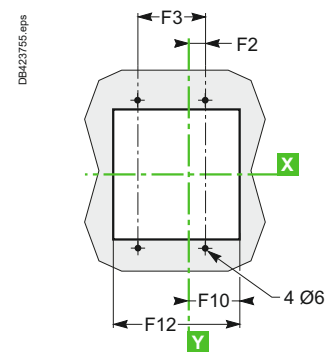
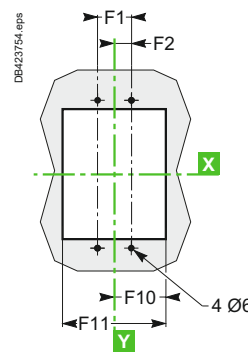
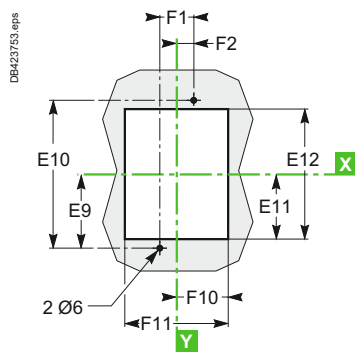
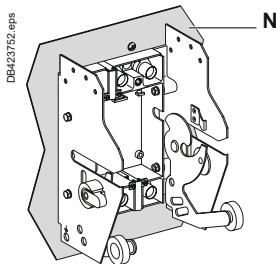

# Dimensions and Connection

## Dimensions and Mounting

### ComPacT NSX100 to 630 DC Withdrawable Version

#### On Backplate (M)

3P

4P

Front connection (an insulating screen is supplied with the base and must be fitted between the base and the backplate)

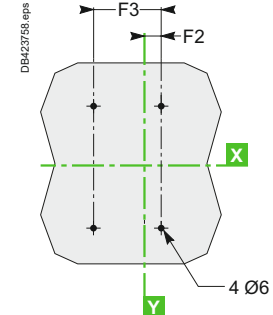
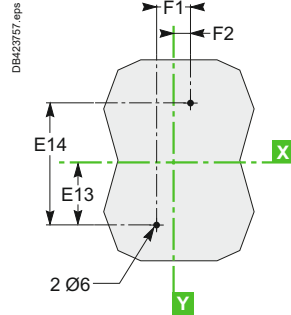
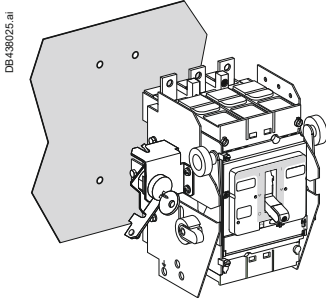

#### Connection by exterior-mounted rear connectors

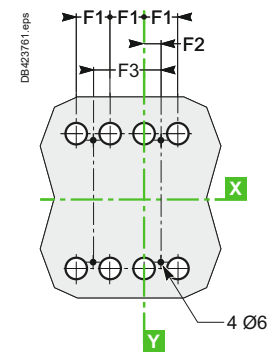
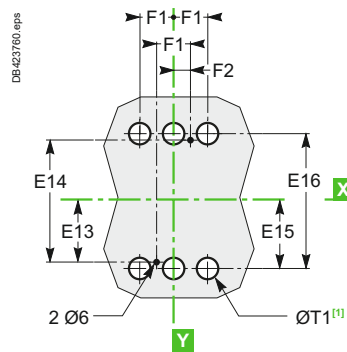
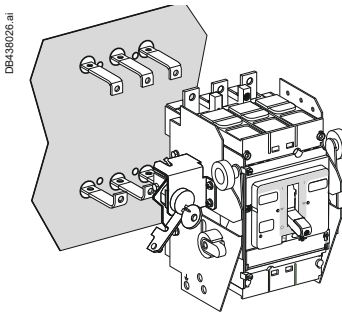

[1] The ØT1 holes are required for rear connection only.

#### Connection by interior-mounted rear connectors

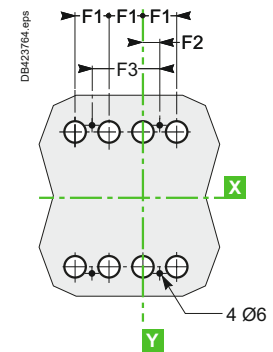
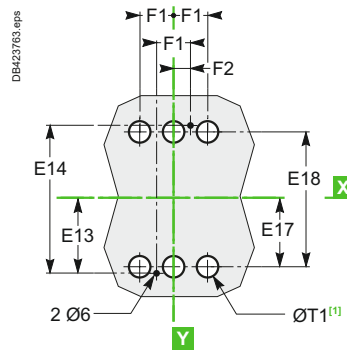
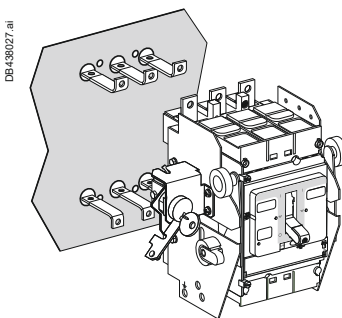

[1] The ØT1 holes are required for rear connection only.

#### On Rails

3P

4P

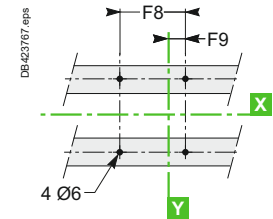
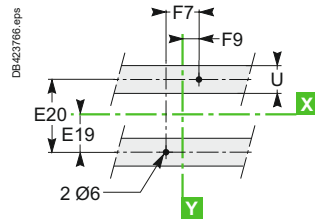
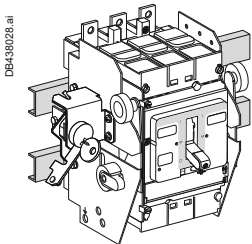

Type	A10	A11	A12	A13	B3	B4	B5	B6	B7	C3	D1	E9	E10	E11	E12	E13	E14
NSX100/160/250 DC	175	210	106.5	103.5	92.5	185	216	220	251	126	75	95	190	87	174	77.5	155
NSX400/630 DC	244	281	140	140	110	220	250	265	295	168	100	150	300	137	274	125	250
Type	E15	E16	E17	E18	E19	E20	F1	F2	F3	F7	F8	F9	F10	F11	F12	ØT1	U
NSX100/160/250 DC	79	158	61	122	37.5	75	35	17.5	70	70	105	35	74	148	183	24	≤ 32
NSX400/630 DC	126	252	101	202	75	150	45	22.5	90	100	145	50	91.5	183	228	33	≤ 35

# Dimensions and Mounting

## Motor Mechanism Module for ComPacT NSX100 to 1200 DC

### Dimensions

### 3P

### 4P, 2P(4P Circuit Breaker Platform)

#### Fixed Circuit Breaker

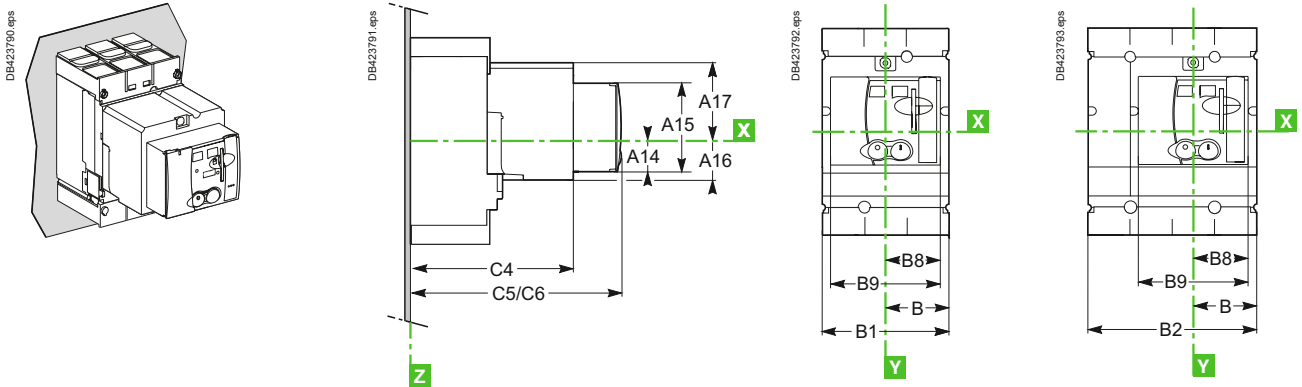

C5: without keylock  
C6: with keylock

#### Plug-in Circuit Breaker

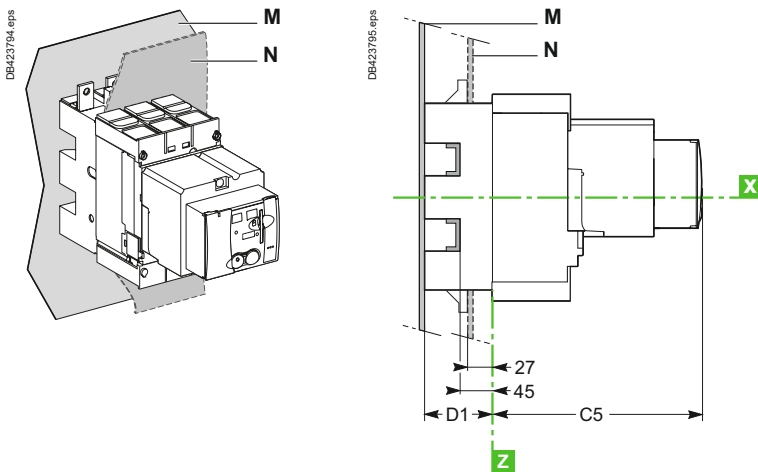

#### Withdrawable Circuit Breaker

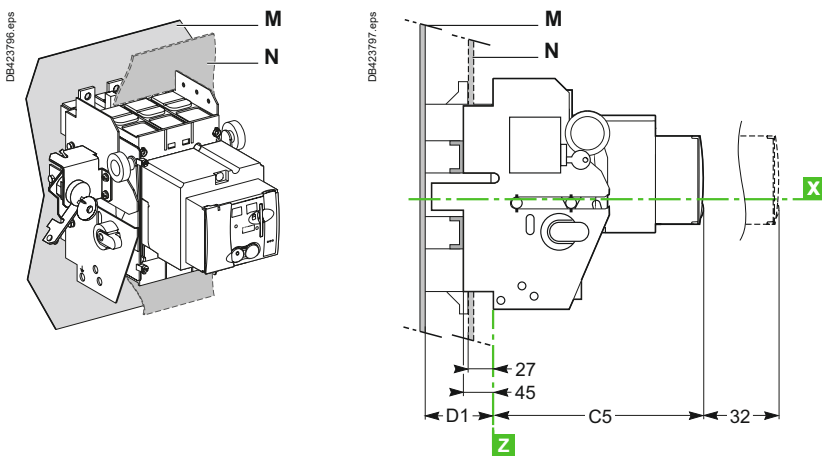

Type	A14	A15	A16	A17	B	B1	B2	B8	B9	C4	C5	C6	D1
NSX100/160/250 DC	27.5	73	34.5	62.5	52.5	105	140	45.5	91	143	182	209.5	75
NSX400/630 DC	40	123	52	100	70	140	185	61.5	123	215	256	258	100
NSX1200 DC	40	123	52	100	70	140	185	61.5	123	215	-	258	-

# Dimensions and Mounting

## Direct Rotary Handle for ComPacT NSX100 to 1200 DC

### Dimensions

### 3P

### 4P, 2P (4P Circuit Breaker Platform)

#### Fixed Circuit Breaker

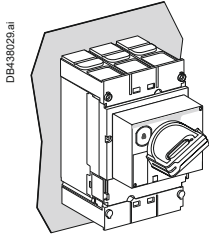

DE438029.ai

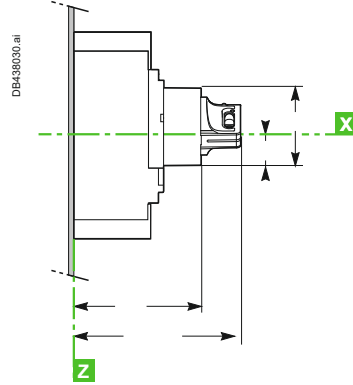

DE438030.ai

DE438031.ai

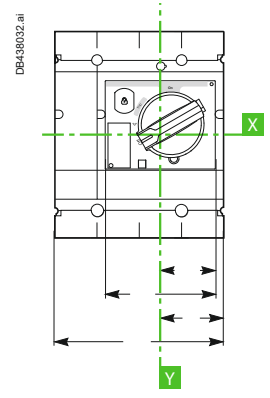
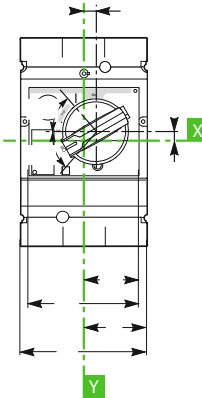

DE438032.ai

C8: without keylock  
C9: with keylock

#### Plug-in Circuit Breaker

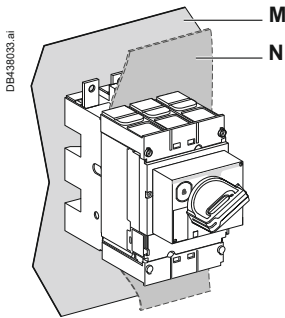

DE438033.ai

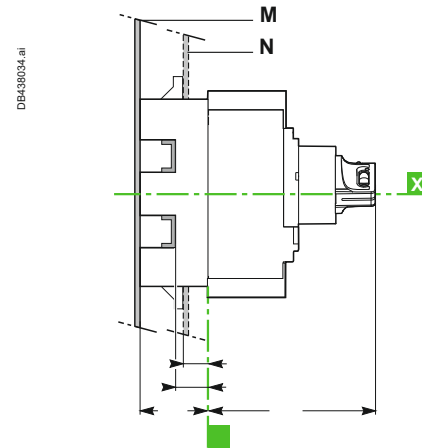

DE438034.ai

#### Withdrawable Circuit Breaker

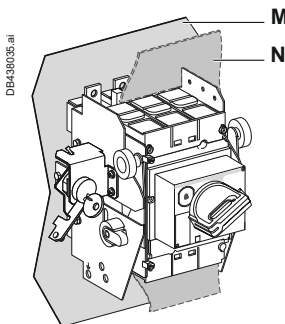

DE438035.ai

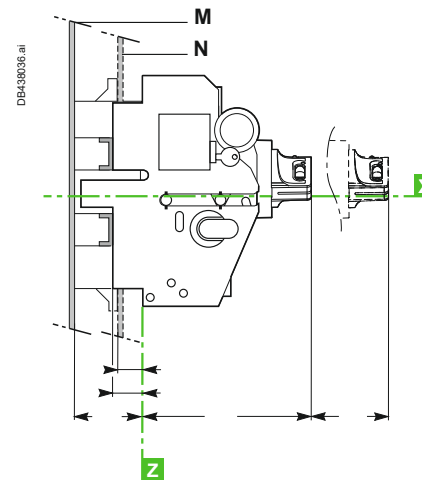

DE438036.ai

Type	A14	A15	A18	B	B1	B2	B8	B9	B10	C7	C8	C9	D1
NSX100/160/250 DC	27.5	73	9	52.5	105	140	45.5	91	9.25	121	155	164	75
NSX400/630 DC	40	123	24.6	70	140	185	61.5	123	5	145	179	188	100
NSX1200 DC	40	123	24.6	70	140	185	61.5	123	5	145	-	188	-



Dimensions and Connection

# Dimensions and Mounting

## MCC and CNOMO Type Direct Rotary Handles for ComPacT NSX100 to 1200 DC Fixed Version

### Dimensions

#### MCC Type Direct Rotary Handle

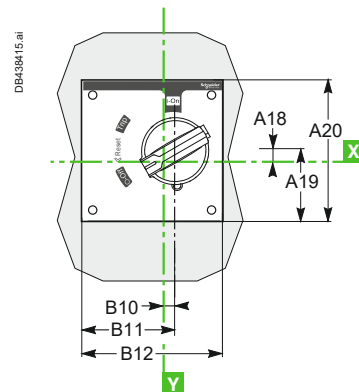
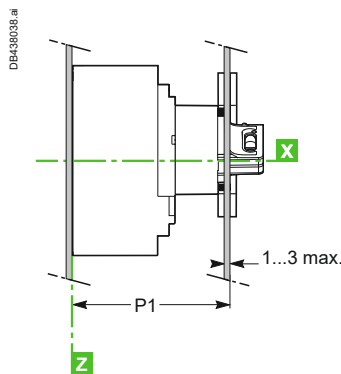
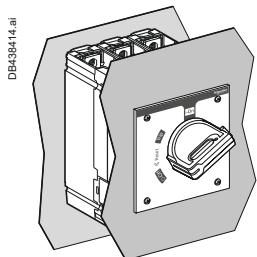

#### CNOMO Type Direct Rotary Handle

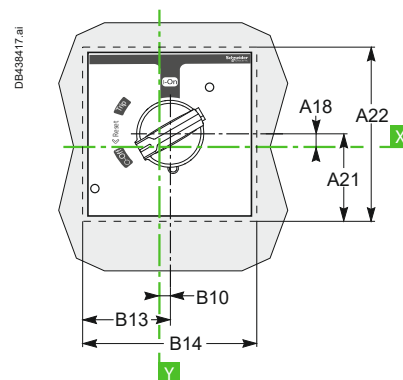
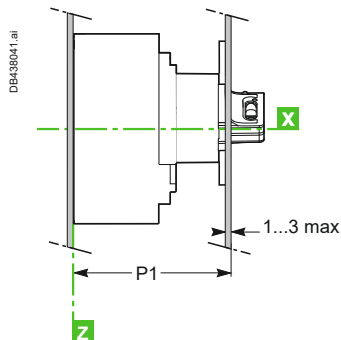
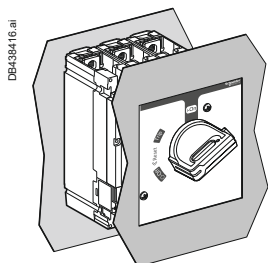

### Front-Panel Cutout

#### MCC Type Direct Rotary Handle

#### NSX100 to 250 DC

#### NSX400/630/1200 DC

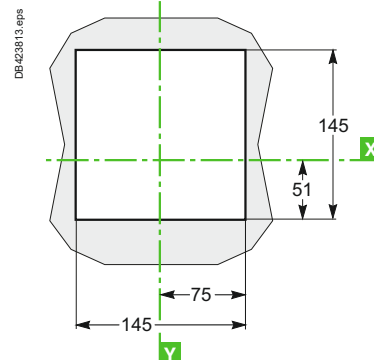
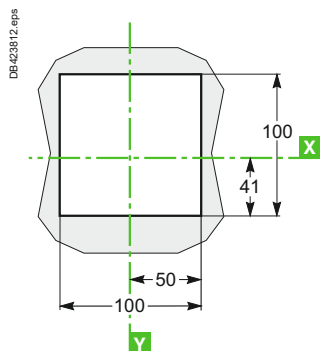
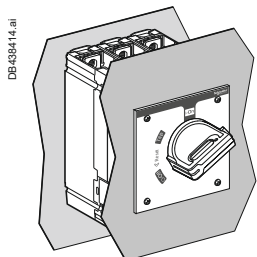

#### CNOMO Type Direct Rotary Handle

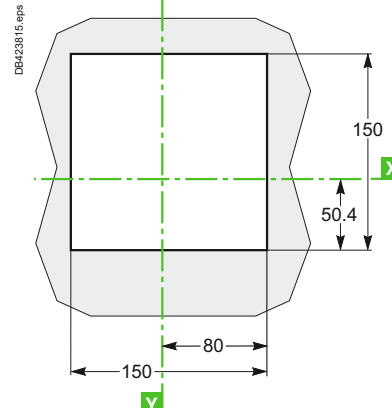
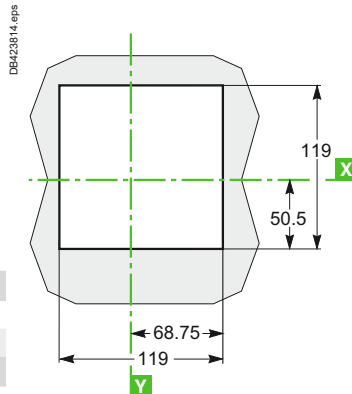
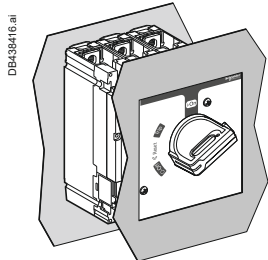

Type	A18	A19	A20	A21	A22	B10
NSX100/160/250 DC	9	60	120	65	130	9.25
NSX400/630/1200 DC	24.6	83	160	82	164	5
Type	B11	B12	B13	B14	P1	P2
NSX100/160/250 DC	69	120	65	130	125	135
NSX400/630/1200 DC	85	160	82	164	149	158



# Dimensions and Connection

## Extended Rotary Handle for ComPacT NSX100 To1200 DC

### Dimensions

#### Fixed and Plug-in Circuit Breakers

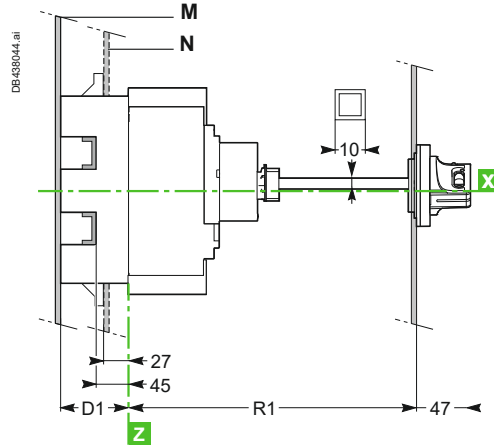
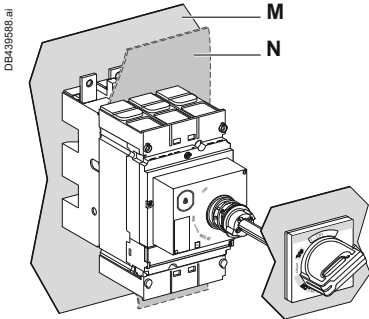

Cutout for shaft (mm)	
Type	R1
NSX100/160/250 DC	min. 171 max. 600
NSX400/630/1200 DC	min 195 max. 600

#### Withdrawable Circuit Breaker

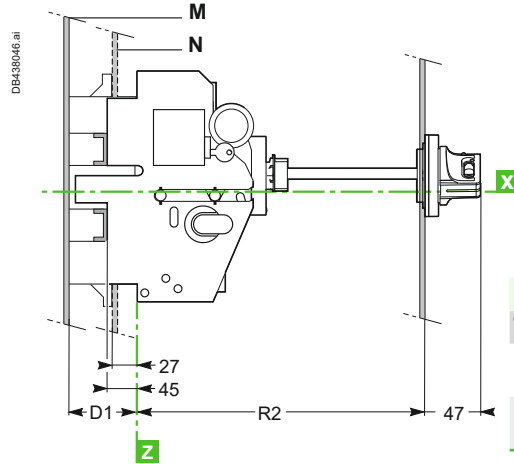
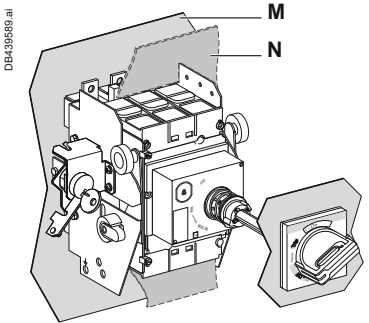

Cutout for shaft (mm)	
Type	R2
NSX100/160/250 DC	min. 248 max. 600
NSX400/630 DC	min. 272 max. 600

#### Dimensions and Front-Panel Cutout

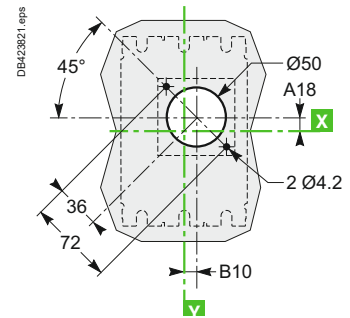
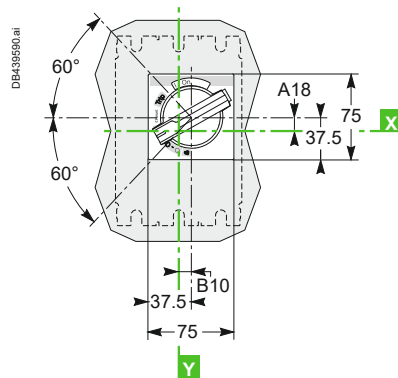

Type	A18	B10	D1
NSX100/160/250 DC	9	9.25	75
NSX400/630/1200 DC	24.6	5	100



# Dimensions and Connection

## Front-Panel Accessories

### ComPacT NSX100 to 1200 DC

#### IP30 Front-Panel Escutcheons

For Toggle, Rotary Handle or Motor Mechanism Module

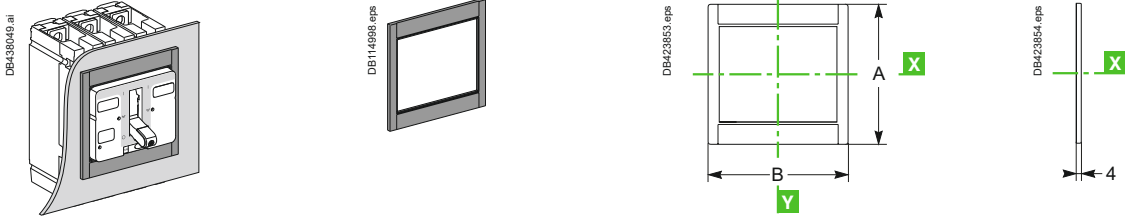

For Toggle or Rotary Handle with Access to Trip Unit

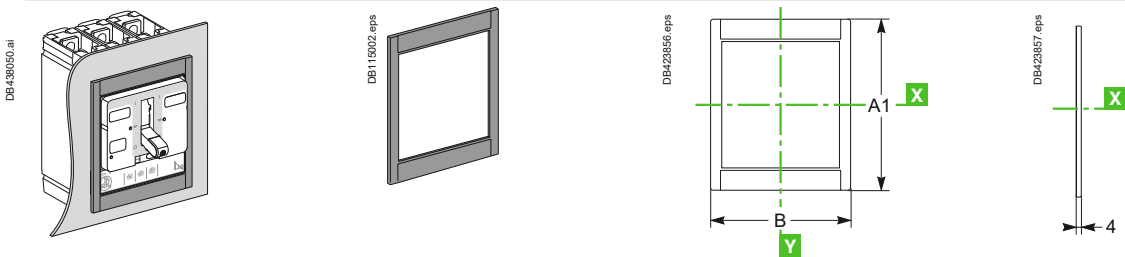

#### IP40 Front-Panel Escutcheons

For Toggle, Rotary Handle or Motor Mechanism Module and Protection Collar

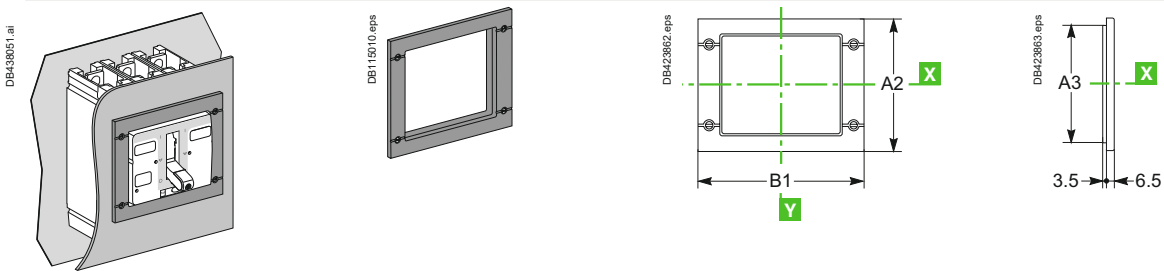

#### Protection Collars for IP40 Front-Panel Escutcheons

For Toggle

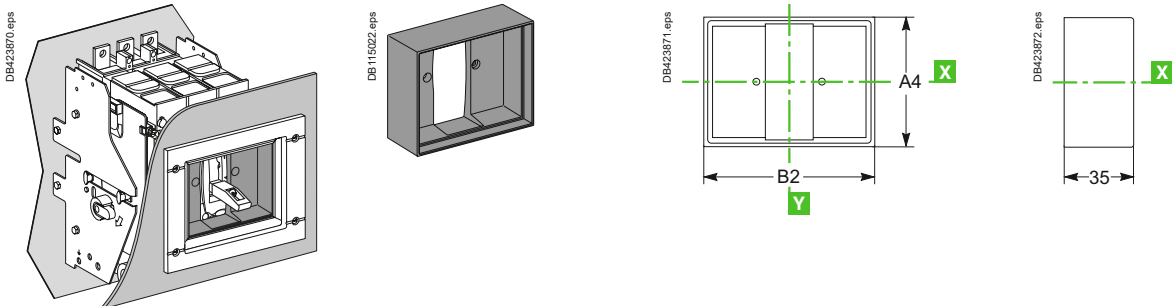

# Dimensions and Connection

## Front-Panel Accessories

### ComPacT NSX100 to 1200 DC

#### IP43 Toggle Cover

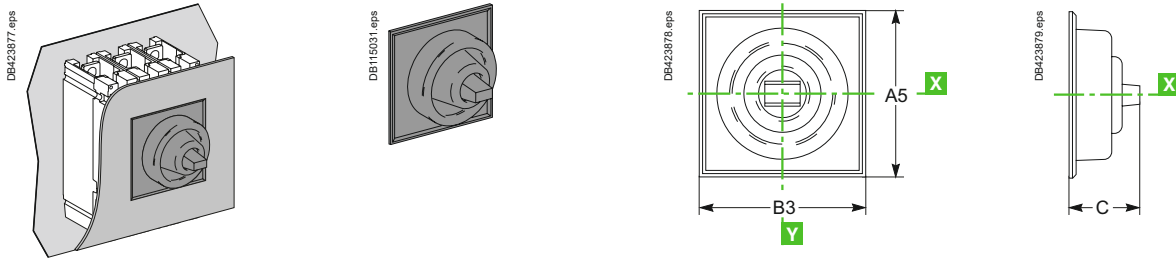

Type	A	A1	A2	A3	A4	A5	B	B1	B2	B3	C
NSX100/160/250 DC	113	138	114	101	73	85	<b>113</b>	157	91	<b>103</b>	40
NSX400/630/1200 DC	163	211	164	151	122.5	138	163	189	122.5	138	60



# Power Connections

## ComPacT NSX100 to 1200 DC Fixed Version

### Front Connection without Accessories

DB438052.ai

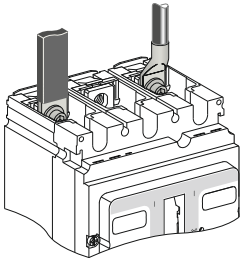

NSX100 to 250 DC

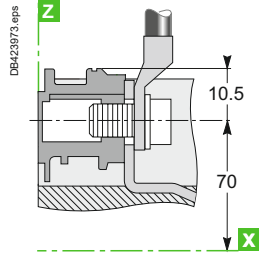

Cables with lugs/bars

NSX400/630 DC

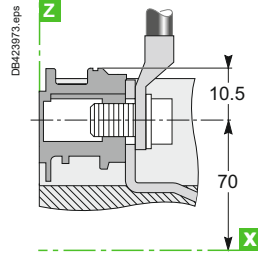

Bars/cables with lugs

NSX1200 DC

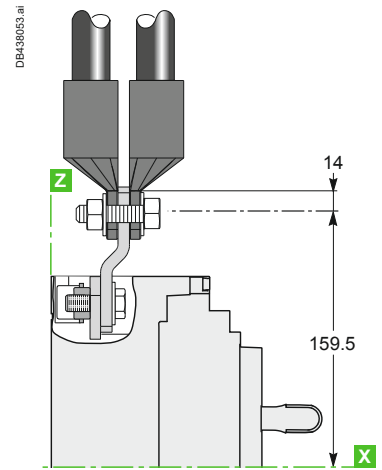

C

### Connection with Accessories

#### Long and Short Rear Connectors

DB438054.ai

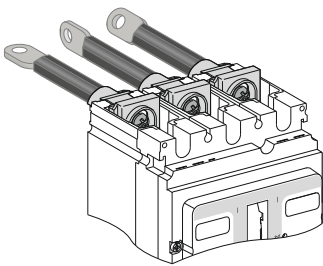

NSX100 to 250 DC

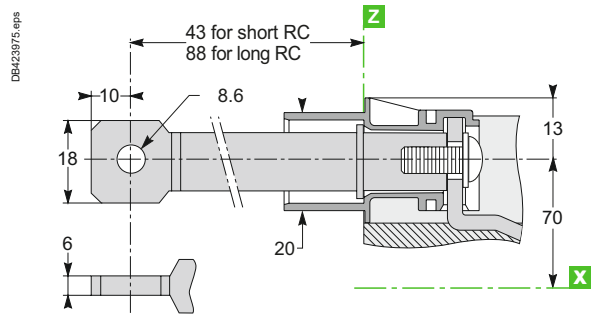

NSX400/630 DC

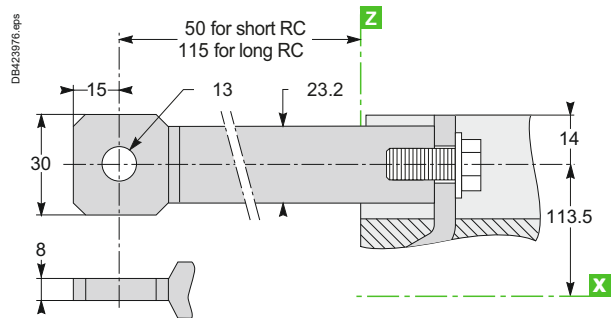

#### Bare-Cable Connectors

DB438055.ai

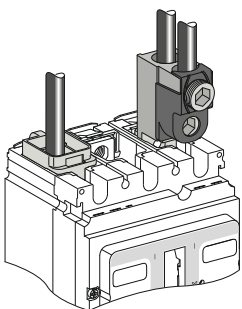

NSX100 to 250 DC

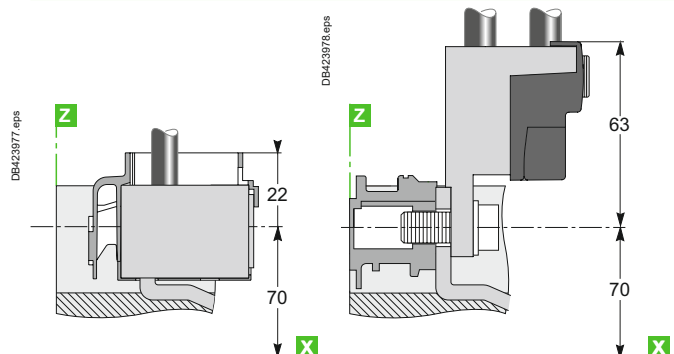

# Dimensions and Connection

## Power Connections

### ComPacT NSX100 to 1200 DC Fixed Version

#### Connection with Accessories (Cont.)

##### Bare-Cable Connectors

##### NSX400/1200 DC

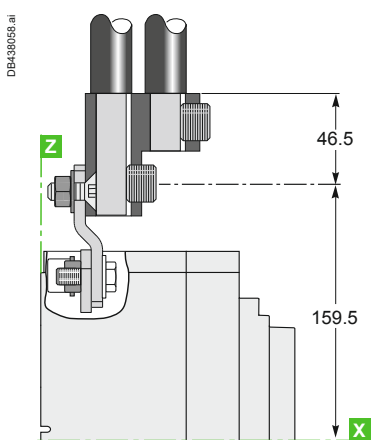
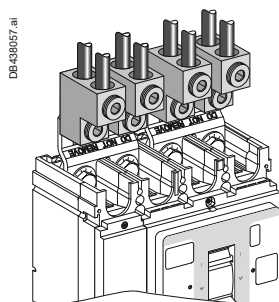
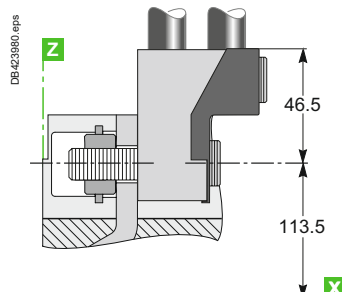
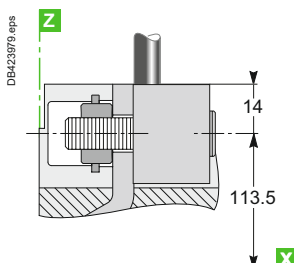
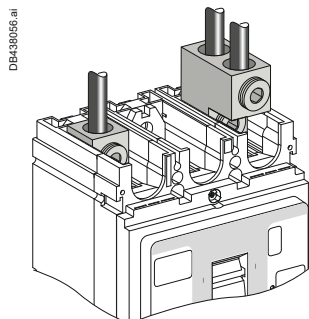

##### Distribution Connectors (for NSX100 to 250 DC Only)

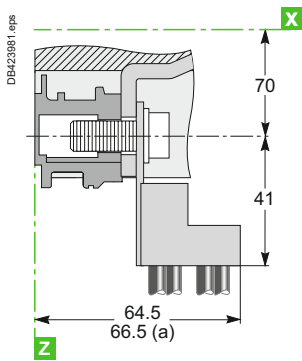
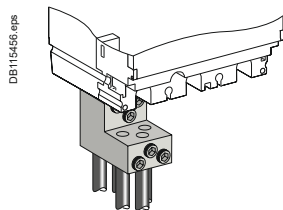

(a) NSX250 DC

##### Right-Angle Terminal Extensions (Upstream Only)

##### NSX100 to 250 DC

##### NSX400/630 DC

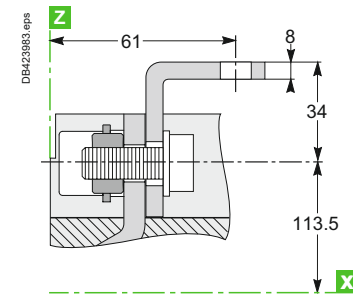
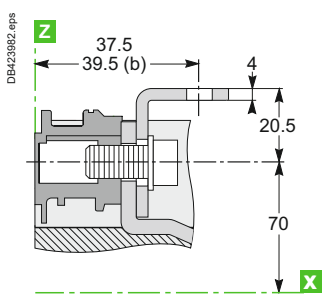
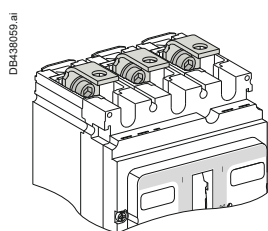

(b) NSX250 DC



# Power Connections

## ComPacT NSX100 to 630 DC Fixed Version

### Connection with Accessories (Cont.)

Straight Terminal Extensions (for NSX100 to 250 DC Only)

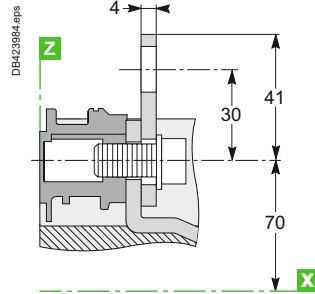
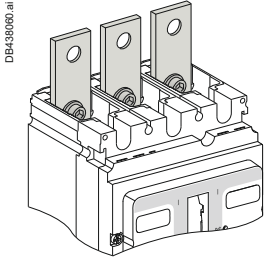

Edgewise Terminal Extensions

NSX100 to 250 DC

NSX400/630 DC

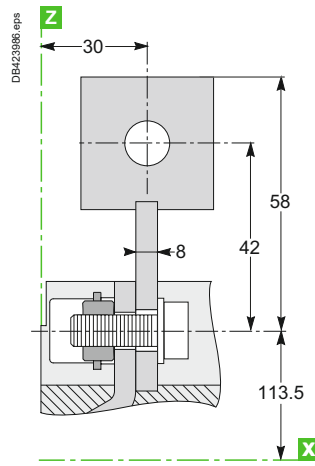
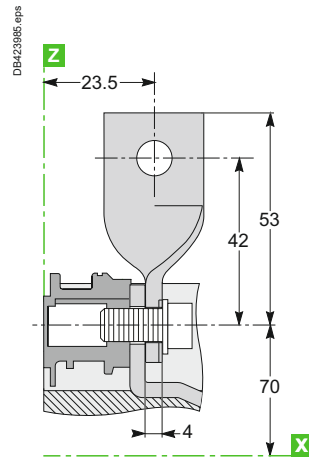
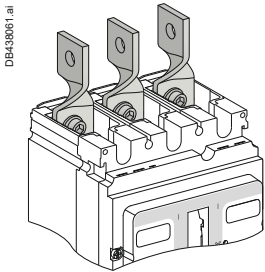

45° Terminal Extensions

NSX100 to 250 DC

NSX400/630 DC

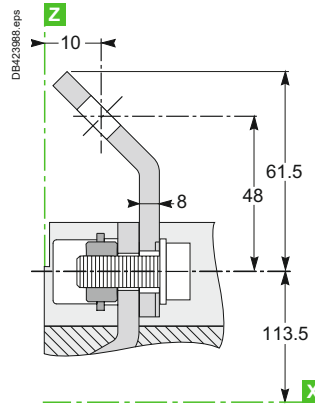
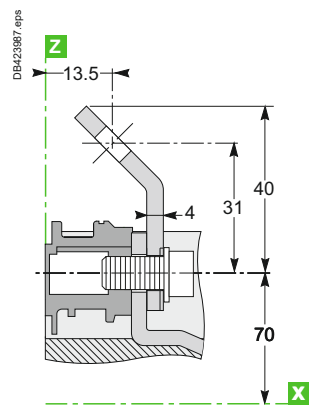
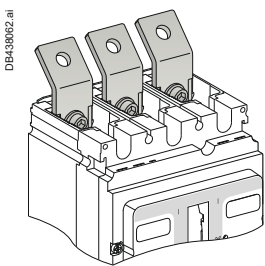

Double-L Terminal Extensions

NSX100 to 250 DC

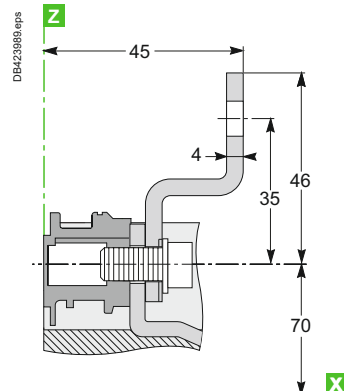
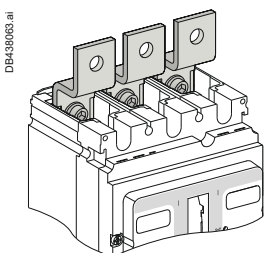

# Dimensions and Connection

## Power Connections

### ComPacT NSX100 to 630 DC Fixed Version

#### Connection with Accessories (Cont.)

Spreaders

3P

4P

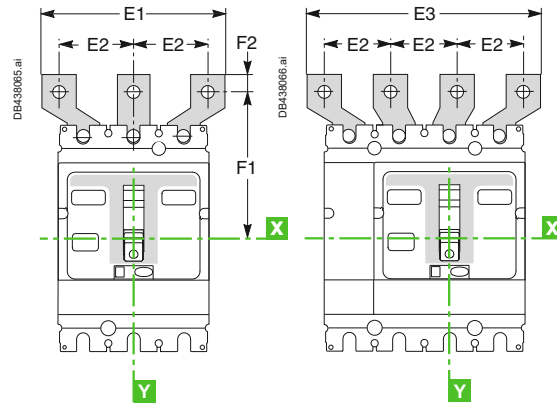
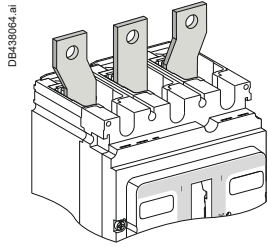

NSX100 to 250 DC

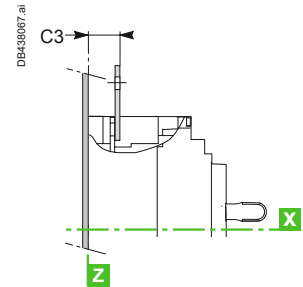

NSX400/630 DC

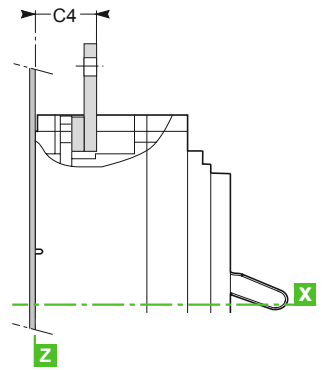

Type	C3	C4	E1	E2	E3	F1	F2
NSX100/160 DC	23.5	-	114	45	159	100	11
NSX250 DC/PV/EP	25.5	-	114	45	159	100	11
NSX400/630 DC	-	44	135	52.5	187.5	152.5	15
			170	70	240	166	15

#### One-Piece Spreader (for NSX100 to 250 Only)

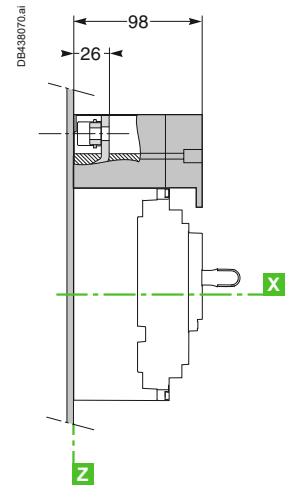
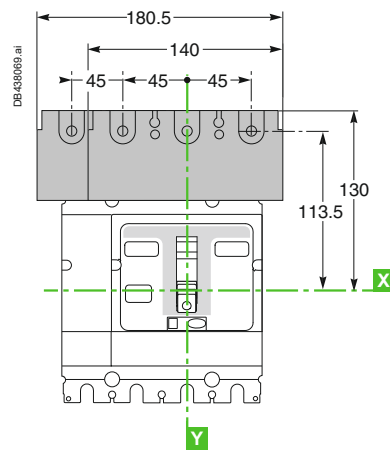
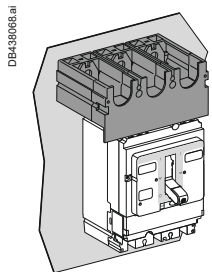



# Dimensions and Connection

## Power Connections

### Connection of Insulated Bars or Cables with Lugs to ComPacT NSX100 to 1200 DC

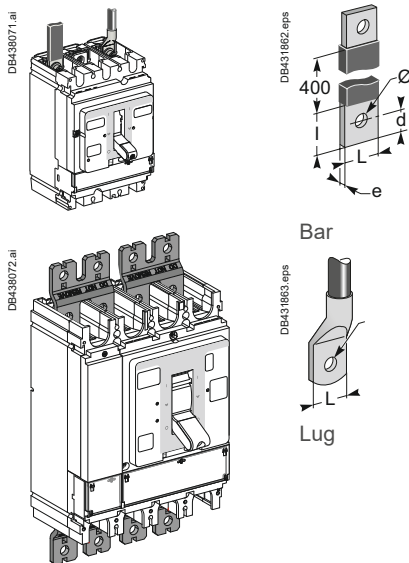

#### Direct Connection to NSX100 to 1200 DC

Dimensions		NSX100 DC	NSX160/250 DC	NSX400/630/1200 DC
<b>Bars</b>	L (mm)	≤ 25	≤ 25	≤ 32
	l (mm)	d + 10	d + 10	d + 15
	d (mm)	≤ 10	≤ 10	≤ 15
	e (mm)	≤ 6	≤ 6	3 ≤ e ≤ 10
	Ø (mm)	6.5	8.5	10.5
<b>Lugs</b>	L (mm)	≤ 25	≤ 25	≤ 32
	Ø (mm)	6.5	8.5	10.5
<b>Torque (Nm) [1]</b>		10	15	50
<b>Torque (Nm) [2]</b>		5/5	5/5	20/11
<b>Torque (Nm) [3]</b>		8	8	20

[1] Tightening torque on the circuit breaker for lugs or bars.

[2] Tightening torque on fixed devices for rear connectors//tightening torque on plug-in or withdrawable devices for power connectors.

[3] Tightening torque on the plug-in base for terminal extensions.

#### Connection with Accessories to NSX100 to 250 DC (IEC 228)

Pole Pitch			
Without spreaders		35 mm	
With spreaders		45 mm	
Dimensions		With Spreaders or Terminal Extensions	
		NSX100 DC	NSX160/250 DC
<b>Bars</b>	L (mm)	≤ 25	≤ 25
	l (mm)	20 ≤ l ≤ 25	20 ≤ l ≤ 25
	d (mm)	≤ 10	≤ 10
	e (mm)	≤ 6	≤ 6
	Ø (mm)	6.5	8.5
<b>Lugs</b>	L (mm)	≤ 25	≤ 25
	Ø (mm)	6.5	8.5
<b>Torque (Nm) [1]</b>		10	15
<b>Torque (Nm) [2]</b>		5	5

[1] Tightening torque on the circuit breaker for spreaders or terminal extensions.

[2] Tightening torque on the plug-in base for spreaders or terminal extensions.

Spreaders and straight, right-angle, 45°, double-L and edgewise terminal extensions are supplied with flexible interphase barriers.

#### Accessories for NSX100 to 250 DC

Straight Terminal Extensions      Double-L Terminal Extensions



Tinned copper      Tinned copper

Separators      One-piece spreader

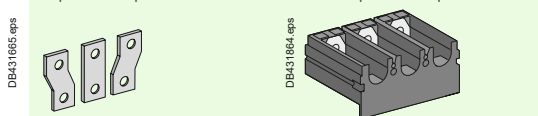

Tinned copper  
For U > 600 V, the mandatory insulation kit is not compatible with spreaders made up of separate parts.

#### Accessories for NSX400 and 630 DC Spreaders Made up of Separate Parts for 52.5 and 70 Mm Pitch



Tinned copper  
For U > 600 V, use of the 52.5 mm pitch spreaders requires a specific insulation kit.  
The 70 mm pitch spreaders may not be used.

#### Accessories for NSX100 to 630 DC Right-Angle Terminal Extensions      Edgewise Terminal Extensions

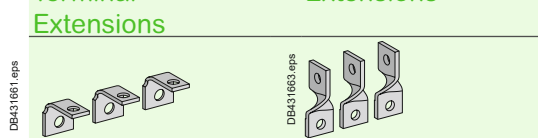

Tinned copper      Tinned copper

To be mounted on upstream side  
**45° Terminal Extensions**



Tinned copper

#### Connection with Accessories to NSX400 DC and 630 DC (IEC 228)

Pole Pitch			
Without spreaders		45 mm	
With spreaders		52.5 or 70 mm	
Dimensions		With Spreaders	With Terminal Extensions
<b>Bars</b>	L (mm)	≤ 40	≤ 32
	l (mm)	d + 15	30 ≤ l ≤ 34
	d (mm)	≤ 20	≤ 15
	e (mm)	3 ≤ e ≤ 10	3 ≤ e ≤ 10
	Ø (mm)	12.5	10.5
<b>Lugs</b>	L (mm)	≤ 40	≤ 32
	Ø (mm)	12.5	10.5
<b>Torque (Nm) [1]</b>		50	50
<b>Torque (Nm) [2]</b>		20	20

[1] Tightening torque on the circuit breaker for spreaders or terminal extensions.

[2] Tightening torque on the plug-in base for spreaders or terminal extensions.

Spreaders and right-angle, 45° and edgewise terminal extensions are supplied with flexible interphase barriers.

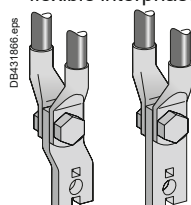

Mounting detail: 2 cables with lugs

Connection of Bare Cables to ComPacT NSX100 to 1200 DC

Connection for NSX100 to 250 DC

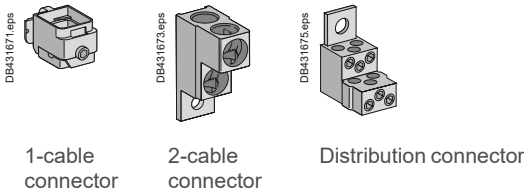

	1-cable connector	Steel ≤ 160 A	Aluminium ≤ 250 A	
DB431867.eps 	L (mm)	25	25	
	S (mm <sup>2</sup> ) Cu/Al	1.5 to 95 <sup>[1]</sup>	25 to 50	70 to 95 120 to 185 150 max. flex.
	Torque (Nm)	12	20	26 26
	2-cable connector			
DB431867.eps 	L (mm)	25 or 50		
	S (mm <sup>2</sup> ) Cu/Al	2 x 50 to 2 x 120		
	Torque (Nm)	22		
	6-cable distribution connector (copper or aluminium)			
DB431867.eps 	L (mm)	15 or 30		
	S (mm <sup>2</sup> ) Cu/Al	1.5 to 6 <sup>[1]</sup>	8 to 35	
	Torque (Nm)	4	6	

[1] For flexible cables from 1.5 to 4 mm<sup>2</sup>, connection with crimped or self-crimping ferrules.

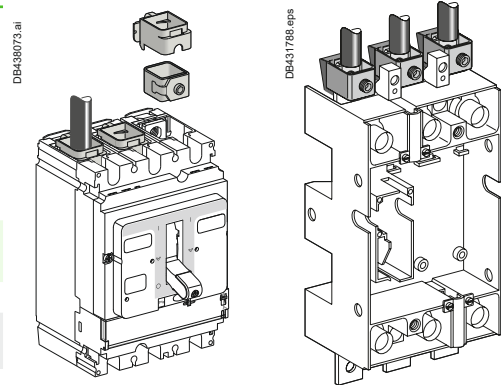

Connection for NSX400 and 630 DC

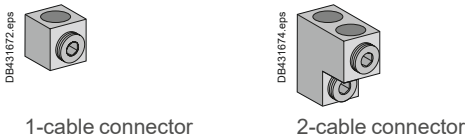

	1-cable connector	1-cable connector	2-cable connector
DB431867.eps 	L (mm)	30	30 or 60
	S (mm <sup>2</sup> ) Cu/Al	35 to 300 rigid 240 max. flex.	2 x 35 to 2 x 240 rigid 240 max. flex.
	Torque (Nm)	31	31

Connection for NSX630 and 1200 DC

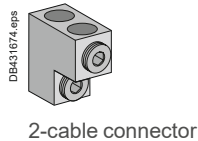

	2-cable connector	2-cable connector
DB431867.eps 	L (mm)	30 or 60
	S (mm <sup>2</sup> ) Cu/Al	2 x 35 to 2 x 240 rigid 240 max. flex.
	Torque (Nm)	31

Conductor Materials and Electrodynamic Stresses

ComPacT NSX DC circuit breakers can be connected indifferently with bare-copper, tinned-copper and tinned-aluminium conductors (flexible or rigid bars, cables). In the event of a short-circuit, thermal and electrodynamic stresses will be exerted on the conductors. They must therefore be correctly sized and held in place by supports.

Electrical connection points on switchgear devices (switch-disconnectors, contactors, circuit breakers, etc.) should not be used for mechanical support. Any partition between upstream and downstream connections of the device must be made of non-magnetic material.

# ComPacT (Fixed Version) 2P-3P-4P

## Parallel and Series Connection of Poles

### ComPacT NSX100 to NSX250 DC

#### 2P Fixed Version (ComPacT NSX100-160 N/H DC) - 3P Fixed Version (ComPacT NSX100-250 DC)

With Series Connections

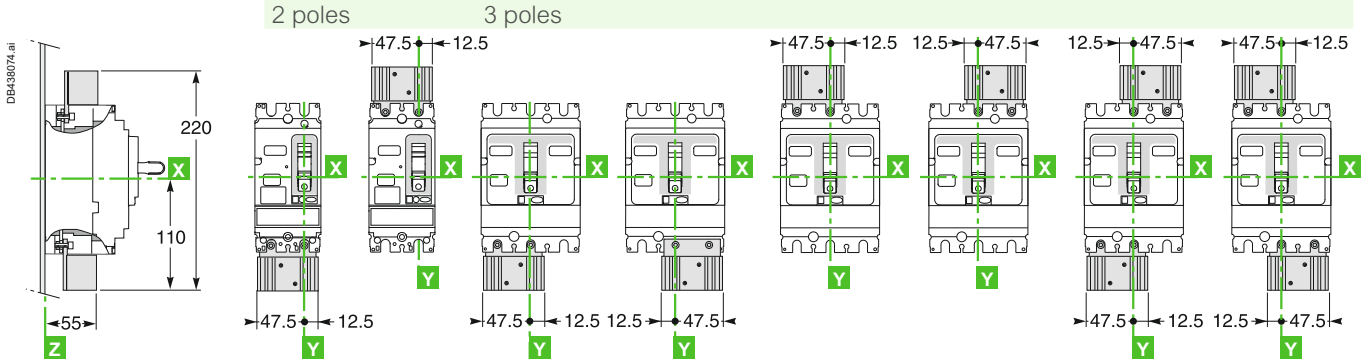

With Parallel Connections

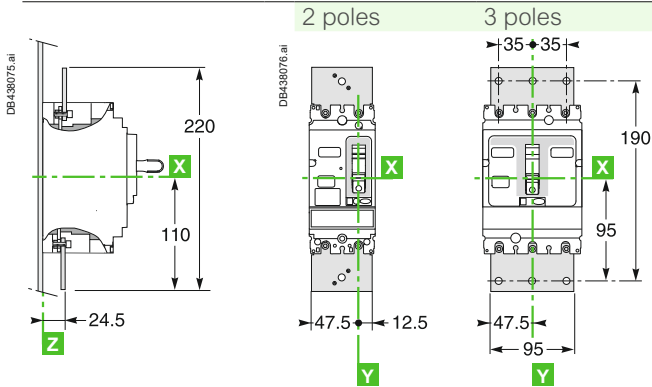

#### 4P Fixed Version (ComPacT NSX100-250 DC)

With Series Connections

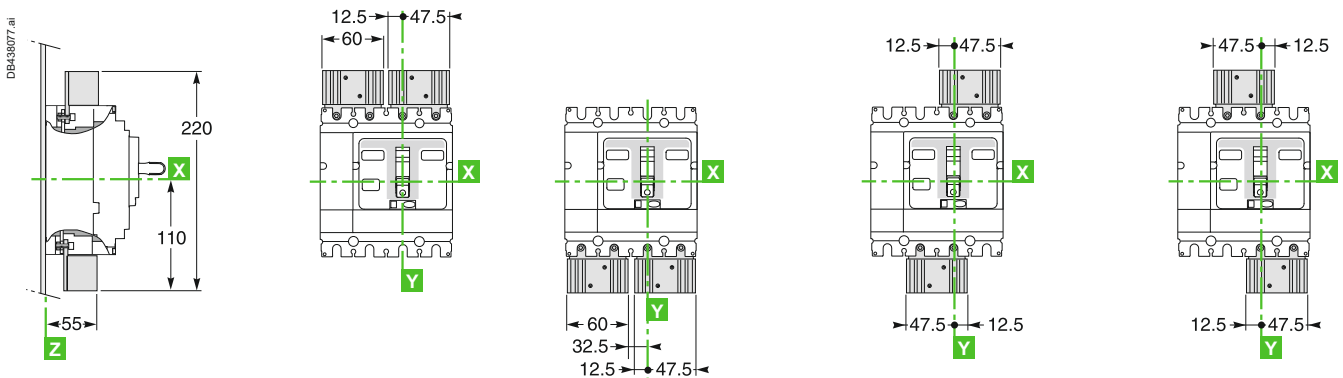

With Parallel Connections

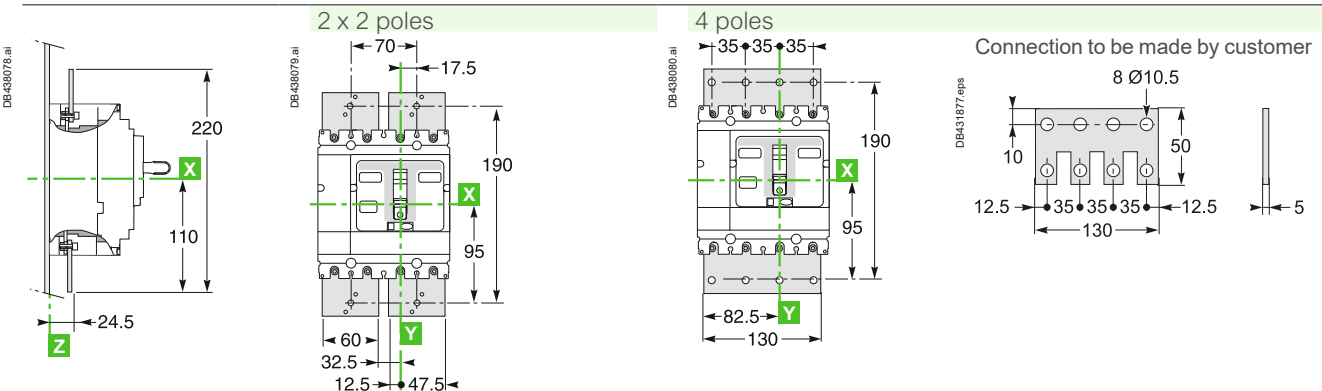

# ComPacT (Fixed Version) 2P-3P-4P Parallel and Series Connection of Poles ComPacT NSX400 to NSX630 DC

## 3P Fixed Version (ComPacT NSX400-630 DC) With Series Connections

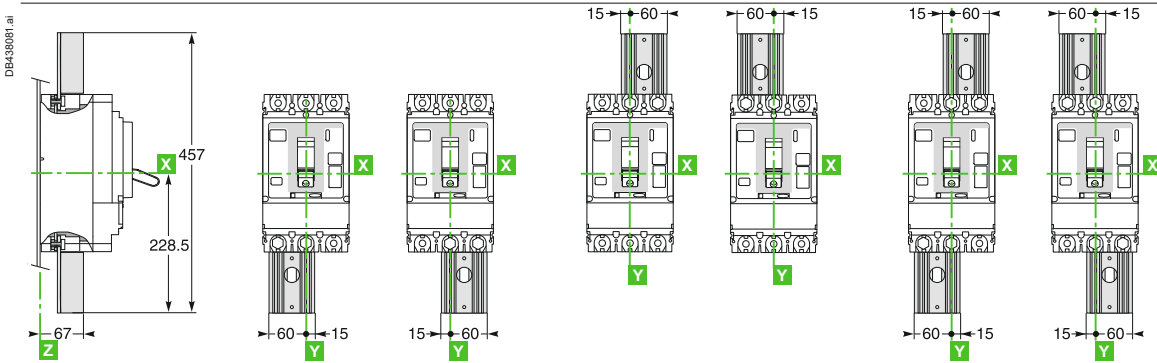

## With Parallel Connections

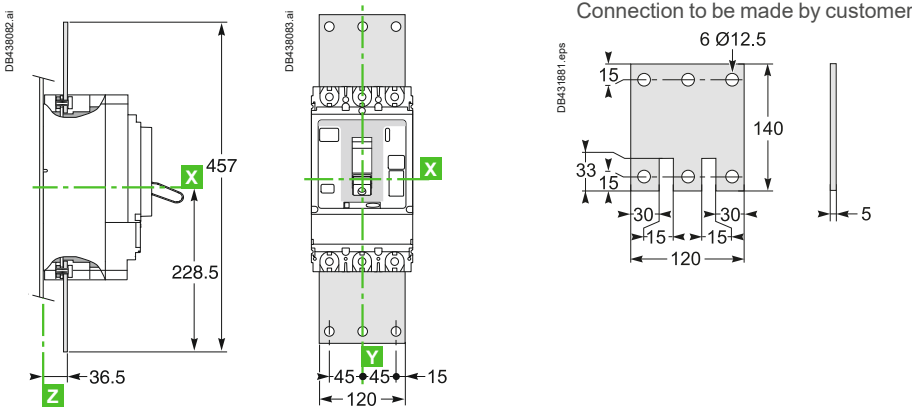

## 4P Fixed Version (ComPacT NSX400 to NSX630 DC) With Series Connections

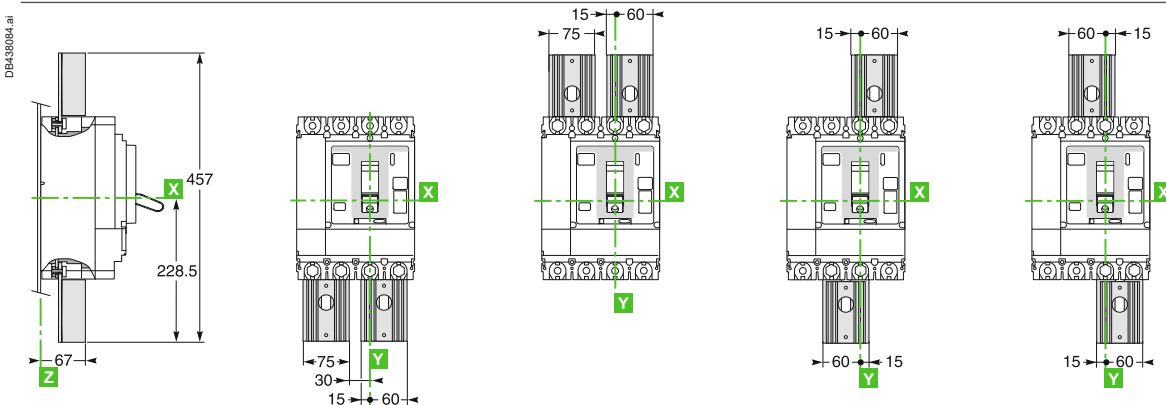

## With Parallel Connections

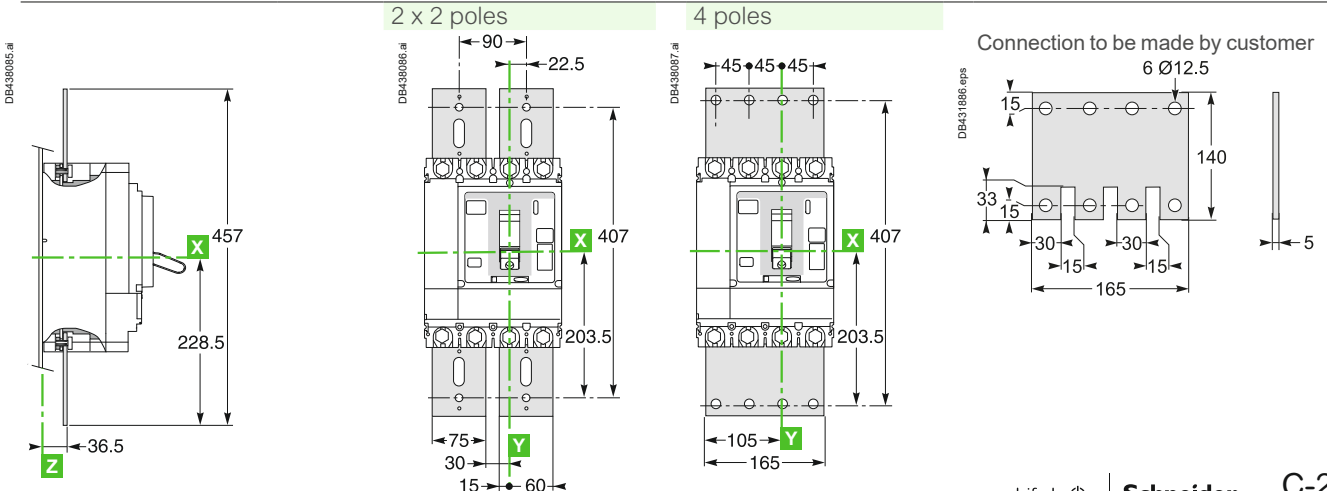

## Dimensions and Connection

# ComPacT (Fixed Version) 4P Parallel and Series Connection of Poles ComPacT NSX630 to NSX1200 DC

### 4P Fixed Version (ComPacT NSX630 to NSX1200DC) With Parallel Connections

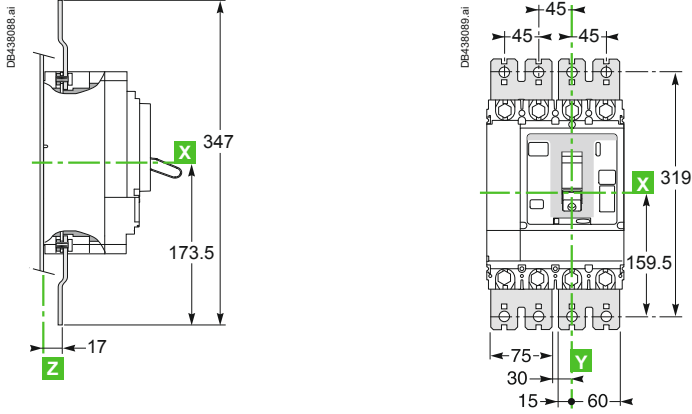

# ComPacT (Withdraw. Version) 3P-4P Parallel and Series Connection of Poles ComPacT NSX100 to NSX250 DC

## 3P Withdrawable Version

### Connections Mounted with Heat Sink Directed Outwards

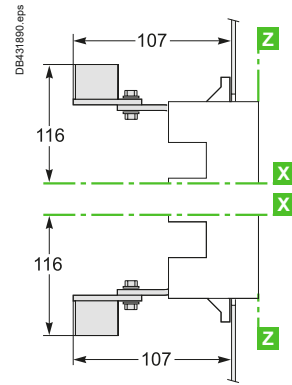
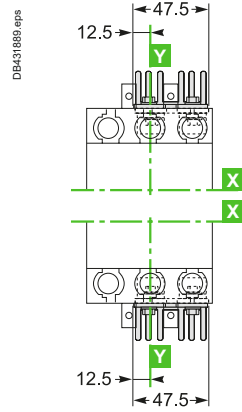
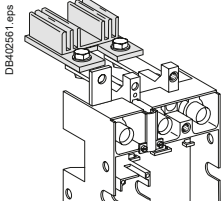

### Connections Mounted with Heat Sink Directed Inwards

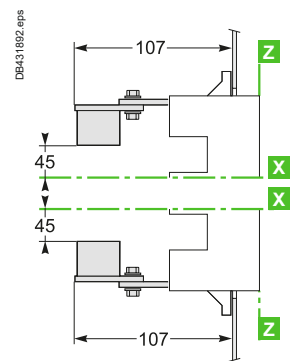
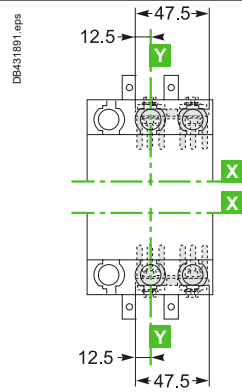
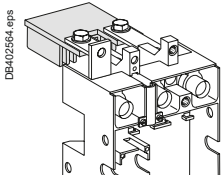

## 4P Withdrawable Version

### Connections Mounted with Heat Sink Directed Outwards

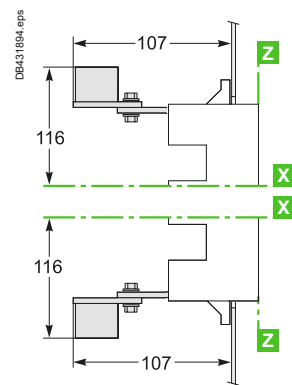
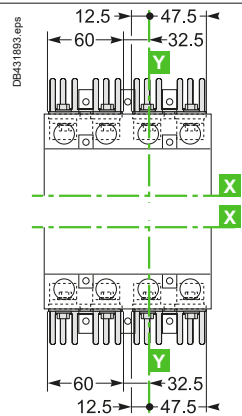
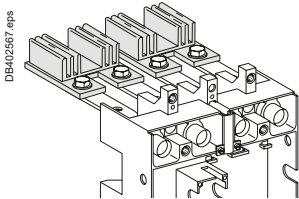

### Connections Mounted with Heat Sink Directed Inwards

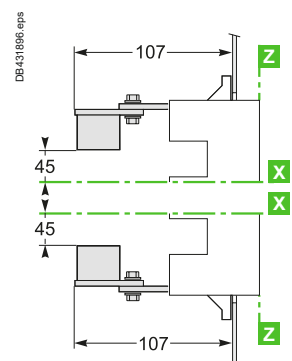
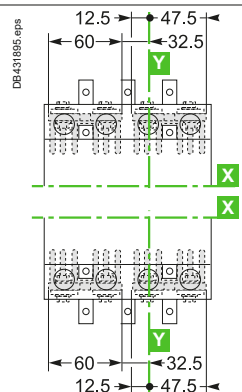
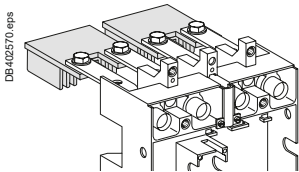

# ComPacT (Withdraw. Version) 3P-4P Parallel and Series Connection of Poles ComPacT NSX400 to NSX630 DC

## 3P Withdrawable Version

### Connections Mounted with Heat Sink Directed Outwards

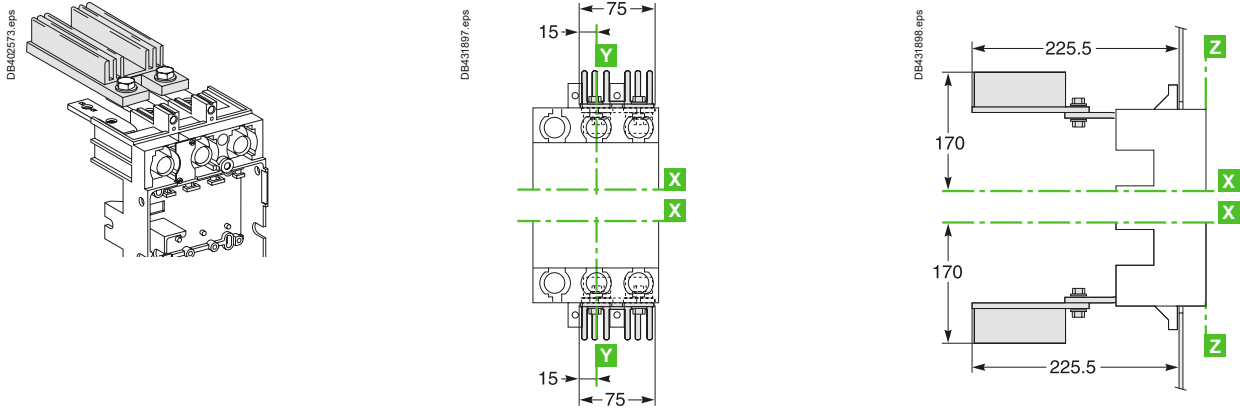

### Connections Mounted with Heat Sink Directed Inwards

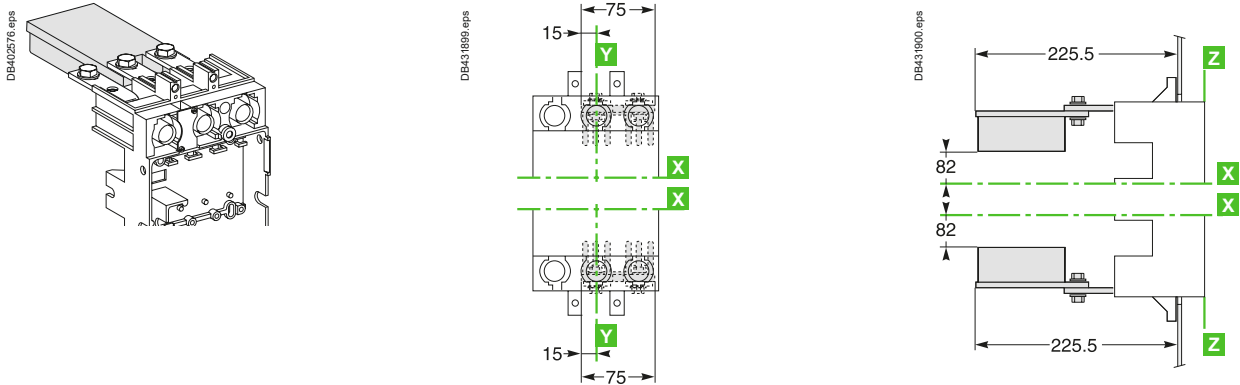

## 4P Withdrawable Version

### Connections Mounted with Heat Sink Directed Outwards

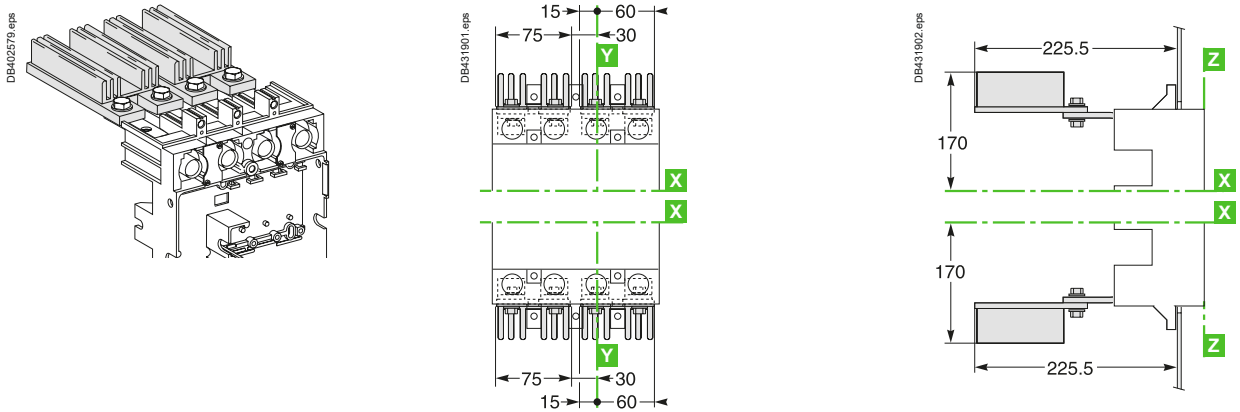

### Connections Mounted with Heat Sink Directed Inwards

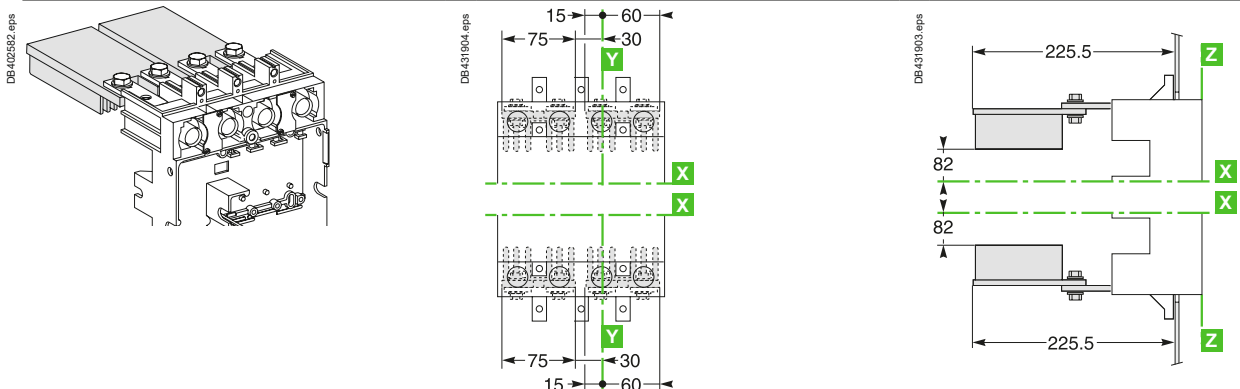



# ComPacT (Fixed Version)

## 4P Connection of Poles, Dimensions and Mounting

### ComPacT NSX100 to NSX630 DC PV - DC EP

#### 4P Fixed Version (ComPacT NSX100-200 DC PV)

With Series Connections

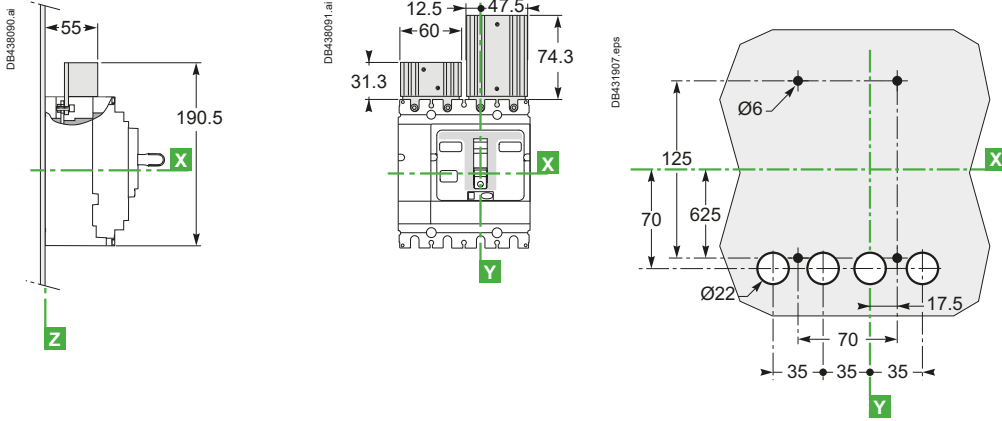

#### 4P Fixed Version (ComPacT NSX250-630 DC PV)

With Series Connections

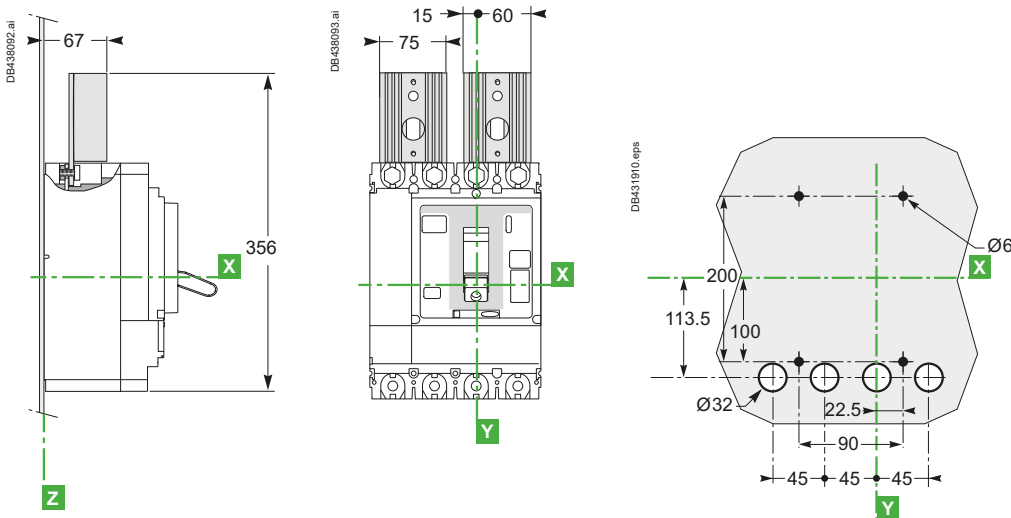

#### Dimensions

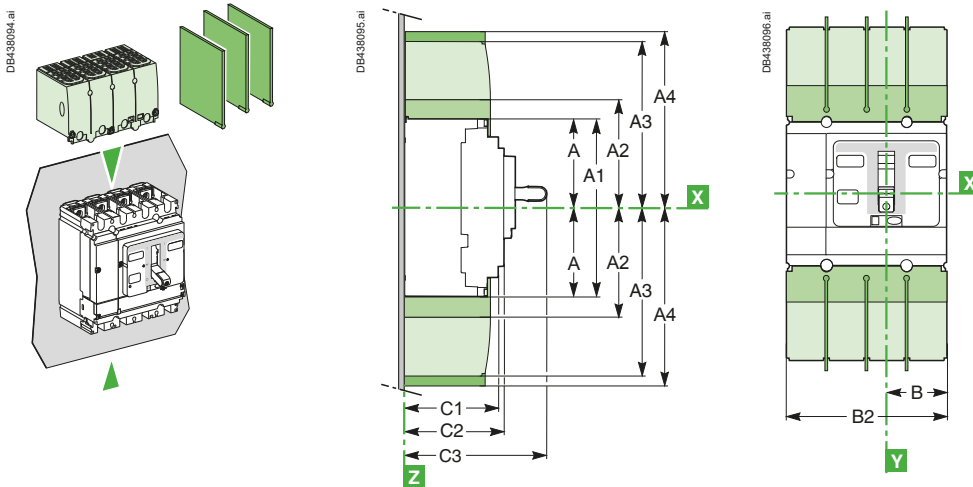

Interphase barriers  
 Long terminal shields

Long terminal shields (also available for NSX400/630 DC spreaders with 52.5 mm pitch: B2 = 210 mm)

Type	A	A1	A2	A3	A4	B	B2	C1	C2	C3
NSX100/160/200 DC PV	80.5	161	94	145	178.5	52.5	140	81	86	126
NSX250/630 DC PV	127.5	255	142.5	240	237	70	185	95.5	110	168

# ComPacT (Fixed Version)

## 4P Connection of Poles, Dimensions

### ComPacT NSX630b to 1600 DC PV

#### Electrical Control

#### Front Connection

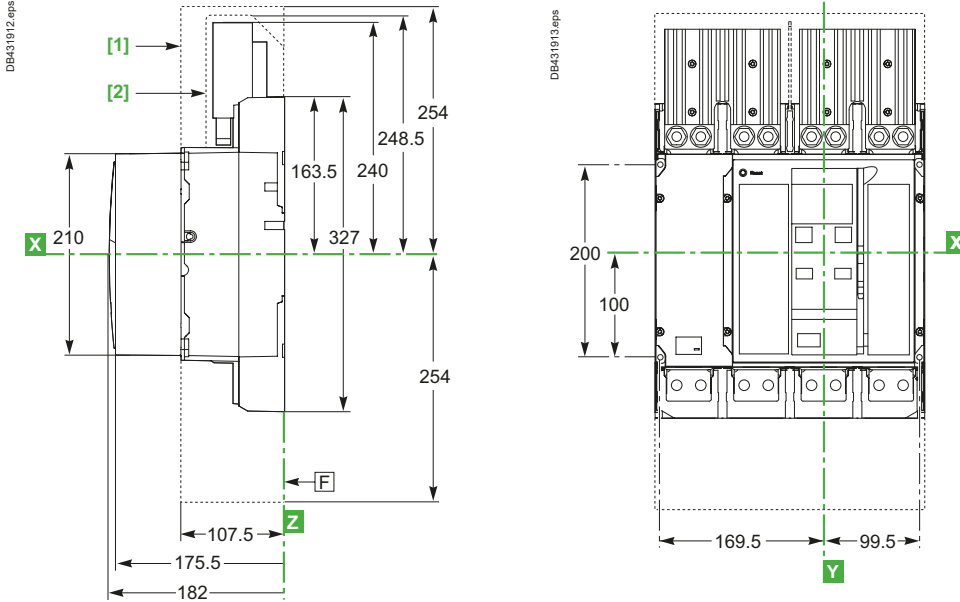

- [1] With terminal shield.
- [2] With phase separator.

#### Rear Connection

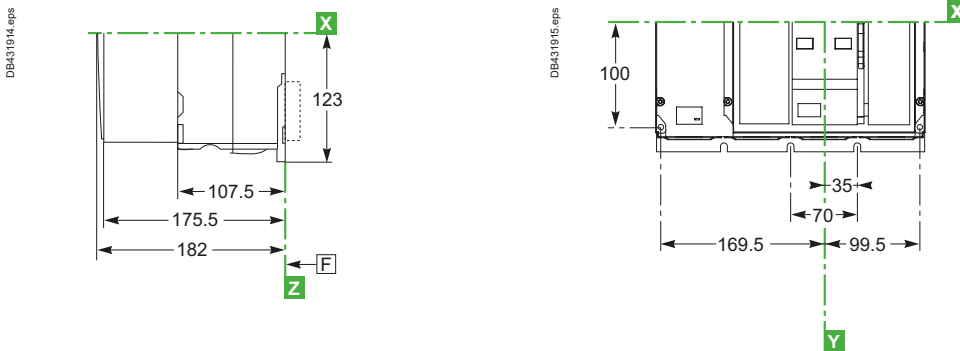

#### Front-Panel Cutouts

#### Door cutout A

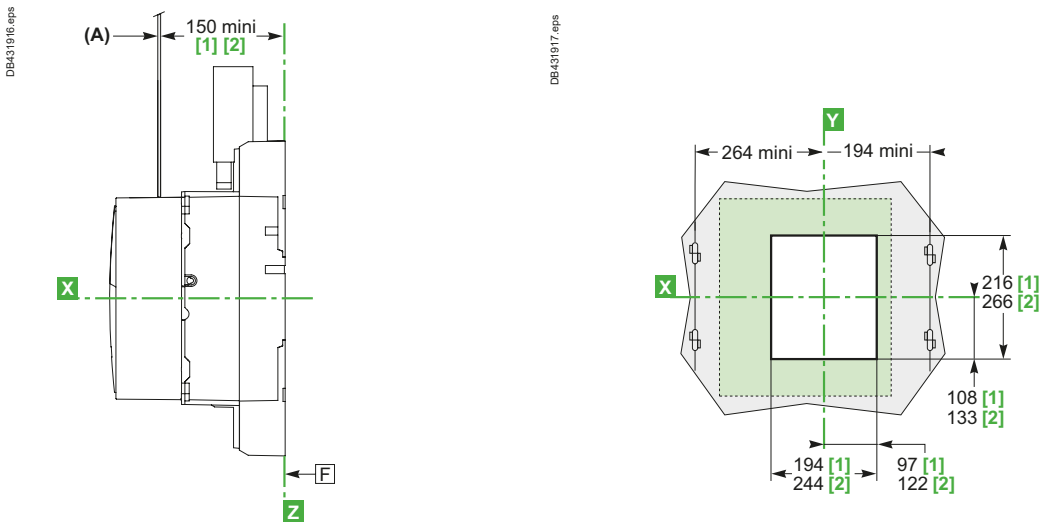

- F: Datum
- [1] Without escutcheon.
- [2] With escutcheon.

# ComPacT (Fixed Version) 4P Front Connection of Poles, Mounting ComPacT NSX630b to 1600 DC PV

## On Backplate

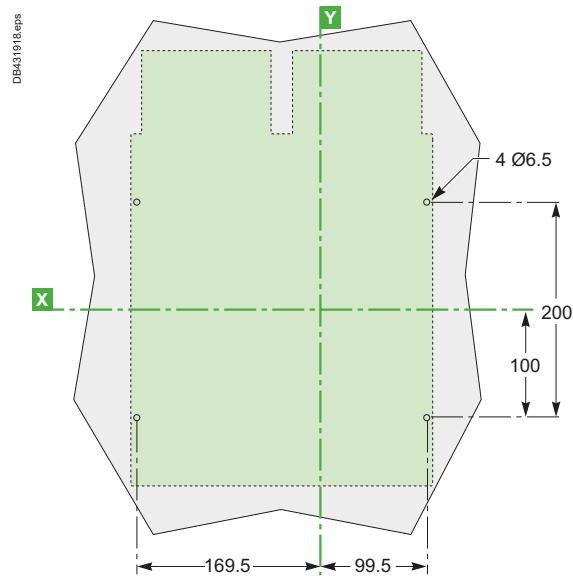

## On Rails

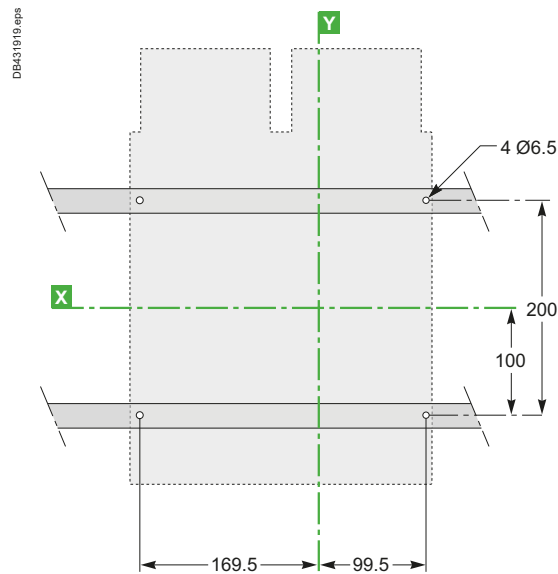

**Note:** Mounting parameters for electrically operated devices are identical to those for manually operated devices.  
**X** and **Y** are the symmetry planes for a 4-pole device.  
**Z** is the back plane of the device.

# ComPacT (Fixed Version)

## 4P Rear Connection of Poles, Mounting

### ComPacT NSX630b to 1600 DC PV

#### On Backplate

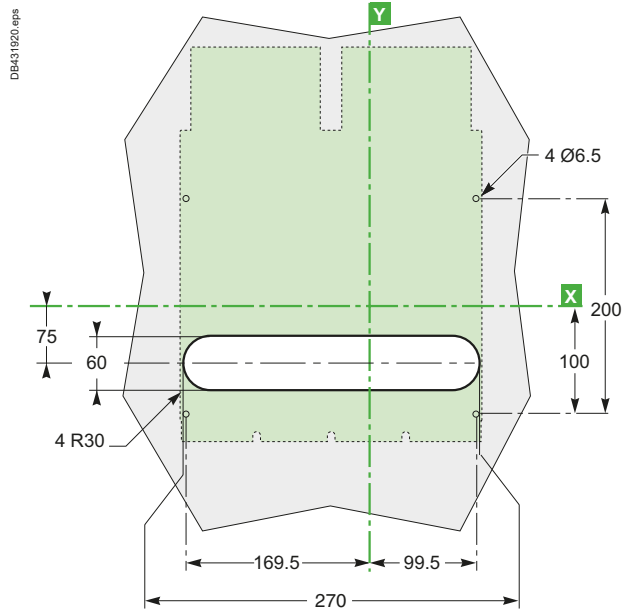

#### On Rails

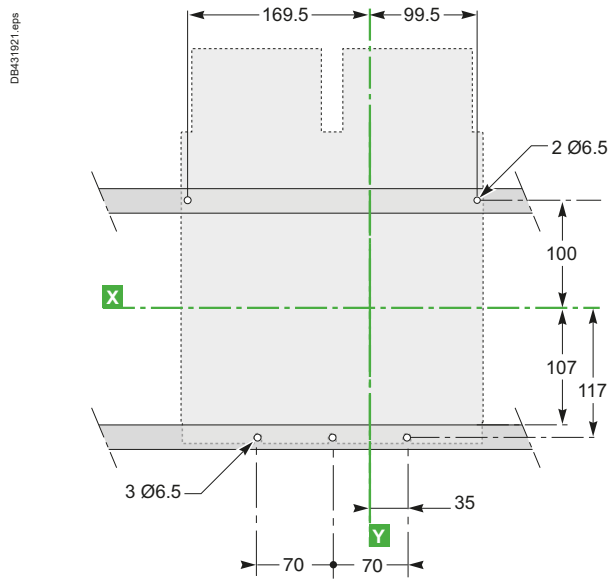

**Note:** Mounting parameters for electrically operated devices are identical to those for manually operated devices.  
**X** and **Y** are the symmetry planes for a 4-pole device.  
**Z** is the back plane of the device.

# MasterPact (Fixed Device)

NW10 to 40 DC Version C/D (3P),  
Version E (4P) NW10 to 40 EPDC, DC PV Version D (3P)

## Device

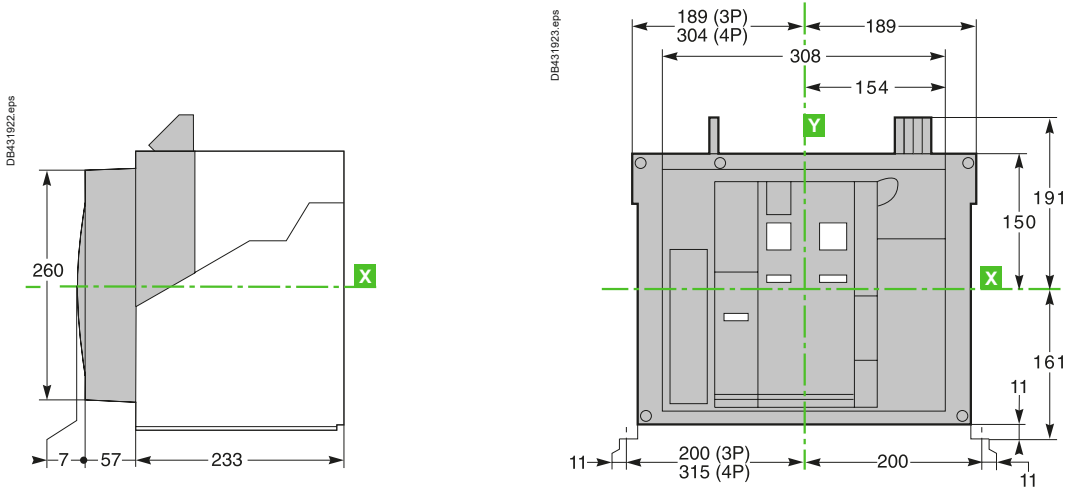

## Mounting on Base Plate or Rails

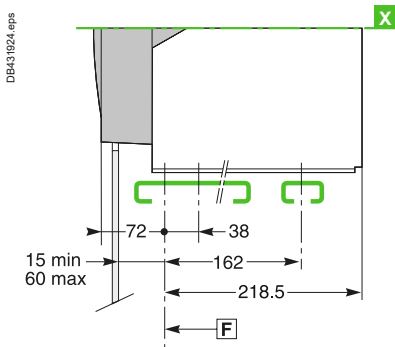

## Mounting Detail

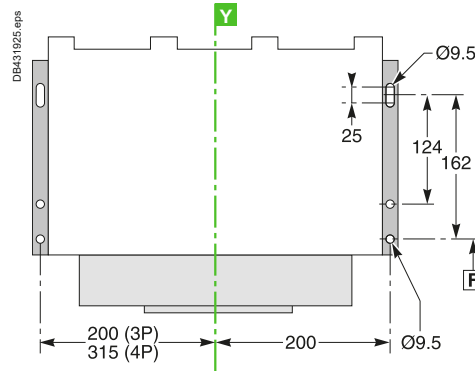

## Safety Clearances

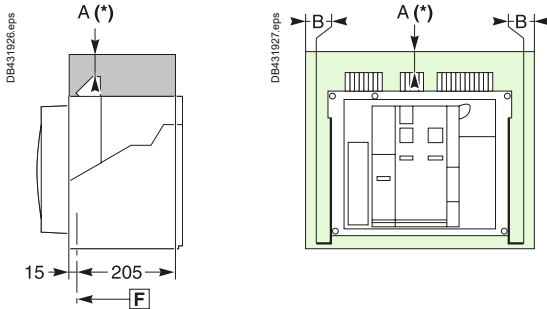

## Door Cutout

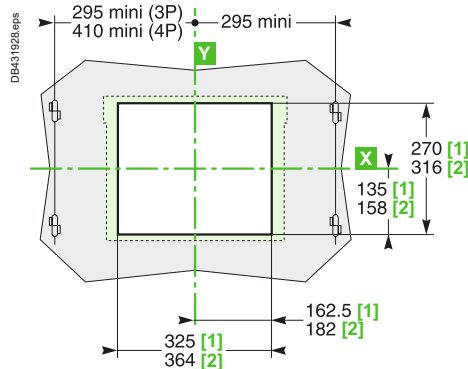

	Insulated parts	Metal parts	Energized parts
A	0	0	100
B	0	0	60

**Note:**

[1] Without escutcheon.

[2] With escutcheon.

X and Y are the symmetry planes for a 3-pole device.

A(\*) An overhead clearance of 110 mm is required to remove the arc chutes.

An overhead clearance of 20 mm is required to remove the terminal block.

F: Datum



# MasterPact (Fixed Device) NW10 to 40 DC-Version C

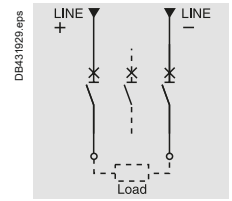

## Connections

### Horizontal Rear Connection (NW10–NW20 DC)

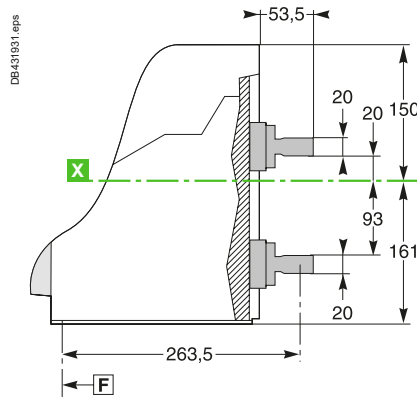
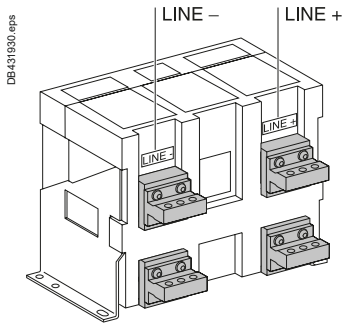

### Detail

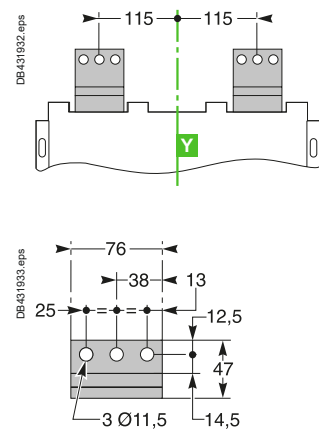

### Vertical Rear Connection (NW10–NW20 DC)

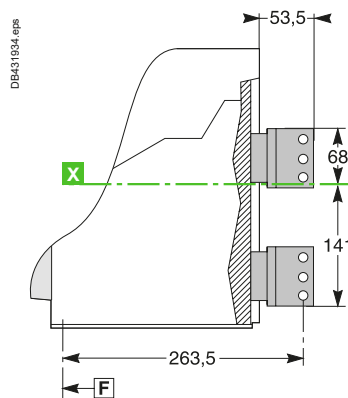
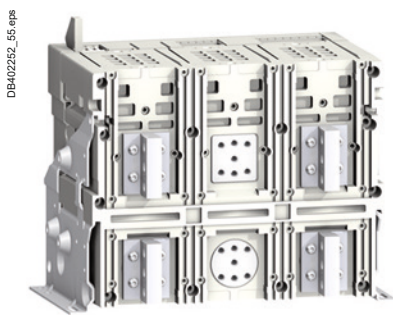

### Detail

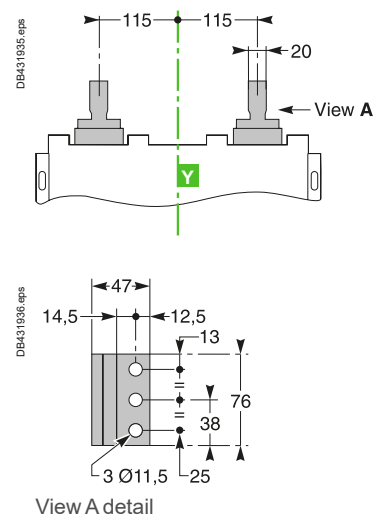

### Vertical Rear Connection (NW40 DC)

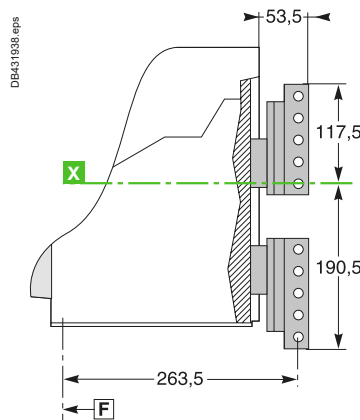
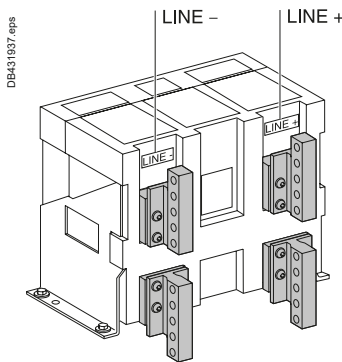

### Detail

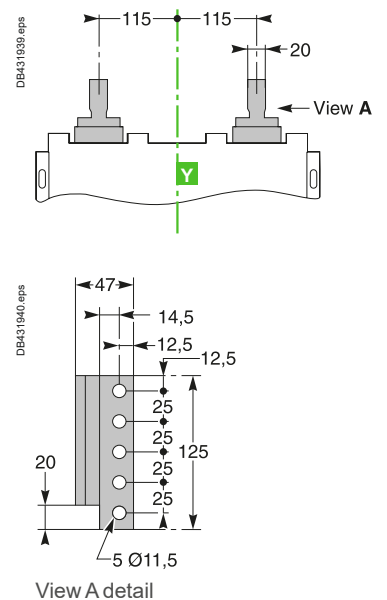

**Note:** Recommended connection screws: M10 class 8.8.  
Tightening torque: 50 Nm with contact washer.

# Dimensions and Connection MasterPact (Fixed Device) NW10 to 40 DC-DC PV-Version D

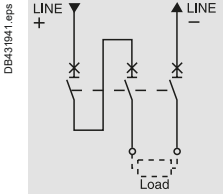

## Connections

### Horizontal Rear Connection (NW10-NW20 DC-DC PV)

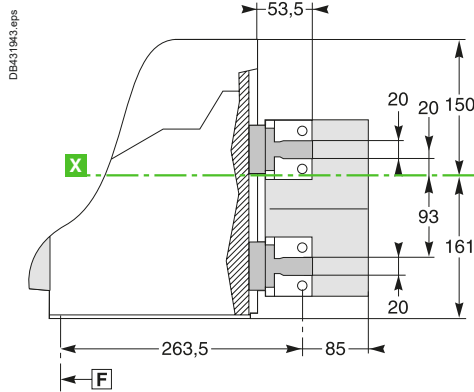
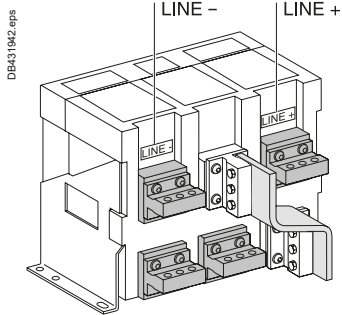

### Detail

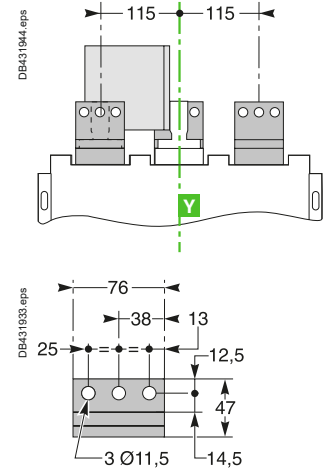

### Vertical Rear Connection (NW10-NW20 DC-DC PV)

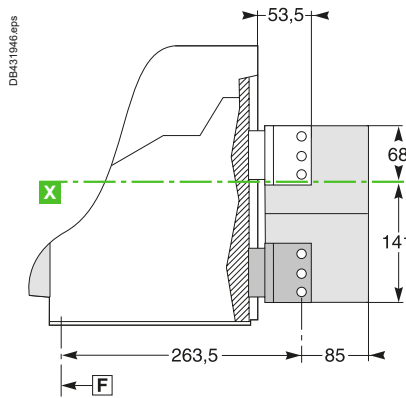
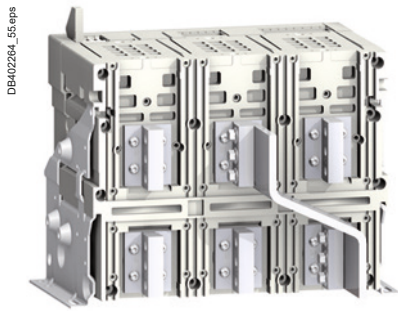

### Detail

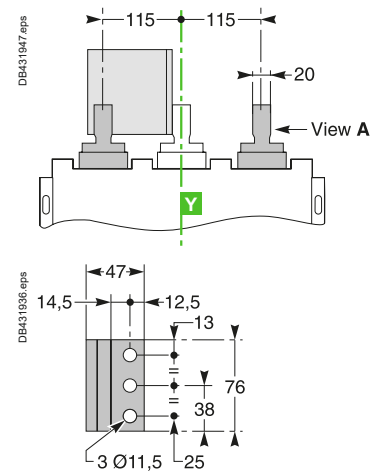

View A detail

### Vertical Rear Connection (NW40 DC-DC PV)

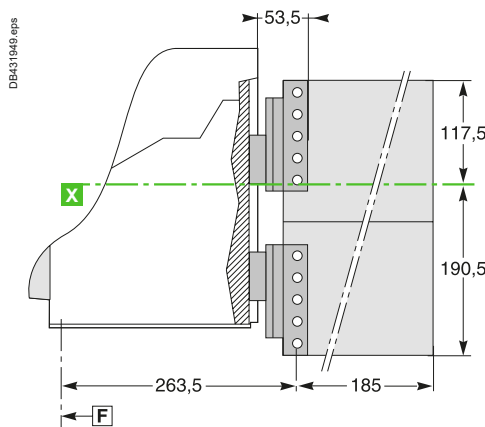
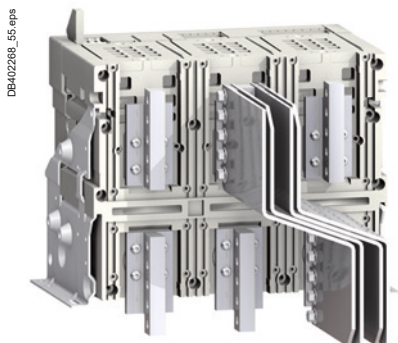

### Detail

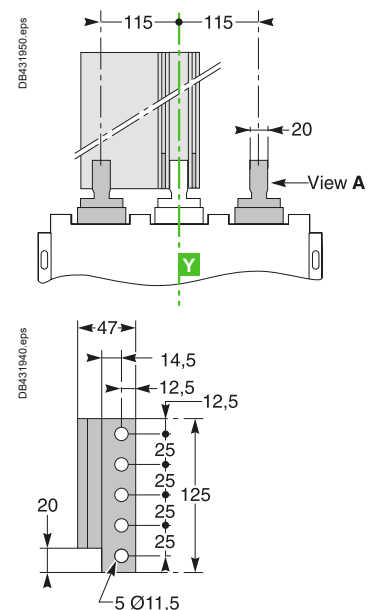

View A detail

**Note:** Recommended connection screws: M10 class 8.8.  
Tightening torque: 50 Nm with contact washer.





# MasterPact (Fixed Device) NW10 to 40 DC-Version E

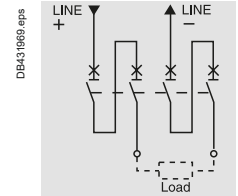

## Connections

### Horizontal Rear Connection (NW10–NW20 DC)

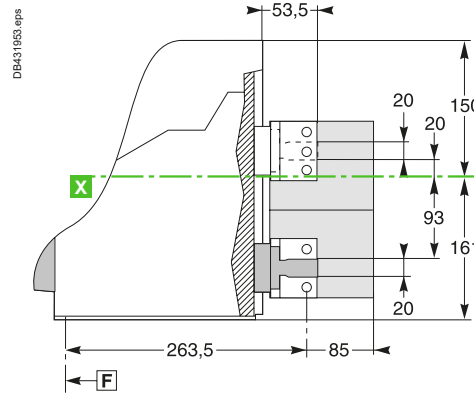

### Detail

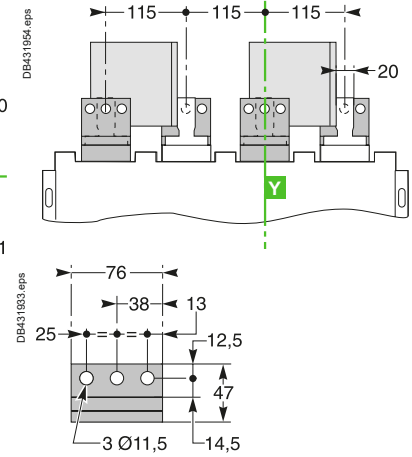

### Vertical Rear Connection (NW10–NW20 DC)

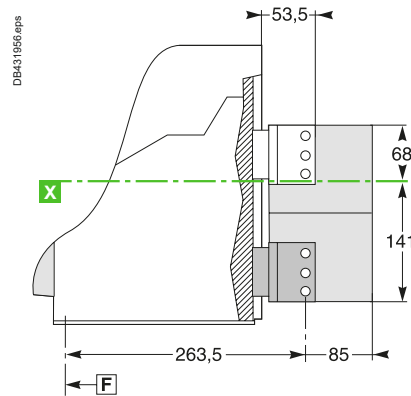
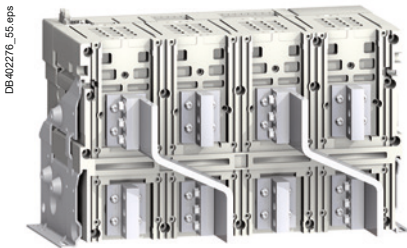

### Detail

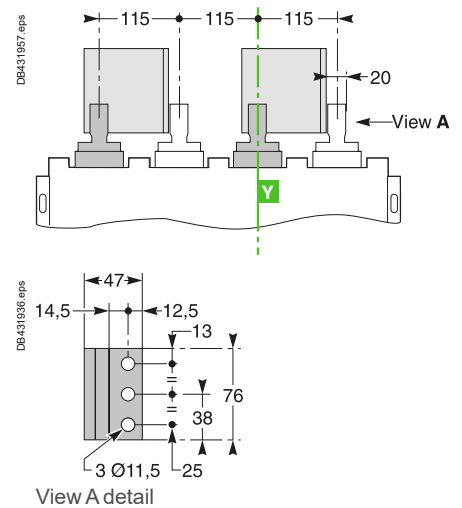

### Vertical Rear Connection (NW40 DC)

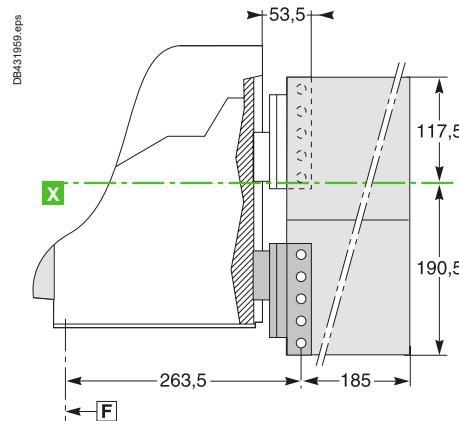
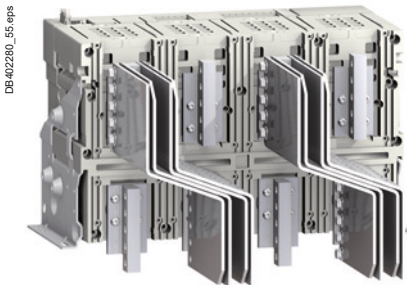

### Detail

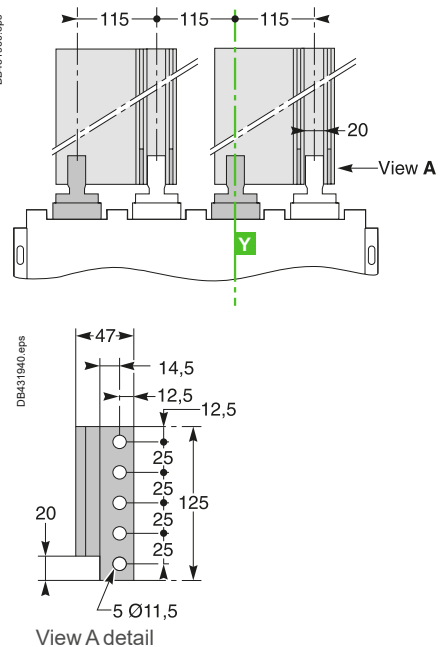

**Note:** Recommended connection screws: M10 class 8.8.  
Tightening torque: 50 Nm with contact washer.

# MasterPact (Drawout Device)

NW10 to 40 DC Version C/D (3P) Version E (4P)  
 NW10 to 40 DC PV Version D (3P)



## Device

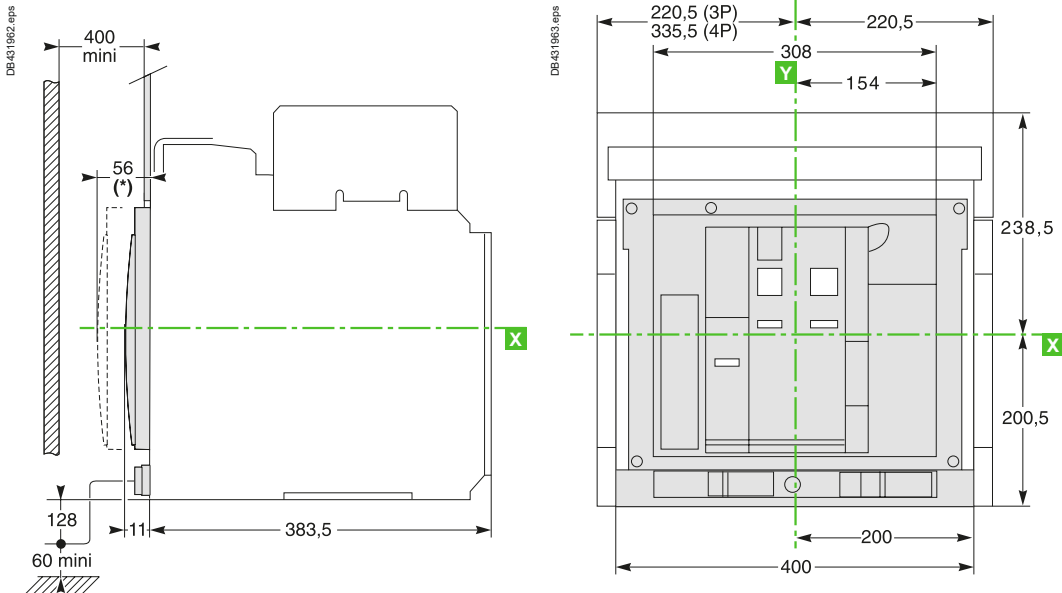

[\*] Drawout position.

## Mounting on Base Plate or Rails

## Mounting Detail

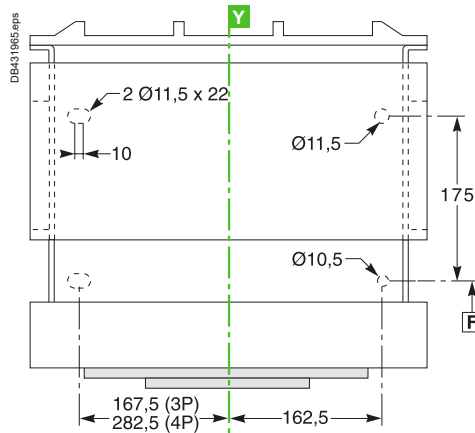
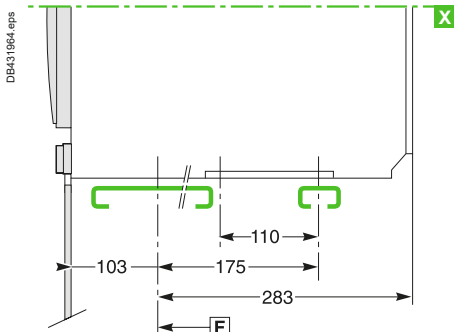

## Safety Clearances

## Door Cutout

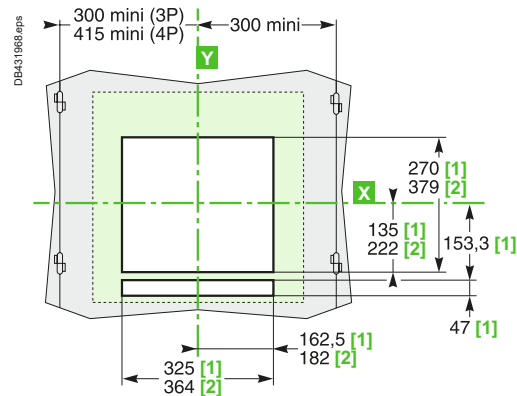
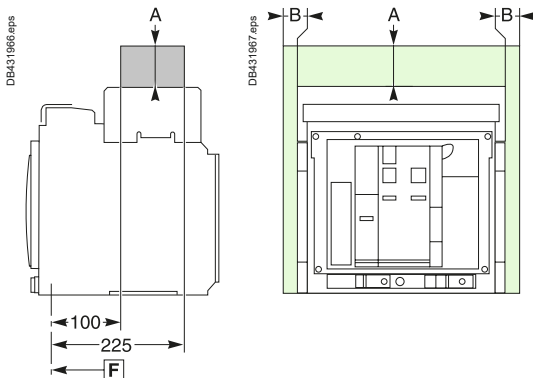

	Insulated parts	Metal parts	Energized parts
A	0	0	0
B	0	0	60

[F]: Datum

Note:

[1] Without escutcheon

[2] With escutcheon

X and Y are the symmetry planes for a 3-pole device.

# MasterPact (Drawout Device) NW10 to 40 DC-Version C

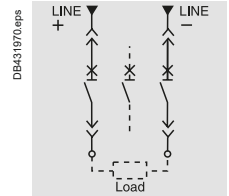

## Connections

### Horizontal Rear Connection (NW10–NW20 DC)

### Detail

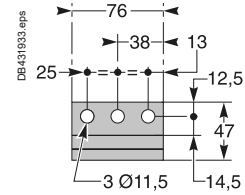
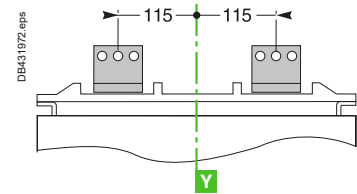
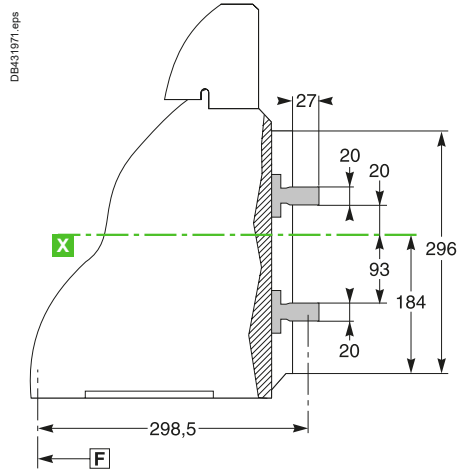
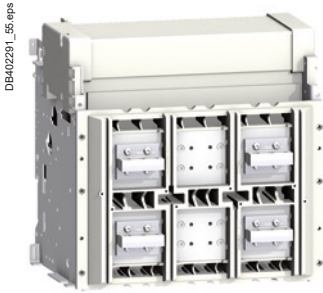

### Vertical Rear Connection (NW10–NW20 DC)

### Detail

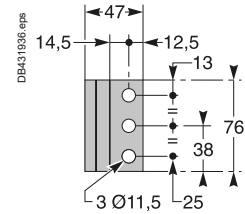
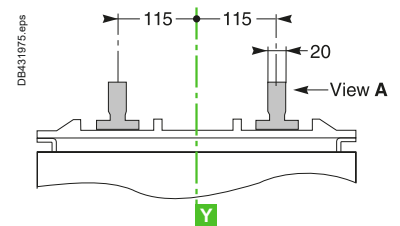
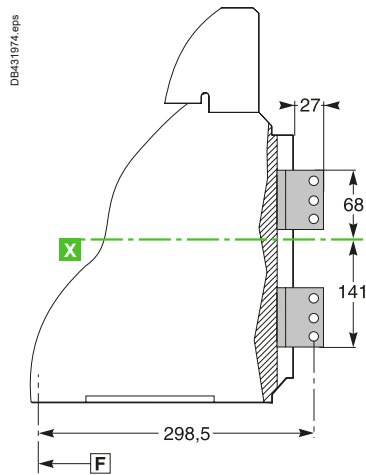
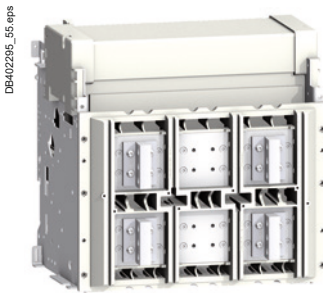

View A detail

### Vertical Rear Connection (NW40 DC)

### Detail

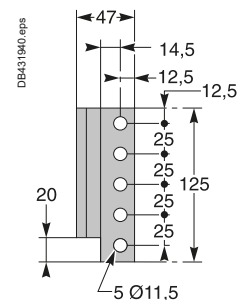
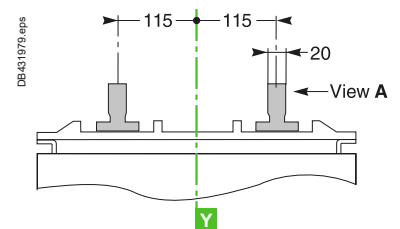
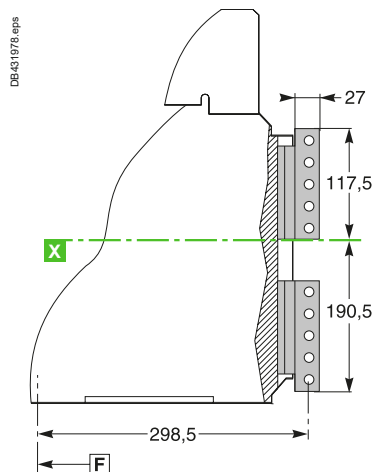
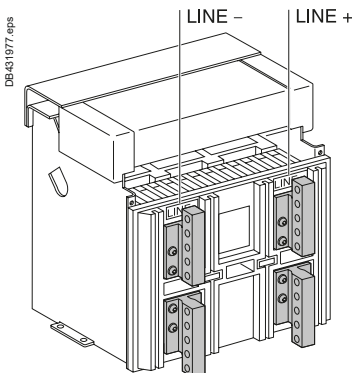

View A detail

**Note:** Recommended connection screws: M10 class 8.8.  
Tightening torque: 50 Nm with contact washer.

# MasterPact (Drawout Device) NW10 to 40 DC, EPDC, DC PV-Version D

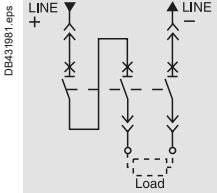

## Connections

### Horizontal Rear Connection (NW10–NW20 DC–DC PV)

### Detail

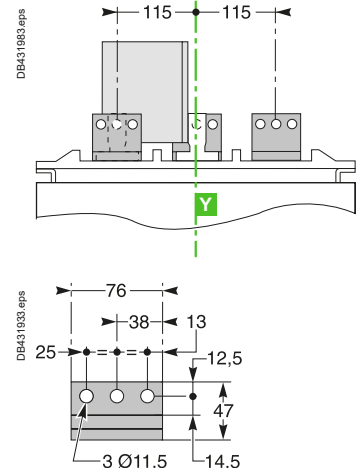
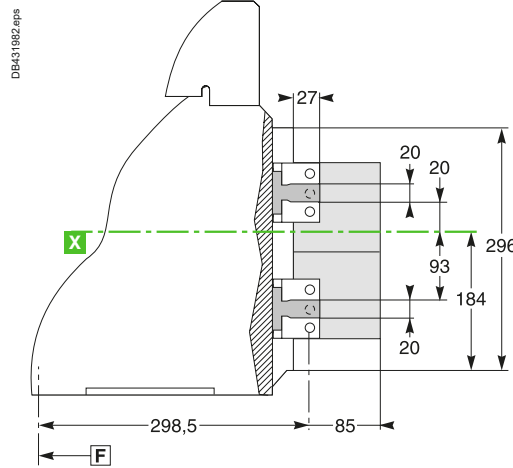
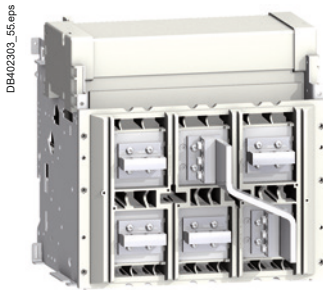

### Vertical Rear Connection (NW10–NW20 DC–DC PV)

### Detail

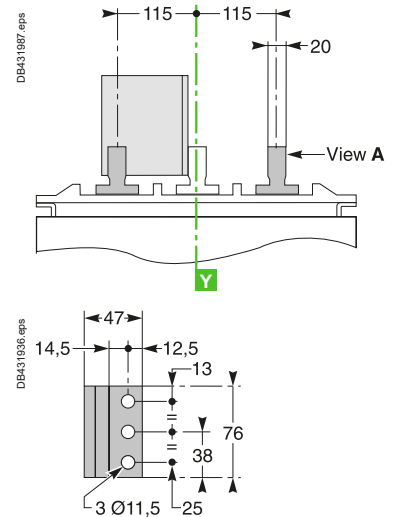
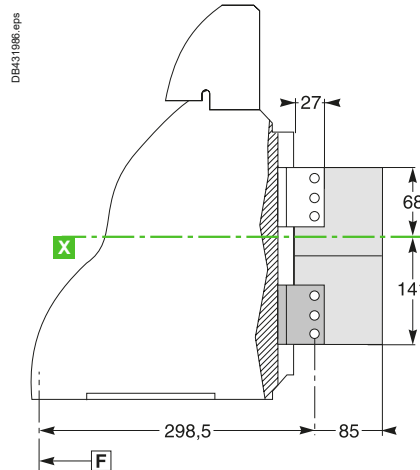
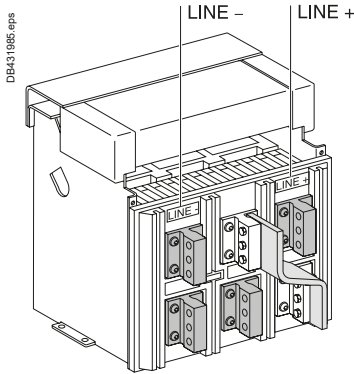

### Vertical Rear Connection (NW40 DC–DC PV)

### Detail

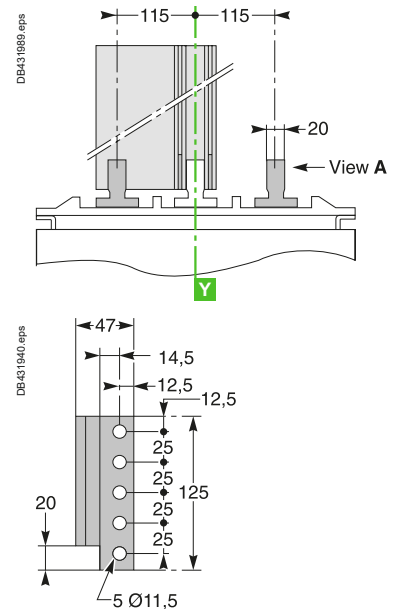
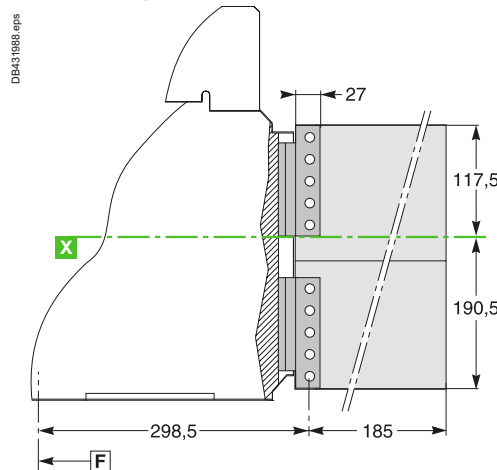
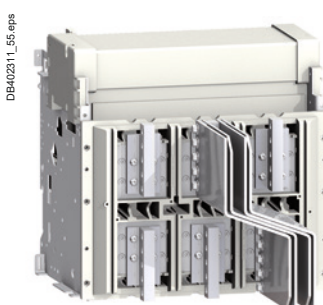

**Note:** Recommended connection screws: M10 class 8.8.  
Tightening torque: 50 Nm with contact washer.



# MasterPact (Drawout Device) NW10 to 40 DC-Version E

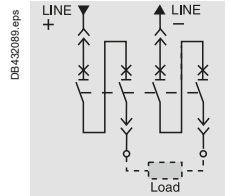

## Connections

### Horizontal Rear Connection (NW10–NW20 DC)

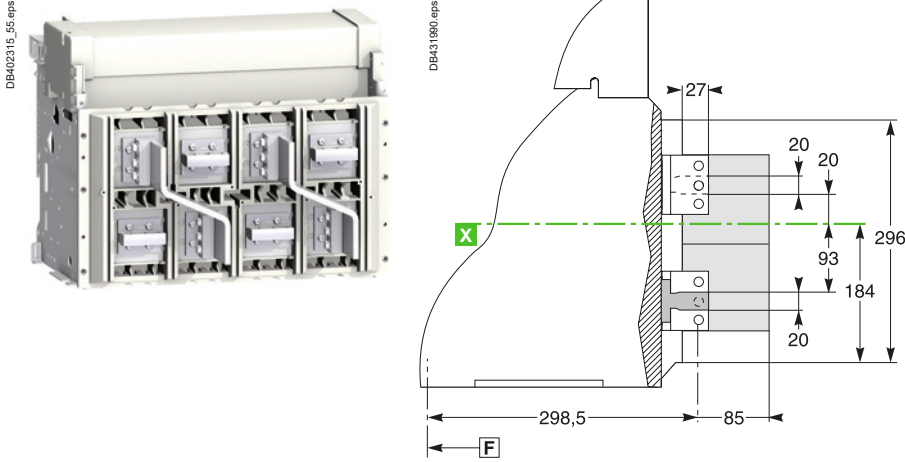

### Detail

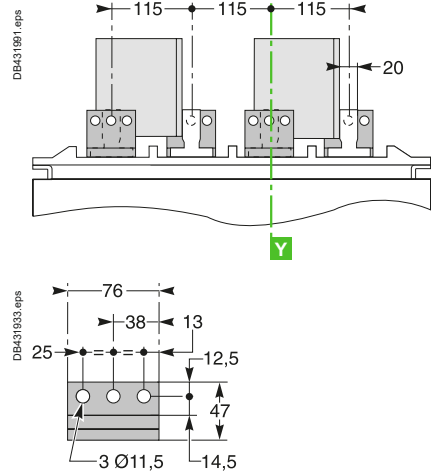

### Vertical Rear Connection (NW10–NW20 DC)

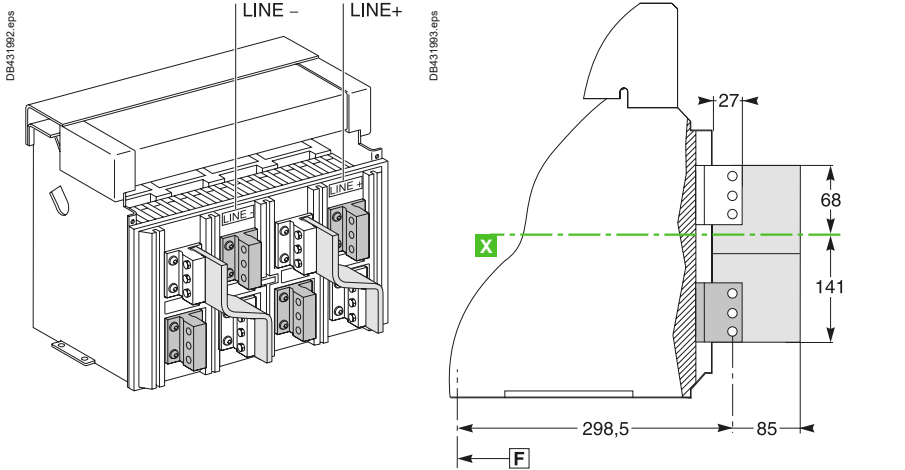

### Detail

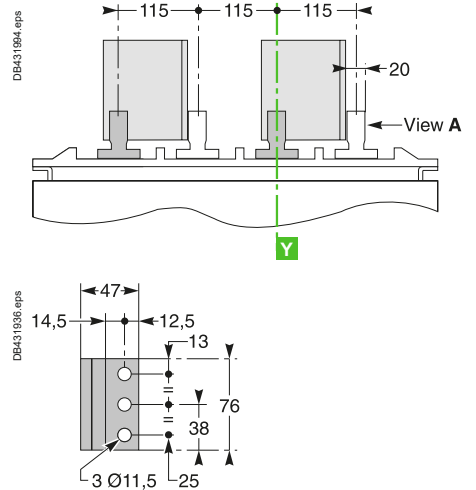

### Vertical Rear Connection (NW40 DC)

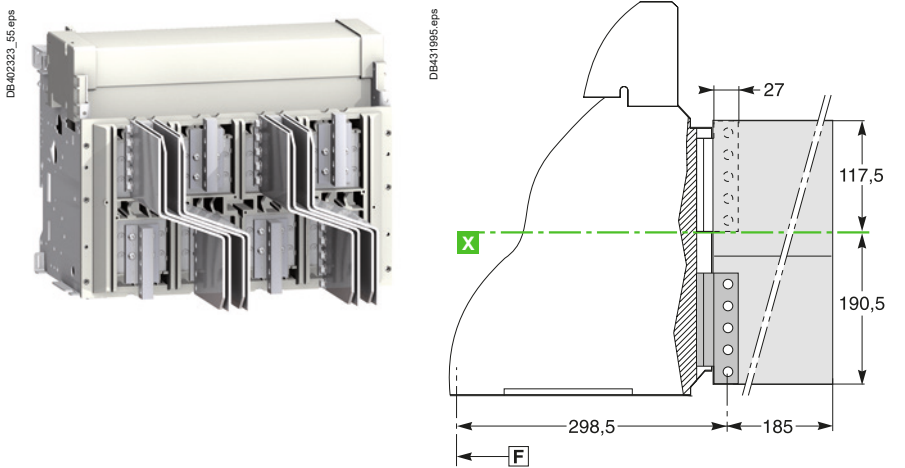

### Detail

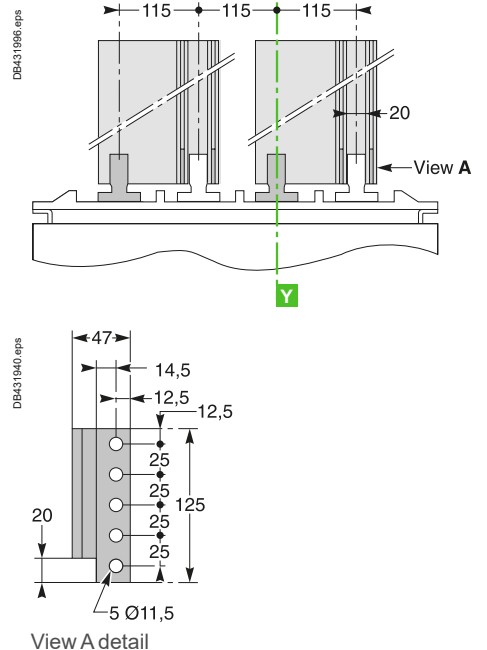

**Note:** Recommended connection screws: M10 class 8.8.  
Tightening torque: 50 Nm with contact washer.

### Rear Panel Cutout (Drawout Device)

NW10 to NW40 DC-DC PV

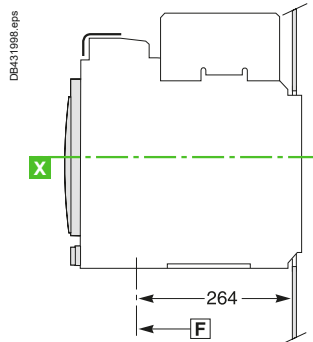
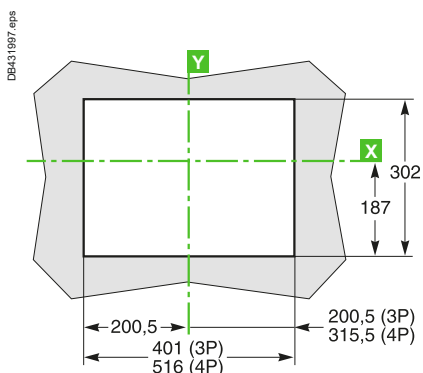

F: Datum



### Escutcheon

Fixed Device

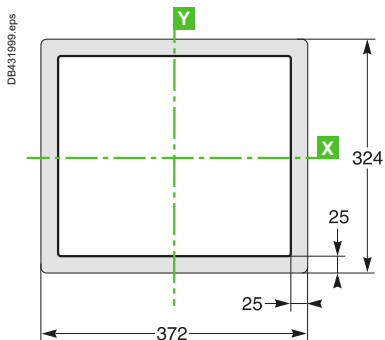

Drawout Device

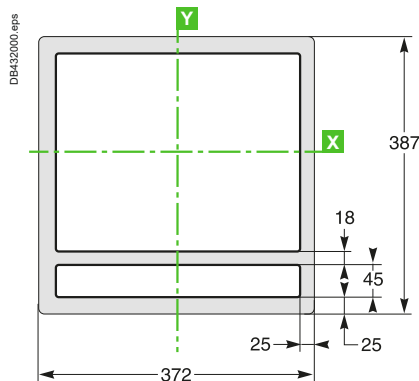

### Connection of Auxiliary Wiring to Terminal Block

DB431955.eps

- S : 0,6 mm<sup>2</sup>
- S : 2,5 mm<sup>2</sup>

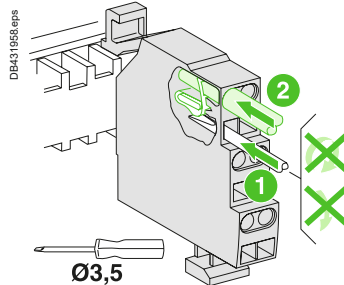
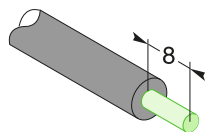

One conductor only per connection point

# MasterPact NW10 to 40 DC, EPDC, DC PV Accessories

## Delay Unit for MN Release

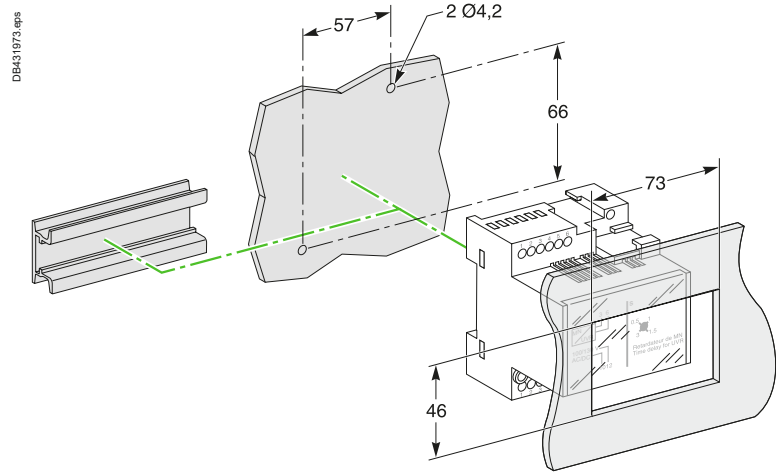
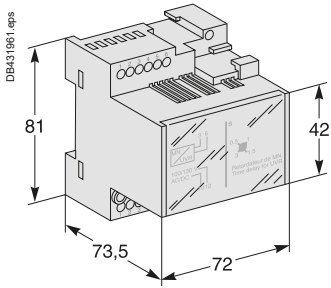

## “Chassis” Communication Module

### Modbus

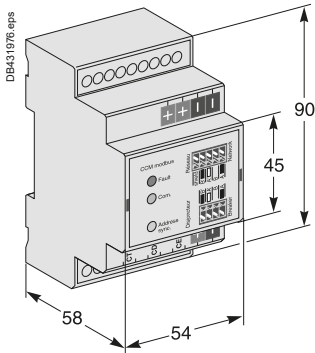



# Dimensions and Mounting External Modules for ComPacT and MasterPact

## I/O (Input/Output) Application Module

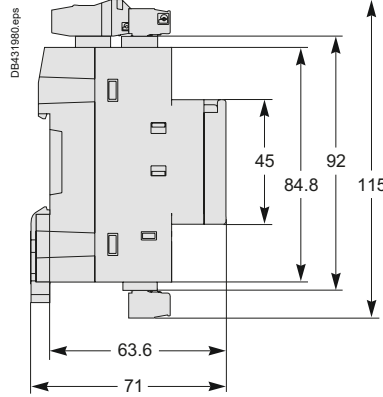
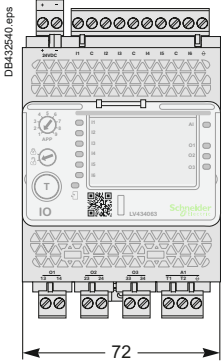

## IFM-Modbus-SL Interface

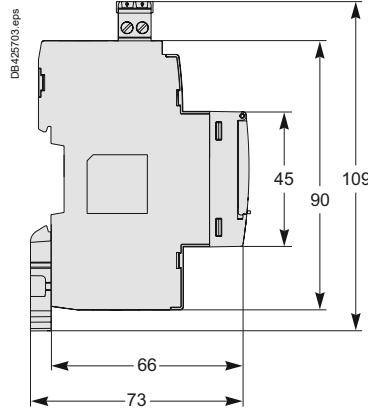
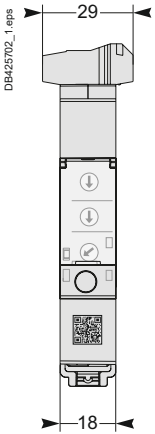

## IFE-Ethernet Interface

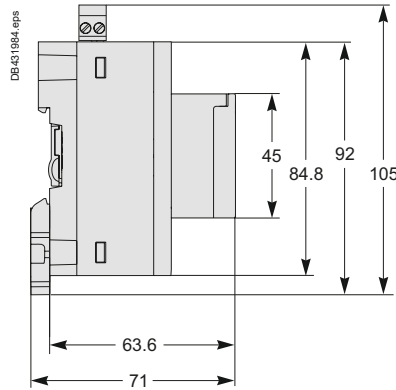
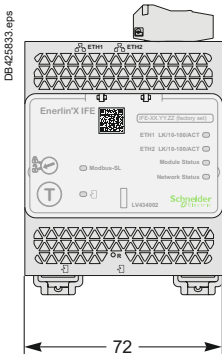

## Com'X 210

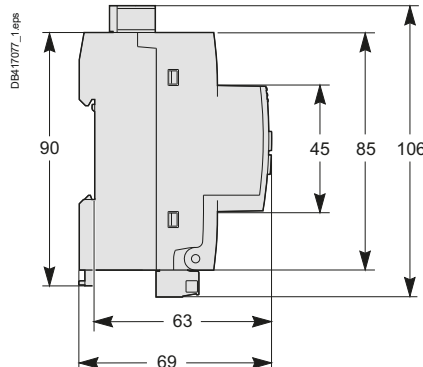
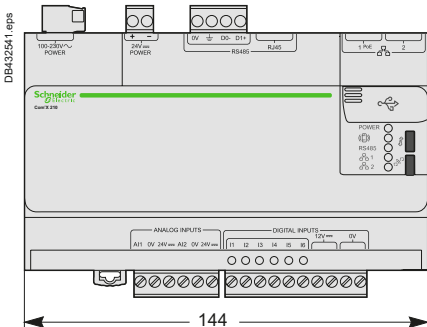

# Dimensions and Mounting

## FDM121 Switchboard Display

### Dimensions

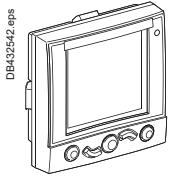

DB432542.eps

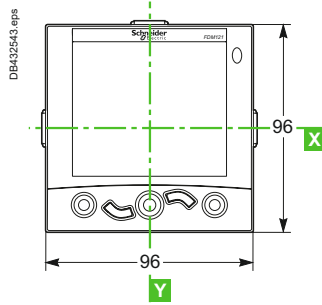

DB432543.eps

### Mounting

#### Through Panel

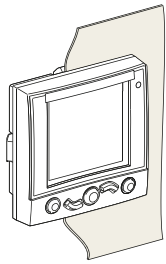

DB432544.eps

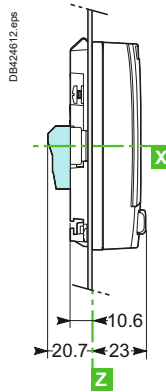

DB424612.eps

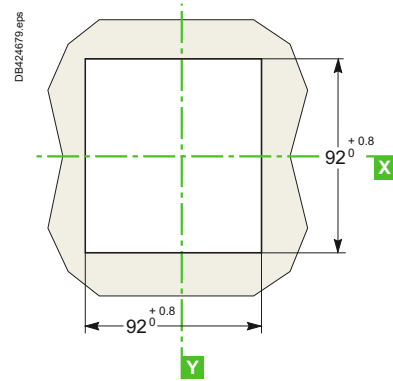

DB424679.eps

#### On Panel

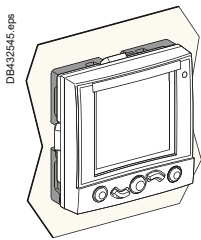

DB432545.eps

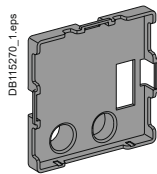

DB115270\_1.eps

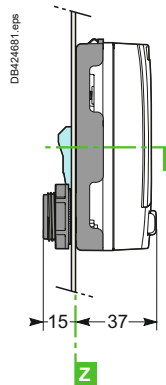

DB424681.eps

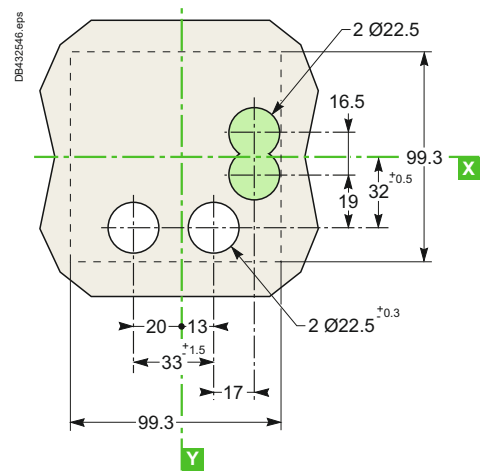

DB432546.eps

 Connector (optional)

# FDM128 Switchboard Display

## Dimensions

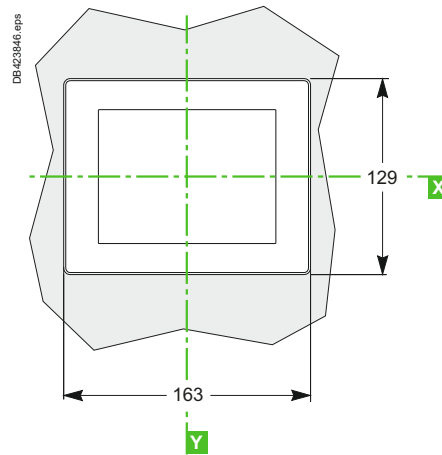
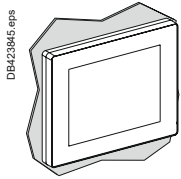

## Mounting

### On Panel

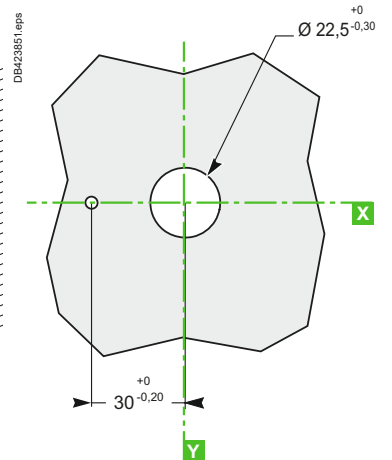
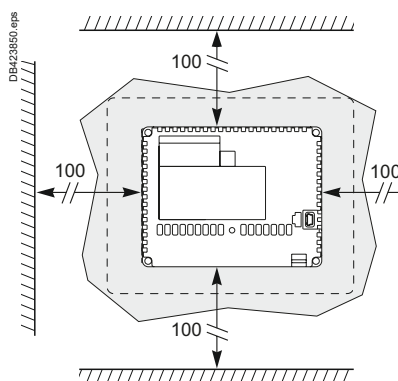
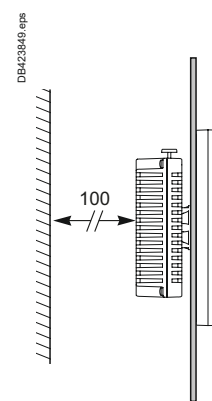
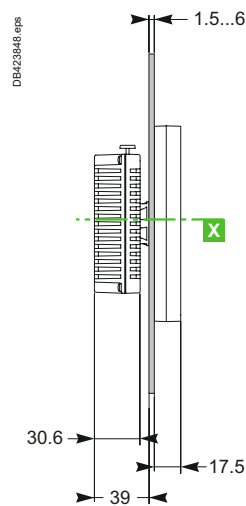
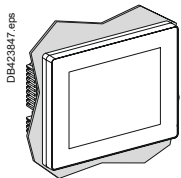







# Electrical Diagrams

<b>ComPacT NSX100 to 1200 DC</b>	
Fixed Circuit Breakers.....	D-2
<b>ComPacT NSX100 to 630 DC</b>	
Plug-in/Withdrawable Circuit Breakers.....	D-4
<b>ComPacT NSX100 to 630 DC - DC PV</b>	
Motor Mechanism .....	D-6
Communication.....	D-8
<b>ComPacT NSX630b to NSX1600 DC PV</b>	
Fixed Switch-Disconnectors .....	D-10
<b>MasterPact NW10 to NW40 DC - DC PV</b>	
Fixed and Drawout Devices.....	D-12
<b>MasterPact NW DC - DC PV</b>	
Communication.....	D-14
<b>Fixed, Electrically Operated MasterPact NW DC - DC PV</b>	
Connection to the Communication Interface Module.....	D-15
<b>Withdrawable MasterPact NW DC - DC PV</b>	
Connection to the I/O and Communication Interface Module .....	D-16



<b>Other Chapters</b>	
Presentation .....	2
Functions and Characteristics .....	A-1
Installation Recommendations.....	B-1
Dimensions and Connection .....	C-1
Additional Characteristics.....	E-1
Catalog Numbers and Order Form .....	F-1

# ComPacT NSX100 to 1200 DC

## Fixed Circuit Breakers

### Remote Operation

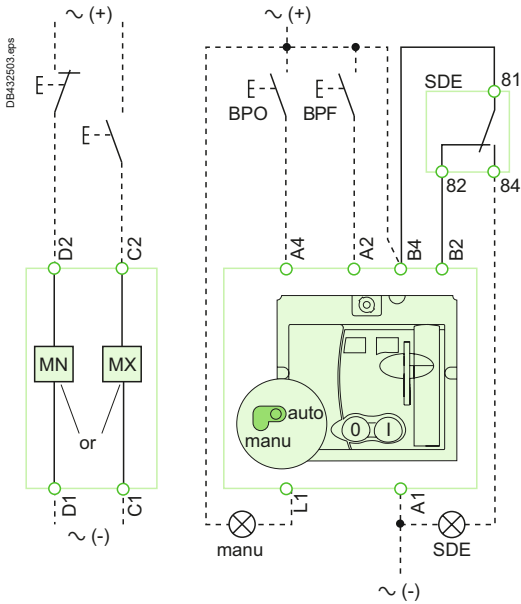

Motor mechanism (MT)

### Remote Operation

**MN:** undervoltage release

**or**

**MX:** shunt release

#### Motor mechanism (MT)

**A4:** opening order

**A2:** closing order

**B4, A1:** power supply to motor mechanism

**L1:** manual position (manu)

**B2:** SDE interlocking (mandatory for correct operation)

**BPO:** opening pushbutton

**BPF:** closing pushbutton

#### Communicating motor mechanism (MTc) <sup>[1]</sup>

**B4, A1:** motor mechanism power supply

**BSCM:** breaker status and control module

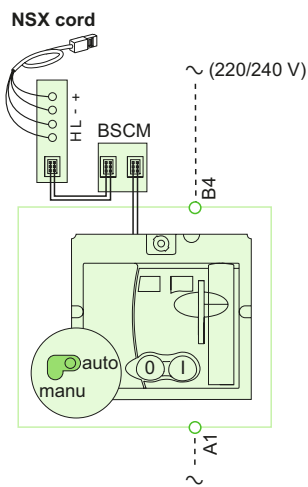

Communicating motor mechanism (MTc)

D

**Indication Contacts**

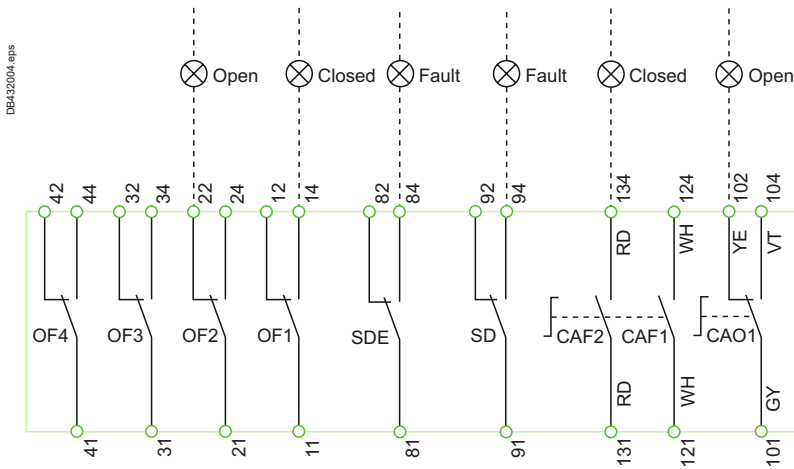

The diagram is shown with circuits de-energized, all devices open, connected and charged and relays in normal position. Terminals shown in ○ must be connected by the customer.

- OF2/OF1:** device ON/OFF indication contacts
- OF4/OF3:** device ON/OFF indication contacts (NSX400/630)
- SDE:** fault-trip indication contact (short-circuit, overload, ground fault, earth leakage)
- SD:** trip-indication contact
- CAF2/CAF1:** early-make contact (rotary handle only)
- CAO1:** early-break contact (rotary handle only)

**Color Code for Auxiliary Wiring**

- |                   |                   |
|-------------------|-------------------|
| <b>RD:</b> red    | <b>VT:</b> violet |
| <b>WH:</b> white  | <b>GY:</b> grey   |
| <b>YE:</b> yellow | <b>OR:</b> orange |
| <b>BK:</b> black  | <b>BL:</b> blue   |
| <b>GN:</b> green  |                   |





# ComPacT NSX100 to 630 DC

## Plug-in/Withdrawable Circuit Breakers

### Remote Operation

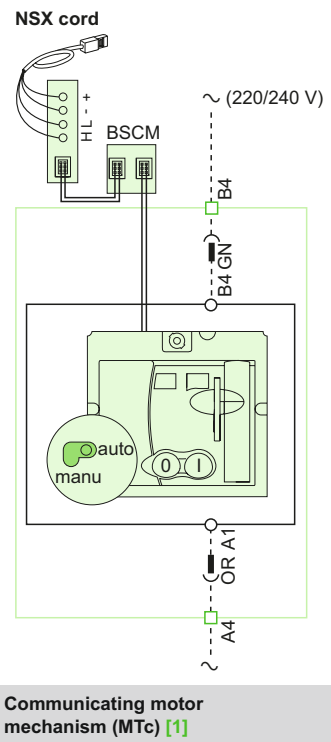
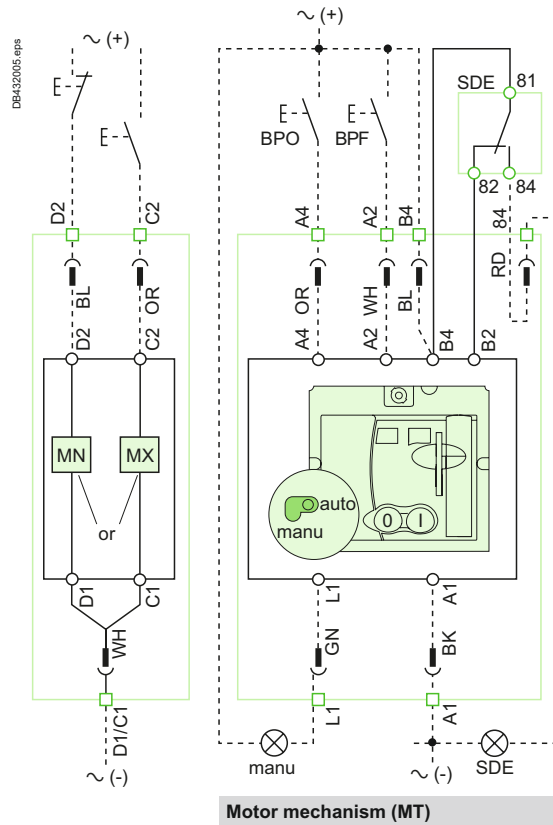

[1] NSX100-250 DC only.

# Electrical Diagrams

## ComPacT NSX100 to 630 DC Plug-in/Withdrawable Circuit Breakers

### Indication Contacts

### Carriage Switches

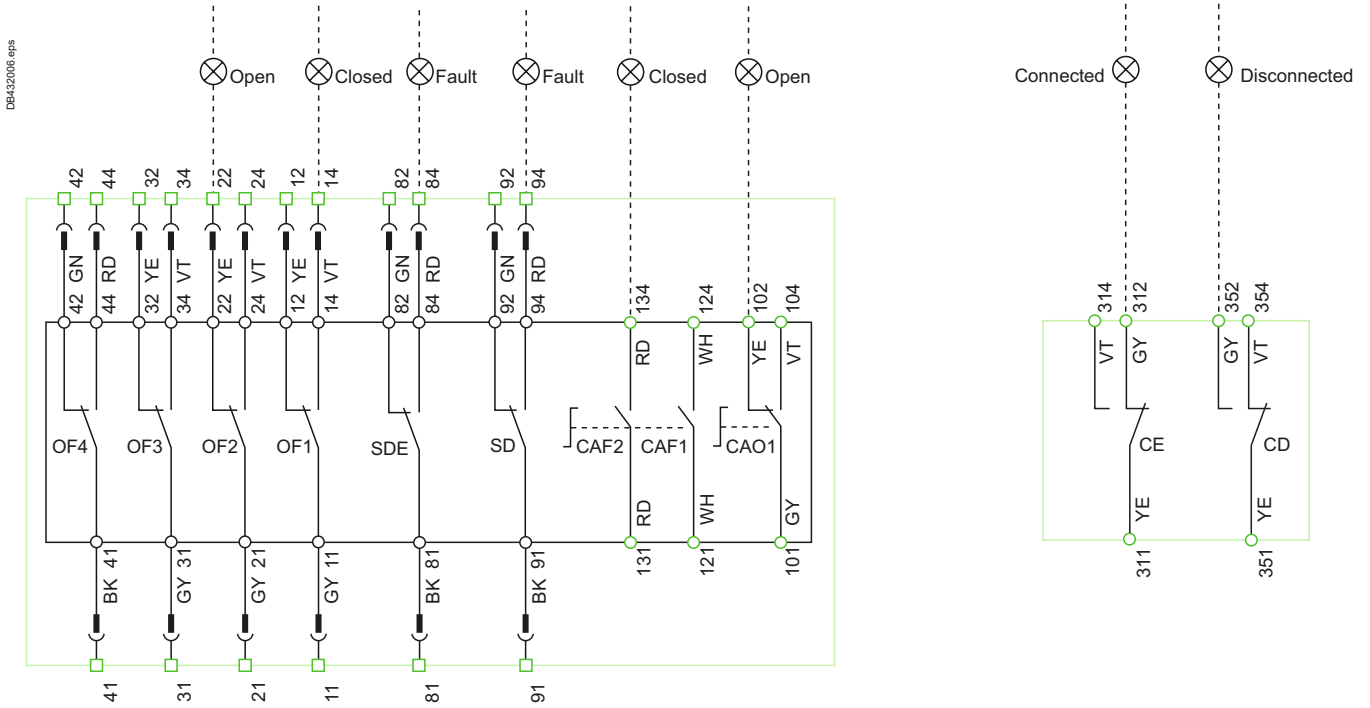

### Remote Operation

**MN:** undervoltage release

or

**MX:** shunt release

#### Motor mechanism (MT)

**A4:** opening order

**A2:** closing order

**B4, A1:** motor mechanism power supply

**L1:** manual position (manu)

**B2:** SDE interlocking (mandatory for automatic or remote recharging)

**BPO:** opening pushbutton

**BPF:** closing pushbutton

#### Communicating motor mechanism (MTc)

**B4, A1:** motor mechanism power supply

**BSCM:** breaker status and control module

### Indication Contacts

**OF2/OF1:** device ON/OFF indication contacts

**OF4/OF3:** device ON/OFF indication contacts (NSX400/630)

**SDE:** fault-trip indication contact

(short-circuit, overload, ground fault, earth leakage)

**SD:** trip-indication contact

**CAF2/CAF1:** early-make contact (rotary handle only)

**CAO1:** early-break contact (rotary handle only)



# ComPacT NSX100 to 630 DC - DC PV Motor Mechanism

## Motor Mechanism (MT) with Automatic Reset

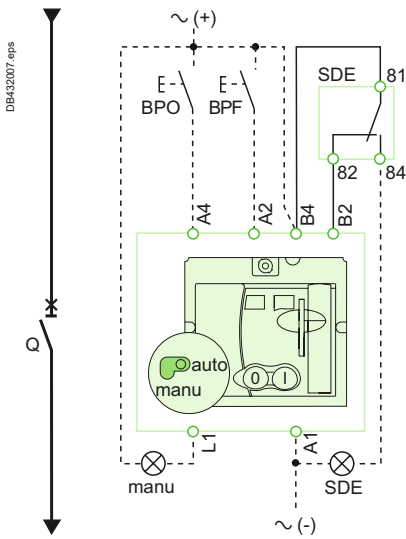

The diagram is shown with circuits de-energized, all devices open, connected and charged and relays in normal position.

After tripping initiated by the "Push to trip" button or by the undervoltage (MN) release or the shunt (MX) release, device reset can be automatic, remote or manual.

Following tripping due to an electrical fault (with an SDE contact), reset must be carried out manually.

## Motor Mechanism (MT) with Remote Reset

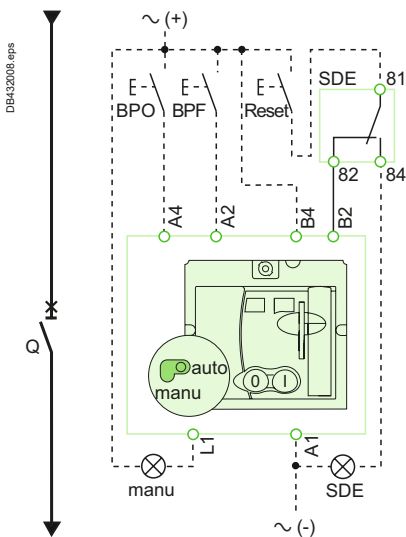

## Motor Mechanism (MT) with Manual Reset

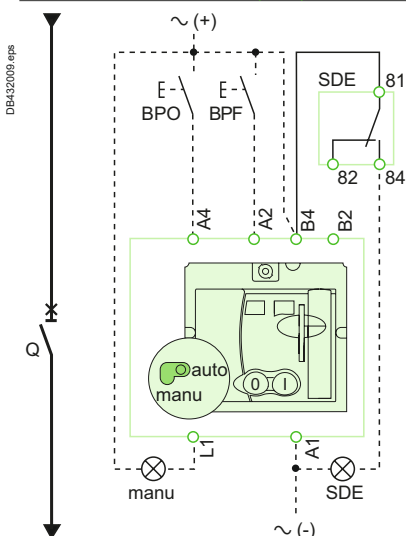

### Symbols

- Q:** circuit breaker
- A4:** opening order
- A2:** closing order
- B4, A1:** motor mechanism power supply
- L1:** manual position (manu)
- B2:** SDE interlocking (mandatory for correct operation)
- BPO:** opening pushbutton
- BPF:** closing pushbutton
- SDE:** fault-trip indication contact (short-circuit, overload, ground fault, earth leakage)

# Electrical Diagrams

## ComPacT NSX100 to 630 DC - DC PV Motor Mechanism

### Communicating Motor Mechanism (MTC) [1]

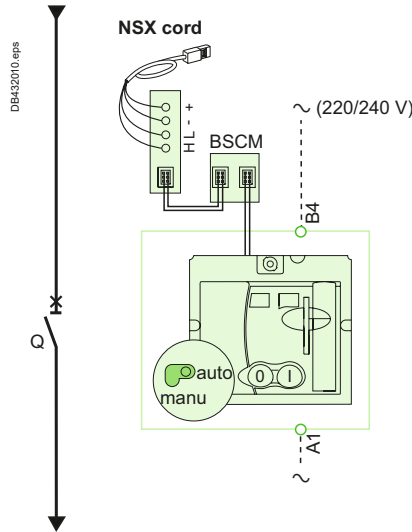

Schematic representation of the communicating motor mechanism (MT).

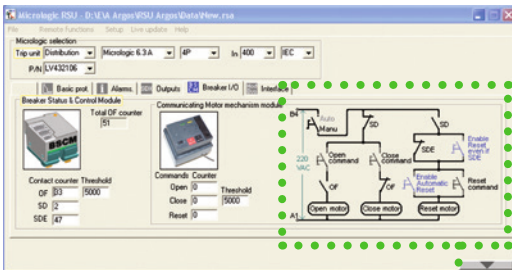

RSU utility setup screen for the communicating motor mechanism

### RSU screen for the communicating motor mechanism (MTC)

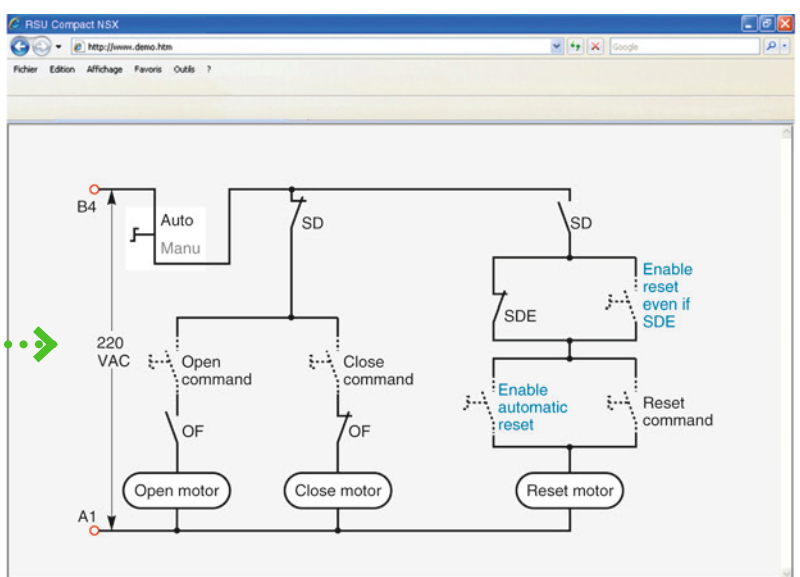

#### Single-line diagram of communicating motor mechanism

Opening, closing and reset orders are transmitted via the communication network. The "Enable automatic reset" and "Enable reset even if SDE" parameters must be set using the RSU software via the screen by clicking the blue text.

"Auto/manu" is a switch on the front of the motor mechanism.

#### Symbols

- Q:** circuit breaker
- B4, A1:** motor mechanism power supply
- BSCM:** breaker status and control module

Terminals shown in **O** must be connected by the customer.

[1] NSX100-250 only.

# ComPacT NSX100 to 630 DC - DC PV - DC EP Communication

## Connection of Circuit Breakers to the Modbus Communication Network

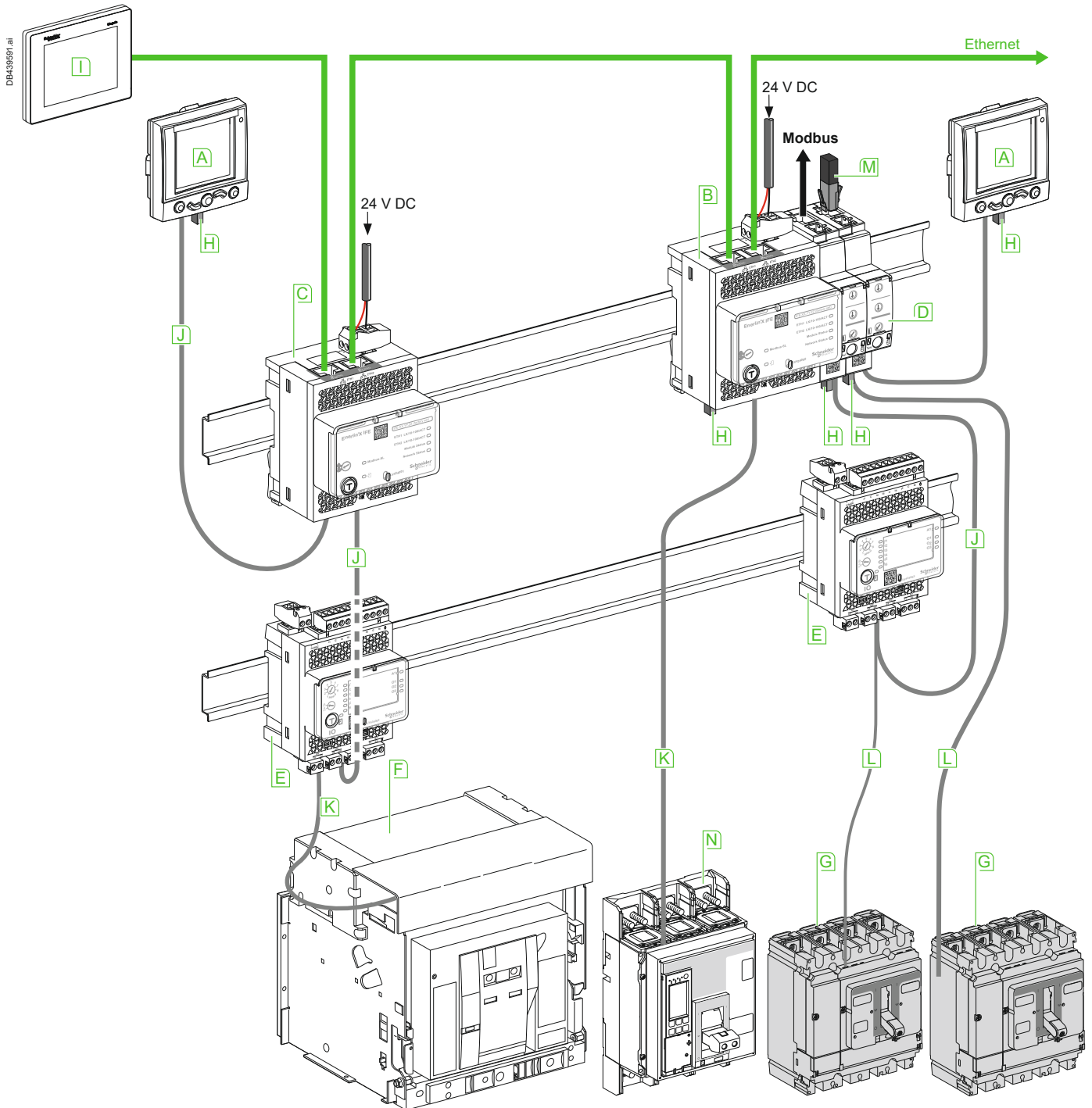

- A** FDM121 (TRV00121)
- B** IFE master (LV434002)
- C** IFE (LV434001)
- D** IFM (LV434000)
- E** I/O application module (LV434063)
- F** MasterPact NW
- G** ComPacT NSX
- H** ULP termination (TRV00880)
- I** FDM128 (LV434128)
- M** Modbus Termination<sup>[1]</sup> (VW3A8306RC)
- N** ComPacT NS630b-3200

	<b>J</b> ULP cable
	<b>K</b> Breaker ULP cord
	<b>L</b> NSX cord
	Ethernet
	Modbus

[1] Modbus termination is mandatory, see ULP system user guide TRV99101.

# ComPacT NSX100 to 630 DC - DC PV - DC EP Communication

DE439133.ai

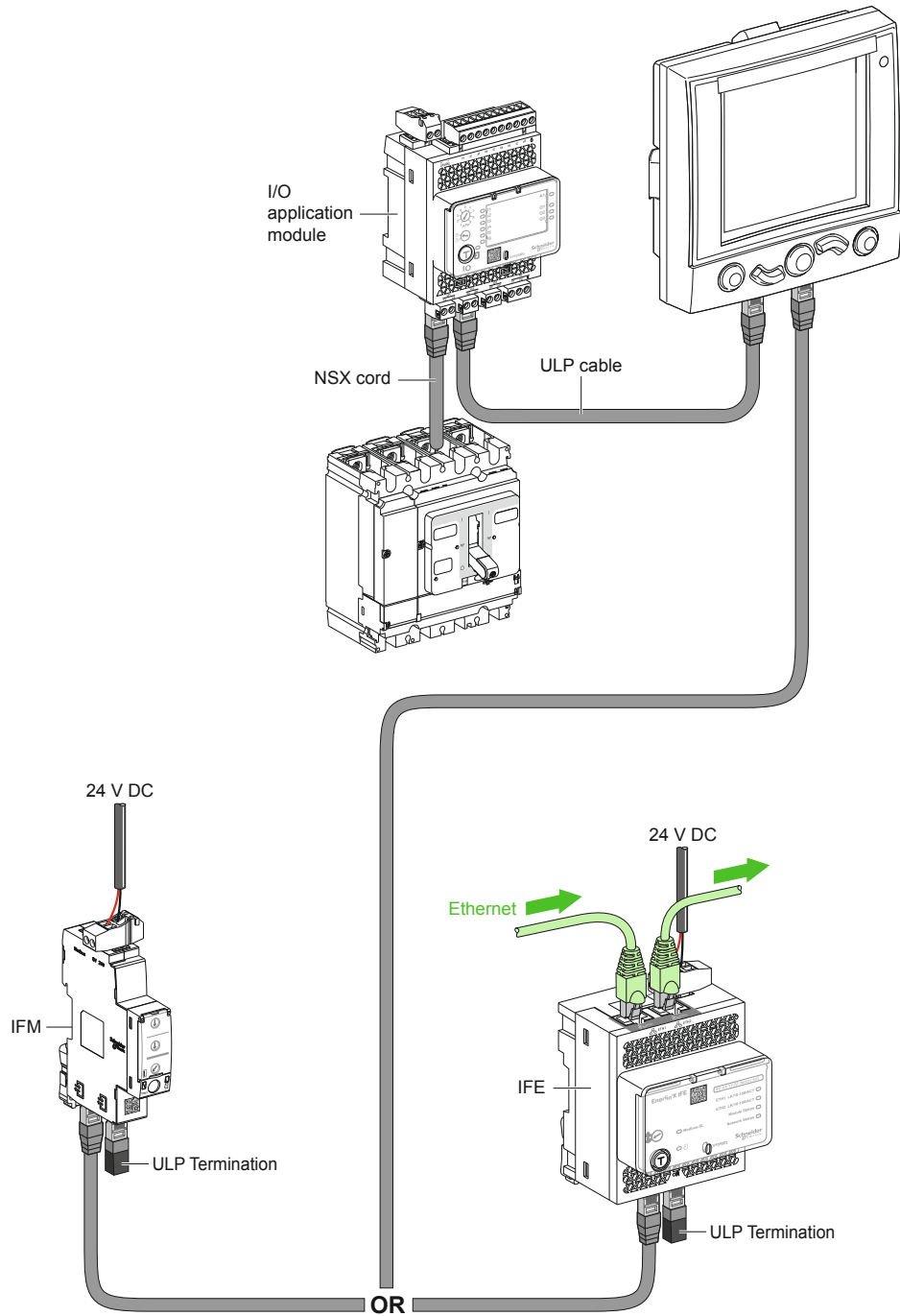

# ComPacT NSX630b to NSX1600 DC PV Fixed Switch-Disconnectors

The diagram is shown with circuits de-energized, all devices open, connected and charged and relays in the normal position.

## Remote Operation

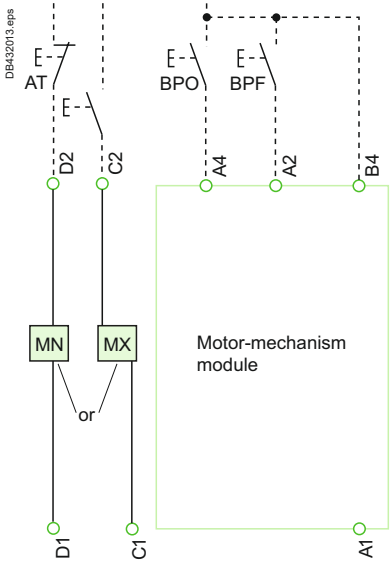

- MN** : undervoltage release
- or**
- MX** : shunt release

**Motor-mechanism module** <sup>[1]</sup>

- A4** : electrical opening order
- A2** : electrical closing order
- B4, A1** : power supply for control devices and gear motor

[1] Spring-charging motor 440/480 V AC (380 V motor + additional resistor).

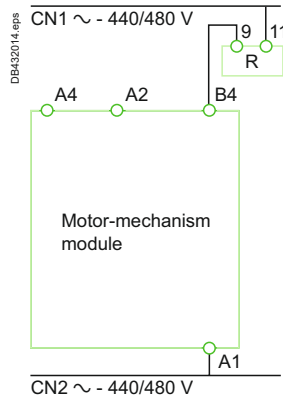



# ComPacT NSX630b to NSX1600 DC PV Fixed Switch-Disconnectors

## Indication Contacts

**OF3/OF2/OF1** : indication contacts

## Terminal-Block Marking (Electrical Operation)

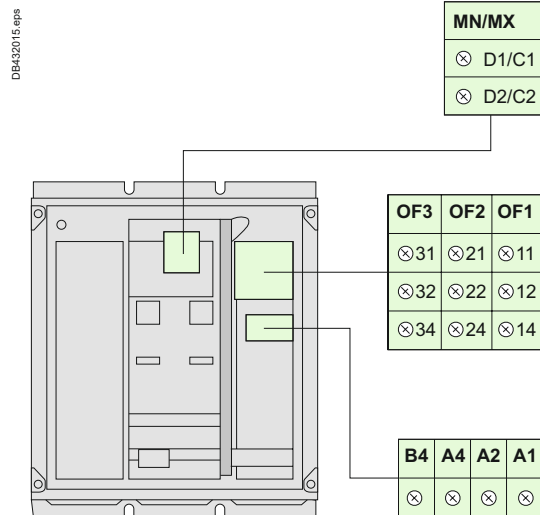

# MasterPact NW10 to NW40 DC - DC PV

## Fixed and Drawout Devices

Diagrams are shown with circuits de-energized, all devices open, connected and charged and relays in the normal position.

### Version C - DC

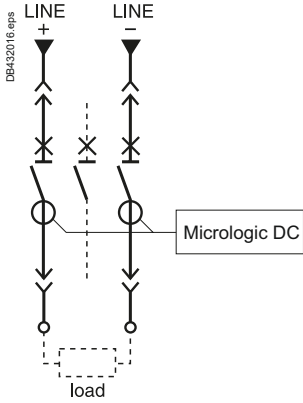

### Version D - DC

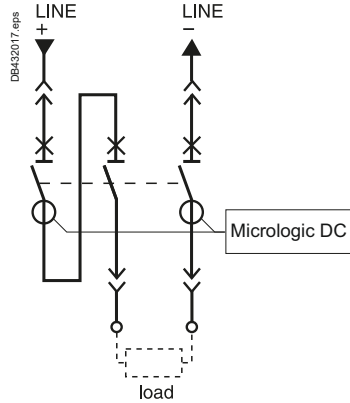

### Remote Operation

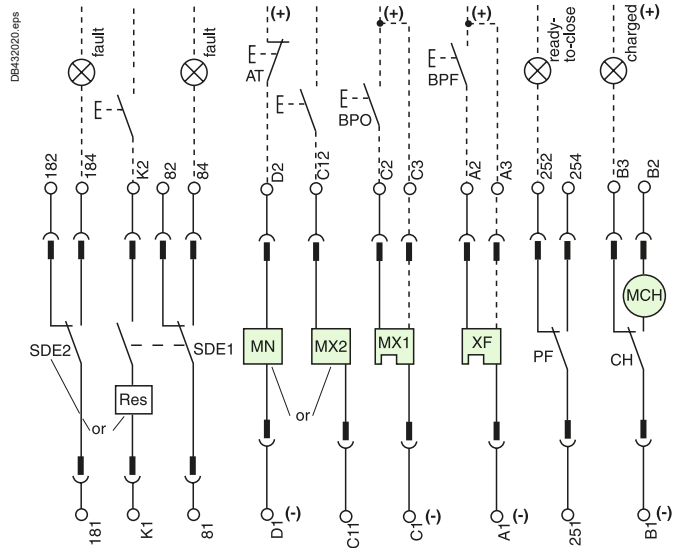

### Version E - DC

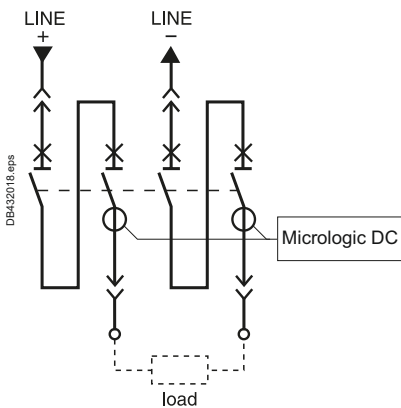

### Version D - DC PV

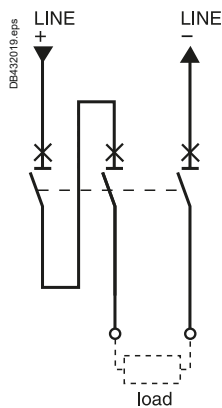

D

### Control Unit

#### Terminal block marking

Com: E1-E6 communication

- ○
- E5 E6
- ○
- E3 E4
- ○
- E1 E2

### Remote Operation

SDE2 / Res	SDE1	MN / MX2	MX1	XF	PF	MCH
○ ○	○ ○	○ ○	○ ○	○ ○	○ ○	○ ○
184 / K2	84	D2 / C12	C2	A2	254	B2
○ ○	○ ○		○ ○	○ ○	○ ○	○ ○
182	82		C3	A3	252	B3
○ ○	○ ○	○ ○	○ ○	○ ○	○ ○	○ ○
181 / K1	81	D1 / C11	C1	A1	251	B1

**SDE2:** fault-trip indication contact

or

**Res:** remote reset

**SDE1:** fault-trip indication contact (supplied as standard)

**MN:** undervoltage release

or

**MX2:** shunt release

**MX1:** shunt release (standard or communicating)

**XF:** closing release (standard or communicating)

**PF:** ready-to-close contact

**MCH:** electric motor

**Note:** When communicating MX or XF releases are used, the third wire (C3,A3) must be connected even if the communication module is not installed.

# MasterPact NW10 to NW40 DC - DC PV Fixed and Drawout Devices

## Indication Contacts

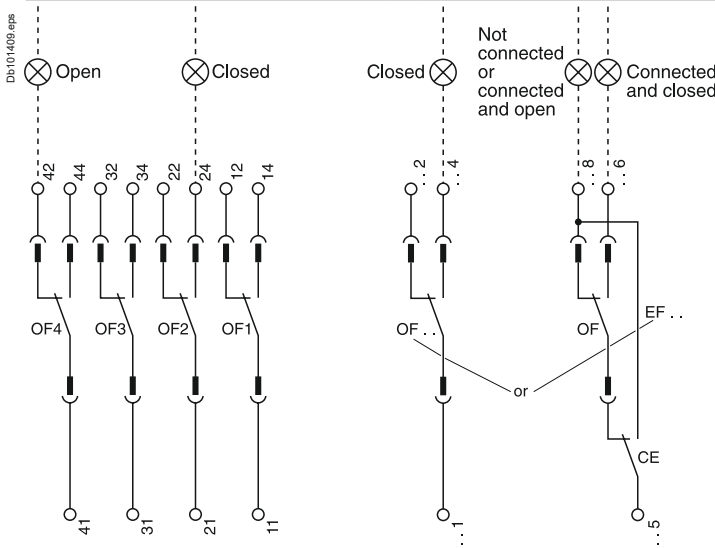

## Chassis Contacts

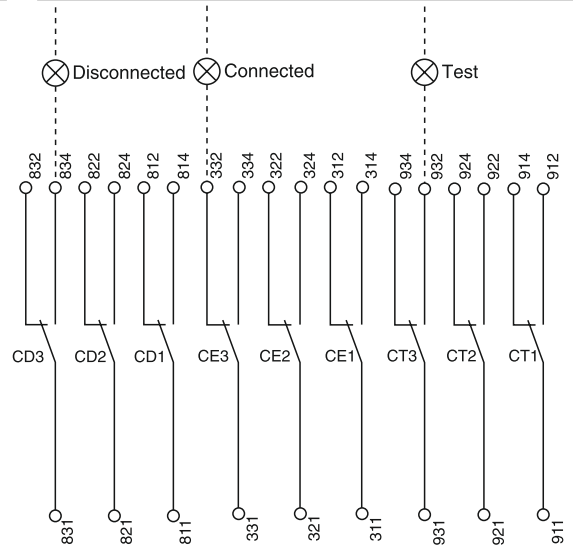

## Indication Contacts

OF4	OF3	OF2	OF1	OF24	OF23	OF22	OF21	OF14	OF13	OF12	OF11		
44	34	24	14	244	234	224	214	144	134	124	114		
42	32	22	12	242	232	222	212	142	132	122	112		
41	31	21	11	241	231	221	211	141	131	121	111		
or				or				or					
EF24	EF23	EF22	EF21	EF14	EF13	EF12	EF11	CE6	CE5	CE4	CE9	CE8	CE7
248	238	228	218	148	138	128	118	364	354	344	394	384	374
246	236	226	216	146	136	126	116	362	352	342	392	382	372
245	235	225	215	145	135	125	115	361	351	341	391	381	371

## Chassis Contacts

CD3	CD2	CD1	CE3	CE2	CE1	CT3	CT2	CT1
834	824	814	334	324	314	934	924	914
832	822	812	332	322	312	932	922	912
831	821	811	331	321	311	931	921	911
or			or			or		
CE6	CE5	CE4	CE9	CE8	CE7			
364	354	344	394	384	374			
362	352	342	392	382	372			
361	351	341	391	381	371			

## Indication Contacts

<b>OF4</b>	ON/OFF indication contacts	<b>OF24</b>	ON/OFF indication contacts
<b>OF3</b>		<b>or</b>	
<b>OF2</b>		<b>EF24</b>	Combined "connected-closed" indication contacts
<b>OF1</b>			
		<b>OF22</b> or <b>EF22</b>	
		<b>OF21</b> or <b>EF21</b>	
		<b>OF14</b> or <b>EF14</b>	
		<b>OF13</b> or <b>EF13</b>	
		<b>OF12</b> or <b>EF12</b>	
		<b>OF11</b> or <b>EF11</b>	

## Chassis Contacts

<b>CD3</b>	Disconnected position contacts	<b>CE3</b>	Connected position contacts	<b>CT3</b>	Test position contacts
<b>CD2</b>		<b>CE2</b>		<b>CT2</b>	
<b>CD1</b>		<b>CE1</b>		<b>CT1</b>	
<b>or</b>			<b>or</b>		
<b>CE6</b>	Connected position contacts	<b>CE9</b>	Connected position contacts	<b>CE8</b>	Connected position contacts
<b>CE5</b>		<b>CE7</b>		<b>CE7</b>	
<b>CE4</b>					
<b>or</b>			<b>or</b>		
		<b>CD6</b>	Disconnected position contacts	<b>CD5</b>	Disconnected position contacts
		<b>CD4</b>		<b>CD4</b>	

Legend:

- Drawout device only.
- SDE1, OF1, OF2, OF3, OF4 supplied as standard.
- Interconnected connections (only one wire per connection point).

# MasterPact NW DC - DC PV Communication

## Communication Architecture

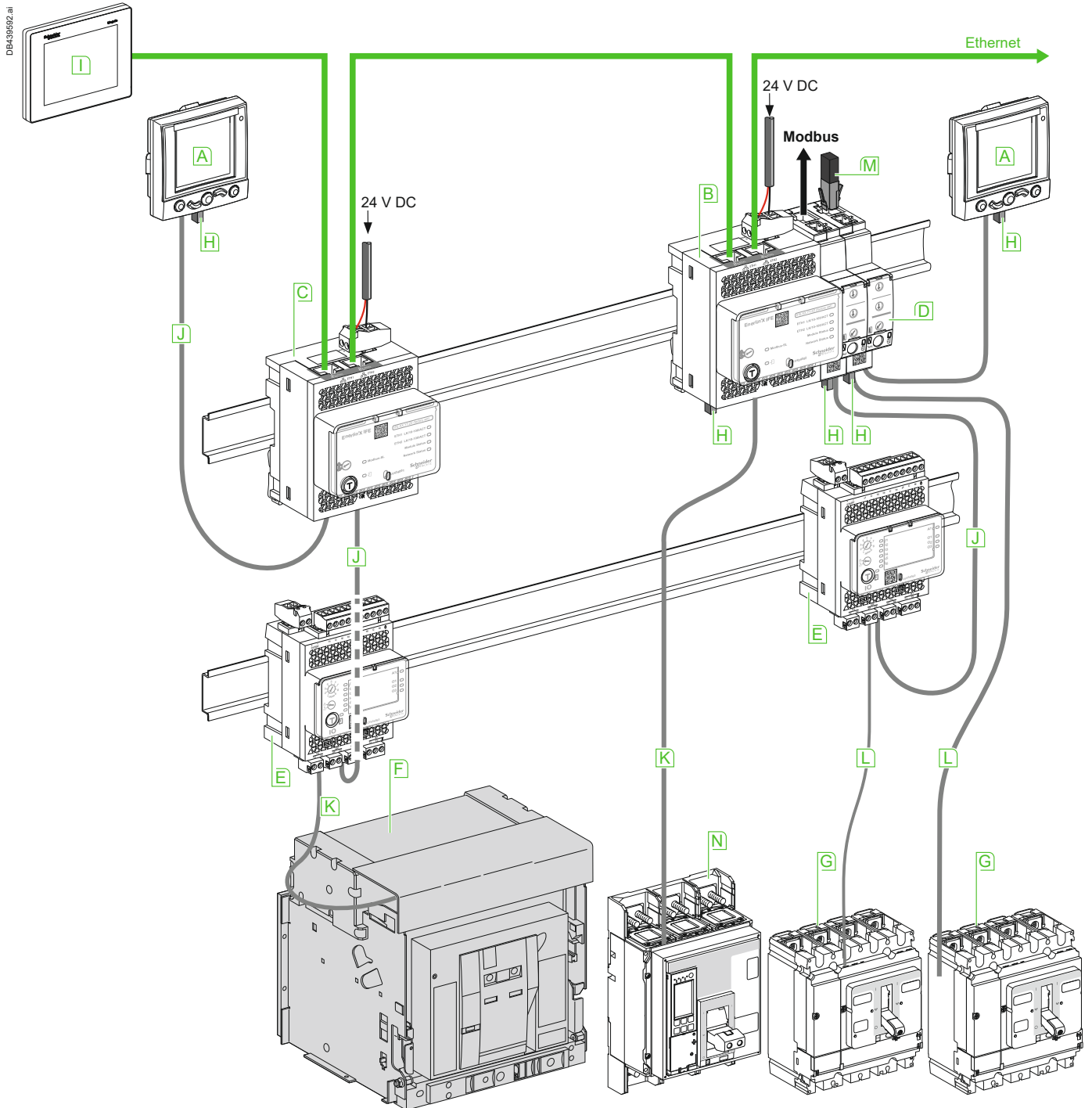





- A** FDM121 (TRV00121)
- B** IFE master (LV434002)
- C** IFE (LV434001)
- D** IFM (LV434000)
- E** I/O application module (LV434063)
- F** MasterPact NW
- G** ComPacT NSX
- H** ULP termination (TRV00880)
- I** FDM128 (LV434128)
- M** Modbus Termination<sup>[1]</sup> (VW3A8306RC)
- N** ComPacT NS630b-3200

	<b>J</b> ULP cable
	<b>K</b> Breaker ULP cord
	<b>L</b> NSX cord
	Ethernet
	Modbus

[1] Modbus termination is mandatory, see ULP system user guide TRV99101.

# Fixed, Electrically Operated MasterPact NW DC - DC PV Connection to the Communication Interface Module

DB432546.eps

Color			
Red		E1	24 V
Black		E2	0 V
White		E5	H
Blue		E6	L

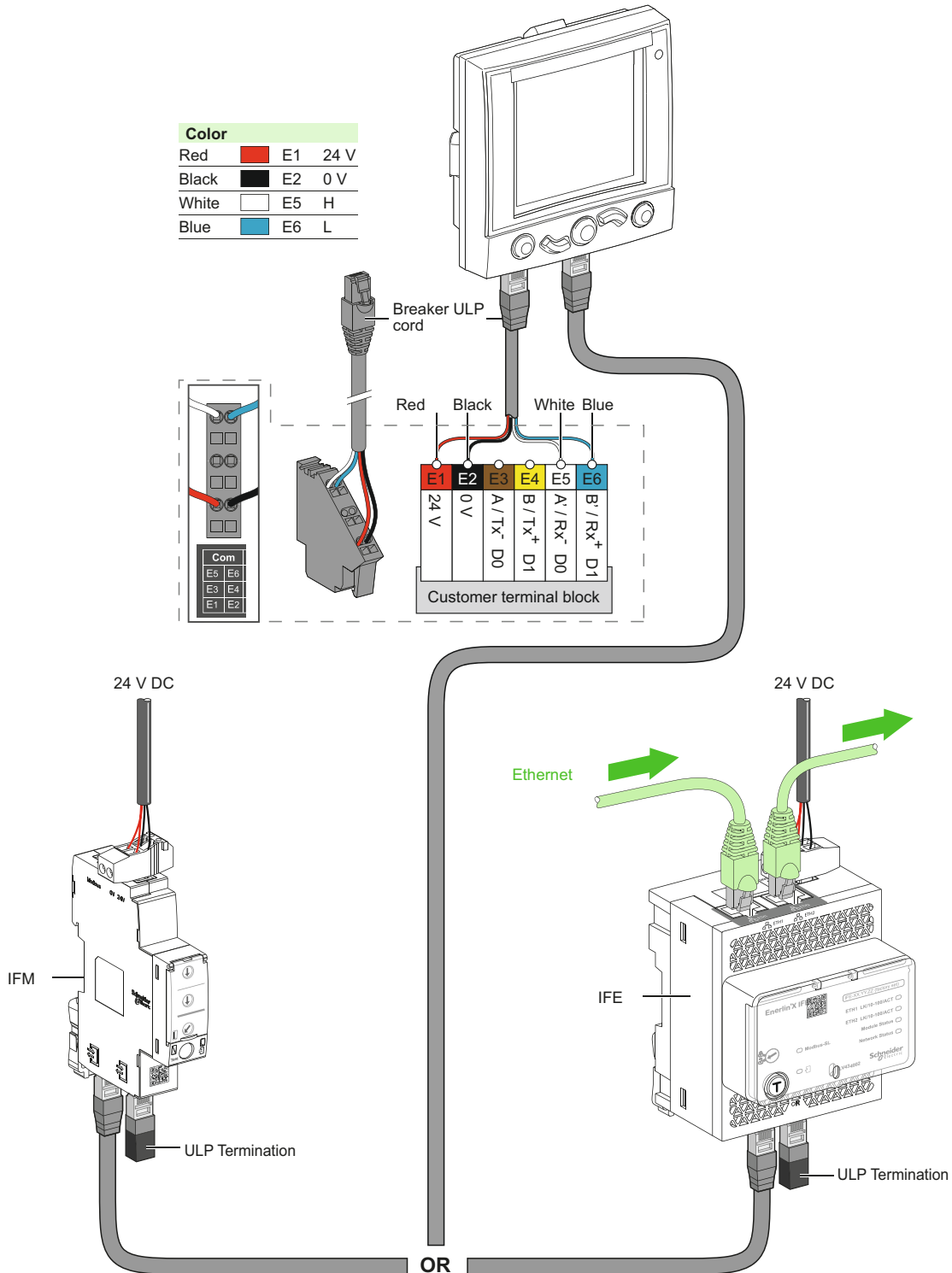

# Withdrawable MasterPact NW DC - DC PV

## Connection to the I/O and Communication Interface Module

DB432576-04PS

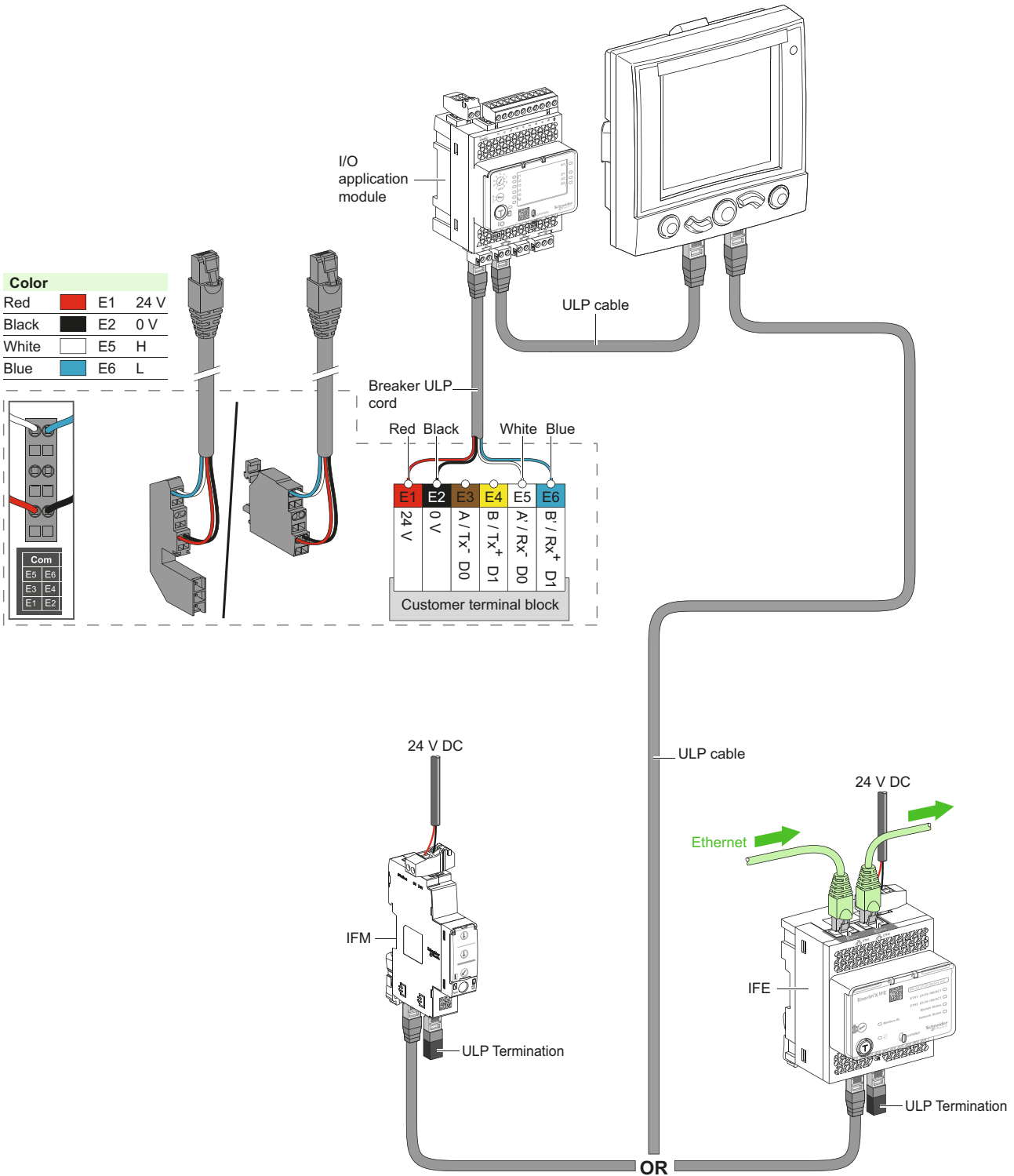

D

# Additional Characteristics

**ComPact NSX100 to 250 DC**  
TM-DC Magnetic Trip Units, Tripping Curves.....E-2  
TMG Magnetic Trip Units, Tripping Curves .....E-5

**ComPact NSX400 to 630 DC**  
TM-DC Trip Units, Tripping Curves.....E-8

**ComPact NSX630 to 1200 DC**  
TM-DC Trip Units, Tripping Curves.....E-10

**ComPacT NSX80 to 500 DC PV**  
TM-DC PV Magnetic Trip Units, Tripping Curves .....E-11

**Current and Energy Limiting Curves**  
ComPact NSX DC .....E-14  
ComPacT NSX DC EP.....E-16

**MasterPact NW10 to NW40 DC**  
Tripping Curves U = 500 V DC, L/R = 5 Ms .....E-18  
Tripping Curves U = 750/900 V DC, L/R = 5 Ms .....E-19  
Tripping Curves U = 500 V DC, L/R = 15 Ms .....E-20  
Tripping Curves U = 750/900 V DC, L/R = 15 Ms .....E-21  
Tripping Curves U = 500/750 V DC, L/R = 30 Ms .....E-22  
Tripping Curves U = 900 V DC, L/R = 30 Ms .....E-23



**Other Chapters**  
Presentation .....2  
Functions and Characteristics .....A-1  
Installation Recommendations.....B-1  
Dimensions and Connection .....C-1  
Electrical Diagrams.....D-1  
Catalog Numbers and Order Form .....F-1



# ComPact NSX100 to 250 DC

## TM-DC Magnetic Trip Units, Tripping Curves

### TM-DC 16

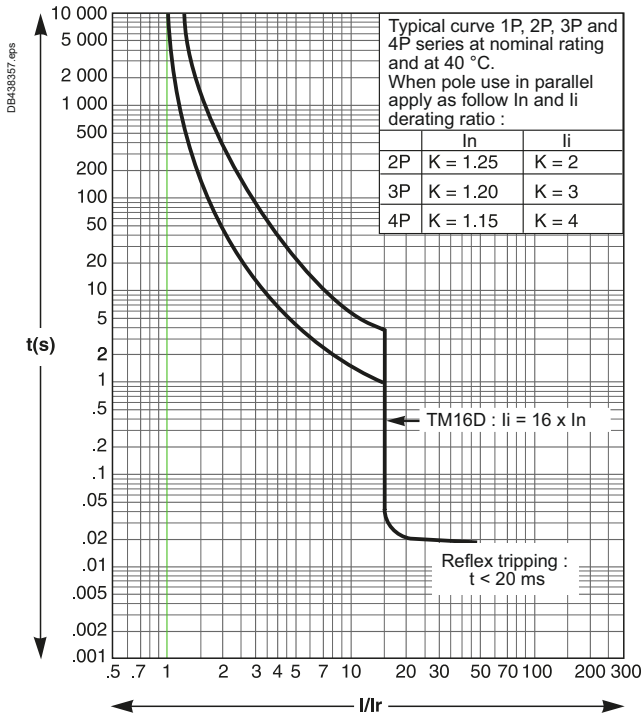

### TM-DC 25

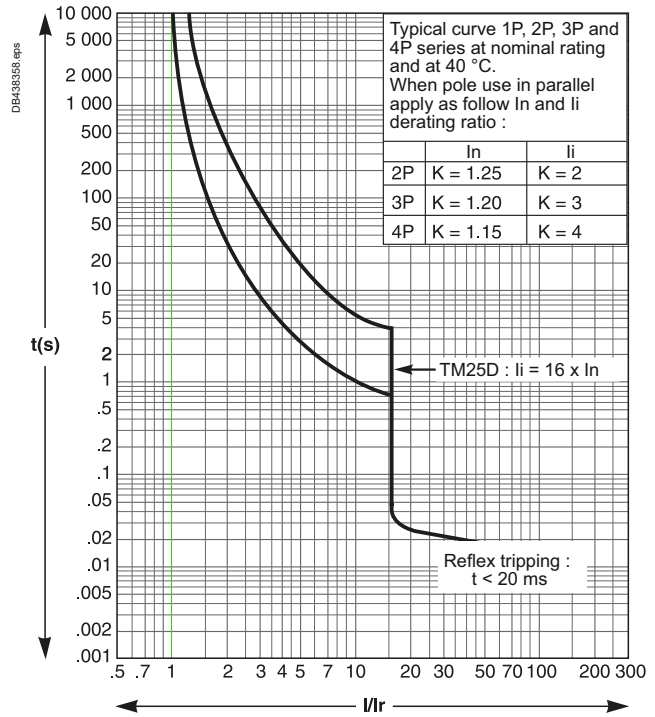

Reflex tripping.

### TM-DC 30/TM-DC 32

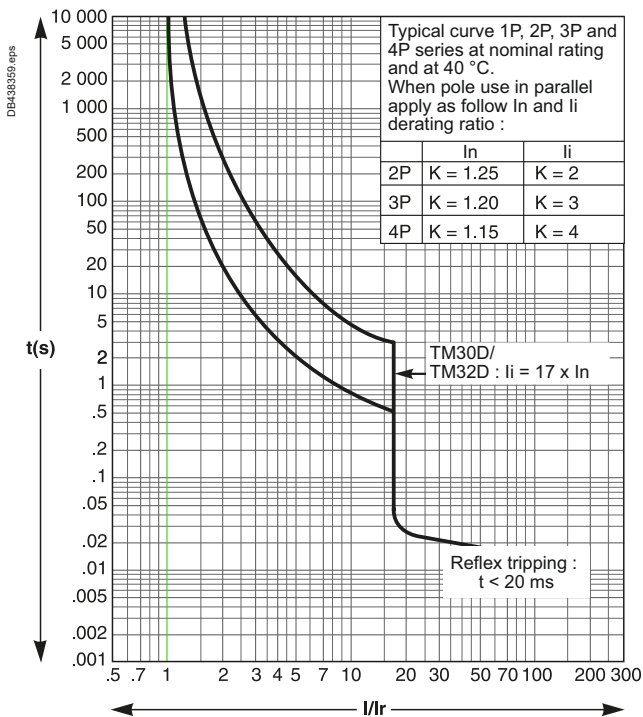

### TM-DC 40

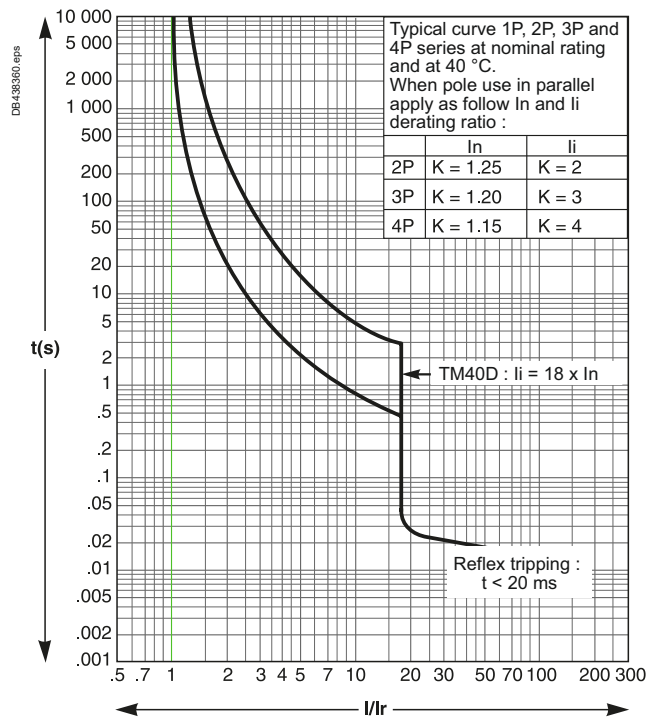

Reflex tripping.

E

# ComCompact NSX100 to 250 DC TM-DC Magnetic Trip Units, Tripping Curves

## TM-DC 50

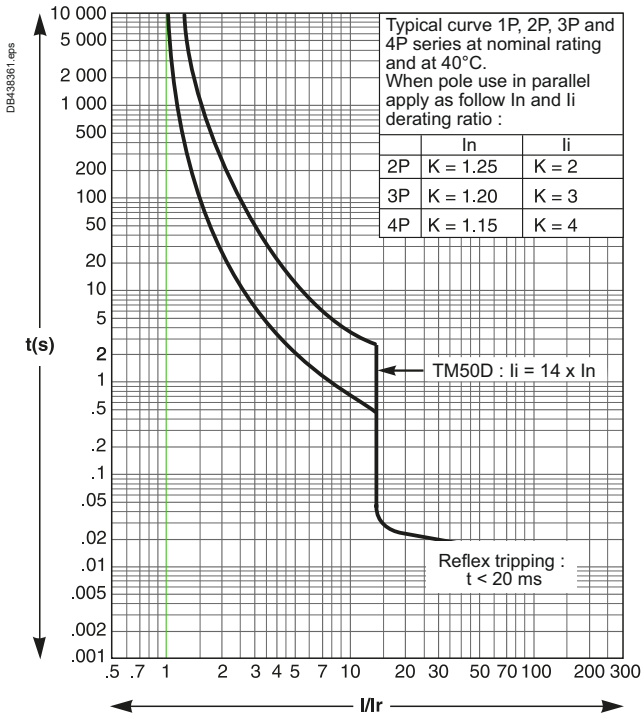

## TM-DC 63

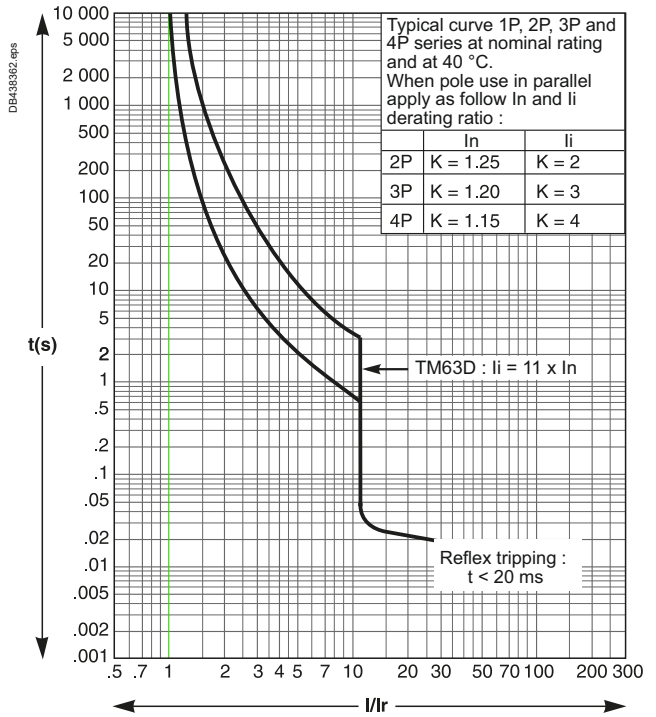

## TM-DC 80

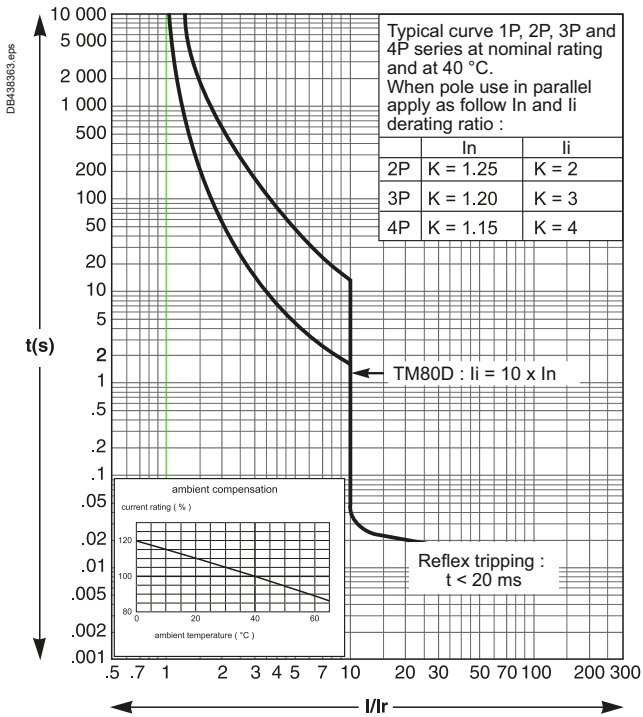

## TM-DC 100

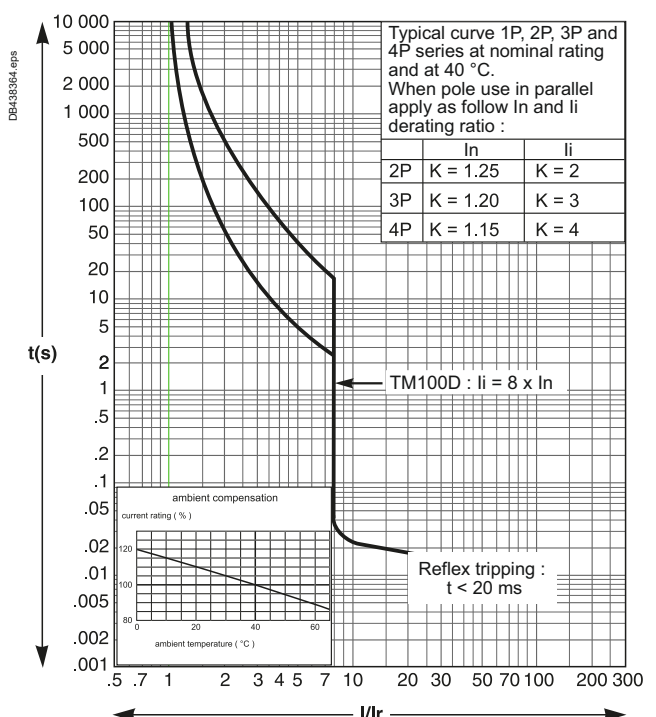

# ComPact NSX100 to 250 DC

## TM-DC Magnetic Trip Units, Tripping Curves

### TM-DC 125

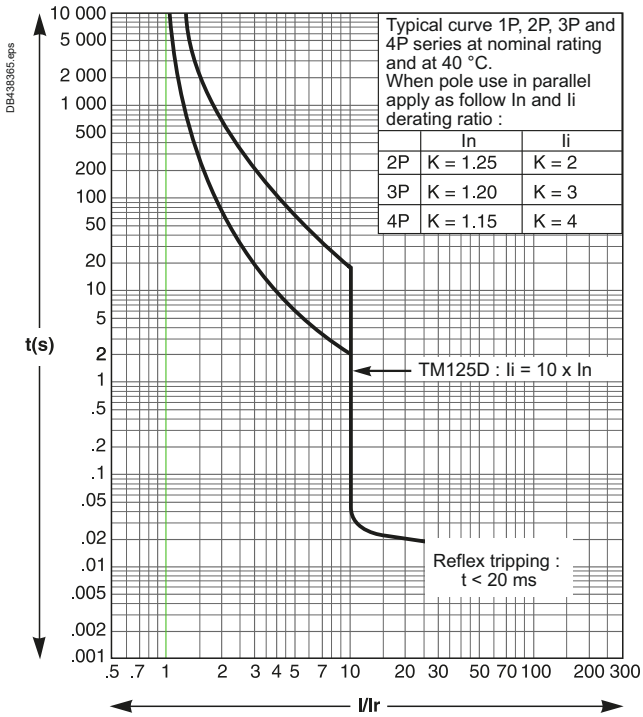

### TM-DC 160

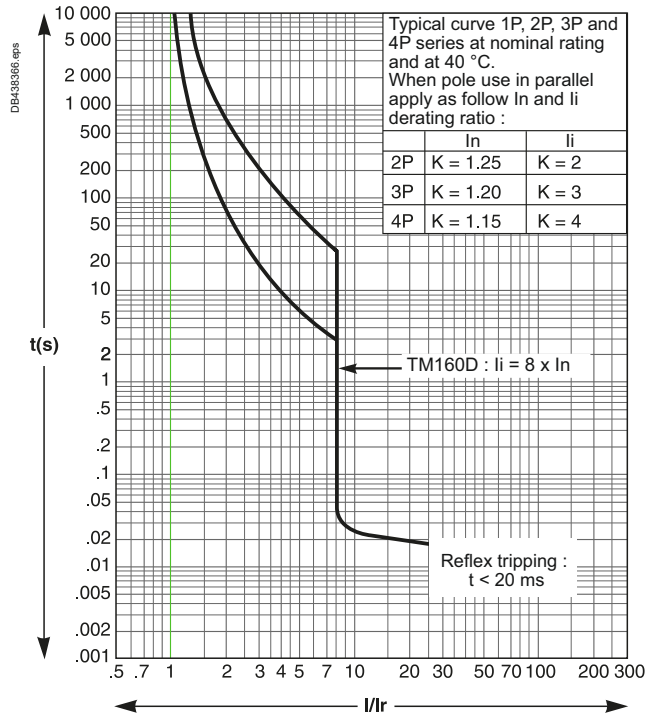

### TM-DC 200

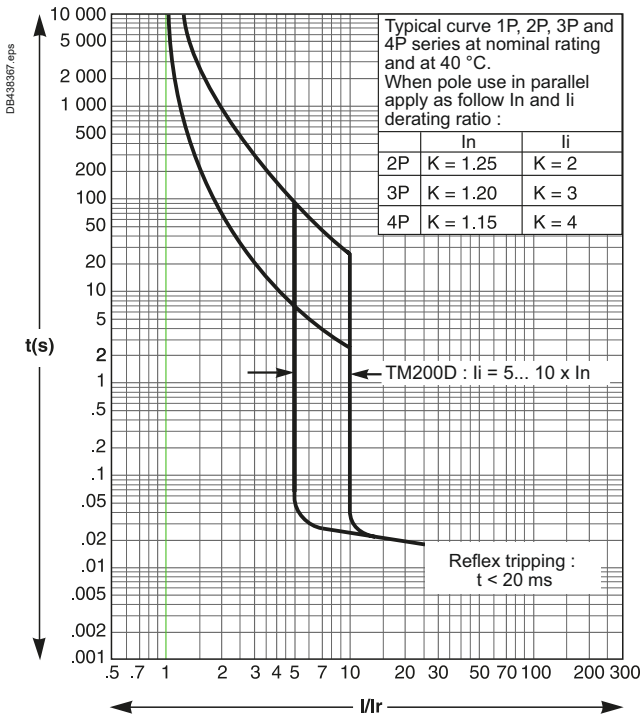

### TM-DC 250

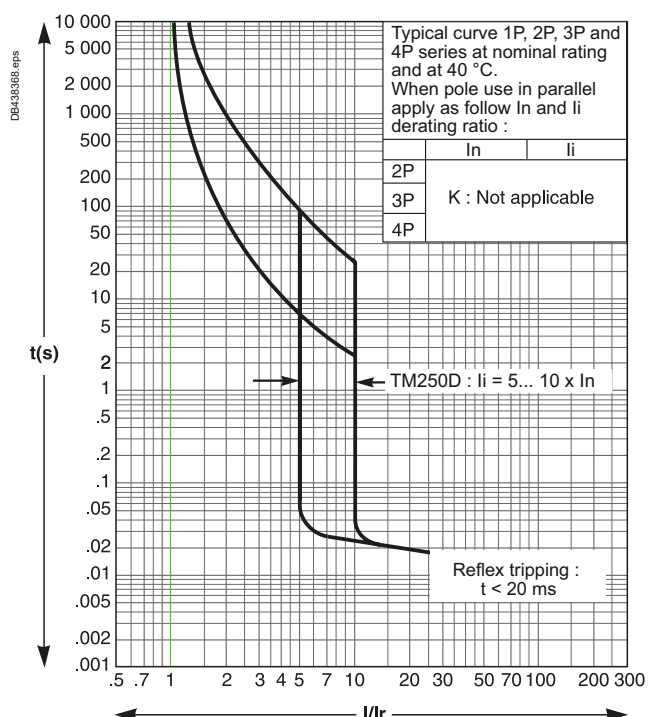

E

# ComCompact NSX100 to 250 DC TMG Magnetic Trip Units, Tripping Curves

## TM16G

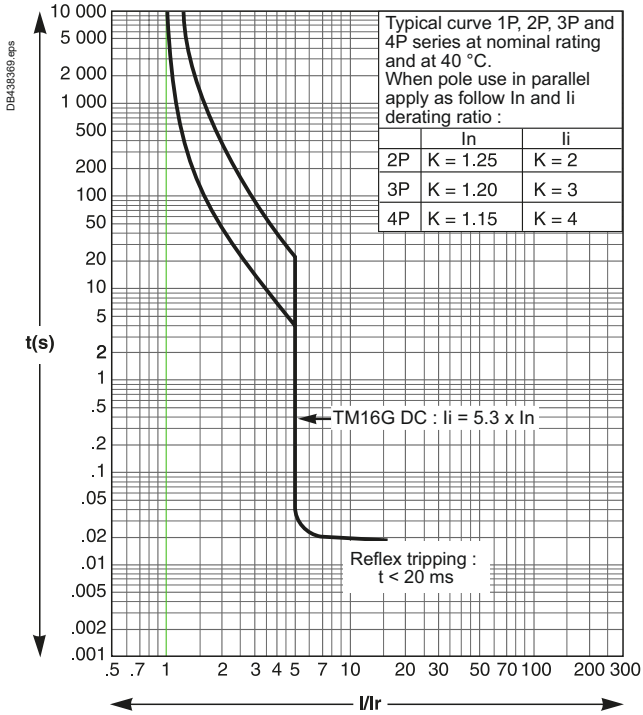

## TM25G

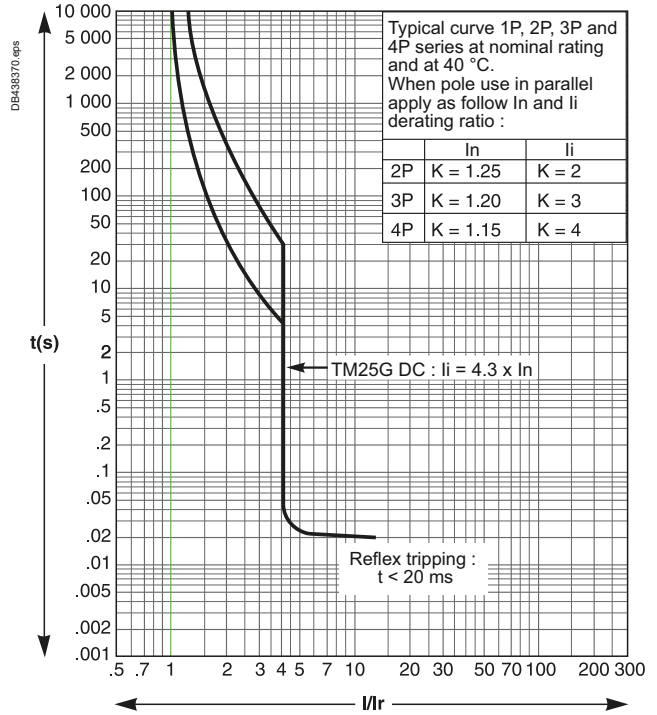

## TM40G

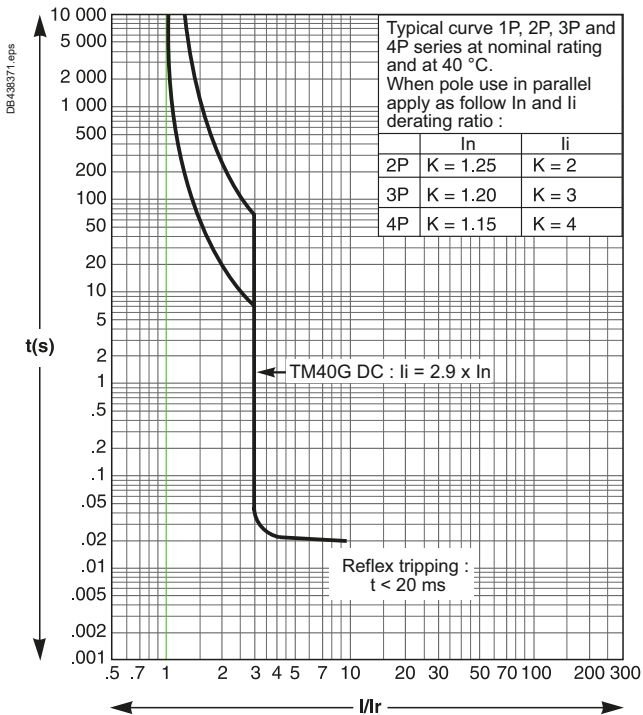

## TM63G

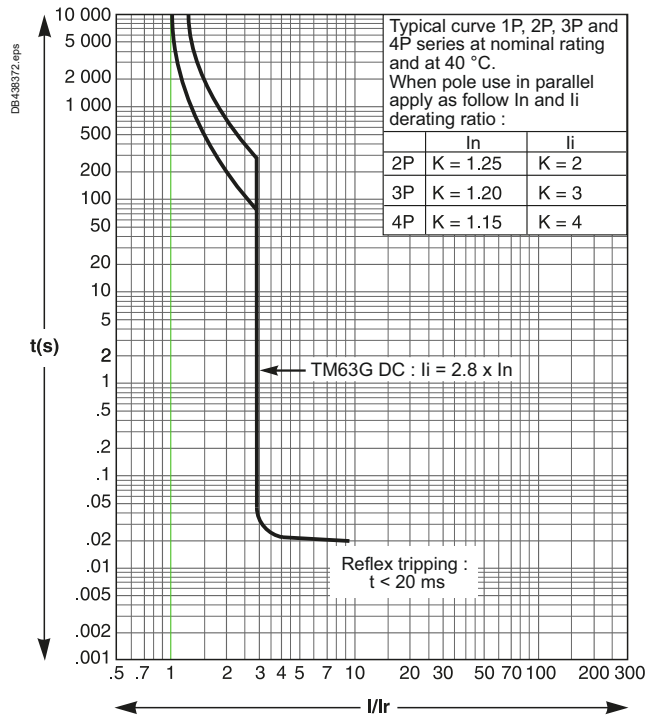

# ComPact NSX100 to 250 DC

## TMG Magnetic Trip Units, Tripping Curves

### TM80G

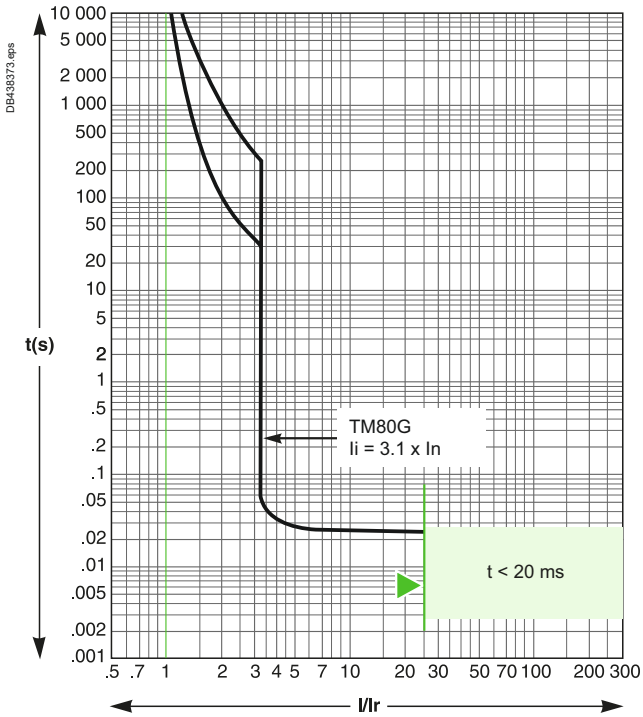

### TM100G

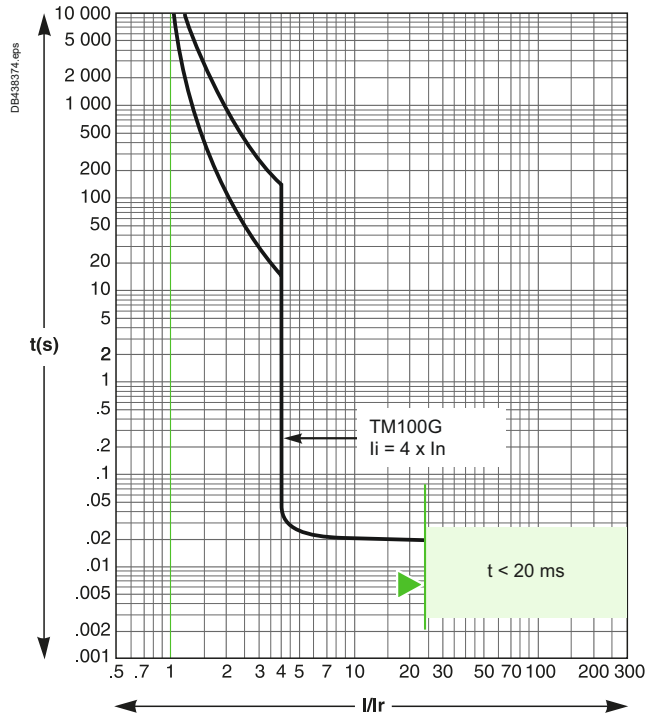

### TM125G

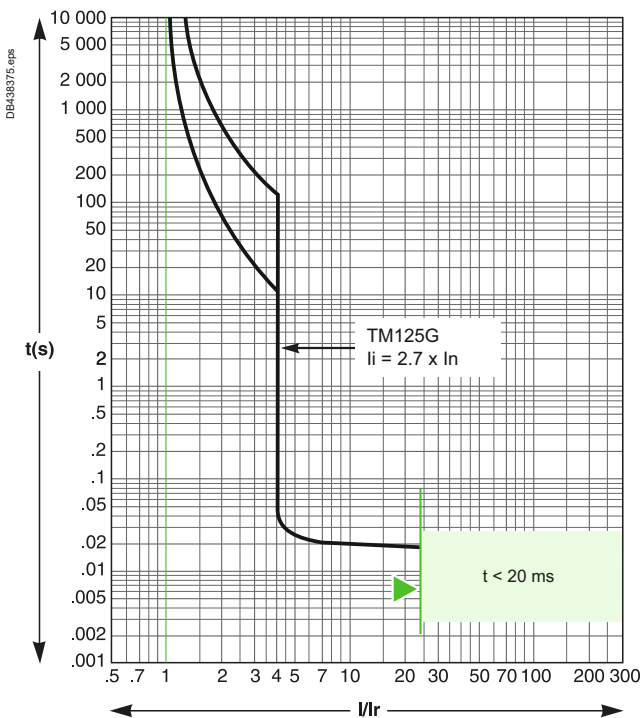

### TM160G

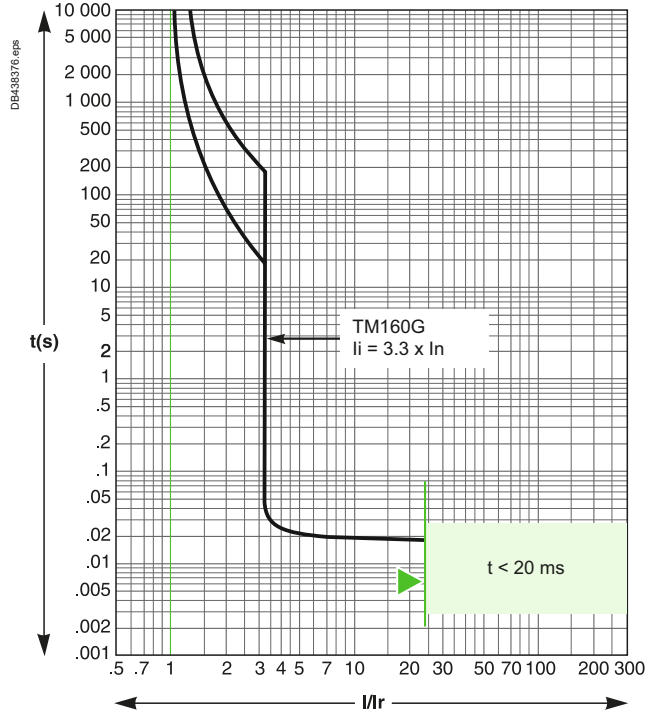

E

# ComPact NSX100 to 250 DC TMG Magnetic Trip Units, Tripping Curves

## TM200G

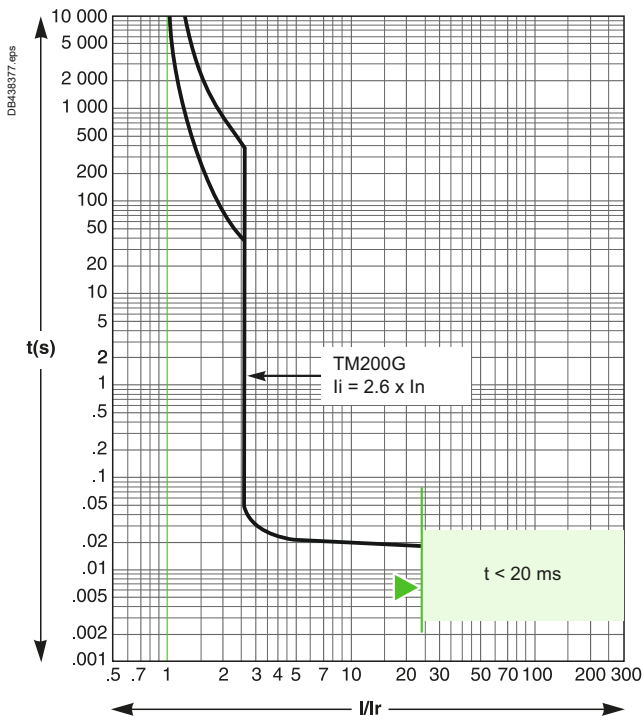

## TM250G

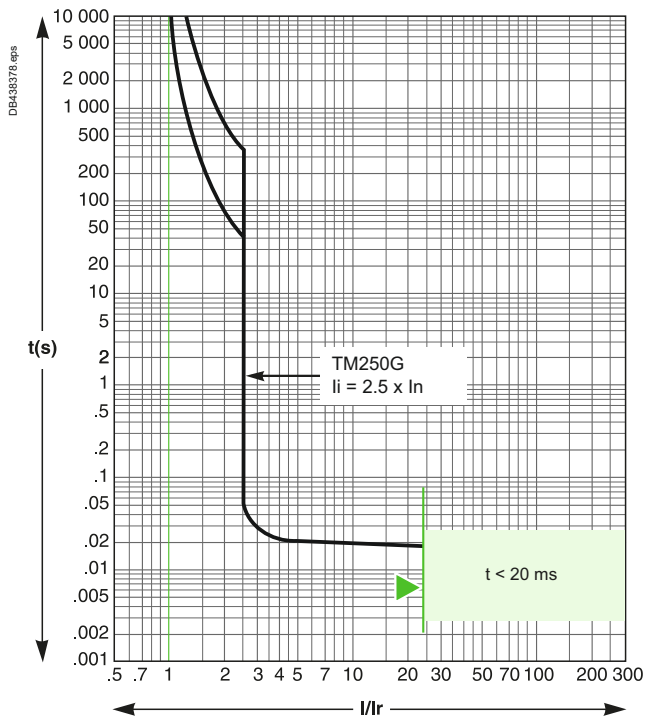

# ComPact NSX400 to 630 DC TM-DC Trip Units, Tripping Curves

## TM-DC 250

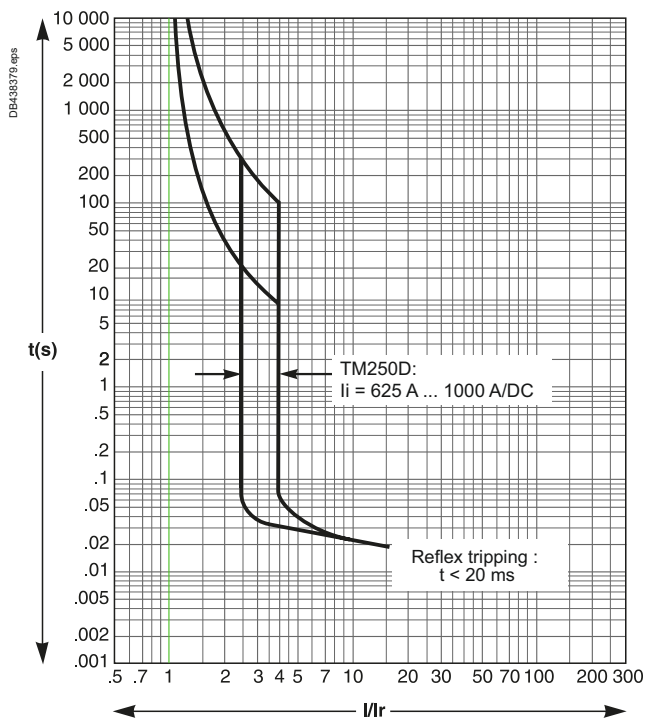

## TM-DC 320

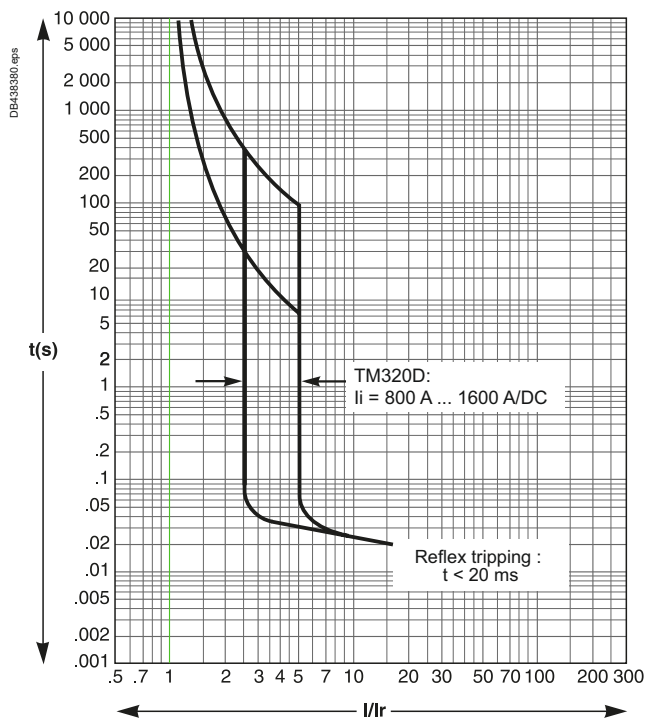

## TM-DC 400

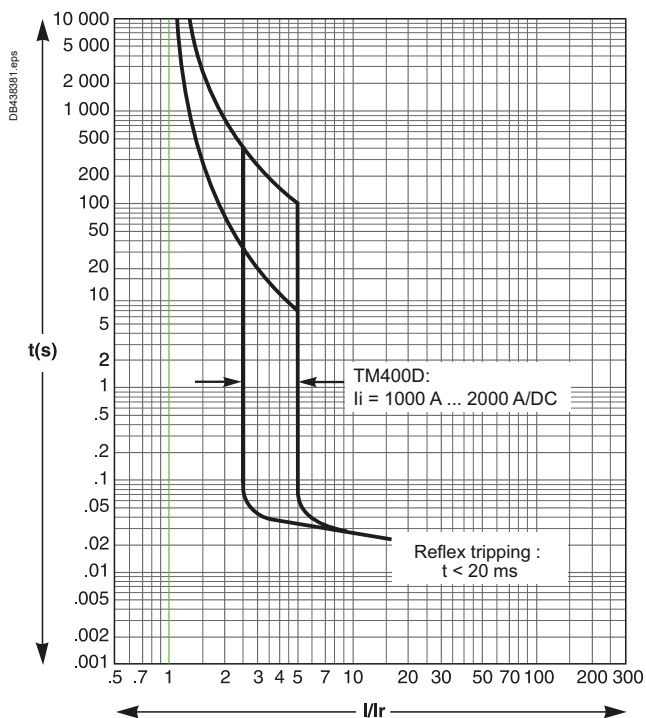

## TM-DC 500

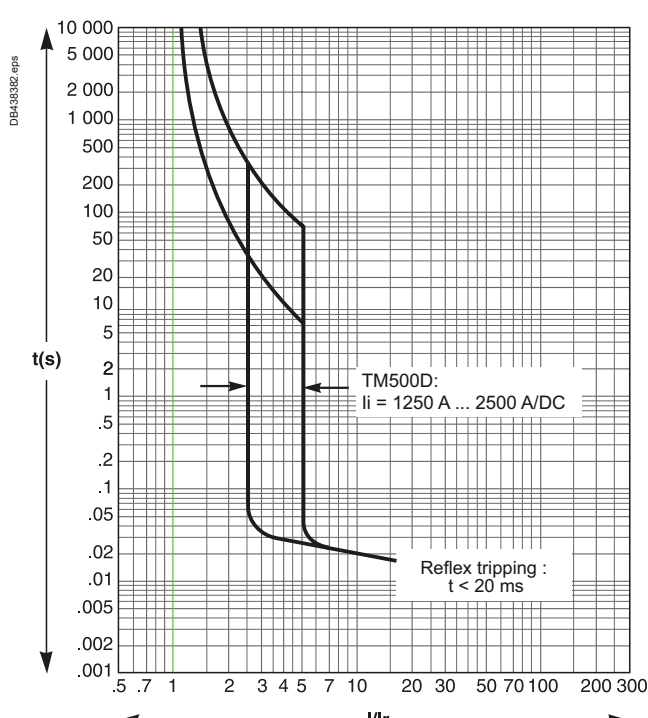

E



# ComPact NSX400 to 630 DC TM-DC Trip Units, Tripping Curves

## TM-DC 600

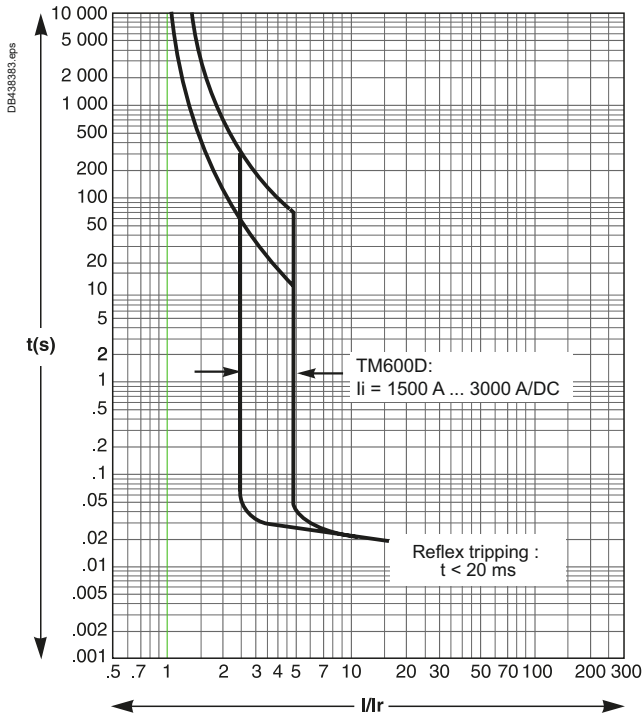

# ComPact NSX630 to 1200 DC TM-DC Trip Units, Tripping Curves

## TM-DC 630

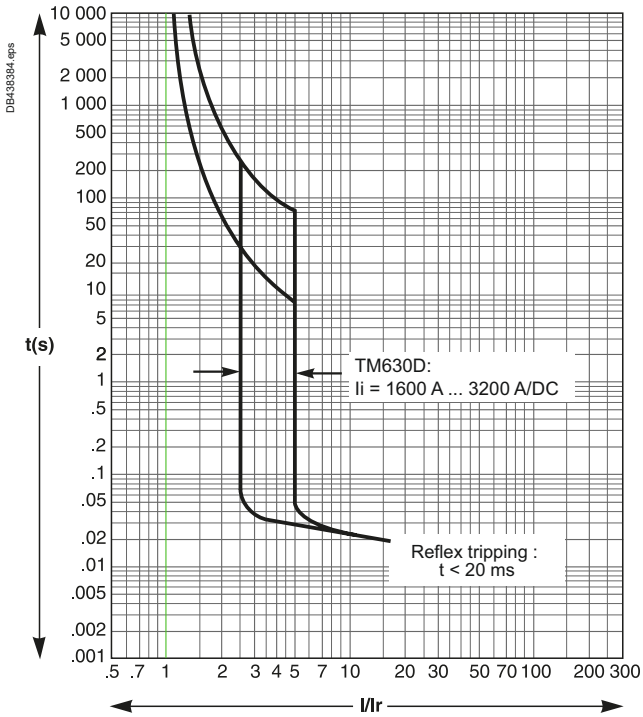

## TM-DC 800

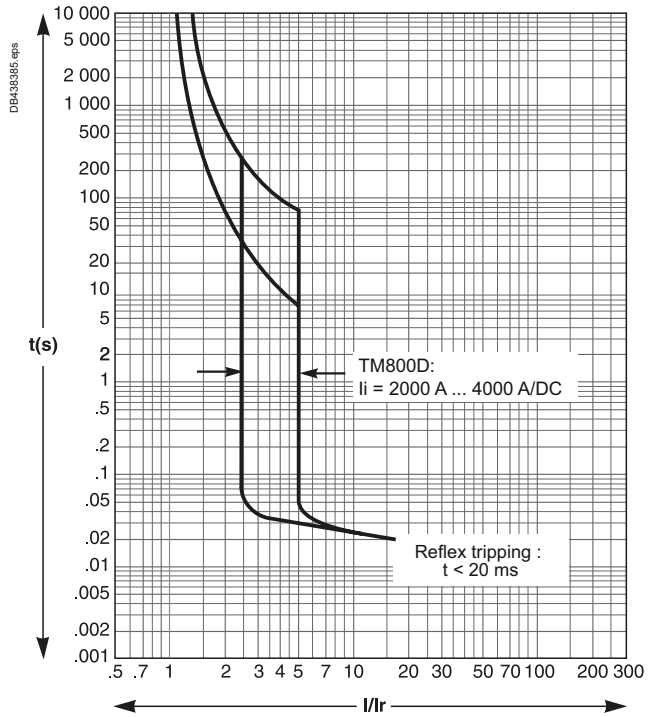

## TM-DC 1000

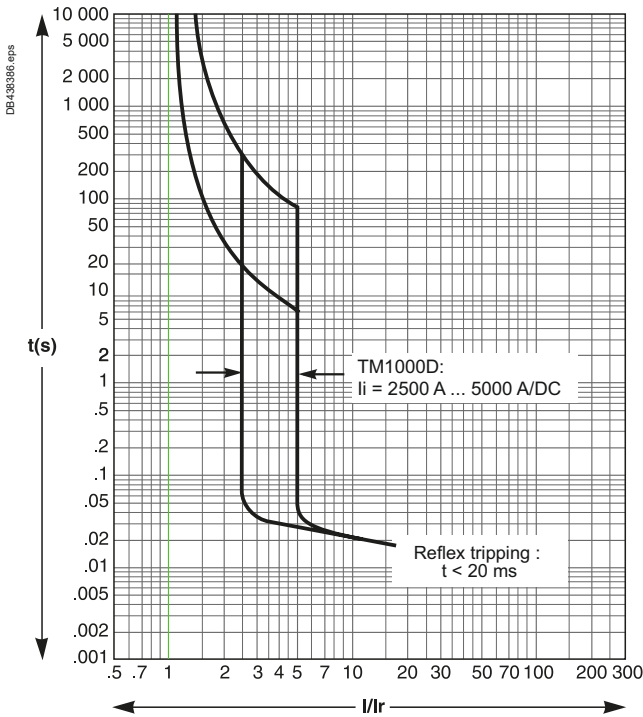

## TM-DC 1200

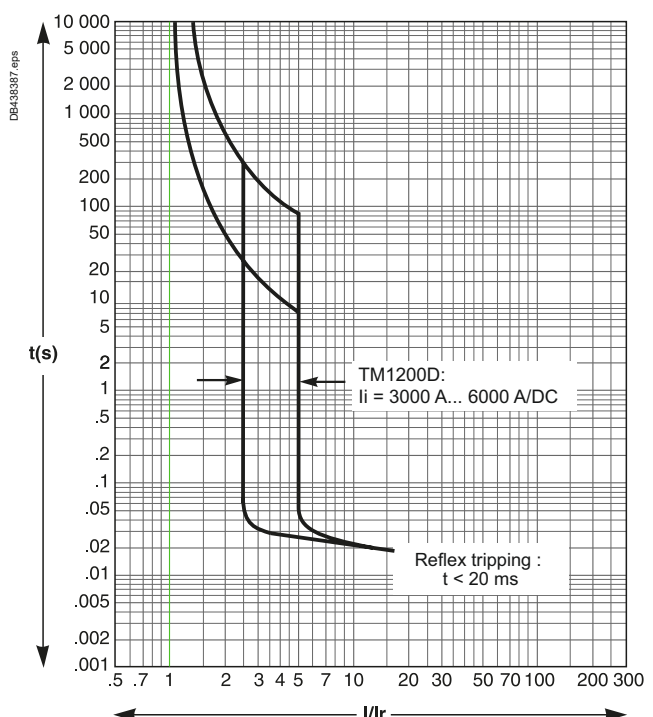

E

# ComPacT NSX80 to 500 DC PV TM-DC PV Magnetic Trip Units, Tripping Curves

## TM-DC PV 80

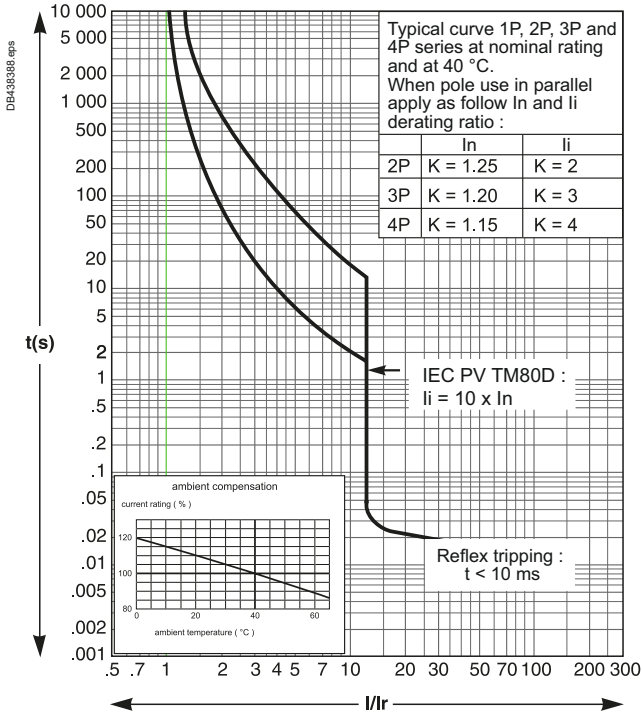

## TM-DC PV 125

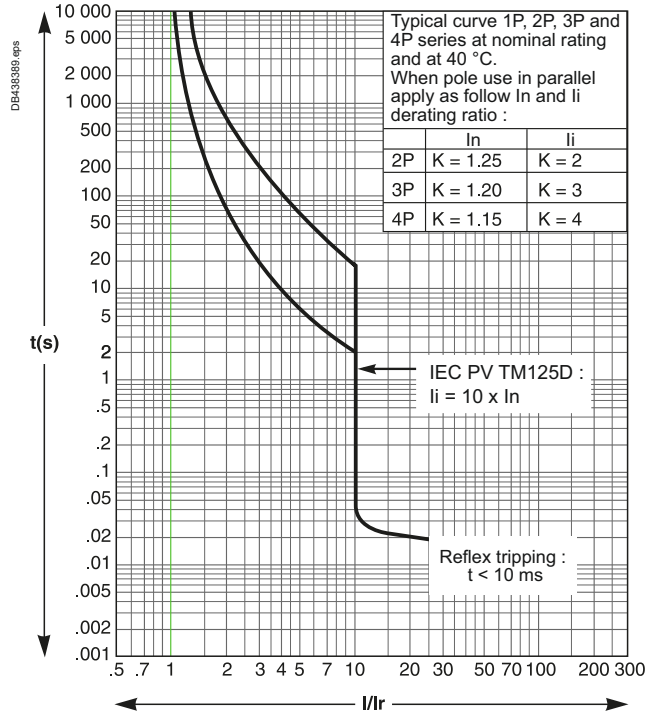

## TM-DC PV 160

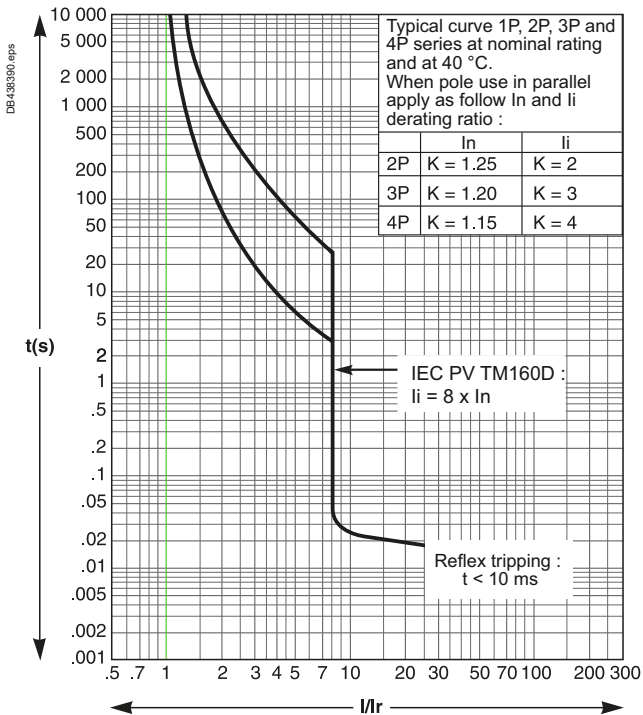

## TM-DC PV 200

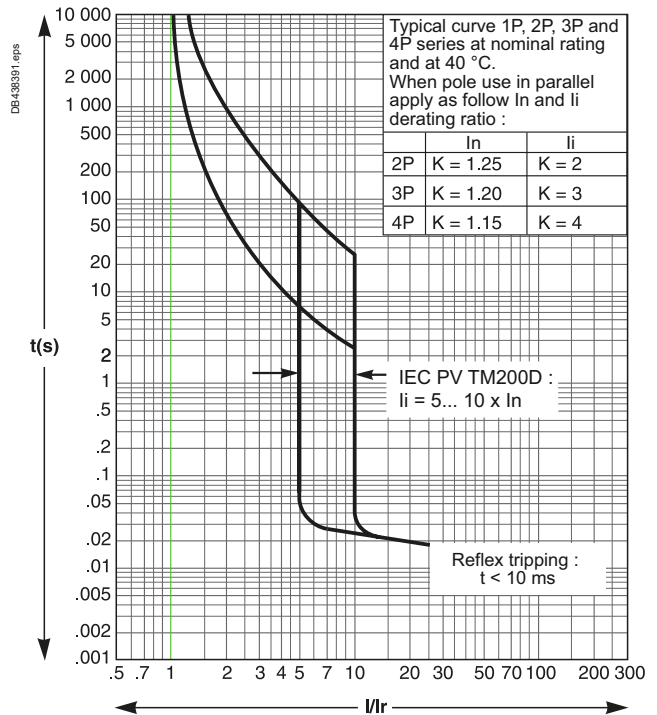

# ComPacT NSX80 to 500 DC PV

## TM-DC PV Magnetic Trip Units, Tripping Curves

### TM-DC PV 250

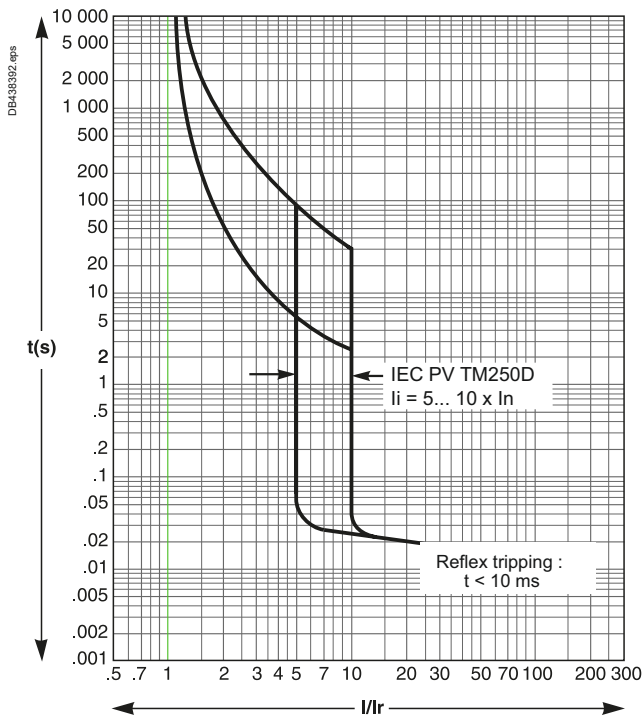

### TM-DC PV 320/400

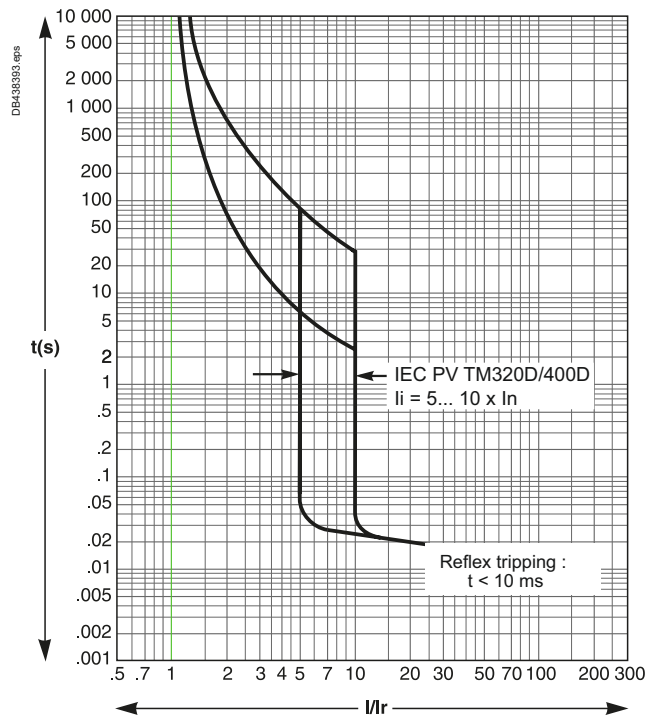

### TM-DC PV 500

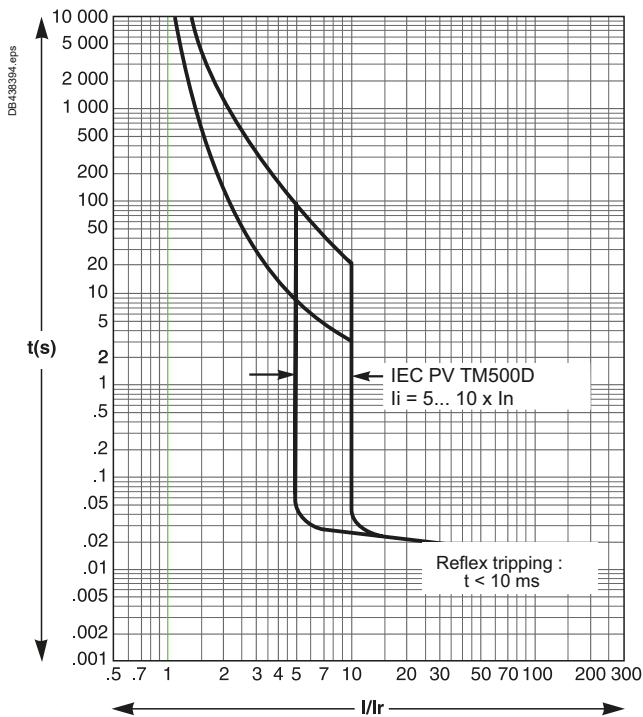

E

# Current and Energy Limiting Curves

The limiting capacity of a circuit breaker is its aptitude to let through a current, during a short-circuit, that is less than the prospective short-circuit current.

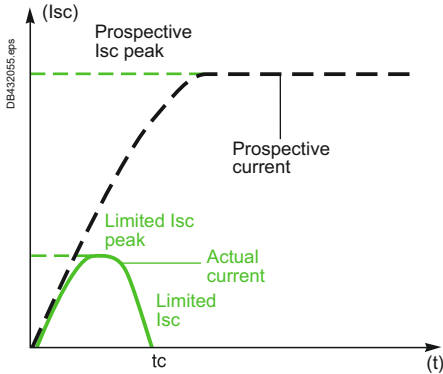

The exceptional limiting capacity of the ComPacT NSX DC range is due to the rotating double-break technique (very rapid natural repulsion of contacts and the appearance of two arc voltages in-series with a very steep wave front).

## Ics = 100 % Icu

The exceptional limiting capacity of the ComPacT NSX DC range greatly reduces the forces created by fault currents in devices.

The result is a major increase in breaking performance.

In particular, the service breaking capacity Ics is equal to 100 % of Icu.

The Ics value, defined by IEC standard 60947-2, is ensured by tests comprising the following steps:

- Break three times consecutively a fault current equal to 100 % of Icu
- Check that the device continues to function normally, that is:
  - It conducts the rated current without abnormal temperature rise
  - Protection functions perform within the limits specified by the standard
  - Suitability for isolation is not impaired.

## Longer Service Life of Electrical Installations

Current-limiting circuit breakers greatly reduce the negative effects of short-circuits on installations.

### Thermal Effects

Less temperature rise in conductors, therefore longer service life for cables.

### Mechanical Effects

Reduced electrodynamic forces, therefore less risk of electrical contacts or busbars being deformed or broken.

### Electromagnetic Effects

Fewer disturbances for measuring devices located near electrical circuits.

## Current and Energy Limiting Curves

The limiting capacity of a circuit breaker is expressed by two curves which are a function of the prospective short-circuit current (the current which would flow if no protection devices were installed):

- The actual peak current (limited current)
- Thermal stress (A<sup>2</sup>s), i.e. the energy dissipated by the short-circuit in a conductor with a resistance of 1 Ω.

### Example

What is the real value of a 150 kA rms prospective short-circuit (i.e. 330 kA peak) limited by an NSX250L DC upstream ?

The answer is 30 kA peak (curve [page E-14](#)).

## Maximum Permissible Cable Stresses

The table below indicates the maximum permissible thermal stresses for cables depending on their insulation, conductor (Cu or Al) and their cross-sectional area (CSA). CSA values are given in mm<sup>2</sup> and thermal stresses in A<sup>2</sup>s.

CSA		1.5 mm <sup>2</sup>	2.5 mm <sup>2</sup>	4 mm <sup>2</sup>	6 mm <sup>2</sup>	10 mm <sup>2</sup>
PVC	Cu	2.97 x 10 <sup>4</sup>	8.26 x 10 <sup>4</sup>	2.12 x 10 <sup>5</sup>	4.76 x 10 <sup>5</sup>	1.32 x 10 <sup>6</sup>
	Al					5.41 x 10 <sup>5</sup>
PRC	Cu	4.10 x 10 <sup>4</sup>	1.39 x 10 <sup>5</sup>	2.92 x 10 <sup>5</sup>	6.56 x 10 <sup>5</sup>	1.82 x 10 <sup>6</sup>
	Al					7.52 x 10 <sup>5</sup>
CSA		16 mm <sup>2</sup>	25 mm <sup>2</sup>	35 mm <sup>2</sup>	50 mm <sup>2</sup>	
PVC	Cu	3.4 x 10 <sup>6</sup>	8.26 x 10 <sup>6</sup>	1.62 x 10 <sup>7</sup>	3.31 x 10 <sup>7</sup>	
	Al	1.39 x 10 <sup>6</sup>	3.38 x 10 <sup>6</sup>	6.64 x 10 <sup>6</sup>	1.35 x 10 <sup>7</sup>	
PRC	Cu	4.69 x 10 <sup>6</sup>	1.39 x 10 <sup>7</sup>	2.23 x 10 <sup>7</sup>	4.56 x 10 <sup>7</sup>	
	Al	1.93 x 10 <sup>6</sup>	4.70 x 10 <sup>6</sup>	9.23 x 10 <sup>6</sup>	1.88 x 10 <sup>7</sup>	

### Example

Is a Cu/PVC cable with a CSA of 10 mm<sup>2</sup> adequately protected by an NSX160F.

The table above indicates that the permissible stress is 1.32x10<sup>6</sup> A<sup>2</sup>s.

All short-circuit currents at the point where an NSX160F (Icu = 35 kA) is installed are limited with a thermal stress less than 6x10<sup>5</sup> A<sup>2</sup>s (curve [page E-14](#)).

Cable protection is therefore ensured up to the limit of the breaking capacity of the circuit breaker.



# Current and energy limiting curves ComPact NSX DC

## Current-limiting curves and thermal stress for L/R = 5 ms

Peak current  
 U < 250 V DC: 1P  
 250 V < U < 500 V DC: 2P  
 500 V < U < 750 V DC: 3P

Thermal stress  
 U < 250 V DC: 1P  
 250 V < U < 500 V DC: 2P

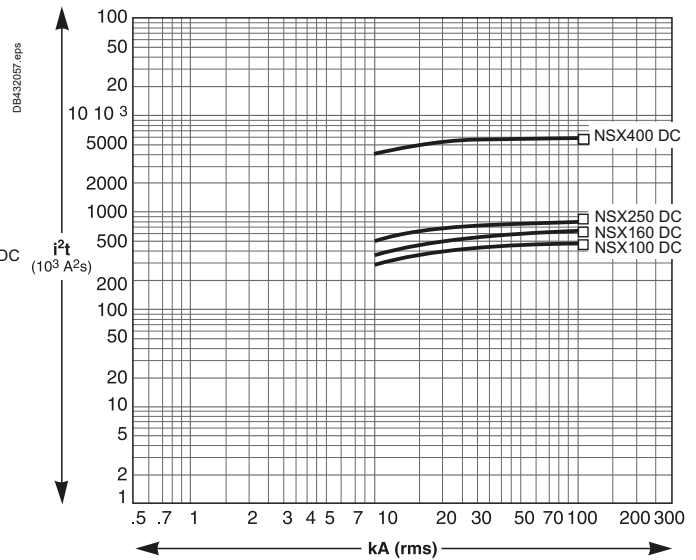
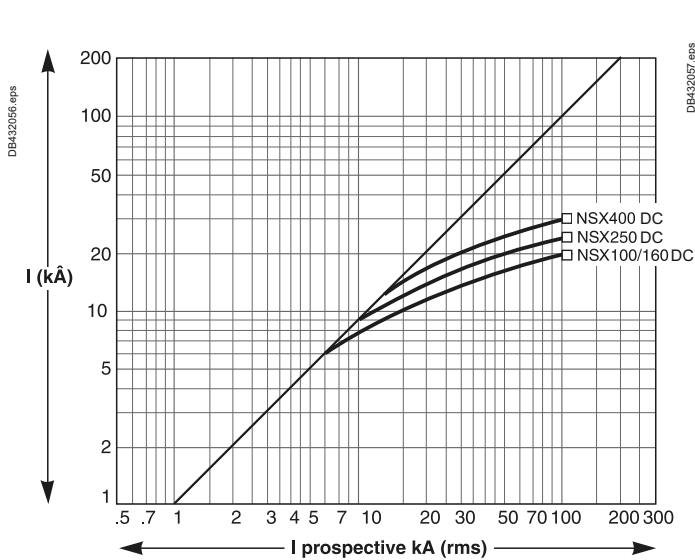

## Current-limiting curves and thermal stress for L/R = 15 ms

Peak current  
 U < 250 V DC: 1P  
 250 V < U < 500 V DC: 2P  
 500 V < U < 750 V DC: 3P

Thermal stress  
 U < 250 V DC: 1P  
 250 V < U < 500 V DC: 2P

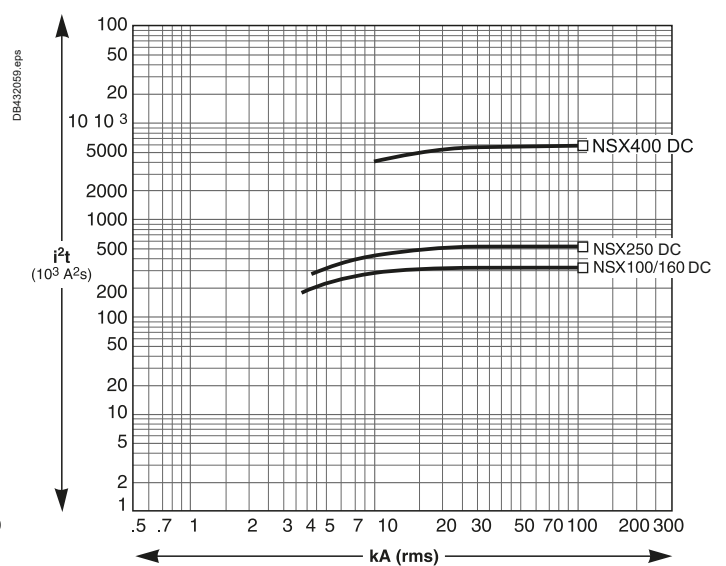
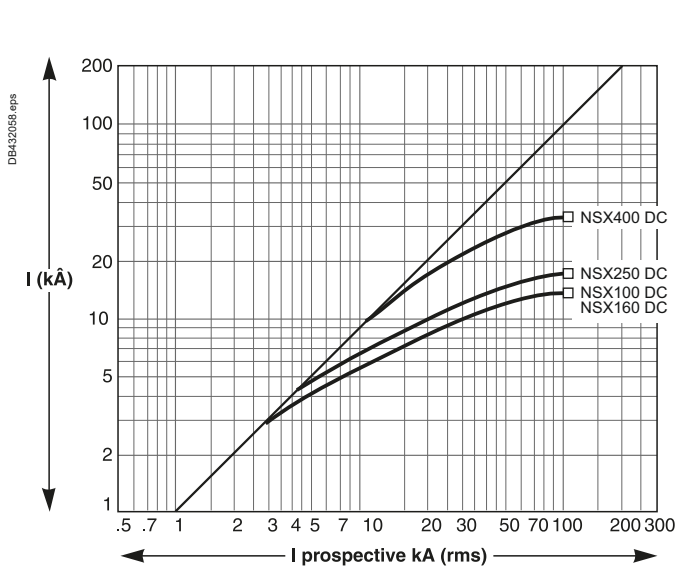

E

# Current and energy limiting curves ComPact NSX DC

## Current-limiting curves and thermal stress for L/R = 5 ms

Peak current  
 $U \leq 250$  V DC: 1P  
 $250$  V <  $U$  <  $600$  V DC: 2P  
 $600$  V <  $U$  <  $750$  V DC: 3P

Thermal stress  
 $U \leq 250$  V DC: 1P  
 $250$  V <  $U$  <  $600$  V DC: 2P

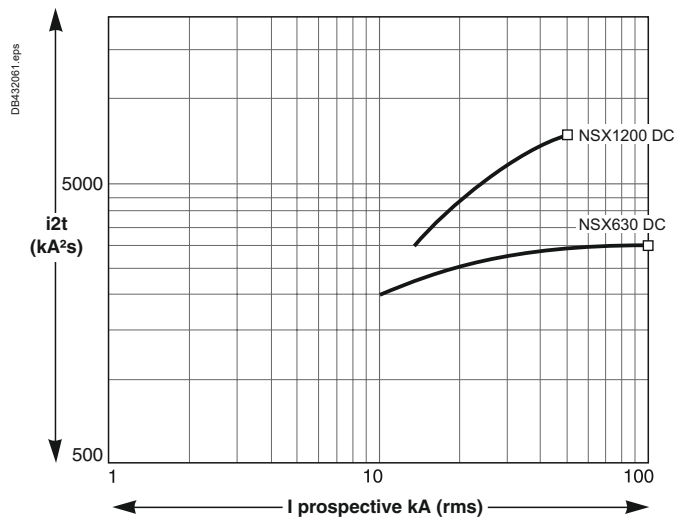
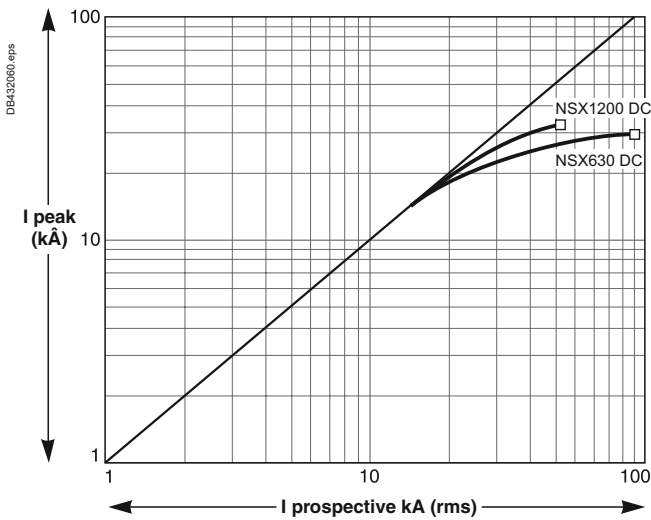

## Current-limiting curves and thermal stress for L/R = 15 ms

Peak current  
 $U \leq 250$  V DC: 1P  
 $250$  V <  $U$  <  $600$  V DC: 2P  
 $600$  V <  $U$  <  $750$  V DC: 3P

Thermal stress  
 $U \leq 250$  V DC: 1P  
 $250$  V <  $U$  <  $600$  V DC: 2P

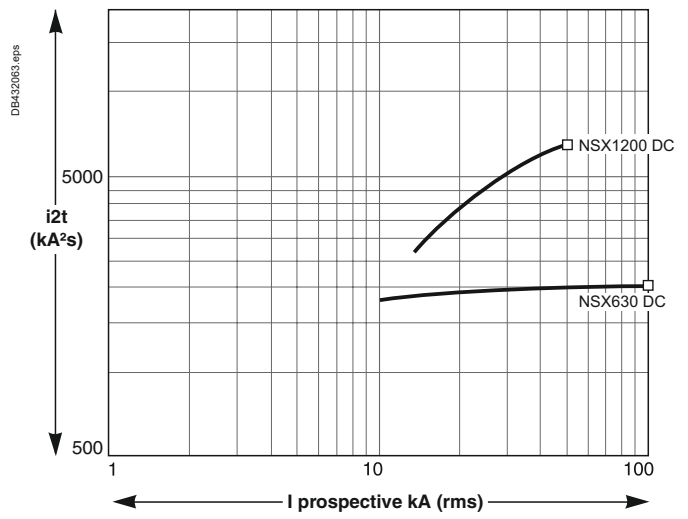
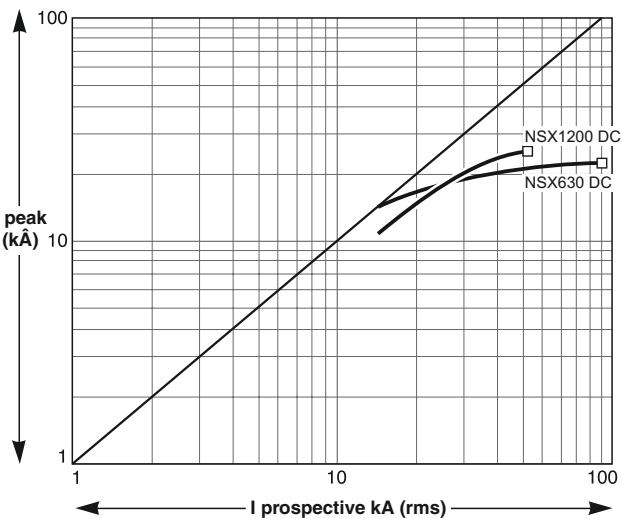



# Current and Energy Limiting Curves ComPacT NSX DC EP

**NSX250DC EP TM100D**

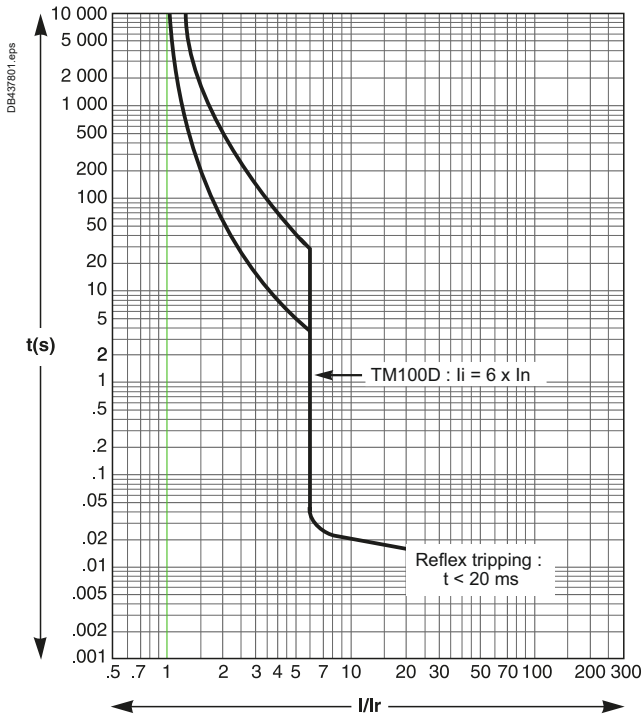

**NSX250DC EP TM125D**

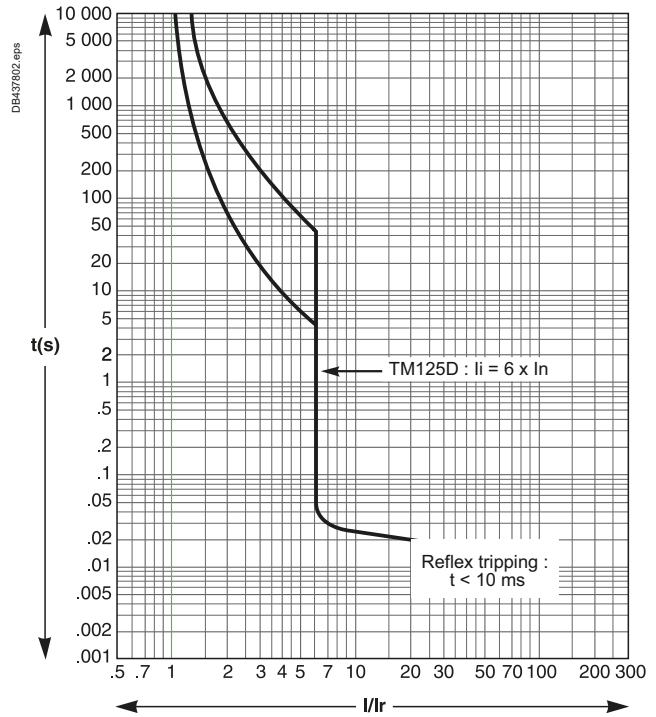

**NSX250DC EP TM160D**

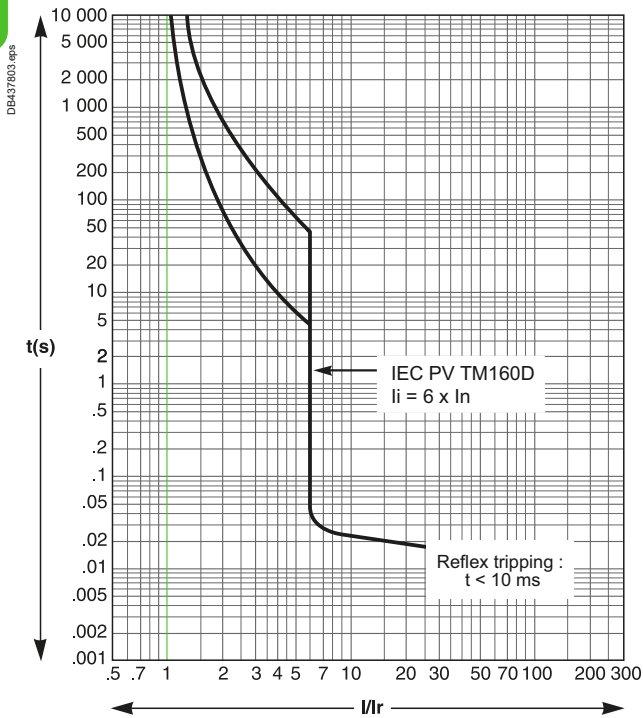

**NSX250DC EP TM200D**

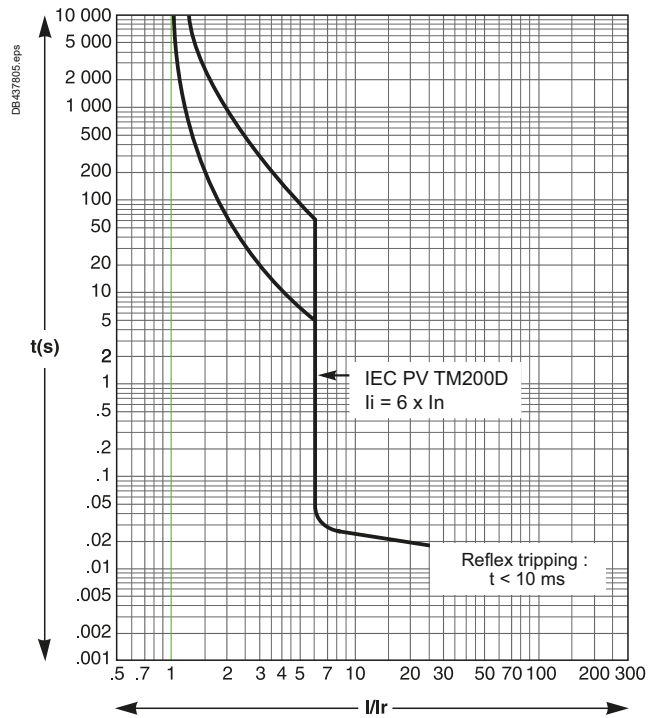

E

# Current and Energy Limiting Curves ComPacT NSX DC EP

**NSX250DC EP TM250D**

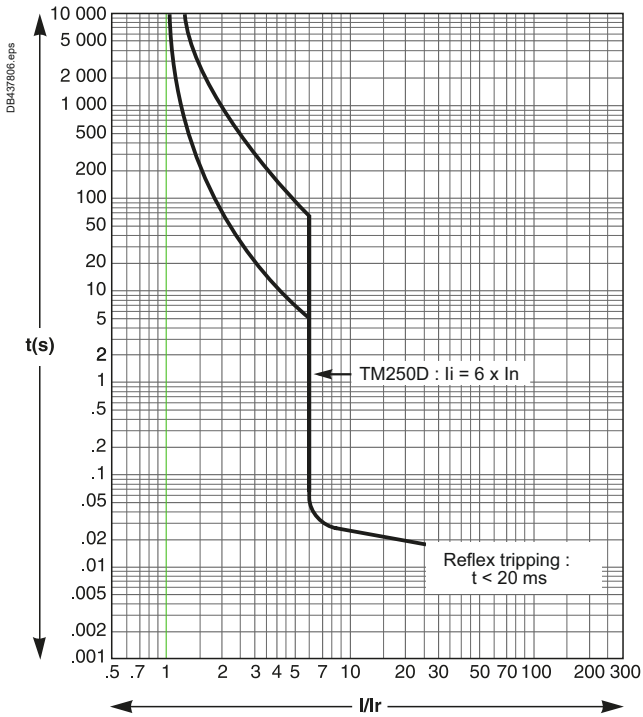

**NSX500DC EP TM250D**

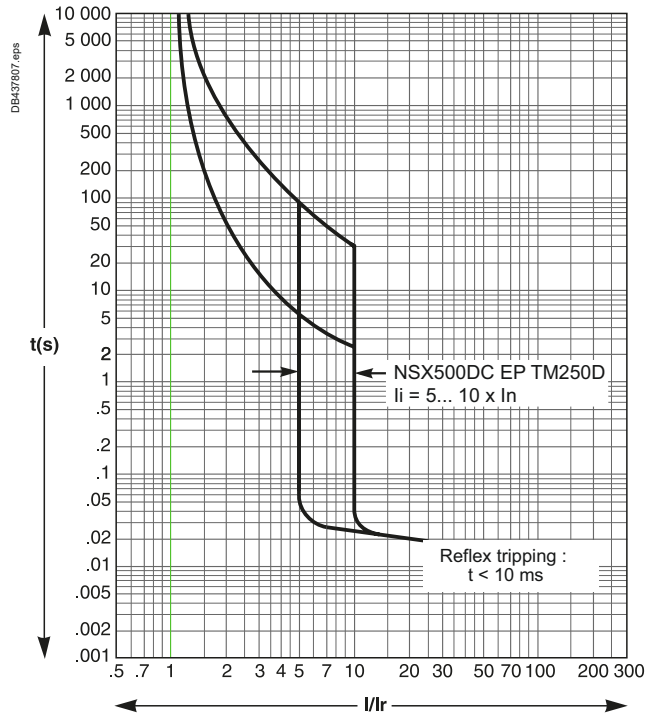

**NSX500DC EP TM320/400D**

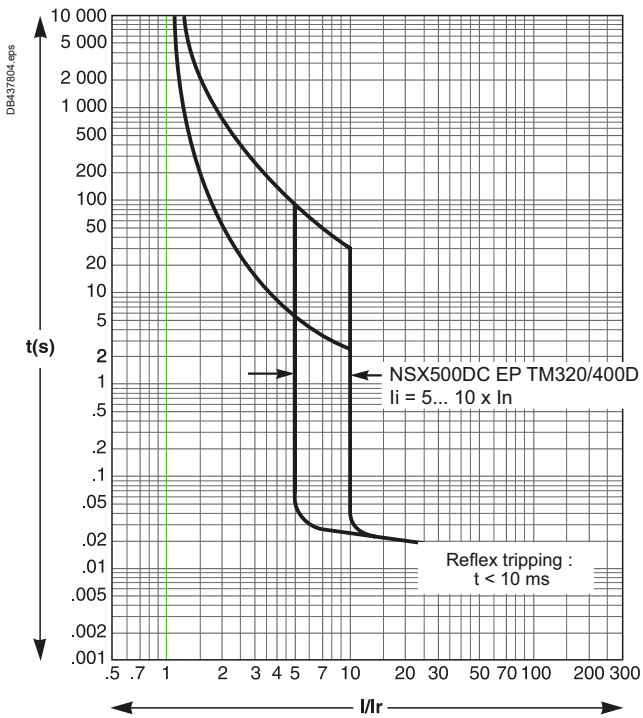

**NSX500DC EP TM500D**

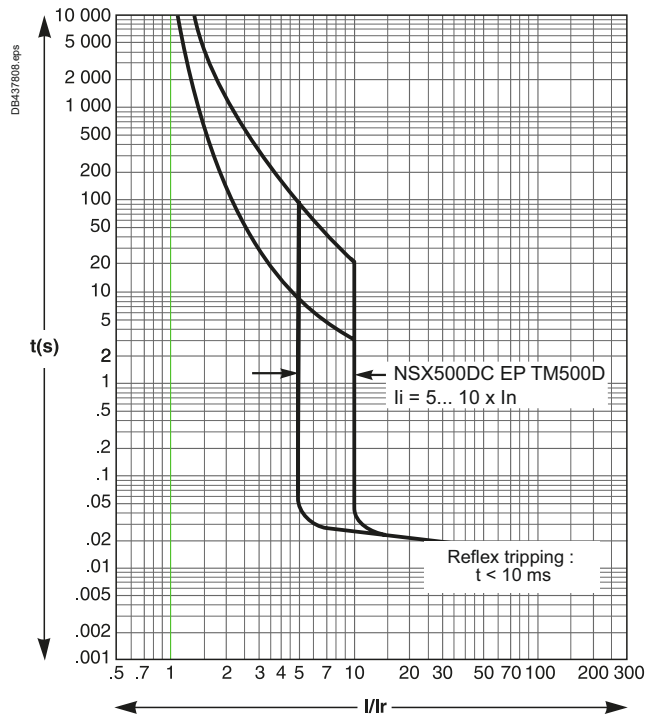

# MasterPact NW10 to NW40 DC

## Tripping Curves

U = 500 V DC, L/R = 5 Ms

### MicroLogic DC 1.0 Instantaneous Protection

With 1250 - 2500 A Sensors

With 2500 - 5400 A Sensors

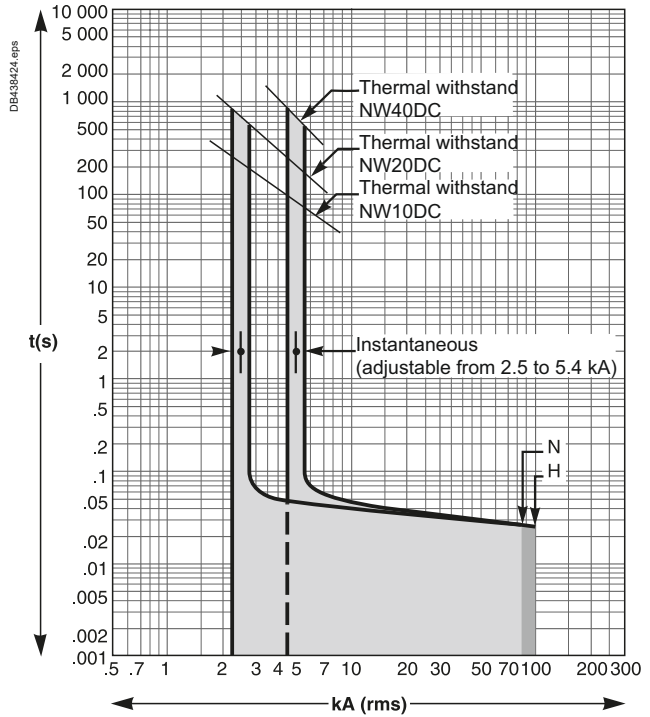
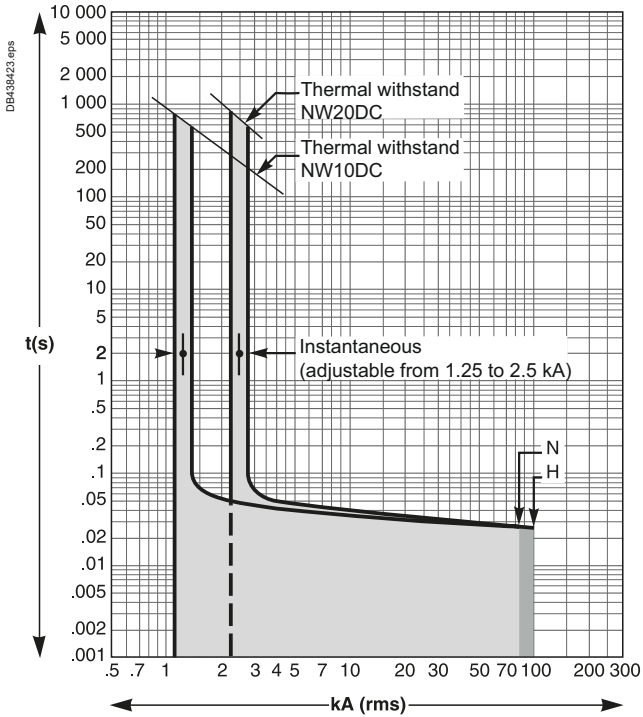

E

### With 5000 - 11000 A Sensors

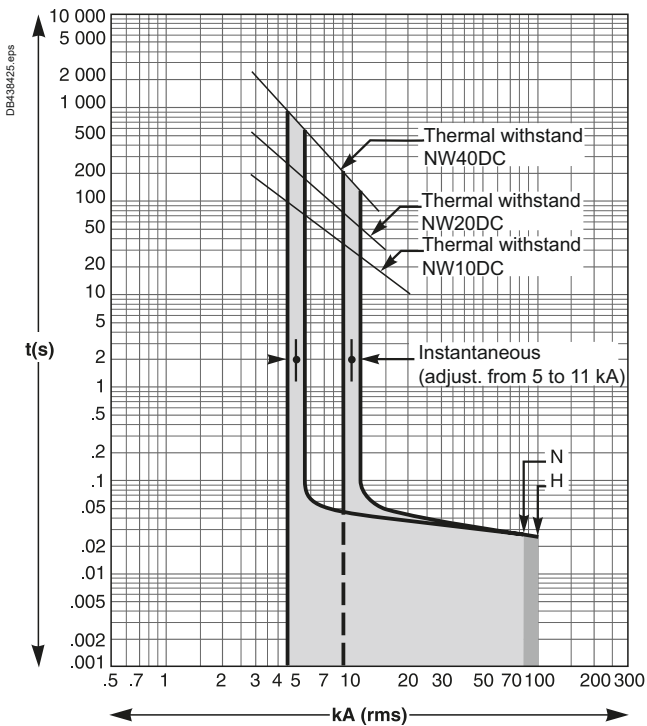

# MasterPact NW10 to NW40 DC

## Tripping Curves

$U = 750/900 \text{ V DC}, L/R = 5 \text{ Ms}$

### MicroLogic DC 1.0 Instantaneous Protection

With 1250 - 2500 A Sensors

With 2500 - 5400 A Sensors

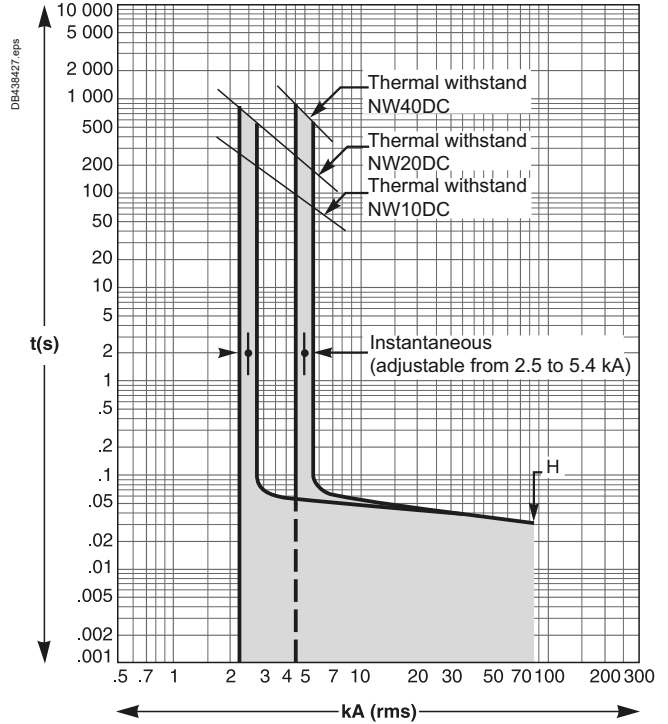
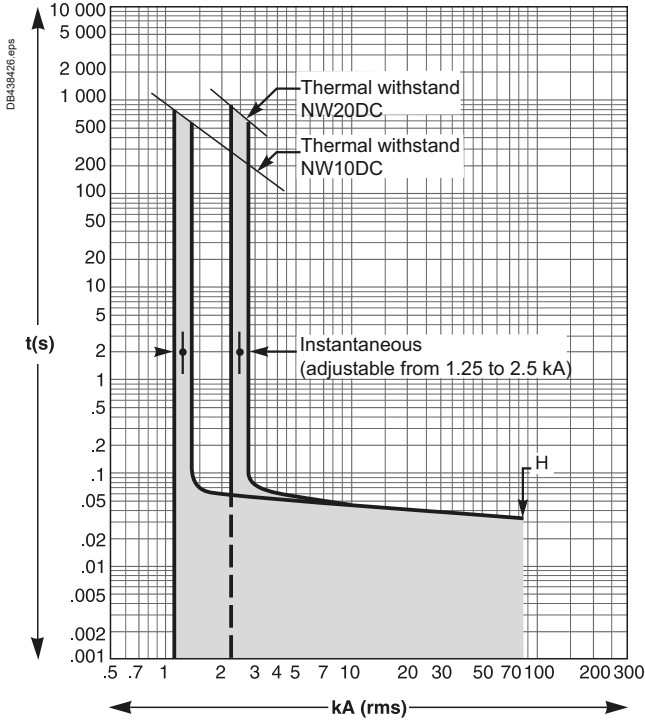

With 5000 - 11000 A Sensors

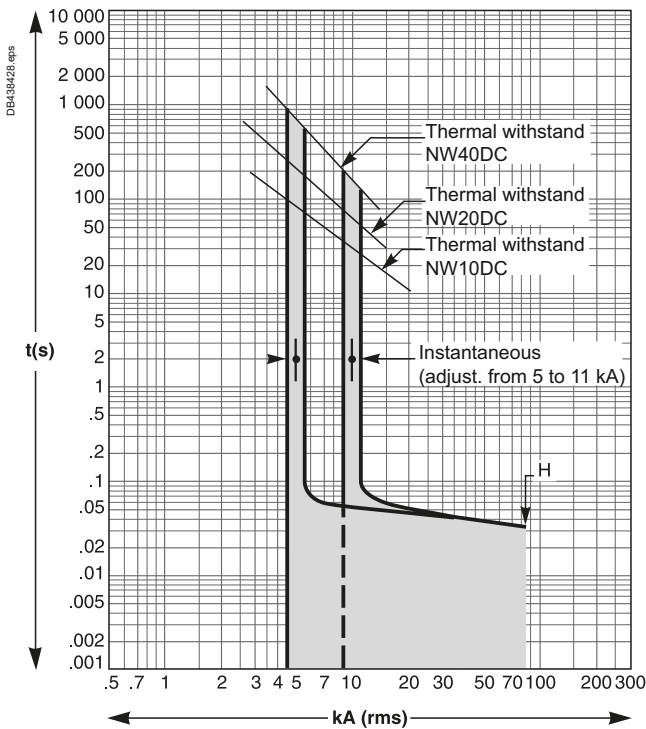

# MasterPact NW10 to NW40 DC

## Tripping Curves

U = 500 V DC, L/R = 15 Ms

### MicroLogic DC 1.0 Instantaneous Protection

With 1250 - 2500 A Sensors

With 2500 - 5400 A Sensors

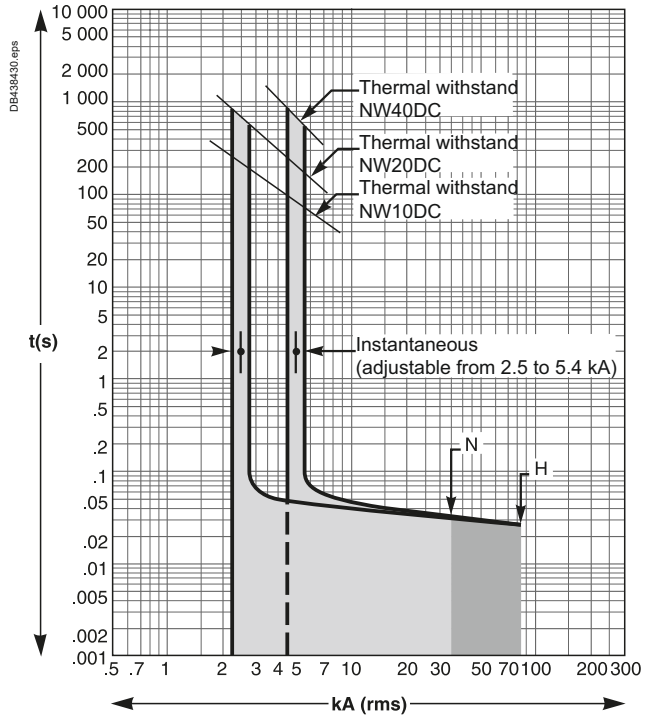
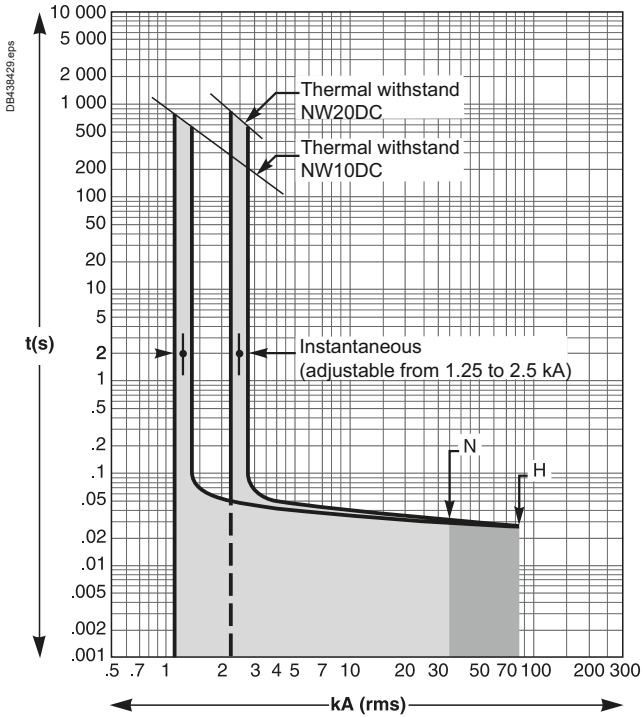

E

With 5000 - 11000 A Sensors

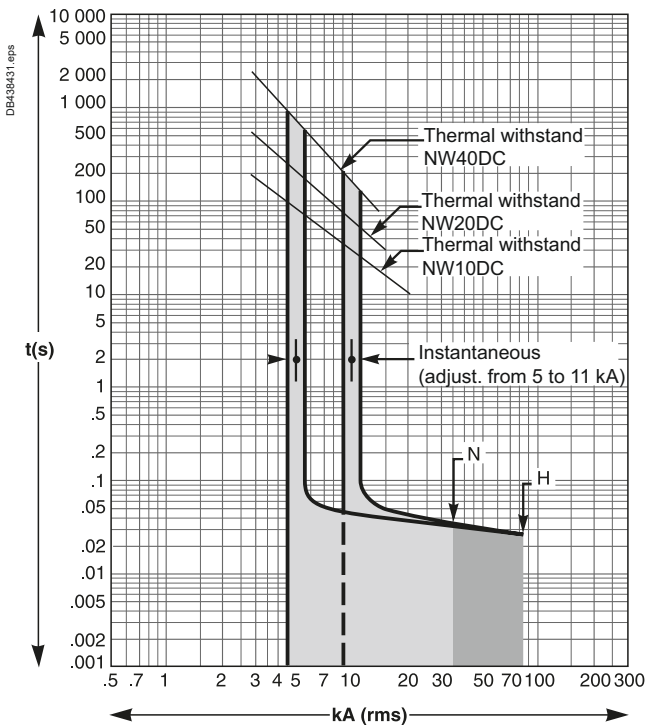

# MasterPact NW10 to NW40 DC

## Tripping Curves

U = 750/900 V DC, L/R = 15 Ms

### MicroLogic DC 1.0 Instantaneous Protection

With 1250 - 2500 A Sensors

With 2500 - 5400 A Sensors

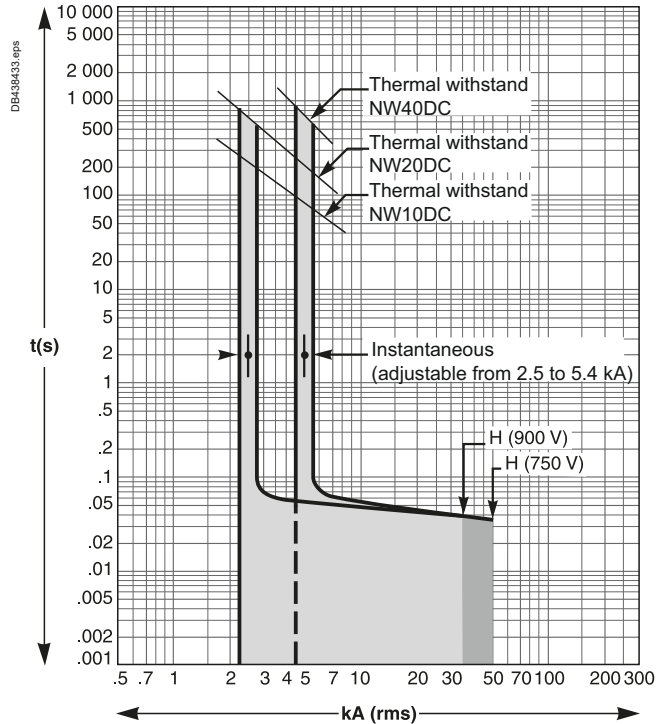
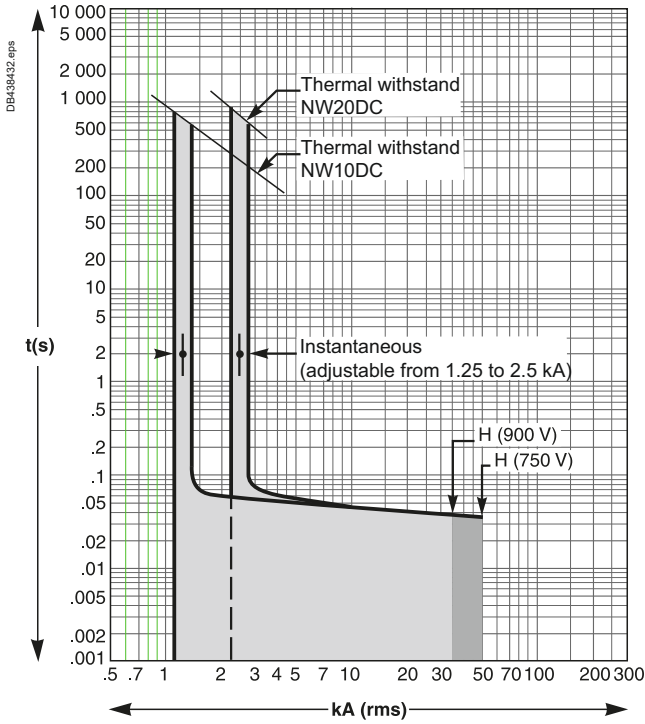

### With 5000 - 11000 A Sensors

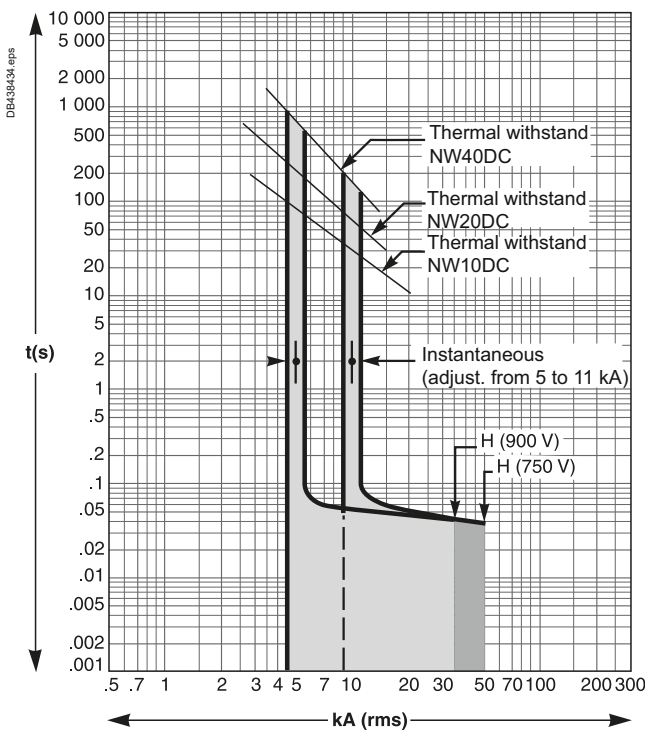

# MasterPact NW10 to NW40 DC

## Tripping Curves

U = 500/750 V DC, L/R = 30 Ms

### MicroLogic DC 1.0 Instantaneous Protection

With 1250 - 2500 A Sensors

With 2500 - 5400 A Sensors

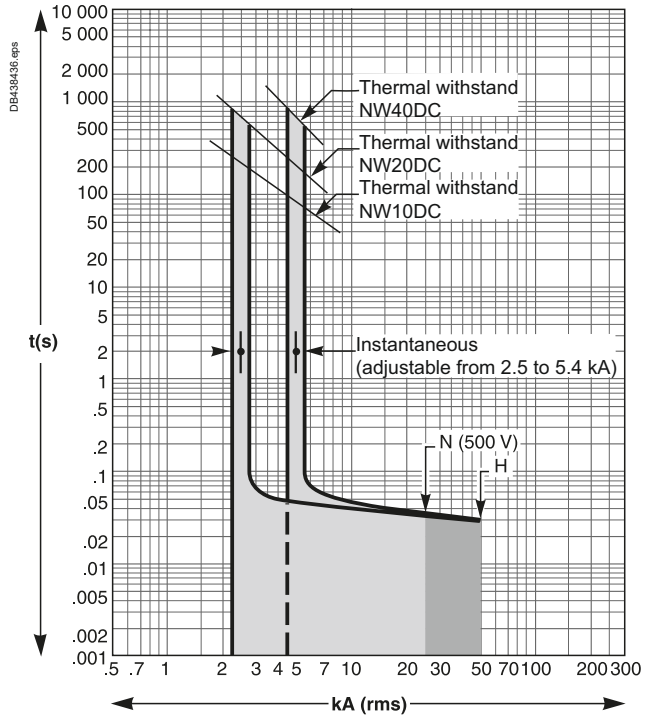
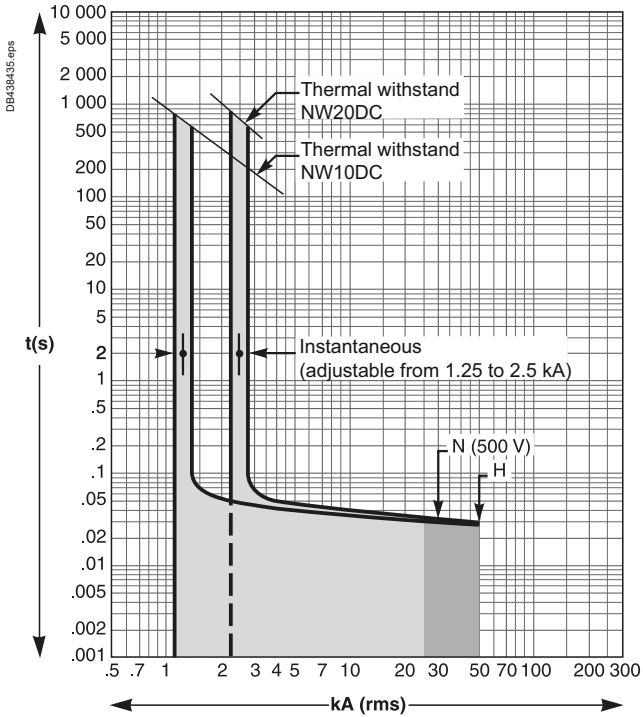

E

### With 5000 - 11000 A Sensors

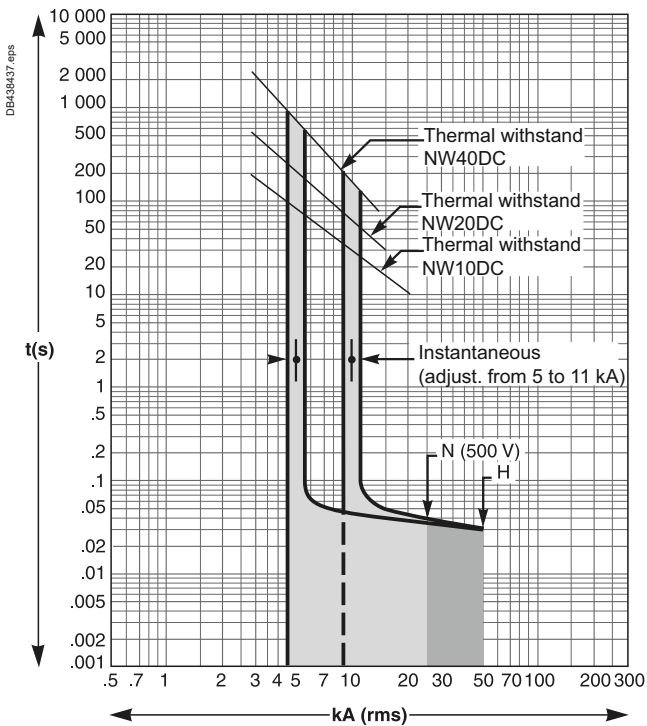



# MasterPact NW10 to NW40 DC

## Tripping Curves

U = 900 V DC, L/R = 30 Ms

### MicroLogic DC 1.0 Instantaneous Protection

With 1250 - 2500 A Sensors

With 2500 - 5400 A Sensors

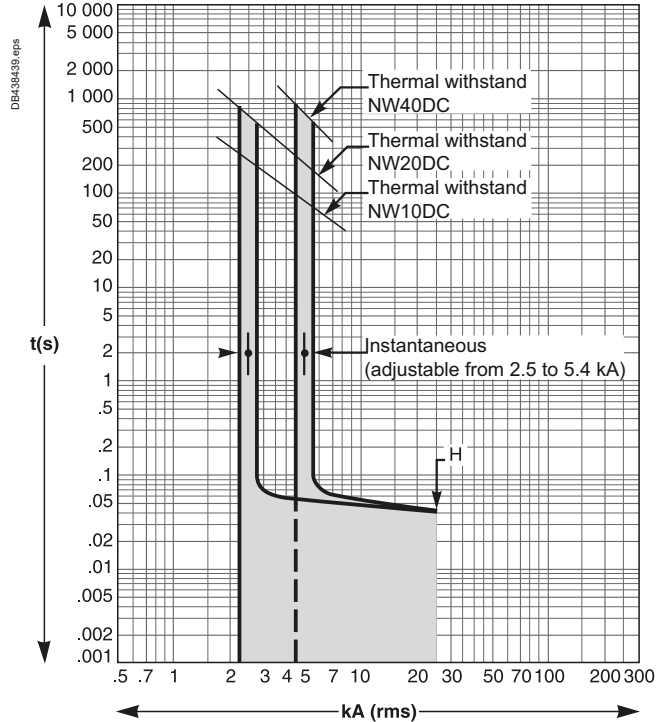
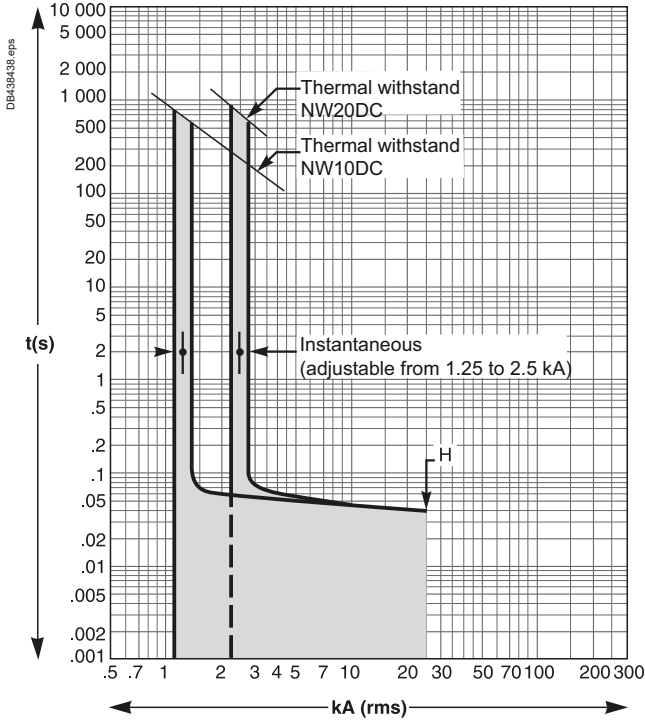

With 5000 - 11000 A Sensors

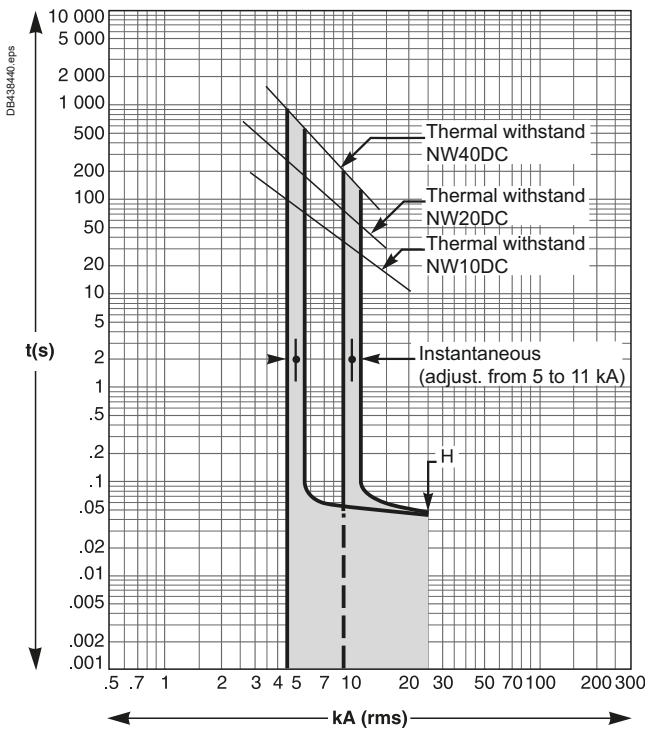







# Catalog Numbers and Order Form

**ComPacT NSX100 DC to NSX630 DC**  
 Choice of Device ..... F-4

**ComPacT NSX100 DC to 1200 DC, NSX400 NA DC to NSX630 NA DC**  
 Choice of Device ..... F-5  
 Connection Accessories ..... F-6  
 Electrical Auxiliaries ..... F-8  
 Operation and Locking/Interlocking ..... F-10  
 Installation ..... F-11

**ComPacT NSX100 DC to NSX630 DC**  
 Plug-in/Withdrawable Accessories ..... F-12

**Spare Parts: ComPacT NSX100 DC to 1200 DC, NSX400 NA DC to NSX630 NA DC** ..... F-13

**ComPacT INS DC PV - ComPacT NSX80/500 TM DC PV to NSX100/500 NA DC PV** ..... F-14  
 Connection Accessories ..... F-15  
 Electrical Auxiliaries ..... F-17  
 Operation and Locking/Interlocking ..... F-19  
 Installation ..... F-20

**ComPacT NSX630b to 1600 NA DC PV Fixed Electrically Operated** ..... F-21  
 Complete Device without Motor Mechanism Module ..... F-21  
 Device Based on Separate Components with or without Motor Mechanism Module ..... F-22

**ComPacT INS40 to 160 DC**  
 Complete Fixed/FC Device and Accessories ..... F-23  
 Accessories ..... F-24

**ComPacT INS250-100 to 630 DC**  
 Complete Fixed/FC Device and Accessories ..... F-26

**ComPacT INV100 to 630 DC**  
 Complete Fixed/FC Device and Specific Accessories ..... F-27

**Other Chapters**

Presentation ..... 2  
 Functions and Characteristics ..... A-1  
 Installation Recommendations ..... B-1  
 Dimensions and Connection ..... C-1  
 Electrical Diagrams ..... D-1  
 Additional Characteristics ..... E-1

## Catalog Numbers and Order Form

<b>ComPacT INS250-100 to 250 DC and ComPacT INV100 to 250 DC</b> Accessories .....	F-28
<b>ComPacT INS320 to 630 DC and ComPacT INV320 to 630 DC</b> Accessories .....	F-31
<b>ComPacT INS630b to 2500 DC</b> Complete Fixed/FC Device and Accessories .....	F-33
Complete Fixed/FC Device and Specific Accessories .....	F-34
<b>ComPacT INS630b to 2500 DC and ComPacT INV630b to 2500 DC</b> Accessories .....	F-35
<b>NW10 DC to NW40 DC Fixed and Drawout Circuit Breakers and Switch-Disconnectors .....</b>	<b>F-37</b>
<b>NW10 DC to NW40 DC Fixed Circuit Breakers</b> Indication Contacts .....	F-38
Remote Operation.....	F-39
<b>NW10 DC to NW40 DC Drawout Circuit Breakers</b> Indication Contacts .....	F-40
Chassis Locking and Accessories .....	F-41
Remote Operation.....	F-42
<b>Accessories for NW10 DC to NW40 DC Fixed and Drawout Circuit Breakers .....</b>	<b>F-43</b>

F

### Other Chapters

Presentation .....	2
Functions and Characteristics .....	A-1
Installation Recommendations.....	B-1
Dimensions and Connection .....	C-1
Electrical Diagrams.....	D-1
Additional Characteristics.....	E-1

# Catalog Numbers and Order Form

**Spare Parts: MasterPact NW DC, EPDC, DC PV**

Connection ..... F-44

Remote Operation ..... F-45

Chassis Locking and Accessories ..... F-46

Clusters ..... F-47

Circuit Breaker Locking and Accessories

Mechanical Interlocking for Source Changeover ..... F-48

Indication Contacts ..... F-49

Instructions ..... F-50

**Spare Parts: MasterPact NW DC, EPDC, DC PV**

Monitoring and Control Converter ..... F-51

**ComPacT NSX100 DC to NSX250 DC**

Circuit Breakers ..... F-52

**ComPacT NSX400 DC to NSX630 DC**

Circuit Breakers and Switch-Disconnectors ..... F-53

**ComPacT NSX1200 DC Circuit Breakers** ..... F-54

**ComPacT NSX80/500 TM DC PV**  
to **NSX100/500 NA DC PV**

Circuit Breakers and Switch-Disconnectors ..... F-55

**ComPacT NSX250/500 TM DC EP**  
to **NSX250/630 NA DC EP**

Circuit Breakers and Switch-Disconnectors ..... F-56

**ComPacT NSX630/1600 NA DC PV 4P,**  
**Fixed Version**

Upside: Front Connection, 2 Kit Heatsink, Phase Separator  
Are Included ..... F-57

**MasterPact NW DC** ..... F-58



**Other Chapters**

Presentation ..... 2

Functions and Characteristics ..... A-1

Installation Recommendations ..... B-1

Dimensions and Connection ..... C-1

Electrical Diagrams ..... D-1

Additional Characteristics ..... E-1

# ComPacT NSX100 DC to NSX630 DC

## Choice of Device

### ComPacT NSX100/160 F/N/M/S 1P/2P

With thermal-magnetic trip unit TM-D

DB438124.ai

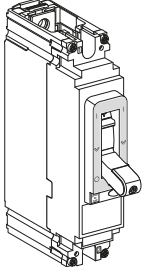

**ComPacT NSX100F AC/DC**

Rating	1P 1d (Icu = 36 kA 250 V DC)	2P 2d (Icu = 36 kA 250 V DC/1P - 500 V DC/2P)
TM16D	C10F1TM016	C10F2TM016
TM20D	C10F1TM020	C10F2TM020
TM25D	C10F1TM025	C10F2TM025
TM30D	C10F1TM030	C10F2TM030
TM40D	C10F1TM040	C10F2TM040
TM50D	C10F1TM050	C10F2TM050
TM63D	C10F1TM063	C10F2TM063
TM80D	C10F1TM080	C10F2TM080
TM100D	C10F1TM100	C10F2TM100

**ComPacT NSX160F AC/DC**

Rating	1P 1d (Icu = 36 kA 250 V DC)	2P 2d (Icu = 36 kA 250 V DC/1P - 500 V DC/2P)
TM125D	C16F1TM125	C16F2TM125
TM160D	C16F1TM160	C16F2TM160

**ComPacT NSX100N AC/DC**

Rating	1P 1d (Icu = 50 kA 250 V DC)	2P 2d (Icu = 85 kA 250 V DC/1P - 500 V DC/2P)
TM16D	C10N1TM016	C10M2TM016
TM20D	C10N1TM020	C10M2TM020
TM25D	C10N1TM025	C10M2TM025
TM30D	C10N1TM030	C10M2TM030
TM40D	C10N1TM040	C10M2TM040
TM50D	C10N1TM050	C10M2TM050
TM63D	C10N1TM063	C10M2TM063
TM80D	C10N1TM080	C10M2TM080
TM100D	C10N1TM100	C10M2TM100

**ComPacT NSX160N AC/DC**

Rating	1P 1d (Icu = 50 kA 250 V DC)	2P 2d (Icu = 85 kA 250 V DC/1P - 500 V DC/2P)
TM125D	C16N1TM125	C16M1TM125
TM160D	C16N1TM160	C16M1TM160

**ComPacT NSX100M AC/DC**

Rating	1P 1d (Icu = 85 kA 250 V DC)	2P 2d (Icu = 100 kA 250 V DC/1P - 500 V DC/2P)
TM16D	C10M1TM016	C10S2TM016
TM20D	C10M1TM020	C10S2TM020
TM25D	C10M1TM025	C10S2TM025
TM30D	C10M1TM030	C10S2TM030
TM40D	C10M1TM040	C10S2TM040
TM50D	C10M1TM050	C10S2TM050
TM63D	C10M1TM063	C10S2TM063
TM80D	C10M1TM080	C10S2TM080
TM100D	C10M1TM100	C10S2TM100

**ComPacT NSX160M AC/DC**

Rating	1P 1d (Icu = 85 kA 250 V DC)	2P 2d (Icu = 100 kA 250 V DC/1P - 500 V DC/2P)
TM125D	C16M1TM125	C16S2TM125
TM160D	C16M1TM160	C16S2TM160

DB438125.ai

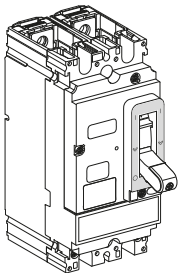

F

# ComPacT NSX100 DC to 1200 DC, NSX400 NA DC to NSX630 NA DC

## Choice of Device

### ComPacT NSX100/160/250 DC

#### Basic frame

DB438126.ai

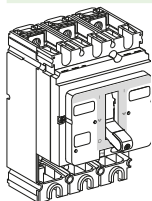

Rating	3P	4P
NSX100F DC	(Icu = 36 kA 250 V DC/1P - 500 V DC/ 2P - 750 V DC/3P) C10F3D	C10F4D
NSX160F DC	C16F3D	C16F4D
NSX250F DC	C25F3D	C25F4D
	(Icu = 100 kA 250 V DC/1P - 500 V DC/ 2P - 750 V DC/3P)	
NSX100S DC	C10S3D	C10S4D
NSX160S DC	C16S3D	C16S4D
NSX250S DC	C25S3D	C25S4D

#### + Trip unit

DB 112246.epa

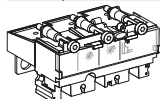

#### Standard protection: trip unit TM-D/DC

Rating	3P 3d	4P 4d
TM16D	C103TM016	C104TM016
TM25D	C103TM025	C104TM025
TM32D	C103TM032	C104TM032
TM40D	C103TM040	C104TM040
TM50D	C103TM050	C104TM050
TM63D	C103TM063	C104TM063
TM80DC	C103TM080D	C104TM080D
TM100DC	C103TM100D	C104TM100D
TM125DC	C163TM125D	C164TM125D
TM160DC	C163TM160D	C164TM160D
TM200DC	C253TM200D	C254TM200D
TM250DC	C253TM250D	C254TM250D

#### Type G protection: trip unit TM-G

Rating	3P 3d	4P 4d
TM16G	C103MG016	C104MG016
TM25G	C103MG025	C104MG025
TM40G	C103MG040	C104MG040
TM63G	C103MG063	C104MG063
TM80G	C103MG080	C104MG080
TM100G	C103MG100	C104MG100
TM125G [*]	C163MG125D	C164MG125D
TM160G [*]	C163MG160D	C164MG160D
TM200G [*]	C253MG200D	C254MG200D
TM250G [*]	C253MG250D	C254MG250D

### ComPacT NSX250/630 F/S DC

DB438127.ai

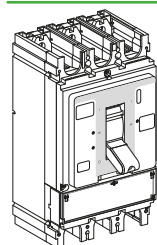

Rating	3P	4P
NSX250F TM-DC	(Icu = 36 kA 250 V DC/1P - 500 V DC/ 2P - 750 V DC/3P) C40F3TM250D	C40F4TM250D
NSX320F TM-DC	C40F3TM320D	C40F4TM320D
NSX400F TM-DC	C40F3TM400D	C40F4TM400D
NSX500F TM-DC	C63F3TM500D	C63F4TM500D
	(Icu = 36 kA 250 V DC/1P - 500 V DC/ 2P)	
NSX600F TM-DC	C63F3TM600D	C63F4TM600D
	(Icu = 100 kA 250 V DC/1P - 500 V DC/ 2P - 750 V DC/3P)	
NSX250S TM-DC	C40S3TM250D	C40S4TM250D
NSX320S TM-DC	C40S3TM320D	C40S4TM320D
NSX400S TM-DC	C40S3TM400D	C40S4TM400D
NSX500S TM-DC	C63S3TM500D	C63S4TM500D
	(Icu = 100 kA 250 V DC/1P - 500 V DC/ 2P)	
NSX600S TM-DC	C63S3TM600D	C63S4TM600D

### ComPacT NSX630/1200 DC

Rating	2P (Icu = 50 kA 300 V DC/ 1P - 600 V DC/2P) without bare cable connector
NSX630 TM-DC	C1BN2TM630D
NSX800 TM-DC	C1BN2TM800D
NSX1000 TM-DC	C1BN2TM10HD
NSX1200 TM-DC	C1BN2TM12HD

### ComPacT NSX100/160/250 NA [1]

#### With NA switch-disconnector unit

DB438128.ai

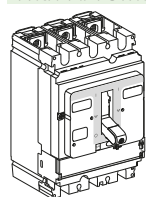

ComPacT NSX100NA		3P	4P
Rating	2P		
100	C102100S	C103100S	C104100S
ComPacT NSX160NA		3P	4P
Rating	2P		
160	C162160S	C163160S	C164160S
ComPacT NSX250NA		3P	4P
Rating	2P		
250	C252250S	C253250S	C254250S

### ComPacT NSX400/630 NA DC

	3P	4P
ComPacT NSX400 NA DC	C403400DS	C404400DS
ComPacT NSX630 NA DC	C633630DS	C634630DS

[1] See catalog ComPacT NSX LVPED221001EN for order form and configured product.

[\*] Adapted products (basic frame and trip unit TMG are not sold separately).







# ComPacT NSX100 DC to 1200 DC, NSX400 NA DC to NSX630 NA DC

## Connection Accessories

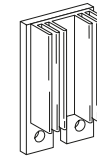
### Special Connection Accessories for Parallel or Series Connection

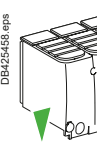
			NSX100-250 DC	NSX400-630 DC	NSX1200 DC
	Connection accessories				
	Connection accessories for parallel or series connection of 2 poles <sup>[1]</sup>	1 connection plate equipped with heat sink + 1 interphase barrier <sup>[2]</sup>	LV438328	LV438338	
	Connection plates				
	Connection plates for parallel connection of 3 poles	1 set of 2 connection plates	LV438329 <sup>[3]</sup>	<sup>[3]</sup>	
	Connection plates for parallel connection of 4 poles			<sup>[3]</sup>	
	1P short terminal shields	1 pair	LV438320		
	2P short terminal shields	2 pairs	2 x LV438320		
	3P terminal shields for series connection of poles	1 set	LV438325	LV438291 <sup>[5]</sup> LV438292 <sup>[5]</sup>	
	4P terminal shields for series connection of poles	1 set	LV438326	LV438294 <sup>[5]</sup> LV438295 <sup>[5]</sup>	
	4P terminal shields for parallel connection of poles (2P/4P)	1 set	LV438327	LV438293 <sup>[5]</sup>	LV438293 <sup>[5]</sup>
	1 long terminal shield for breaker or plug-in base	3P	LV429517		
		4P	LV429518		

### Connection Accessories (Cu or Al)









#### NSX100-250 DC

#### NSX400-630 DC

#### Rear connections

	2 short		LV429235	LV432475
	2 long		LV429236	LV432476

#### Bare cable connectors

	Steel connectors	1.5 to 95 mm <sup>2</sup> ; ≤ 160 A	Set of 2	LV429246	
			Set of 3	LV429242	
			Set of 4	LV429243	
	Aluminium connectors	25 to 95 mm <sup>2</sup> ; ≤ 250 A	Set of 2	LV429255	
			Set of 3	LV429227	
		120 to 185 mm <sup>2</sup> ; ≤ 250 A	Set of 4	LV429228	
			Set of 2	LV429247	
	Clips for connectors		Set of 3	LV429259	
			Set of 4	LV429260	
	Aluminium connectors for 2 cables <sup>[4]</sup> 2 x (50 to 120 mm <sup>2</sup> ) ; ≤ 250 A		Set of 10	LV429241	
			Set of 3 (3P)	LV429218	
	Aluminium connectors for 2 cables <sup>[4]</sup> 2 x (50 to 120 mm <sup>2</sup> ) ; ≤ 250 A		Set of 4 (4P)	LV429219	
		Aluminium connectors 1x (35 to 300 mm <sup>2</sup> )		Set of 3 (3P)	
	Aluminium connectors 1x (35 to 300 mm <sup>2</sup> )		Set of 4 (4P)		LV432480
		Aluminium connectors <sup>[4]</sup> for 6 cables 6 x (1.5 to 35 mm <sup>2</sup> ) ; ≤ 250 A		Set of 3 (3P)	LV429248
	Aluminium connectors <sup>[4]</sup> for 6 cables 6 x (1.5 to 35 mm <sup>2</sup> ) ; ≤ 250 A		Set of 4 (4P)	LV429249	
		Aluminium connectors for 2 cables 2 x (35 to 300 mm <sup>2</sup> )		Set of 3 (3P)	
	Aluminium connectors for 2 cables 2 x (35 to 300 mm <sup>2</sup> )		Set of 4 (4P)		LV432482
		6.35 mm voltage tap for steel or aluminium connectors		Set of 10	LV429348

[1] Series connection: 2 poles = 1 connection plate.  
3 poles = 2 connection plates.  
4 poles = 3 connection plates.  
Parallel connection: 2 poles = 2 connection plates.  
3 poles = 1 set of 2 connection plates (29499).  
2 x 2 poles = 4 connection plates.

[2] These connection accessories come with an interphase barrier.



[3] To be made by the customer.

[4] Supplied with 2 or 3 interphase barriers.

[5] Refer to page B-5 for details.

# ComPacT NSX100 DC to 1200 DC, NSX400 NA DC to NSX630 NA DC

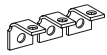
## Connection Accessories (Cont.)

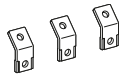
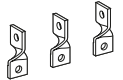
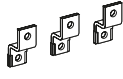
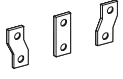
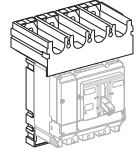
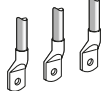
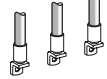
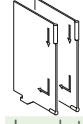
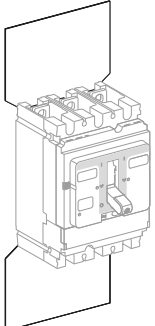
Connection Accessories (Cu or Al)			NSX100-250 DC	NSX400-630 DC	NSX1200 DC
<b>Terminal extensions</b>					
 DB43204.eps	Right-angle terminal extensions	Set of 3	LV429261	LV432484	
		Set of 4	LV429262	LV432485	
 DB43205.eps	Straight terminal extensions	Set of 3	LV429263		
		Set of 4	LV429264		
 DB112230.eps	45° terminal extension <sup>[1]</sup>	Set of 3	LV429223		
		Set of 4	LV429224		
 DB112231.eps	Edgewise terminal extensions <sup>[1]</sup>	Set of 3	LV429308	LV432486	
		Set of 4	LV429309	LV432487	
 DB112234.eps	Double-L terminal extensions <sup>[1]</sup>	Set of 3	LV429221		
		Set of 4	LV429222		
 DB112235.eps	Spreaders from 35 to 45 mm pitch <sup>[1]</sup>	3P	LV431563		
		4P	LV431564		
 DB438128.ai	One-piece spreader from 35 to 45 mm pitch	3P	LV431060		
		4P	LV431061		
		3P/4P	LV431064		
<b>Crimp lugs for copper cable (supplied with 2 or 3 interphase barriers)</b>					
 DB112237.eps	For cable 120 mm <sup>2</sup>	Set of 3	LV429252		
		Set of 4	LV429256		
	For cable 150 mm <sup>2</sup>	Set of 3	LV429253		
		Set of 4	LV429257		
	For cable 185 mm <sup>2</sup>	Set of 3	LV429254	LV429254	LV429254
		Set of 4	LV429258	LV429258	LV429258
For cable 240 mm <sup>2</sup>	Set of 3		LV432500	LV432500	
	Set of 4		LV432501	LV432501	
For cable 300 mm <sup>2</sup>	Set of 3		LV432502	LV432502	
	Set of 4		LV432503	LV432503	
<b>Crimp lugs for aluminium cable (supplied with 2 or 3 interphase barriers)</b>					
 DB112238.eps	For cable 150 mm <sup>2</sup>	Set of 3	LV429504		
		Set of 4	LV429505		
	For cable 185 mm <sup>2</sup>	Set of 3	LV429506	LV429506	LV429506
		Set of 4	LV429507	LV429507	LV429507
	For cable 240 mm <sup>2</sup>	Set of 3		LV432504	LV432504
		Set of 4		LV432505	LV432505
For cable 300 mm <sup>2</sup>	Set of 3		LV432506	LV432506	
	Set of 4		LV432507	LV432507	
<b>Barriers</b>					
 DB43206.eps	Interphase barriers	Set of 6	LV429329	LV432570	
<b>Insulation screen</b>					
 DB438130.ai	2 insulating screens for breaker (45 mm pitch)	3P	LV429330		
		4P	LV429331		
	2 insulating screens for breaker (70 mm pitch)	3P		LV432578	
		4P		LV432579	

[1] Supplied with 2 or 3 interphase barriers.

# ComPacT NSX100 DC to 1200 DC, NSX400 NA DC to NSX630 NA DC Electrical Auxiliaries

## Electrical Auxiliaries

### Auxiliary contacts (changeover)

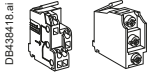

OF or SD or SDE or SDV		<b>29450</b>
OF or SD or SDE or SDV low level		<b>29452</b>
SDE adapter, mandatory for trip unit		<b>LV429451</b>

### Voltage releases

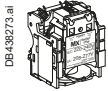

		MX	MN
AC	24 V 50/60 Hz	<b>LV429384</b>	<b>LV429404</b>
	48 V 50/60 Hz	<b>LV429385</b>	<b>LV429405</b>
	110-130 V 50/60 Hz	<b>LV429386</b>	<b>LV429406</b>
	220-240 V 50/60 Hz 208-277 V 60 Hz	<b>LV429387</b>	<b>LV429407</b>
	380-415 V 50 Hz 440-480 V 60 Hz	<b>LV429388</b>	<b>LV429408</b>
	525 V 50 Hz - 600 V 60 Hz	<b>LV429389</b>	<b>LV429409</b>
DC	12 V	<b>LV429382</b>	<b>LV429402</b>
	24 V	<b>LV429390</b>	<b>LV429410</b>
	30 V	<b>LV429391</b>	<b>LV429411</b>
	48 V	<b>LV429392</b>	<b>LV429412</b>
	60 V	<b>LV429383</b>	<b>LV429403</b>
	125 V	<b>LV429393</b>	<b>LV429413</b>
	250 V	<b>LV429394</b>	<b>LV429414</b>

### MN 48 V 50/60 Hz with fixed time delay

Composed of:	MN 48 V DC	<b>LV429412</b>
	Delay unit 48 V 50/60 Hz	<b>LV429426</b>

### MN 220-240 V 50/60 Hz with fixed time delay

Composed of:	MN 250 V DC	<b>LV429414</b>
	Delay unit of 220-240 V 50/60 Hz	<b>LV429427</b>

### MN 48 V DC/AC 50/60 Hz with adjustable time delay

Composed of:	MN 48 V DC	<b>LV429412</b>
	Delay unit 48 V DC/AC 50/60 Hz	<b>33680</b>

### MN110-130 V DC/AC 50/60 Hz with adjustable time delay

Composed of:	MN 125 V DC	<b>LV429413</b>
	Delay unit 100-130 V DC/AC 50/60 Hz	<b>33681</b>

### MN 220-250 V DC/AC 50/60 Hz with adjustable time delay

Composed of:	MN 250 V DC	<b>LV429414</b>
	Delay unit 200-250 V DC/AC 50/60 Hz	<b>33682</b>

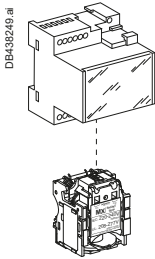

## Motor Mechanism

### Motor mechanism module supplied with SDE adapter

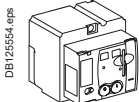

	Voltage	MT100/160	MT250	MT400-630
AC	48-60 V 50/60 Hz	<b>LV429440</b>	<b>LV431548</b>	<b>LV432639</b>
	110-130 V 50/60 Hz	<b>LV429433</b>	<b>LV431540</b>	<b>LV432640</b>
	220-240 V 50/60 Hz 208-277 V 60 Hz	<b>LV429434</b>	<b>LV431541</b>	<b>LV432641</b>
	380-415 V 50/60 Hz 440-480 V 60 Hz	<b>LV429435</b>	<b>LV431542</b>	<b>LV432642 LV432647</b>
	24-30 V	<b>LV429436</b>	<b>LV431543</b>	<b>LV432643</b>
DC	48-60 V	<b>LV429437</b>	<b>LV431544</b>	<b>LV432644</b>
	110-130 V	<b>LV429438</b>	<b>LV431545</b>	<b>LV432645</b>
	250 V	<b>LV429439</b>	<b>LV431546</b>	<b>LV432646</b>
Operations counter			<b>LV432648</b>	



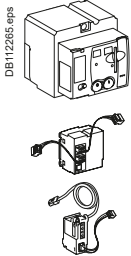



### Communicating motor mechanism module supplied with SDE adapter

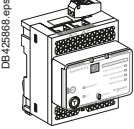
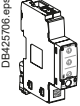
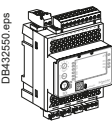
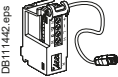

Motor mechanism module	MTc 100/160	220-240 V 50/60 Hz	<b>LV429441</b>
	MTc 250	220-240 V 50/60 Hz	<b>LV431549</b>
	MTc 400/630	220-240 V 50/60 Hz	<b>LV432652</b>
+ Breaker and Status Communication Module	BSCM		<b>LV434205</b>
+ NSX cord	Wire length L = 0.35 m		<b>LV434200</b>
	Wire length L = 1.3 m		<b>LV434201</b>
	Wire length L = 3 m		<b>LV434202</b>
	U > 480 V AC wire length L = 0.35 m		<b>LV434204</b>

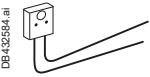
# ComPacT NSX100 DC to 1200 DC, NSX400 NA DC to NSX630 NA DC Electrical Auxiliaries

## Communication Option

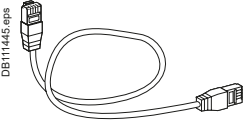
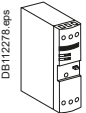
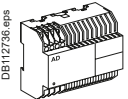
 DB42568.eps	IFE	Ethernet interface for LV breaker	LV434001
		Ethernet interface for LV breakers and gateway	LV434002
 DB425706.eps	IFM Modbus-SL interface module		LV434000
 DB425250.eps	I/O application module		LV434063
	User guide IFE		DOCA0084EN
	User guide I/O application module		DOCA0055EN
<b>ULP wiring accessories</b>			
 DB111442.eps	NSX cord L = 0.35 m		LV434200
	NSX cord L = 1.3 m		LV434201
	NSX cord L = 3 m		LV434202
	NSX cord for U > 480 V AC L = 1.3 m		LV434204
 DB115621.eps	10 stacking connectors for communication interface modules		TRV00217
 DB43564.ai	2 Modbus line terminators		VW3A8306DRC <sup>[1]</sup>
 DB115622.eps	RS 485 roll cable (4 wires, length 60 m)		50965
 DB115623.eps	5 RJ45 connectors female/female		TRV00870
 DB111444.eps	10 ULP line terminators		TRV00880
 DB111445.eps	10 RJ45/RJ45 male cord L = 0.3 m		TRV00803
	10 RJ45/RJ45 male cord L = 0.6 m		TRV00806
	5 RJ45/RJ45 male cord L = 1 m		TRV00810
	5 RJ45/RJ45 male cord L = 2 m		TRV00820
	5 RJ45/RJ45 male cord L = 3 m		TRV00830
	1 RJ45/RJ45 male cord L = 5 m		TRV00850
<b>Power supply modules</b>			
 DB112276.eps	External power supply module 100-240 V AC 110-230 V DC/24 V DC-3 A class 2		ABL8RPS24030 <sup>[2]</sup>
 DB112736.eps	External power supply module 24 V DC-1 A OVC IV		
	24-30 V DC		54440
	48-60 V DC		54441
	100-125 V AC		54442
	110-130 V AC		54443
	200-240 V AC		54444
380-415 V AC		54445	

[1] SDE adapter mandatory for trip unit TM, TMG.

[2] www.schneider-electric.com.

# ComPacT NSX100 DC to 1200 DC, NSX400 NA DC to NSX630 NA DC

## Operation and Locking/Interlocking

### Rotary Handles

#### Direct rotary handles

	With black handle		LV429337T	LV432597T
	With red handle on yellow front		LV429339T	LV432599T
	MCC conversion accessory		LV429341T	LV432606T
	CNOMO conversion accessory		LV429342T	LV432602T

#### Extended rotary handle

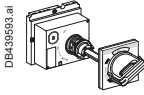
	With black handle		LV429338T	LV432598T
	With red handle on yellow front		LV429340T	LV432600T
	With telescopic handle for withdrawable device		LV429343T	LV432603T

#### Accessories

Indication auxiliary	1 early-break contact	LV429345	LV432605
	2 early-break contacts	LV429346	LV429346

### Locks

#### Toggle locking device for 1 to 3 padlocks

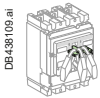
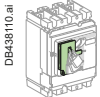
	By removable device		29370	29370
	By fixed device for 3P/4P (open or close position)		LV429371	LV432631
	By fixed device for 3P/4P (open position only)		LV429370	LV432630

#### Locking of the rotary handle

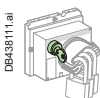
	Keylock adapter (keylock not included)		LV429344	LV432604
	Keylock (keylock adapter not included)	Ronis 1351B.500	41940	41940
		Profalux KS5 B24 D4Z	42888	42888

#### Locking of the motor mechanism modules

	Keylock adapter + Ronis keylock (special)		LV429449	LV432649
	Keylock (keylock adapter not included)	Ronis 1351B.500		41940
		Profalux KS5 B24 D4Z		42888

### Interlocking

#### Mechanical interlocking for circuit breakers

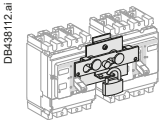
	With toggles		LV429354T	LV432614T
	With rotary handles		LV429369T	LV432621T

#### Interlocking with key (2 keylocks/1 key) for rotary handles

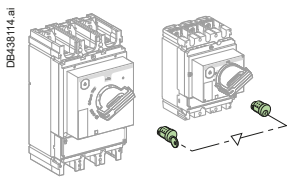
	Keylock kit (keylock not included) <sup>[1]</sup>		LV429344	LV432604
	1 set of 2 keylocks	Ronis 1351B.500	41950	41950
	(1 key only, keylock kit not included)	Profalux KS5 B24 D4Z	42878	42878

[1] NSX100-250 DC only.

# ComPacT NSX100 DC to 1200 DC, NSX400 NA DC to NSX630 NA DC Installation

## Installation Accessories

NSX100-250 DC | NSX400-1200 DC

### Front-panel escutcheons

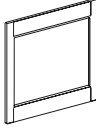
DB112269.eps 	IP30 escutcheon for all control types	LV429525	LV432557
	IP30 trip unit access escutcheon for toggle	LV429526	LV432559

IP30

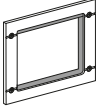
DB112737.eps 	IP40 escutcheon for all control types	LV429317	LV432558
---	---------------------------------------	----------	----------

IP40

### IP43 rubber toggle cover

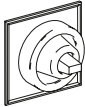
DB112738.eps 	1 toggle cover	LV429319	LV432560
---	----------------	----------	----------

### Lead-sealing accessories

DB115615.eps 	Bag of accessories	LV429375	LV429375
--	--------------------	----------	----------

### Din rail adapter

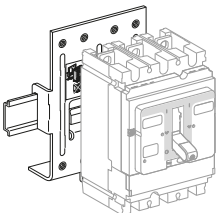
DB638115.ai 	1 adapter	LV429305	
--	-----------	----------	--





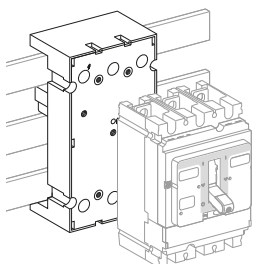

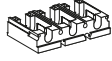

### 60 Mm Plate Busbar Adapter

NSX100-250 DC | NSX400-630 DC

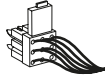
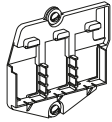
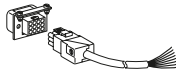
DB638116.ai 	3P 60 mm busbar adapter	LV429372	LV432623
	4P 60 mm busbar adapter	LV429373	LV432624

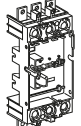
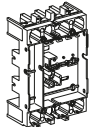

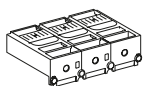
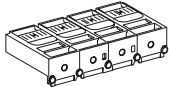
# ComPacT NSX100 DC to NSX630 DC Plug-in/Withdrawable Accessories

Plug-in/Withdrawable Version Accessories		NSX100-250 DC	NSX400-630 DC	
<b>Insulation accessories</b>				
	1 connection adapter for plug-in base	3P	LV429306	LV432584
		4P	LV429307	LV432585
<b>Auxiliary connections</b>				
	1 9-wire fixed connector (for base)		LV429273	LV429273
	1 9-wire moving connector (for circuit breaker)		LV429274	LV432523
	1 support for 2 moving connectors		LV429275	LV432525
	9-wire manual auxiliary connector (fixed + moving)		LV429272	LV429272
<b>Plug-in base accessories</b>				
	2 long insulated right angle terminal extensions	Set of 2	LV429276	LV432526
	2 IP40 shutters for base		LV429271	LV432521
	Base	2P	LV429265	
		3P	LV429266	LV432516
	Base	4P	LV429267	LV432517
	2 power connections	2/3/4P	LV429268	LV432518
	1 short terminal shields	2/3P	LV429515	LV432591
	1 short terminal shields	4P	LV429516	LV432592
	1 safety trip interlock	2/3/4P	LV429270	LV432520
<b>Installation and connection</b>				
	Kit for ComPacT	3P	LV429289 + LV429282 + LV429283	LV432538 + LV432532 + LV432533
		4P	LV429290 + LV429282 + LV429283	LV432539 + LV432532 + LV432533

F



# Spare Parts: ComPacT NSX100 DC to 1200 DC, NSX400 NA DC to NSX630 NA DC

Spare Parts		NSX100-250 DC	NSX400-1200 DC
	Additional toggle extension		<b>32595</b>
	10 spare toggle extensions (only for ComPacT NSX250) 5 spare toggle extensions	<b>LV429313</b>	<b>LV432553</b>
	Bag of screws	<b>LV429312</b>	<b>LV432552</b>
	12 snap-in nuts (fixed/FC)	M6 for NSX100N/H/L M8 for NSX160/250N/H/L	<b>LV429234</b> <b>LV430554</b>
	NS retrofit escutcheon	Small cut-out	<b>LV429528</b> <b>LV432571</b>
	IP40 toggle escutcheon	ComPacT NS type/small cut-out	<b>29315</b> <b>32556</b>
	1 set of 10 identification labels		<b>LV429226</b> <b>LV429226</b>
	1 base for extended rotary handle		<b>LV429502</b> <b>LV432498</b>
	Torque limiting screws (set of 12)	3P/4P ComPacT NSX100-630	<b>LV429513</b> <b>LV432513</b>
	5 transparent covers for trip unit	TM, MA, NA	<b>LV429481</b>



# ComPacT INS DC PV - ComPacT NSX80/500 TM DC PV to NSX100/500 NA DC PV

## ComPacT INS DC PV - 1 [1]

	ComPacT INS PV - 1	4P	28907

## ComPacT NSX TM DC PV 4P Circuit Breaker

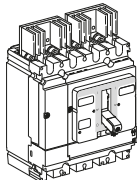
	Connection and Insulation Accessories Mandatory					
		Upstream connection (x2)	Upstream terminal shields	Downstream terminal shields		
	NSX80	C10F4TM080D1	connection plate with heatsink	LV438328	LV438327	LV429518
	NSX125	C16F4TM125D1		LV438328	LV438327	LV429518
	NSX160	C16F4TM160D1		LV438328	LV438327	LV429518
	NSX200	C25F4TM200D1		LV438328	LV438327	LV429518
	NSX250	C40F4TM250D1		LV438338	LV438293	LV432594
	NSX320	C40F4TM320D1		LV438338	LV438293	LV432594
	NSX400	C40F4TM400D1		LV438338	LV438293	LV432594
NSX500	C63F4TM500D1		LV438338	LV438293	LV432594	

## ComPacT NSX NA DC PV 4P Switch Disconnector

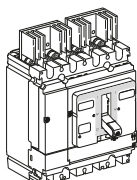
	Connection and Insulation Accessories Mandatory							
		Upstream connection (x2)	Upstream terminal shields	or interphase barrier	Downstream terminal shields	or interphase barrier		
	NSX100	C104100D1S	connection plate with heatsink	LV438328	LV438327	LV429329	LV429518	LV429329
	NSX160	C164160D1S		LV438328	LV438327	LV429329	LV429518	LV429329
	NSX200 (≤ 200 A at 40 °C)	C254200D1S		LV438328	LV438327	LV429329	LV429518	LV429329
	NSX200 (= 200 A at 55 °C)	C254200D1S	connection plate with heatsink (long)	LV438339	not available	LV429329	LV429518	LV429329
	NSX400	C404400D1S	connection plate with heatsink	LV438338	LV438337	LV432570	LV432594	LV432570
	NSX500	C634500D1S		LV438338	LV438337	LV432570	LV432594	LV432570

## ComPacT NSX TM DC EP 4P Circuit Breaker

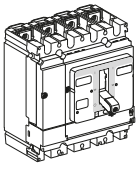
	Connection and Insulation Accessories Mandatory					
		Upstream connection (x2)	Upstream terminal shields	Downstream terminal shields		
	NSX250-100	C25F4TM100D3 [2]	connection plate with heatsink	LV438328	LV438327	LV429518
	NSX250-125	C25F4TM125D3 [2]		LV438328	LV438327	LV429518
	NSX250-160	C25F4TM160D3 [2]		LV438328	LV438327	LV429518
	NSX250-200	C25F4TM200D3 [2]		LV438328	LV438327	LV429518
	NSX250-250	C25F4TM250D3 [2]		LV438328	LV438327	LV429518
	NSX500-250	C50F4TM250D3 [2]		LV438338	LV438293	LV432594
	NSX500-320	C50F4TM320D3 [2]		LV438338	LV438293	LV432594
	NSX500-400	C50F4TM400D3 [2]		LV438338	LV438293	LV432594
NSX500-500	C50F4TM500D3 [2]		LV438338	LV438293	LV432594	



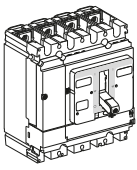

## ComPacT NSX NA DC EP 4P Switch Disconnector

	Connection and Insulation Accessories Mandatory							
		Upstream connection (x2)	Upstream terminal shields	or interphase barrier	Downstream terminal shields	or interphase barrier		
	NSX250-100	C254100D3S [2]	connection plate with heatsink	LV438328	LV438327	LV429329	LV429518	LV429329
	NSX250-160	C254160D3S [2]		LV438328	LV438327	LV429329	LV429518	LV429329
	NSX250-200	C254200D3S [2]		LV438328	LV438327	LV429329	LV429518	LV429329
	NSX250-250	C254250D3S [2]		LV438328	LV438327	LV429329	LV429518	LV429329
	NSX630-320	C634320D3S [2]		LV438338	LV438293	LV432570	LV432594	LV432570
	NSX630-400	C634400D3S [2]		LV438338	LV438293	LV432570	LV432594	LV432570
	NSX630-500	C634500D3S [2]		LV438338	LV438293	LV432570	LV432594	LV432570
	NSX630-630	C634630D3S [2]		LV438338	LV438293	LV432570	LV432594	LV432570

[1] For accessories, see catalog INS/INV page dedicated to INS40 to 160 A.  
 [2] Please consult Schneider Electric for information on the availability of the product.

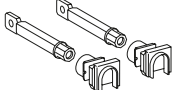
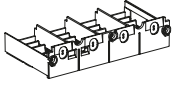
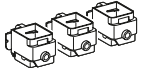
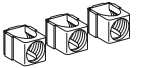
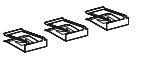
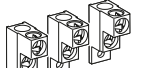
F

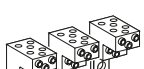
# ComPacT NSX80/500 TM DC PV to NSX100/500 NA DC PV Connection Accessories





Connection Accessories (Cu or Al)			NSX100-250 DC PV	NSX400-630 DC PV
<b>Rear connections</b>				
DB112225.eps 	2 short		LV429235	LV432475
	2 long		LV429236	LV432476
<b>Terminal shield</b>				
DB432107.eps 	1 short terminal shield for breaker or plug-in base	4P	LV429516	LV432592
<b>Bare cable connectors</b>				
DB112226.eps 	Steel connectors	1.5 to 95 mm <sup>2</sup> ; ≤ 160 A	Set of 2	LV429246
			Set of 3	LV429242
			Set of 4	LV429243
DB112725.eps 	Aluminium connectors	25 to 95 mm <sup>2</sup> ; ≤ 250 A	Set of 2	LV429255
			Set of 3	LV429227
			Set of 4	LV429228
			Set of 2	LV429247
DB112726.eps 	Clips for connectors	120 to 185 mm <sup>2</sup> ; ≤ 250 A	Set of 3	LV429259
			Set of 4	LV429260
			Set of 10	LV429241
DB112227.eps 	Aluminium connectors for 2 cables <sup>[1]</sup> 2 x (50 to 120 mm <sup>2</sup> ) ; ≤ 250 A		Set of 3 (3P)	LV429218
			Set of 4 (4P)	LV429219
DB112228.eps 	Aluminium connectors 1 x (35 to 300 mm <sup>2</sup> )		Set of 3 (3P)	LV432479
			Set of 4 (4P)	LV432480
DB112229.eps 	Aluminium connectors <sup>[1]</sup> for 6 cables 6 x (1.5 to 35 mm <sup>2</sup> ) ; ≤ 250 A		Set of 3 (3P)	LV429248
			Set of 4 (4P)	LV429249
DB112724.eps 	Aluminium connectors for 2 cables 2 x (35 to 300 mm <sup>2</sup> )		Set of 3 (3P)	LV432481
			Set of 4 (4P)	LV432482
DB112724.eps 	6.35 mm voltage tap for steel or aluminium connectors		Set of 10	LV429348

[1] Supplied with 2 or 3 interphase barriers.

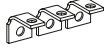

# ComPacT NSX80/500 TM DC PV to NSX100/500 NA DC PV Connection Accessories (Cont.)

## Connection Accessories (Cu or Al)

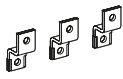
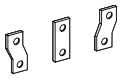
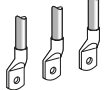
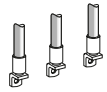
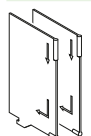
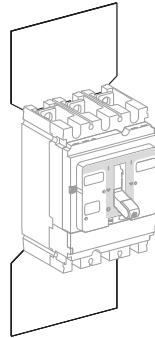
			NSX100-250 DC PV	NSX400-630 DC PV	
<b>Terminal extensions</b>					
	Right-angle terminal extensions	Set of 2	<b>LV429250</b>		
		Set of 3	<b>LV429261</b>	<b>LV432484</b>	
		Set of 4	<b>LV429262</b>	<b>LV432485</b>	
	Straight terminal extensions	Set of 2	<b>LV429251</b>		
		Set of 3	<b>LV429263</b>		
		Set of 4	<b>LV429264</b>		
	45° terminal extension <sup>[1]</sup>	Set of 3	<b>LV429223</b>		
		Set of 4	<b>LV429224</b>		
	Edgewise terminal extensions <sup>[1]</sup>	Set of 3	<b>LV429308</b>	<b>LV432486</b>	
		Set of 4	<b>LV429309</b>	<b>LV432487</b>	
	Double-L terminal extensions <sup>[1]</sup>	Set of 3	<b>LV429221</b>		
		Set of 4	<b>LV429222</b>		
	Spreaders from 35 to 45 mm pitch <sup>[1]</sup>	3P	<b>LV431563</b>		
		4P	<b>LV431564</b>		
<b>Crimp lugs for copper cable (supplied with 2 or 3 interphase barriers)</b>					
	For cable 120 mm <sup>2</sup>	Set of 3	<b>LV429252</b>		
		Set of 4	<b>LV429256</b>		
		For cable 150 mm <sup>2</sup>	Set of 3	<b>LV429253</b>	
			Set of 4	<b>LV429257</b>	
		For cable 185 mm <sup>2</sup>	Set of 3	<b>LV429254</b>	
			Set of 4	<b>LV429258</b>	
For cable 240 mm <sup>2</sup>	Set of 3		<b>LV432500</b>		
	Set of 4		<b>LV432501</b>		
For cable 300 mm <sup>2</sup>	Set of 3		<b>LV432502</b>		
	Set of 4		<b>LV432503</b>		
<b>Crimp lugs for aluminium cable (supplied with 2 or 3 interphase barriers)</b>					
	For cable 150 mm <sup>2</sup>	Set of 3	<b>LV429504</b>		
		Set of 4	<b>LV429505</b>		
	For cable 185 mm <sup>2</sup>	Set of 3	<b>LV429506</b>		
		Set of 4	<b>LV429507</b>		
	For cable 240 mm <sup>2</sup>	Set of 3		<b>LV432504</b>	
Set of 4			<b>LV432505</b>		
For cable 300 mm <sup>2</sup>	Set of 3		<b>LV432506</b>		
	Set of 4		<b>LV432507</b>		
<b>Barriers</b>					
	Interphase barriers	Set of 6	<b>LV429329</b>	<b>LV432570</b>	
<b>Insulation screen</b>					
	2 insulating screens for breaker (45 mm pitch)	3P	<b>LV429330</b>		
		4P	<b>LV429331</b>		
	2 insulating screens for breaker (70 mm pitch)	3P		<b>LV432578</b>	
		4P		<b>LV432579</b>	

[1] Supplied with 2 or 3 interphase barriers.

**Note:** Circuit breakers or switch-disconnectors must be in "off" position when fitting the mechanical or electrical accessories.

# ComPacT NSX80/500 TM DC PV to NSX100/500 NA DC PV Electrical Auxiliaries

## Electrical Auxiliaries

### Auxiliary contacts (changeover)

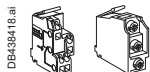

OF or SD or SDE or SDV		29450
OF or SD or SDE or SDV low level		29452
SDE adapter, mandatory for trip unit		LV429451

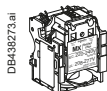

Voltage releases		MX	MN
AC	24 V 50/60 Hz	LV429384	LV429404
	48 V 50/60 Hz	LV429385	LV429405
	110-130 V 50/60 Hz	LV429386	LV429406
	220-240 V 50/60 Hz 208-277 V 60 Hz	LV429387	LV429407
	380-415 V 50 Hz 440-480 V 60 Hz	LV429388	LV429408
	525 V 50 Hz - 600 V 60 Hz	LV429389	LV429409
DC	12 V	LV429382	LV429402
	24 V	LV429390	LV429410
	30 V	LV429391	LV429411
	48 V	LV429392	LV429412
	60 V	LV429383	LV429403
	125 V	LV429393	LV429413
	250 V	LV429394	LV429414

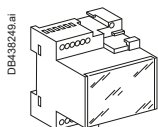

<b>MN 48 V 50/60 Hz with fixed time delay</b>			
Composed of:	MN 48 V DC		LV429412
	Delay unit 48 V 50/60 Hz		LV429426

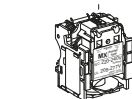

<b>MN 220-240 V 50/60 Hz with fixed time delay</b>			
Composed of:	MN 250 V DC		LV429414
	Delay unit of 220-240 V 50/60 Hz		LV429427

<b>MN 48 V DC/AC 50/60 Hz with adjustable time delay</b>			
Composed of:	MN 48 V DC		LV429412
	Delay unit 48 V DC/AC 50/60 Hz		33680

<b>MN1 10-130 V DC/AC 50/60 Hz with adjustable time delay</b>			
Composed of:	MN 125 V DC		LV429413
	Delay unit 100-130 V DC/AC 50/60 Hz		33681

<b>MN 220-250 V DC/AC 50/60 Hz with adjustable time delay</b>			
Composed of:	MN 250 V DC		LV429414
	Delay unit 200-250 V DC/AC 50/60 Hz		33682

## Motor Mechanism

### Motor mechanism module supplied with SDE adapter

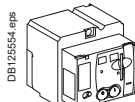

	Voltage	MT100/160/250	MT400-630
AC	48-60 V 50/60 Hz	LV431548	LV432639
	110-130 V 50/60 Hz	LV431540	LV432640
	220-240 V 50/60 Hz	LV431541	LV432641
	208-277 V 60 Hz		
	380-415 V 50/60 Hz	LV431542	LV432642
	440-480 V 60 Hz		LV432647
DC	24-30 V	LV431543	LV432643
	48-60 V	LV431544	LV432644
	110-130 V	LV431545	LV432645
	250 V	LV431546	LV432646
Operations counter			LV432648

### Communicating motor mechanism module supplied with SDE adapter

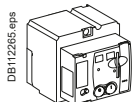

Motor mechanism module	MTc 100/160/250	220-240 V 50/60 Hz	LV431549
	MTc 400/630	220-240 V 50/60 Hz	LV432652
+ Breaker and Status Communication Module	BSCM		LV434205
+ NSX cord	Wire length L = 0.35 m		LV434200
	Wire length L = 1.3 m		LV434201
	Wire length L = 3 m		LV434202
	U > 480 V AC wire length L = 0.35 m		LV434204







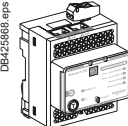
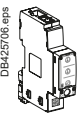
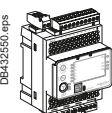

# ComPacT NSX80/500 TM DC PV to NSX100/500 NA DC PV Electrical Auxiliaries

## Communication Option <sup>[1]</sup>

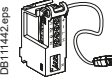
### ULP communication module

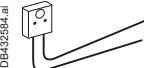
	IFE	Ethernet interface for LV breaker	LV434001
		Ethernet interface for LV breakers and gateway	LV434002
	IFM Modbus-SL interface module		LV434000
	I/O application module		LV434063
	User guide IFE		DOCA0084EN
	User guide I/O application module		DOCA0055EN

### ULP wiring accessories

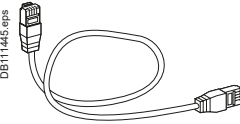

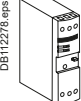
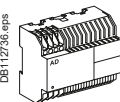

	NSX cord L = 0.35 m		LV434200
	NSX cord L = 1.3 m		LV434201
	NSX cord L = 3 m		LV434202
	NSX cord for U > 480 V AC L = 1.3 m		LV434204
	10 stacking connectors for communication interface modules		TRV00217
	2 Modbus line terminators		VW3A8306DRC <sup>[2]</sup>
	RS 485 roll cable (4 wires, length 60 m)		50965
	5 RJ45 connectors female/female		TRV00870
	10 ULP line terminators		TRV00880
	10 RJ45/RJ45 male cord L = 0.3 m		TRV00803
	10 RJ45/RJ45 male cord L = 0.6 m		TRV00806
	5 RJ45/RJ45 male cord L = 1 m		TRV00810
	5 RJ45/RJ45 male cord L = 2 m		TRV00820
	5 RJ45/RJ45 male cord L = 3 m		TRV00830
	1 RJ45/RJ45 male cord L = 5 m		TRV00850

### Power supply modules

	External power supply module 100-240 V AC 110-230 V DC/24 V DC-3 A class 2		ABL8RPS24030
	External power supply module 24 V DC-1 A OVC IV		
	24-30 V DC		54440
	48-60 V DC		54441
	100-125 V AC		54442
	110-130 V AC		54443
	200-240 V AC		54444
	380-415 V AC		54445

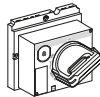
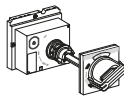
[1] NSX80-250 DC PV TM/NA only.  
[2] www.schneider-electric.com.

# ComPacT NSX80/500 TM DC PV to NSX100/500 NA DC PV Operation and Locking/Interlocking

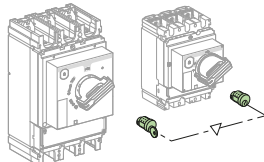
Rotary Handles		NSX100-250 DC PV	NSX400-630 DC PV	
<b>Direct rotary handles</b>				
DB438131.ai 	With black handle	LV429337	LV432597	
	With red handle on yellow front	LV429339	LV432599	
	MCC conversion accessory	LV429341	LV432606	
	CNOMO conversion accessory	LV429342	LV432602	
<b>Extended rotary handle</b>				
DB439593.ai 	With black handle	LV429338	LV432598	
	With red handle on yellow front	LV429340	LV432600	
	With telescopic handle for withdrawable device	LV429343	LV432603	
<b>Accessories</b>				
Indication auxiliary		1 early-break contact	LV429345	LV432605
		2 early-break contacts	LV429346	LV429346
<b>Locks</b>				
<b>Toggle locking device for 1 to 3 padlocks</b>				
DB438109.ai 	By removable device		29370	29370
	DB438110.ai 	By fixed device (open or close position)		LV429371
By fixed device (open position only)		LV429370 <sup>[1]</sup>	LV432630 <sup>[1]</sup>	
<b>Locking of the rotary handle</b>				
DB438111.ai 	Keylock adapter (keylock not included)		LV429344	LV432604
	Keylock (keylock adapter not included)	Ronis 1351B.500	41940	41940
		Profalux KS5 B24 D4Z	42888	42888
<b>Locking of the motor mechanism modules</b>				
DB432104.eps 	Keylock adapter + Ronis keylock (special)		LV429449	LV432649
	Keylock (keylock adapter not included)	Ronis 1351B.500		41940
		Profalux KS5 B24 D4Z	42888	
<b>Interlocking</b>		NSX100-250 DC PV	NSX400-630 DC PV	
<b>Interlocking with key (2 keylocks/1 key) for rotary handles</b>				
DB438114.ai 	Keylock kit (keylock not included) <sup>[2]</sup>		LV429344	LV432604
	1 set of 2 keylocks	Ronis 1351B.500	41950	41950
		(1 key only, keylock kit not included)	Profalux KS5 B24 D4Z	42878

[1] Available February 2014.

[2] NSX100-250 DC PV only.





Catalog Numbers

# ComPacT NSX80/500 TM DC PV to NSX100/500 NA DC PV Installation

Installation Accessories

NSX100-250  
DC PV

NSX400-630  
DC PV

Front-panel escutcheons

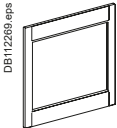

IP30

IP30 escutcheon for all control types  
IP30 trip unit access escutcheon for toggle

LV429525  
LV429526

LV432557  
LV432559

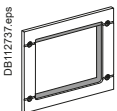

IP40

IP40 escutcheon for all control types

LV429317

LV432558

IP43 rubber toggle cover



1 toggle cover

LV429319

LV432560

Lead-sealing accessories



Bag of accessories

LV429375

LV429375

Din rail adapter

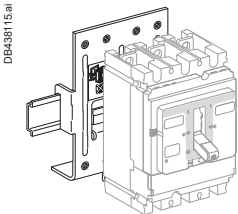

1 adapter

LV429305



# ComPacT NSX630b to 1600 NA DC PV Fixed Electrically Operated Complete Device without Motor Mechanism Module

## Complete Molded Case Switch-Disconnecter (without Motor Mechanism Module)

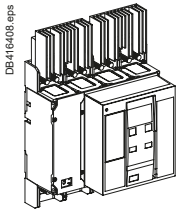

Molded case switch disconnector ComPacT NSX630b NA DC PV 630 A 4P	<b>LV438969</b>
Molded case switch disconnector ComPacT NSX800 NA DC PV 800 A 4P	<b>LV438970</b>
Molded case switch disconnector ComPacT NSX1000 NA DC PV 1000 A 4P	<b>LV438971</b>
Molded case switch disconnector ComPacT NSX1250 NA DC PV 1250 A 4P	<b>LV438972</b>
Molded case switch disconnector ComPacT NSX1600 NA DC PV 1500 A 4P	<b>LV438973</b>

**Note:** All references above include:

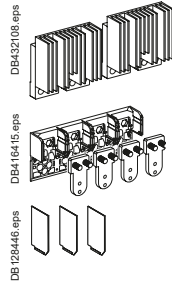

Basic frame	
Heatsink	Kit of 2 (LV438966)
Front connection:	Top (33612)
	Bottom (33613)
Interphase barriers	Kit of 3 (33646)

## Electrical Auxiliaries for Complete Device

### Indication contacts



OF, ON/OFF indication contacts	6 A - 240 V	Low level
Up to 3 OF can be connected.	<b>33108</b>	<b>33109</b>

### Instantaneous voltage releases

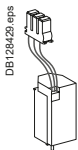

	MX	MN	Delay unit	R (non-adjustable)	Rr (adjustable)
12 V DC	<b>33658</b>				
24/30 V DC	<b>33659</b>	<b>33668</b>			
48/60 V DC	<b>33660</b>	<b>33669</b>	48/60 V DC		<b>33680</b>
100/130 V DC	<b>33661</b>	<b>33670</b>	100/130 V DC	<b>33684</b>	<b>33681</b>
200/250 V DC	<b>33662</b>	<b>33671</b>	200/250 V DC	<b>33685</b>	<b>33682</b>
			380/480 V DC		<b>33683</b>



# ComPacT NSX630b to 1600 NA DC PV Fixed Electrically Operated Device Based on Separate Components with or without Motor Mechanism Module

## Basic Frame Molded Case Switch-Disconnecter

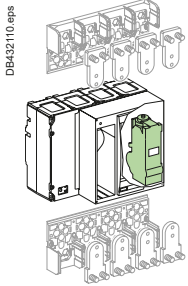

ComPacT NSX type NA		4P
NSX630b NA DC PV		<b>LV453421</b>
NSX800 NA DC PV		<b>LV453423</b>
NSX1000 NA DC PV		<b>LV453425</b>
NSX1250 NA DC PV		<b>LV453427</b>
NSX1600 NA DC PV		<b>LV453429</b>

**Note:** The characteristics of the motor mechanism module for electrical operation are specified separately by selecting a part number from the table at the bottom of this page.

## Connections for Basic Frame Molded Case Switch-Disconnecters

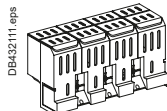
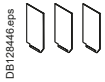
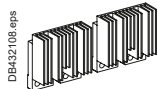
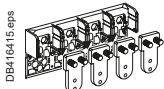

Front connection		4P
Top	630-1000 A - NA	<b>33612</b>
	Heatsink mandatory	Kit of 2 <b>LV438966</b>
Bottom	interphase barriers*	Kit of 3 <b>33646</b>
or	Terminal shield*	<b>LV438968</b>
	* interphase barriers or terminal shield is mandatory	
Front connection	630-1000 A - NA	Bottom <b>33609</b>
	630-1000 A - L	Bottom <b>33611</b>
	1600 A - NA	Bottom <b>33613</b>
Rear connection	Vertical NA	Bottom <b>33615</b>
	Horizontal NA	Bottom <b>33617</b>

## Electrical Auxiliaries

### Indication contacts



OF, ON/OFF indication contacts	6 A - 240 V	Low level
Up to 3 OF can be connected.	<b>33108</b>	<b>33109</b>

### Instantaneous voltage releases

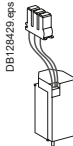

	MX	MN	Delay unit	R (non-adjustable)	Rr (adjustable)
12 V DC	<b>33658</b>				
24/30 V DC	<b>33659</b>	<b>33668</b>			
48/60 V DC	<b>33660</b>	<b>33669</b>	48/60 V DC		<b>33680</b>
100/130 V DC	<b>33661</b>	<b>33670</b>	100/130 V DC	<b>33684</b>	<b>33681</b>
200/250 V DC	<b>33662</b>	<b>33671</b>	200/250 V DC	<b>33685</b>	<b>33682</b>
			380/480 V DC		<b>33683</b>

## Communication Options

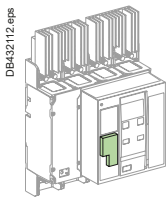

For fixed devices	Electrically operated
Modbus COM	<b>33708</b>

## Motor Mechanism Module



DC	Standard	Communicating
24/30 V	<b>33690</b>	<b>33697</b>
48/60 V	<b>33691</b>	<b>33698</b>
100/130 V	<b>33692</b>	<b>33699</b>
200/250 V	<b>33693</b>	<b>33700</b>

**Note:** To order a complete device, order:

- A basic frame switch disconnector
- Connections
- Electrical auxiliaries.
- Communication option as required.
- Motor mechanism as required.

# ComPacT INS40 to 160 DC

## Complete Fixed/FC Device and Accessories

### ComPacT INS40 to 160 Standard Version with Black Handle

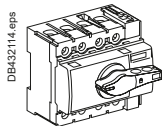

	3P	4P
ComPacT INS40	<b>28900</b>	<b>28901</b>
ComPacT INS63	<b>28902</b>	<b>28903</b>
ComPacT INS80	<b>28904</b>	<b>28905</b>
ComPacT INS80PV - Photovoltaic	-	<b>28907</b>

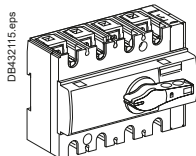

	3P	4P
ComPacT INS100	<b>28908</b>	<b>28909</b>
ComPacT INS125	<b>28910</b>	<b>28911</b>
ComPacT INS160	<b>28912</b>	<b>28913</b>

### ComPacT INS40 to 160 with Red Handle and Yellow Front

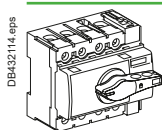

	3P	4P
ComPacT INS40	<b>28916</b>	<b>28917</b>
ComPacT INS63	<b>28918</b>	<b>28919</b>
ComPacT INS80	<b>28920</b>	<b>28921</b>

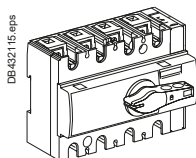



	3P	4P
ComPacT INS100	<b>28924</b>	<b>28925</b>
ComPacT INS125	<b>28926</b>	<b>28927</b>
ComPacT INS160	<b>28928</b>	<b>28929</b>



# ComPacT INS40 to 160 DC Accessories

## Connection Accessories (Cont.)

### Connectors for bare Cu or Al cables

DB432116.eps 	Snap-in	INS100 to 160 S ≤ 95 mm <sup>2</sup>	Set of 3	<b>28947</b>
			Set of 4	<b>28948</b>
DB432117.eps 	Distribution connector for 3 rigid cables up to 16 mm <sup>2</sup> or 3 flexible cables up to 10 mm <sup>2</sup>	INS40 to 80	Set of 3	<b>19096</b>
			Set of 4	<b>19091</b>
DB432118.eps 	Distribution connector for 4 rigid cables up to 25 mm <sup>2</sup> or 4 flexible cables up to 16 mm <sup>2</sup>	INS100 to 160	Set of 3	<b>28949</b>
			Set of 4	<b>28950</b>

### Crimp lugs for copper cables

DB432119.eps 	For 95 mm <sup>2</sup> cables with interphase barriers	INS100 to 160	Set of 3	<b>28951</b>
			Set of 4	<b>28952</b>

### Terminal shrouds

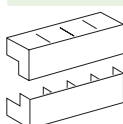
DB432120.eps 	INS40 to 80	3P/4P	Set of 2	<b>28955</b>
	INS100 to 160	3P/4P	Set of 2	<b>28956</b>

### Terminal shields

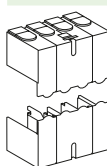
DB432121.eps 	INS40 to 80	3P/4P	Set of 2	<b>28957</b>
	INS100 to 160	3P/4P	Set of 2	<b>28958</b>

### Interphase barriers

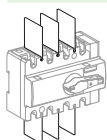
DB432122.eps 	INS100 to 160	3P/4P	Set of 6	<b>28959</b>
---	---------------	-------	----------	--------------

## Electrical Auxiliaries

### Auxiliary contacts

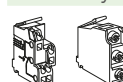
DB436418.ai 	1 CAF/CAO standard (early make or break)	INS40 to 160	<b>29450</b>
	1 CAF/CAO low level (early make or break)	INS40 to 160	<b>29452</b>

## Rotary Handles

### Direct front control or lateral control

Built-in

#### Accessories for conversion to extended rotary handles

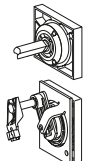
DB432124.eps 	Front control	Black handle	INS40 to 160	<b>LV428941</b>	
		Red handle on yellow front	INS40 to 160	<b>LV428942</b>	
DB432125.eps 	Lateral control	Black handle	INS40 to 160	<b>28943</b>	
		Red handle on yellow front	INS40 to 160 <sup>[1]</sup>	<b>28944</b>	
		Lateral control on PRAGMA F functional enclosure	Black handle	INS40 to 160	<b>28945<sup>[2]</sup></b>
			Red handle on yellow front	INS40 to 160 <sup>[1]</sup>	<b>28946</b>

[1] For red/yellow switch versions only.

[2] Not available with Prisma.

# Catalog Numbers ComPacT INS40 to 160 DC Accessories

## Locking and Interlocking

### Handle locking

DB432126.eps

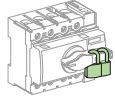

By 1 to 3 padlocks (OFF position), hasp dia. 5 to 8 mm, or by lead seals

**Built-in**

### Interlocking for extended rotary handles

DB432127.eps

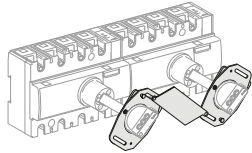

Mechanical

**28953**



# ComPacT INS250-100 to 630 DC

## Complete Fixed/FC Device and Accessories

### ComPacT INS250 to 630 Standard Version with Black Handle

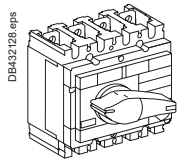

	3P	4P
ComPacT INS250-100A	<b>31100</b>	<b>31101</b>
ComPacT INS250-160A	<b>31104</b>	<b>31105</b>
ComPacT INS250-200A	<b>31102</b>	<b>31103</b>
ComPacT INS250	<b>31106</b>	<b>31107</b>

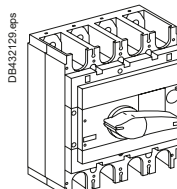

	3P	4P
ComPacT INS320	<b>31108</b>	<b>31109</b>
ComPacT INS400	<b>31110</b>	<b>31111</b>
ComPacT INS500	<b>31112</b>	<b>31113</b>
ComPacT INS630	<b>31114</b>	<b>31115</b>

### ComPacT INS250 to 630 with Red Handle and Yellow Front

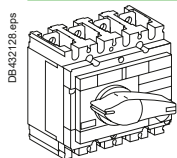

	3P	4P
ComPacT INS250-100A	<b>31120</b>	<b>31121</b>
ComPacT INS250-160A	<b>31124</b>	<b>31125</b>
ComPacT INS250-200A	<b>31122</b>	<b>31123</b>
ComPacT INS250	<b>31126</b>	<b>31127</b>

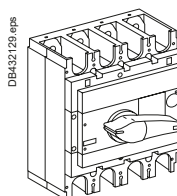

	3P	4P
ComPacT INS320	<b>31128</b>	<b>31129</b>
ComPacT INS400	<b>31130</b>	<b>31131</b>
ComPacT INS500	<b>31132</b>	<b>31133</b>
ComPacT INS630	<b>31134</b>	<b>31135</b>



# ComPacT INV100 to 630 DC

## Complete Fixed/FC Device and Specific Accessories

### ComPacT INV100 to 630 Standard Version with Black Handle

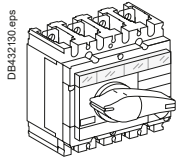

	3P	4P
ComPacT INV100	<b>31160</b>	<b>31161</b>
ComPacT INV160	<b>31164</b>	<b>31165</b>
ComPacT INV200	<b>31162</b>	<b>31163</b>
ComPacT INV250	<b>31166</b>	<b>31167</b>

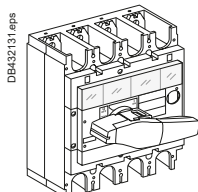

	3P	4P
ComPacT INV320	<b>31168</b>	<b>31169</b>
ComPacT INV400	<b>31170</b>	<b>31171</b>
ComPacT INV500	<b>31172</b>	<b>31173</b>
ComPacT INV630	<b>31174</b>	<b>31175</b>

### ComPacT INV100 to 630 with Red Handle and Yellow Front

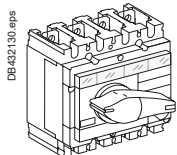

	3P	4P
ComPacT INV100	<b>31180</b>	<b>31181</b>
ComPacT INV160	<b>31184</b>	<b>31185</b>
ComPacT INV200	<b>31182</b>	<b>31183</b>
ComPacT INV250	<b>31186</b>	<b>31187</b>

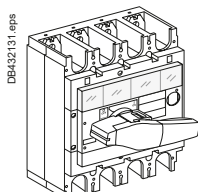











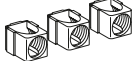

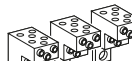
	3P	4P
ComPacT INV320	<b>31188</b>	<b>31189</b>
ComPacT INV400	<b>31190</b>	<b>31191</b>
ComPacT INV500	<b>31192</b>	<b>31193</b>
ComPacT INV630	<b>31194</b>	<b>31195</b>

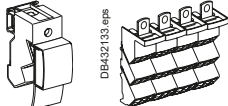

# ComPacT INS250-100 to 250 DC and ComPacT INV100 to 250 DC Accessories

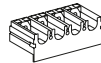
## Connection Accessories

Rear connections					
	Short (1 pair)			LV429235	
	Long (1 pair)			LV429236	
Cable connectors					
	Snap-on, for cables:	Steel: 1.5 to 95 mm <sup>2</sup> ; ≤ 160 A	Set of 3	LV429242	
			Set of 4	LV429243	
		Aluminium: 25 to 95 mm <sup>2</sup> ; ≤ 250 A	Set of 3	LV429227	
			Set of 4	LV429228	
		Aluminium: 120 to 185 mm <sup>2</sup> ; ≤ 250 A	Set of 3	LV429259	
			Set of 4	LV429260	
	Tab connector for voltage tap on 185 mm <sup>2</sup> cable connector		Set of 10	LV429348	
	Clip for cable connector		Set of 10	LV429241	
	Distribution connector for six 1.5 to 35 mm <sup>2</sup> cables with interphase barriers		Set of 3	LV429248	
			Set of 4	LV429249	
	Aluminium connectors for 2 cables: 2 x (50 to 120 mm <sup>2</sup> ); ≤ 250 A		Set of 3	LV429218	
			Set of 4	LV429219	
Linery DX and DP distribution block					
	Linery DX 160 A	For 6 cables (16 mm <sup>2</sup> ) per pole <sup>[1]</sup>	1P	04031	
	Linery DP 250 A	For 9 cables (6 x 10 mm <sup>2</sup> + 3 x 16 mm <sup>2</sup> ) per pole <sup>[1]</sup>	3P	04033	
			4P	04034	
			Additional blocks of 2 x 35 mm <sup>2</sup> per pole <sup>[1]</sup>	3P	04155
			4P	04156	
Linery DS distribution block					
	Linery DS 250 A	For 14 holes (1 x 15.3 mm <sup>2</sup> + 1 x 10 mm <sup>2</sup> + 4 x 6 mm <sup>2</sup> + 8 x 7.5 mm <sup>2</sup> )	1P	LG125014	
Terminal extensions (supplied with 2 or 3 interphase barriers)					
	Right-angle terminal extensions <sup>[1]</sup>		Set of 3	LV429261	
			Set of 4	LV429262	
	Straight terminal extensions <sup>[1]</sup>		Set of 3	LV429263	
			Set of 4	LV429264	
Spreaders (for upstream or downstream connection)					
	Separate for each pole		3P	LV431563	
			4P	LV431564	
	One-piece Front alignment base for one-piece spreader (when mounting with LV432594 and LV432596, refer chapter dimensions and connection in catalog ComPact INS/INV "LVPED213024EN")		3/4P	LV431061	
			3/4P	LV431064	
Crimp lugs for copper cables (supplied with 2 or 3 interphase barriers)					
	For 120 mm <sup>2</sup> cables		Set of 3	LV429252	
			Set of 4	LV429256	
		For 150 mm <sup>2</sup> cables		Set of 3	LV429253
				Set of 4	LV429257
	For cable 185 mm <sup>2</sup> cables		Set of 3	LV429254	
			Set of 4	LV429258	
Crimp lugs for aluminium cables (supplied with 2 or 3 interphase barriers)					
	For 150 mm <sup>2</sup> cables		Set of 3	LV429504	
			Set of 4	LV429505	
		For 185 mm <sup>2</sup> cables		Set of 3	LV429506
				Set of 4	LV429507

[1] Supplied with 2 or 3 interphase barriers.

# ComPacT INS250-100 to 250 DC and ComPacT INV100 to 250 DC Accessories

## Connection Accessories

### Terminal shields

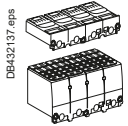
	1 Short	3/4 P	LV429516
	1 Long	3/4 P	LV429518

### Interphase barriers

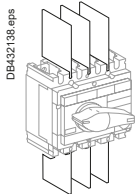
		Set of 6	LV429329
---	--	----------	----------

## Special Connection Accessories for INS250-100 to 250DC and INV100 to 250DC

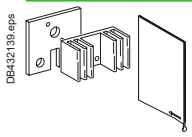
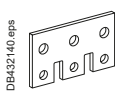
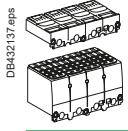
	Terminal extensions for series or parallel connection of two poles <sup>[1]</sup>	1 terminal ext.	LV438328
	Terminal extensions for parallel connection of three poles: Parallel connection of:	3 poles = set of 2 terminal extensions	LV438329
	4P terminal shields for series connection of poles	Set of 1	LV438326
	4P terminal shields for parallel connection of poles (2P/4P)	Set of 1	LV438327

## Electrical Auxiliaries

### Auxiliary contacts (changeover type)

	CAM (early make or break)	29450
	Low level CAM (early make or break)	29452

## Rotary Handles

### Front control

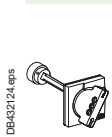
	Direct for INS/INV250	Built-in
	<b>Extended</b>	
	For INS/INV250 with standard rotary handle	LV431050
	For INS/INV250 with red handle on yellow front	<sup>[2]</sup> LV431051
	For complete source changeover assembly	31055

### Lateral control

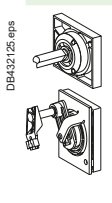
	Direct lateral control for INS/INV250	
	Lateral support	31054
	+ standard lateral control assembly	31057
	or + red and yellow lateral control assembly	<sup>[2]</sup> 31058
	Extended lateral control for INS/INV250	
	Standard lateral control assembly	31057
Red and yellow lateral control assembly	<sup>[2]</sup> 31058	

**[1]** Series connection of: 2 poles = 1 terminal extension  
3 poles = 2 terminal extensions  
4 poles = 3 terminal extensions  
Parallel connection of: 2 poles = 2 terminal extensions  
4 poles = 4 terminal extensions

**[2]** For red/yellow switch versions only.



Catalog Numbers

# ComPacT INS250-100 to 250 DC and ComPacT INV100 to 250 DC Accessories

## Locking and Interlocking for INS/INV and TransferPacT Source Changeover Systems

### Locking for INS/INV

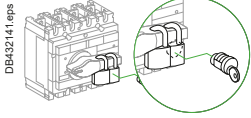

DB432142 eps	Handle locking by 1 to 3 padlocks (in OFF position)		Built-in
	By keylock	Keylocking device	2 x <b>31087</b>
		+ Ronis 1351B.500 keylock	<b>41940</b>
		or + Profalux KS5 B24 D4Z keylock	<b>42888</b>

### Locking for INS complete TransferPacT source changeover assembly

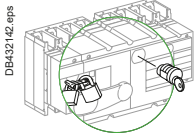

DB432142 eps	Handle locking by 1 to 3 padlocks (in OFF position)		Built-in
	By keylock	Keylocking device	<b>31097</b>
		+ Ronis 1351B.500 keylock	<b>41940</b>
		or + Profalux KS5 B24 D4Z keylock	<b>42888</b>

### Interlocking with key (2 keylocks/1 key)

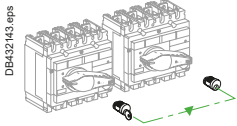

DB432143 eps	By 2 keylocks	INS250 keylocking device	2 x <b>31087</b>
		INS320-630 keylocking device	2 x <b>31088</b>
		+ Ronis 1351B.500 keylock	2 x <b>41950</b>
		or + Profalux KS5 B24 D4Z keylock	2 x <b>42878</b>



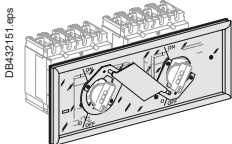



### Interlocking for INS/INV with direct or extended rotary handle

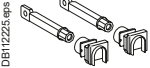

DB432151 eps	Mechanical interlocking for INS250	<b>31073</b>
--------------	------------------------------------	--------------

# ComPacT INS320 to 630 DC and ComPacT INV320 to 630 DC Accessories

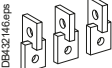
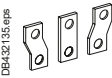
## Connection Accessories

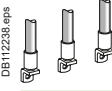
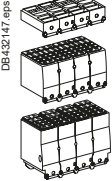
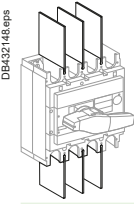
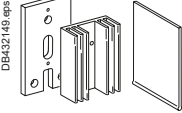
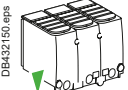
Rear connections				
	Short (1 pair)			LV432475
	Long (1 pair)			LV432476
Cable connectors				
	For 1 cable, 35 mm <sup>2</sup> to 300 mm <sup>2</sup>		Set of 3	LV432479 <sup>[1]</sup>
			Set of 4	LV432480 <sup>[2]</sup>
	For 2 cables, 35 mm <sup>2</sup> to 240 mm <sup>2</sup>		Set of 3	LV432481 <sup>[1]</sup>
			Set of 4	LV432482 <sup>[2]</sup>
	Tab connector for voltage tap on cable connector		Set of 10	LV429348
Terminal extensions (supplied with 2 or 3 interphase barriers)				
	Right-angle terminal extensions		Set of 3	LV432484
			Set of 4	LV432485
	Edgewise terminal extensions		Set of 3	LV432486
			Set of 4	LV432487
Spreaders (for upstream or downstream connection)				
	One-piece	52.5 mm	3P	LV432490
			4P	LV432491
	70 mm	3P	LV432492	
		4P	LV432493	
Crimp lugs for copper cables (supplied with 2 or 3 interphase barriers)				
	For 240 mm <sup>2</sup> cables		Set of 3	LV432500
			Set of 4	LV432501
	For 300 mm <sup>2</sup> cables		Set of 3	LV432502
			Set of 4	LV432503
Crimp lugs for aluminium cables (supplied with 2 or 3 interphase barriers)				
	For 240 mm <sup>2</sup> cables		Set of 3	LV432504
			Set of 4	LV432505
	For 300 mm <sup>2</sup> cables		Set of 3	LV432506
			Set of 4	LV432507
Terminal shields				
	1 Short		3/4P	LV432592
	1 Long		3/4P	LV432594
	1 Long for 52.5 mm spreader (supplied with insulating plate)		3/4P	LV432596
Interphase barriers				
			Set of 6	LV432570
Special connection accessories for INS/INV320 to 630DC				
	Terminal extensions for series or parallel connection of two poles <sup>[3]</sup>		1 connection plate equipped with heat sink + 1 interphase barrier	LV438338
	4P terminal shields for series connection of poles		Set of 1	LV438346
	4P terminal shields for parallel connection of poles		Set of 1	LV438337

[1] Kit comprising 2 interphase barriers.

[2] Kit comprising 3 interphase barriers.

[3] Series connection of: 2 poles = 1 terminal extension  
3 poles = 2 terminal extensions  
4 poles = 3 terminal extensions

Parallel connection of: 2 poles = 2 terminal extensions  
4 poles = 4 terminal extensions



# ComPacT INS320 to 630 DC and ComPacT INV320 to 630 DC Accessories

## Electrical Auxiliaries

### Auxiliary contacts (changeover type)

DB432115.ai

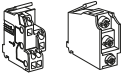

1 OF/CAF/CAO (early make or break)	<b>29450</b>
1 OF/CAF/CAO low level (early make or break)	<b>29452</b>

## Rotary Handles

### Extended front control

DB432152.eps

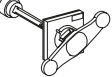

For INS320/400/630 with standard rotary handle	<b>31052</b>
For INS320/400/630 with red handle on yellow front	<b>31053</b>
For complete source changeover assembly	<b>31055</b>

## Locking and Interlocking for INS/INV and TransferPacT Source Changeover Systems

### Locking for INS/INV

DB432153

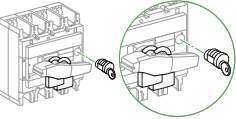

Handle locking by 1 to 3 padlocks (in OFF position)	Built-in
By keylock	Keylocking device
	+ Ronis 1351B.500 keylock
	or + Profalux KS5 B24 D4Z keylock
	<b>31088</b>
	<b>41940</b>
	<b>42888</b>

### Locking for INS complete TransferPacT source changeover assembly

DB432154.eps

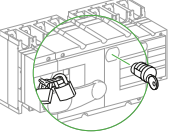

Handle locking by 1 to 3 padlocks (in OFF position)	Built-in
By keylock	Keylocking device
	+ Ronis 1351B.500 keylock
	or + Profalux KS5 B24 D4Z keylock
	<b>31097</b>
	<b>41940</b>
	<b>42888</b>

### Interlocking with key (2 keylocks/1 key)

DB432143.eps

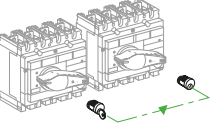

By 2 keylocks	INS250 keylocking device	2 x	<b>31087</b>
	INS320-630 keylocking device	2 x	<b>31088</b>
	+ Ronis 1351B.500 keylock	2 x	<b>41950</b>
	or + Profalux KS5 B24 D4Z keylock	2 x	<b>42878</b>

### Interlocking for INS/INV with direct or extended rotary handle

DB432155.eps

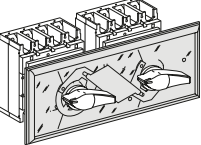

Mechanical interlocking for INS320/400/630	<b>31074</b>
--	--------------

# ComPacT INS630b to 2500 DC

## Complete Fixed/FC Device and Accessories

### ComPacT INS630b to 2500 Standard Version with Black Handle

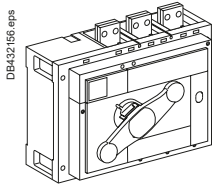

	3P	4P
ComPacT INS630b	<b>31342</b>	<b>31343</b>
ComPacT INS800	<b>31330</b>	<b>31331</b>
ComPacT INS1000	<b>31332</b>	<b>31333</b>
ComPacT INS1250	<b>31334</b>	<b>31335</b>
ComPacT INS1600	<b>31336</b>	<b>31337</b>

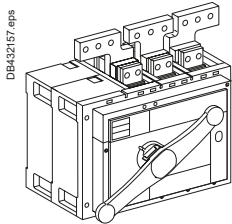

ComPacT INS2000	<b>31338</b>	<b>31339</b>
ComPacT INS2500	<b>31340</b>	<b>31341</b>

### ComPacT INS800 to 1600 with Red Handle and Yellow Front

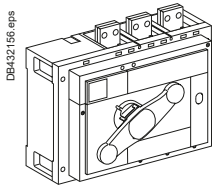

	3P	4P
ComPacT INS800	<b>31344</b>	<b>31345</b>
ComPacT INS1000	<b>31346</b>	<b>31347</b>
ComPacT INS1250	<b>31348</b>	<b>31349</b>
ComPacT INS1600	<b>31350</b>	<b>31351</b>



# ComPacT INV630b to 2500 DC

## Complete Fixed/FC Device and Specific Accessories

### ComPacT INV630b to 2500 Standard Version with Black Handle

DB432158.eps

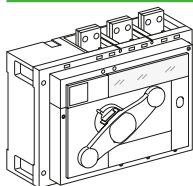

	3P	4P
ComPacT INV630b	<b>31370</b>	<b>31371</b>
ComPacT INV800	<b>31358</b>	<b>31359</b>
ComPacT INV1000	<b>31360</b>	<b>31361</b>
ComPacT INV1250	<b>31362</b>	<b>31363</b>
ComPacT INV1600	<b>31364</b>	<b>31365</b>

DB432158.eps

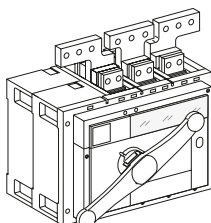

ComPacT INV2000	<b>31366</b>	<b>31367</b>
ComPacT INV2500	<b>31368</b>	<b>31369</b>

### ComPacT INV800 to 1600 with Red Handle and Yellow Front

DB432158.eps

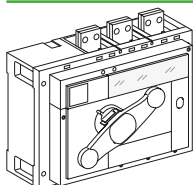

	3P	4P
ComPacT INV800	<b>31372</b>	<b>31373</b>
ComPacT INV1000	<b>31374</b>	<b>31375</b>
ComPacT INV1250	<b>31376</b>	<b>31377</b>
ComPacT INV1600	<b>31378</b>	<b>31379</b>

# ComPacT INS630b to 2500 DC and ComPacT INV630b to 2500 DC Accessories

## Connection Accessories

### Vertical connection adapters

	INS/INV630b-1600	3P	Set of 3	<b>31301</b>
		4P	Set of 4	<b>31302</b>

### Cable lug adapters

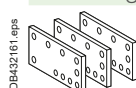
	INS/INV630b-1600	3P	Set of 3	<b>33644</b>
		4P	Set of 4	<b>33645</b>

### Busbar connection (not compatible with terminal shield)

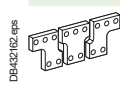
	INS/INV630b-1600	3P	Set of 3	<b>31305</b>
		4P	Set of 4	<b>31306</b>

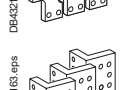
	Right angle connector for busbar (edgewise) to INS2000/2500			<b>31310</b>
---	---	--	--	--------------

## Insulation Accessories

### Base for terminal shield (not compatible with interphase barriers)

	INS/INV630b-1600	3P		<b>31307</b>
		4P		<b>31308</b>

### Terminal shield

	INS/INV630b-1600	3P		<b>LV433638</b>
		4P		<b>LV433639</b>

### Interphase barriers (not compatible with terminal shield and base)

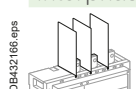
	INS/INV630b-1600	4P	Set of 6	<b>31315</b>
	INS/INV2000/2500	4P	Set of 6	<b>31319</b>

## Electrical Auxiliaries

### Auxiliary contacts (changeover type) INS/INV630b-2500

	1 OF/CAF/CAO standard (early make or break)			<b>29450</b>
	1 OF/CAF/CAO low level (early make or break)			<b>29452</b>

### Extended Front Control

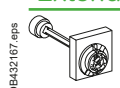
	INS/INV630b-2500	For standard rotary handle		<b>31288</b>
	INS/INV630b-1600	For red handle on yellow front	[1]	<b>31289</b>

[1] For red/yellow switch versions only.

# ComPacT INS630b to 2500 DC and ComPacT INV630b to 2500 DC Accessories

## Locking and Interlocking

### Locking for INS/INV630b to 2500

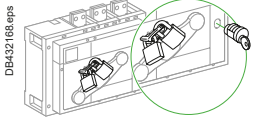

Handle locking by 1 to 3 padlocks (in OFF position)

By keylock

Built-in	
Keylocking device	<b>31291</b>
+ Ronis 1351B.500 keylock	<b>41940</b>
or + Profalux KS5 B24 D4Z keylock	<b>42888</b>

### Interlocking for INS/INV630b to 2500

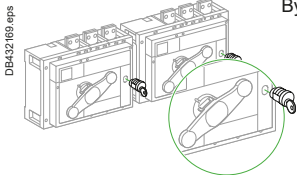

By keylock

Keylocking device	2 x	<b>31291</b>
+ Ronis 1351B.500 keylock (1 key)	2 x	<b>41950</b>
or + Profalux KS5 B24 D4Z keylock (1 key)	2 x	<b>42878</b>

# NW10 DC to NW40 DC Fixed and Drawout Circuit Breakers and Switch-Disconnectors

A MasterPact DC circuit breaker is described by 2 catalog numbers corresponding to:

- The basic circuit breaker (fixed or drawout with chassis, including the power connections)
- A control unit.

A MasterPact switch-disconnector is described by 1 catalog number corresponding to:

- The switch-disconnector (fixed or drawout with chassis, including the power connections). Vertical connection is standard however the connectors can be rotated for on-site conversion to horizontal connection (except on the NW40). A communication option and various auxiliaries and accessories may also be added.

DB101915.eps

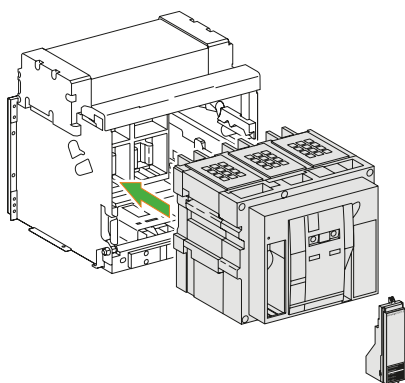

Basic circuit breaker + chassis ≤ 4000 A

DB04413.eps

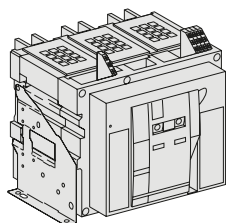

Switch-disconnector ≤ 4000 A

## Basic Circuit Breaker

Type N				
	In (A at 40 °C)	Icu (kA for U = 500 V DC)	Fixed	Drawout
NW10NDC-C	1000	35	<b>48645</b>	<b>48660</b>
NW20NDC-C	2000	35	<b>48646</b>	<b>48661</b>
NW40NDC-C	4000	35	<b>48647</b>	<b>48662</b>
Type H				
	In (A at 40 °C)	Icu (kA for U = 500 V DC)	Fixed	Drawout
NW10HDC-C	1000	85	<b>48648</b>	<b>48663</b>
NW10HDC-D	1000	85	<b>48649</b>	<b>48664</b>
NW10HDC-E	1000	85	<b>48650</b>	<b>48665</b>
NW20HDC-C	2000	85	<b>48651</b>	<b>48666</b>
NW20HDC-D	2000	85	<b>48652</b>	<b>48667</b>
NW20HDC-E	2000	85	<b>48653</b>	<b>48668</b>
NW40HDC-C	4000	85	<b>48654</b>	<b>48669</b>
NW40HDC-D	4000	85	<b>48655</b>	<b>48670</b>
NW40HDC-E	4000	85	<b>48656</b>	<b>48671</b>

## Circuit Breaker for Marine Application at 1100 V DC

Type EPCD				
	In (A at 40 °C)	Icu (kA for U = 1100 V DC, L/R = 15 ms)	No Fixed Version	Drawout
NW10 EPDC-D	1000	65		<b>46921</b>
NW20 EPDC-D	2000	65		<b>46922</b>
NW40 EPDC-D	4000	65		<b>46924</b>

## DC 1.0 MicroLogic Control Unit

Setting range				
Minimum (A ±8 %)	Maximum (E ±10 %)	Type	Fixed	Drawout
1250	2500	N, H type C	<b>65266</b>	<b>65269</b>
2500	5400	N, H type C	<b>65267</b>	<b>65270</b>
5000	11000	N, H type C	<b>65268</b>	<b>65271</b>
1250	2500	H type D	<b>65272</b>	<b>65275</b>
2500	5400	H type D	<b>65273</b>	<b>65276</b>
5000	11000	H type D	<b>65274</b>	<b>65277</b>
1250	2500	H type E	<b>65278</b>	<b>65281</b>
2500	5400	H type E	<b>65279</b>	<b>65282</b>
5000	11000	H type E	<b>65280</b>	<b>65283</b>

## Switch-Disconnecter

Type HA				
	In (A at 40 °C)	Icm (kA)	Fixed	Drawout
NW10HADC-C	1000	85	<b>48684</b>	<b>48698</b>
NW10HADC-D	1000	85	<b>48685</b>	<b>48699</b>
NW10HADC-E	1000	85	<b>48879</b>	<b>48882</b>
NW20HADC-C	2000	85	<b>48687</b>	<b>48701</b>
NW20HADC-D	2000	85	<b>48688</b>	<b>48702</b>
NW20HADC-E	2000	85	<b>48880</b>	<b>48883</b>
NW40HADC-C	4000	85	<b>48690</b>	<b>48704</b>
NW40HADC-D	4000	85	<b>48691</b>	<b>48705</b>
NW40HADC-E	4000	85	<b>48881</b>	<b>48884</b>

## Switch-Disconnecter for PV Application

Type HADCD-PV				
	In	Icm (kA)	Fixed	Drawout
NW20HADCD-PV	2000	85	<b>48975</b>	<b>47651</b>
NW40HADCD-PV	4000	85	<b>48977</b>	<b>47652</b>



Catalog Numbers

# NW10 DC to NW40 DC Fixed Circuit Breakers Indication Contacts

ON/OFF indication contacts (OF)

DB404314.eps

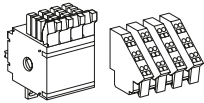

Block of 4 changeover contacts (6 A - 240 V)	1 block (standard)
1 additional block of 4 contacts (2 max.)	<b>48198</b>

"Fault trip" indication contacts (SDE)

DB404315.eps

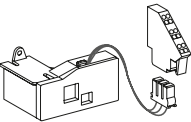

Changeover contact (5 A - 240 V)	1 (standard)
1 additional SDE (5 A - 240 V)	<b>48200</b>
1 additional low-level SDE	<b>48201</b>



# NW10 DC to NW40 DC Fixed Circuit Breakers

## Remote Operation

### Remote ON/OFF

#### Gear motor

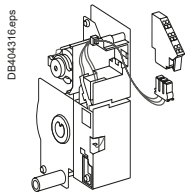

DB404316 eps	AC 50/60 Hz	48 V	<b>MCH</b>	
		100/130 V	<b>48207</b>	
		200/240 V	<b>48211</b>	
		250/277 V	<b>48212</b>	
		380/415 V	<b>48213</b>	
		440/480 V	<b>48214</b>	
	DC	24/30 V	<b>48215</b>	
		48/60 V	<b>48206</b>	
		100/130 V	<b>48207</b>	
		200/250 V	<b>48208</b>	
		200/250 V	<b>48209</b>	

#### Instantaneous voltage releases

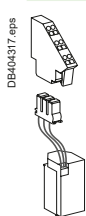

		Closing release	Opening release	
DB404317 eps	<b>Standard</b>	<b>XF</b>	<b>MX</b>	
	AC 50/60 Hz	12 V DC	<b>47349</b>	<b>47359</b>
		24/30 V DC, 24 V AC	<b>47350</b>	<b>47360</b>
		48/60 V DC, 48 V AC	<b>47351</b>	<b>47361</b>
		100/130 V AC/DC	<b>47352</b>	<b>47362</b>
		200/250 V AC/DC	<b>47353</b>	<b>47363</b>
		277 V AC	<b>47354</b>	<b>47364</b>
	DC	380/480 V AC	<b>47355</b>	<b>47365</b>
		<b>Communicating</b>	<b>XF com</b>	<b>MX com</b>
		AC 50/60 Hz	12 V DC	<b>47310</b>
24/30 V DC, 24 V AC			<b>47311</b>	<b>47321</b>
DC	48/60 V DC, 48 V AC	<b>47312</b>	<b>47322</b>	
	100/130 V AC/DC	<b>47313</b>	<b>47323</b>	
	200/250 V AC/DC	<b>47314</b>	<b>47324</b>	
	277 V AC	<b>47315</b>	<b>47325</b>	
	380/480 V AC	<b>47316</b>	<b>47326</b>	

#### “Ready to close” contact (1 max.)



DB404318 eps		<b>PF</b>
	1 changeover contact (5 A - 240 V)	<b>47342</b>
	1 low-level changeover contact	<b>47343</b>

#### Electrical closing pushbutton

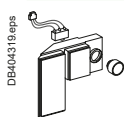

DB404319 eps	1 pushbutton	<b>BPFE</b>
		<b>48534</b>

#### Remote reset after fault trip



DB404315 eps	<b>Electrical reset</b>	<b>RES</b>
	110/130 V AC	<b>48202</b>
	220/240 V AC	<b>48203</b>
	<b>Automatic reset</b>	<b>RAR</b>
	Adaptation	<b>47346</b>

### Remote Tripping

#### Instantaneous voltage release

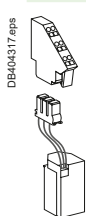

DB404317 eps	AC 50/60 Hz	12 V DC	<b>2<sup>nd</sup> MX</b>	or	<b>MN</b>
		24/30 V DC, 24 V AC	<b>47369</b>		<b>47380</b>
	DC	48/60 V DC, 48 V AC	<b>47370</b>		<b>47381</b>
		100/130 V AC/DC	<b>47371</b>		<b>47382</b>
		200/250 V AC/DC	<b>47372</b>		<b>47383</b>
		277 V AC	<b>47373</b>		
		380/480 V AC	<b>47374</b>		
			<b>47375</b>		<b>47385</b>

#### MN delay unit

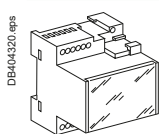

DB404320 eps	AC 50/60 Hz	48/60 V AC/DC	<b>R (non-adjustable)</b>	<b>Rr (adjustable)</b>
		100/130 V AC/DC	<b>33684</b>	<b>33680</b>
	DC	200/250 V AC/DC	<b>33685</b>	<b>33681</b>
		380/480 V AC/DC		<b>33682</b>
				<b>33683</b>



# NW10 DC to NW40 DC Drawout Circuit Breakers Indication Contacts

## ON/OFF indication contacts (OF)

DB404321.eps

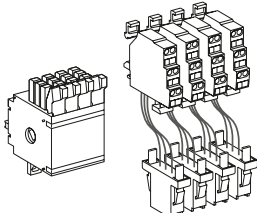

Block of 4 changeover contacts (6 A - 240 V)	1 block (standard)
1 additional block of 4 contacts (2 max.)	<b>48468</b>

## Combined closed/connected contacts for use with 1 auxiliary contact

DB404322.eps

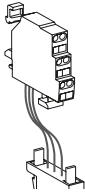

1 contact (5 A - 240 V) (8 max.)	<b>48477</b>
or 1 low-level contact (8 max.)	<b>48478</b>

## "Fault trip" indication contacts (SDE)

DB404323.eps

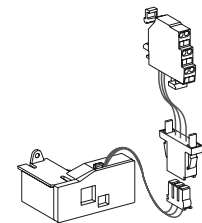

Changeover contact (5 A - 240 V)	1 (standard)
1 additional SDE (5 A - 240 V)	<b>48475</b>
or 1 additional low-level SDE	<b>48476</b>

## Carriage switches (connected/disconnected/test position)

DB404324.eps

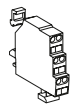





<b>Changeover contacts (8 A - 240V)</b>	
1 connected position contact (3 max.)	<b>33751</b>
1 test position contact (3 max.)	<b>33752</b>
1 disconnected position contact (3 max.)	<b>33753</b>
<b>and/or low-level changeover contacts</b>	
1 connected position contact (3 max.)	<b>33754</b>
1 test position contact (3 max.)	<b>33755</b>
1 disconnected position contact (3 max.)	<b>33756</b>
Actuator for additional carriage switches	<b>48560</b>

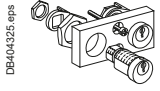

# NW10 DC to NW40 DC Drawout Circuit Breakers (Cont.)

## Chassis Locking and Accessories

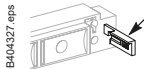
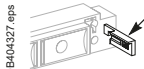
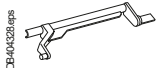
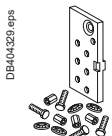
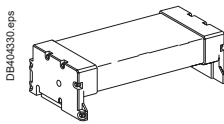
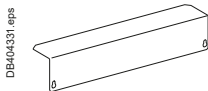
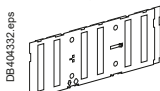
### Chassis Locking

<b>"Disconnected" position locking</b>				
	By padlocks		VPOC	Standard
	By Profalux keylocks			
	Profalux		1 lock with 1 key + adaptation kit	<b>48568</b>
			2 locks 1 key + adaptation kit	<b>48569</b>
			2 locks 2 different keys + adaptation kit	<b>48570</b>
	1 keylock Profalux (without adaptation kit):		Identical key not identified combination	<b>33173</b>
			Identical key identified 215470 combination	<b>33174</b>
			Identical key identified 215471 combination	<b>33175</b>
	By Ronis keylocks			
	Ronis		1 lock with 1 key + adaptation kit	<b>48572</b>
			2 locks 1 key + adaptation kit	<b>48573</b>
			2 locks 2 different keys + adaptation kit	<b>48574</b>
	1 keylock Ronis (without adaptation kit):		Identical key not identified combination	<b>33189</b>
			Identical key identified EL24135 combination	<b>33190</b>
			Identical key identified EL24153 combination	<b>33191</b>
		Identical key identified EL24315 combination	<b>33192</b>	
		Optional disconnected/test/connected position locking	<b>33779</b>	
Adaptation kit (without keylock):		Adaptation kit Profalux/Ronis	<b>48564</b>	
		Adaptation kit Kirk	<b>48565</b>	
		Adaptation kit Castell	<b>48566</b>	
<b>Door interlock (1 part)</b>				
	Right-hand side of chassis		<b>48579</b>	
	Left-hand side of chassis		<b>48580</b>	
<b>Racking interlock</b>				
	1 part		<b>48582</b>	
	<b>Racking interlock between crank and OFF pushbutton</b>			
	1 part		<b>48585</b>	
	<b>Automatic spring discharge before breaker removal</b>			
	1 part		<b>48554</b>	
	<b>Breaker mismatch protection</b>			
	Breaker mismatch protection VDC		<b>33767</b>	
	<b>Chassis Accessories</b>			
<b>Arc chute cover</b>				
	3P/4P		Standard	
	<b>Auxiliary terminal shield (CB)</b>			
	1000/4000 A		<b>48595</b>	
	3P		<b>48596</b>	
4P				
<b>Safety shutters + locking block</b>				
	1000/4000 A		Standard	
	3P		Standard	
4P				
<b>Shutter locking block (for replacement)</b>				
	2 parts for 1000/4000 A		<b>48591</b>	
	<b>Front face shutter position indication and locking</b>			
	1000/4000 A		<b>48592</b>	
	3P/4P			

F

# NW10 DC to NW40 DC Drawout Circuit Breakers

## Remote Operation

### Remote ON/OFF

#### Gear motor

DB404334.eps

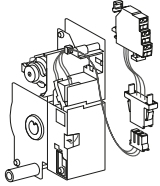

			MCH
AC 50/60 Hz	48 V		48522
	100/130 V		48526
	200/240 V		48527
	250/277 V		48528
	380/415 V		48529
	440/480 V		48530
DC	24/30 V		48521
	48/60 V		48522
	100/130 V		48523
	200/250 V		48524

#### Instantaneous voltage releases

DB404335.eps

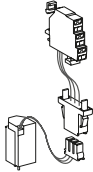

			Closing release	Opening release
<b>Standard</b>	AC 50/60 Hz DC	12 V DC	<b>XF</b>	<b>MX</b>
		24/30 V DC, 24 V AC	48480	48490
		48/60 V DC, 48 V AC	48481	48491
		100/130 V AC/DC	48482	48492
		200/250 V AC/DC	48483	48493
		277 V AC	48484	48494
		380/480 V AC	48485	48495
<b>Communicating</b>	AC 50/60 Hz DC	12 V DC	48486	48496
		24/30 V DC, 24 V AC	<b>XF com</b>	<b>MX com</b>
		48/60 V DC, 48 V AC	48448	48457
		100/130 V AC/DC	48449	48458
		200/250 V AC/DC	48450	48459
		277 V AC	48451	48460
		380/480 V AC	48452	48461
		48453	48462	
		48454	48463	

#### "Ready to close" contact (1 max.)

DB404336.eps

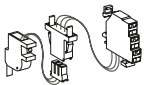

		PF
1 changeover contact (5 A - 240 V) 1 low-level changeover contact		48469
		48470

#### Electrical closing pushbutton

DB404319.eps

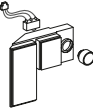

		BPFE
1 pushbutton		48534

#### Remote reset after fault trip

DB404323.eps

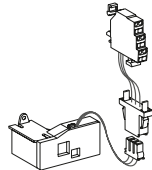

Electrical reset	110/130 V AC	RES
	220/240 V AC	48472
	Automatic reset	48473
Adaptation		RAR
		47346

### Remote Tripping

#### Instantaneous voltage release

DB404335.eps

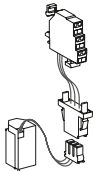

			2 <sup>nd</sup> MX	or	MN
AC 50/60 Hz DC	12 V DC		48510		
	24/30 V DC, 24 V AC		48511		48501
	48/60 V DC, 48 V AC		48512		48502
	100/130 V AC/DC		48513		48503
	200/250 V AC/DC		48514		48504
	277 V AC		48515		
	380/480 V AC		48516		48506

#### MN delay unit

DB404320.eps

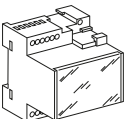

			R (non-adjustable)	Rr (adjustable)
AC 50/60 Hz DC	48/60 V AC/DC			33680
	100/130 V AC/DC		33684	33681
	200/250 V AC/DC		33685	33682
	380/480 V AC/DC			33683

# Accessories for NW10 DC to NW40 DC Fixed and Drawout Circuit Breakers

## Circuit Breaker Locking

### Pushbutton locking device

DB404337.eps

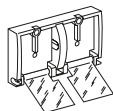

By padlocks	<b>48536</b>
-------------	--------------

### OFF position locking

DB404338.eps

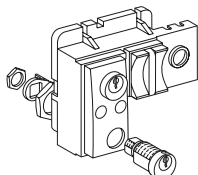

<b>By padlocks</b>		
	VPOC	<b>48539</b>
<b>By Profalux keylocks</b>		
Profalux	1 lock with 1 key + adaptation kit	<b>48545</b>
	2 locks 1 key + adaptation kit	<b>48546</b>
	2 locks 2 different keys + adaptation kit	<b>48547</b>
1 keylock Profalux (without adaptation kit)	Identical key not identified combination	<b>33173</b>
	Identical key identified 215470 combination	<b>33174</b>
	Identical key identified 215471 combination	<b>33175</b>
<b>By Ronis keylocks</b>		
Ronis	1 lock with 1 key + adaptation kit	<b>48549</b>
	2 locks 1 key + adaptation kit	<b>48550</b>
	2 locks 2 different keys + adaptation kit	<b>48551</b>
1 keylock Ronis (without adaptation kit)	Identical key not identified combination	<b>33189</b>
	Identical key identified EL24135 combination	<b>33190</b>
	Identical key identified EL24153 combination	<b>33191</b>
	Identical key identified EL24315 combination	<b>33192</b>
Adaptation kit (without keylock):	Adaptation kit Profalux/Ronis	<b>48541</b>
	Adaptation kit Kirk	<b>48542</b>
	Adaptation kit Castell	<b>48543</b>

## Other Circuit Breaker Accessories

### Mechanical operation counter

DB126620.eps



Operation counter CDM	<b>48535</b>
-----------------------	--------------

### Escutcheon and accessories

DB404339.eps

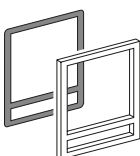

DB404340.eps



DB404341.eps

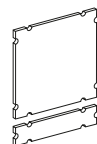

Escutcheon

Cover

Blanking plate

	Fixed	Drawout
Escutcheon	<b>48601</b>	<b>48603</b>
Transparent cover IP54		<b>48604</b>
Escutcheon blanking plate	<b>48605</b>	<b>48605</b>



# Spare Parts: MasterPact NW DC, EPDC, DC PV Connection

## Connection

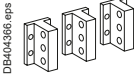
		C or D type	E type	
Fixed or drawout circuit breakers or switches				
Rear connection (vertical or horizontal mounting)/Replacement kit (3 or 4 parts)				
	1000/2000 A	Vertical or horizontal Top or bottom	<b>47966</b>	<b>47967</b>
	4000 A	Vertical or horizontal Top or bottom	<b>47968</b>	<b>47969</b>

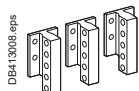

Vertical mounting



## Connection Accessories

Additional support brackets for mounting on a backplate		
	For fixed rear-connected circuit breaker (2 parts)	<b>47829</b>

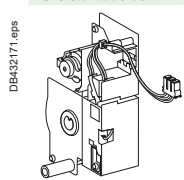

# Spare Parts: MasterPact NW DC, EPDC, DC PV Remote Operation

## Remote Operation

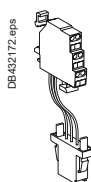

### Gear motor

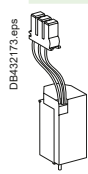
	<b>MCH (1 part)</b>		
	AC 50/60 Hz	48 V	47889
		100/130 V	47893
		200/240 V	47894
		250/277 V	47895
		380/415 V	47896
		440/480 V	47897
	DC	24/30 V	47888
		48/60 V	47889
		100/125 V	47890
200/250 V		47891	
Terminal block (1 part)	For fixed circuit breaker	47074	
	For drawout circuit breaker	47849	
	Fixed		Drawout
Installation manual		47951	

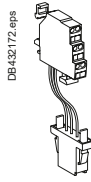
### Closing and opening release (XF or MX)

	<b>Standard coil (1 part)</b>		
	AC 50/60 Hz	12 V DC	33658
		24/30 V DC, 24 V AC	33659
		48/60 V DC, 48 V AC	33660
		100/130 V AC/DC	33661
		200/250 V AC/DC	33662
		277 V AC	33663
	DC	380/480 V AC	33664
		<b>Communicating coil (1 part)</b>	
		12 V DC	33032
24/30 V DC, 24 V AC		33033	
AC 50/60 Hz	48/60 V DC, 48 V AC	33034	
	100/130 V AC/DC	33035	
	200/250 V AC/DC	33036	
	277 V AC	33037	
	380/480 V AC	33038	
	DC	Terminal block (1 part)	For fixed circuit breaker
For drawout circuit breaker		47849	
	Fixed		Drawout
Installation manual		47951	

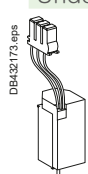
### Undervoltage release MN

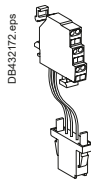
	<b>Undervoltage release (1 part)</b>			
	AC 50/60 Hz	24/30 V DC, 24 V AC	33668	
		48/60 V DC, 48 V AC	33669	
		100/130 V AC/DC	33670	
		200/250 V AC/DC	33671	
		380/480 V AC	33673	
		DC	Terminal block (1 part)	For fixed circuit breaker
	For drawout circuit breaker		47849	
	<b>Undervoltage release (1 part)</b>			
	24/30 V DC, 24 V AC		33668	
AC 50/60 Hz	48/60 V DC, 48 V AC	33669		
	100/130 V AC/DC	33670		
	200/250 V AC/DC	33671		
	380/480 V AC	33673		
	DC	Terminal block (1 part)	For fixed circuit breaker	47074
		For drawout circuit breaker	47849	
	Fixed		Drawout	
Installation manual		47951		

### MN delay unit

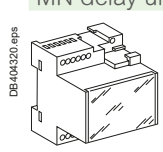
	<b>MN delay unit (1 part)</b>			
	AC 50/60 Hz	48/60 V AC/DC	R (non-adjustable)	R (adjustable)
		100/130 V AC/DC	33684	33681
		200/250 V AC/DC	33685	33682
		380/480 V AC/DC		33683
		Installation manual		47951
DC	48/60 V AC/DC		33680	
	100/130 V AC/DC	33684	33681	
	200/250 V AC/DC	33685	33682	
	380/480 V AC/DC		33683	
Installation manual			47951	



# Spare Parts: MasterPact NW DC, EPDC, DC PV Chassis Locking and Accessories

## Chassis Locking

### "Disconnected" position locking/1 part

DB404325.eps

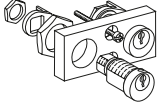

By padlocks		VCPO	Standard
By Profalux keylocks			
Profalux	1 lock with 1 key + adaptation kit		<b>64934</b>
	2 locks 1 key + adaptation kit		<b>64935</b>
	2 locks 2 different keys + adaptation kit		<b>64936</b>
1 keylock Profalux (without adaptation kit):	identical key not identified combination		<b>33173</b>
	identical key identified 215470 combination		<b>33174</b>
	identical key identified 215471 combination		<b>33175</b>
By Ronis keylocks			
Ronis	1 lock with 1 key + adaptation kit		<b>64937</b>
	2 locks 1 key + adaptation kit		<b>64938</b>
	2 locks 2 different keys + adaptation kit		<b>64939</b>
1 keylock Ronis (without adaptation kit):	identical key not identified combination		<b>33189</b>
	identical key identified EL24135 combination		<b>33190</b>
	identical key identified EL24153 combination		<b>33191</b>
	identical key identified EL24315 combination		<b>33192</b>
Adaptation kit (without keylock):	adaptation kit Profalux/Ronis		<b>48564</b>
	adaptation kit Kirk		<b>48565</b>
	adaptation kit Castell		<b>48566</b>
Installation manual			<b>47952</b>

### Door interlock/1 part

DB432174.eps

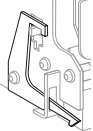

Right and left-hand side of chassis (VPECD or VPECG)	<b>47914</b>
--	--------------

Installation manual	<b>47952</b>
---------------------	--------------

### Racking interlock

DB432175.eps

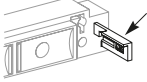

5 parts	<b>64940</b>
---------	--------------

Installation manual	<b>47952</b>
---------------------	--------------

### Breaker mismatch protection/1 part

DB-404329.eps

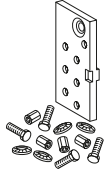

Breaker mismatch protection (VDC)	<b>33767</b>
-----------------------------------	--------------

Installation manual	<b>47952</b>
---------------------	--------------

## Chassis Accessories

### Auxiliary terminal shield (CB)/1 part

DB404331.eps

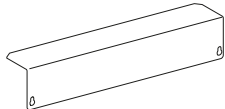

800/4000 A	3P	<b>64942</b>
	4P	<b>48596</b>
4000b/6300 A	3P	<b>48597</b>
	4P	<b>48598</b>

### Safety shutters + locking block/1 part

DB404332.eps

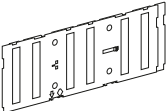

800/4000 A	3P	<b>48721</b>
	4P	<b>48723</b>
4000b/6300 A	3P	<b>48722</b>
	4P	<b>48724</b>
Installation manual		<b>47952</b>

### Shutter locking block (for replacement)/1 part

DB404333.eps



2 parts for 800/4000 A	<b>48591</b>
------------------------	--------------

Installation manual	<b>47952</b>
---------------------	--------------

## Earthing Kit for Chassis

3P	4P
----	----

### Types for N1/H1/NA/HA

<b>48433</b>	<b>48434</b>
--------------	--------------

**Note:** The installation manual is enclosed.

# Spare Parts: MasterPact NW DC, EPDC, DC PV Clusters

## Clusters

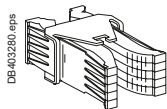

DB403200.eps

1 disconnecting contact cluster for chassis (see table below) (part 1) **64906**

Table: number of clusters required for the different chassis models

Chassis rating (A)	MasterPact NW 3P				MasterPact NW 4P			
	N1	H1/H2	H3	L1	N1	H1/H2	H3	L1
250		12 (H1)						
630	6	12		24	8	16		32
800	6	12		24	8	16		32
1000	6	12		24	8	16		32
1250	6	12		24	8	16		32
1600	12	12		24	16	16		32
2000		24	24	42		32	32	56
2500		24	24			32	32	
3200		36	36			48	48	
4000		42	42			56	56	
4000b		72				96		
5000		72				96		
6300		72				96		

**Note:** The minimum order is 6 parts.

## Racking handle

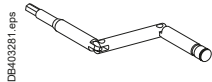

DB403201.eps

Racking handle **47944**

## DC Rear Connection

### Serial connection kit

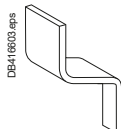

DB416005.eps

For NW10/20 DC **48642**

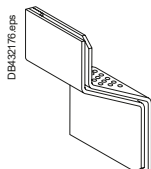

DB432170.eps

For NW40 DC **48643**





# Spare Parts: MasterPact NW DC, EPDC, DC PV

## Circuit Breaker Locking and Accessories

### Mechanical Interlocking for Source Changeover

#### Circuit Breaker Locking

##### Pushbutton locking device/1 part

DB40437.eps

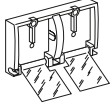

By padlocks	<b>48536</b>
-------------	--------------

Installation manual	<b>47951</b>
---------------------	--------------

##### OFF position locking/1 part

DB40441.eps

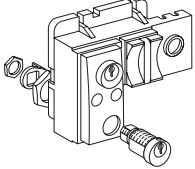

By padlocks	<b>48539</b>
-------------	--------------

By Profalux keylocks		
Profalux	1 lock with 1 key + adaptation kit	<b>64928</b>
	2 locks 1 key + adaptation kit	<b>64929</b>
	2 locks 2 different keys + adaptation kit	<b>64930</b>
1 keylock Profalux (without adaptation kit):	identical key not identified combination	<b>33173</b>
	identical key identified 215470 combination	<b>33174</b>
	identical key identified 215471 combination	<b>33175</b>

By Ronis keylocks		
Ronis	1 lock with 1 key + adaptation kit	<b>64931</b>
	2 locks 1 key + adaptation kit	<b>64932</b>
	2 locks 2 different keys + adaptation kit	<b>64933</b>
1 keylock Ronis (without adaptation kit):	identical key not identified combination	<b>33189</b>
	identical key identified EL24135 combination	<b>33190</b>
	identical key identified EL24153 combination	<b>33191</b>
	identical key identified EL24315 combination	<b>33192</b>
	Adaptation kit (without keylock):	adaptation kit Profalux/Ronis
	adaptation kit Kirk	<b>64927</b>
	adaptation kit Castell	<b>64926</b>
Installation manual		<b>47951</b>

#### Other Circuit Breaker Accessories

##### Mechanical operation counter/1 part

DB128617.eps



Operation counter CDM	<b>48535</b>
-----------------------	--------------

Installation manual	<b>47951</b>
---------------------	--------------

##### Escutcheon and accessories/1 part

DB432177.eps

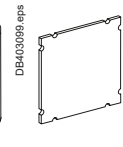
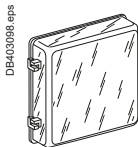
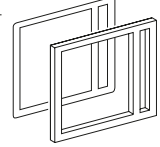

	Fixed	Drawout
Escutcheon	<b>48601</b>	<b>48603</b>
Transparent cover (IP 54)		<b>48604</b>
Escutcheon blanking plate	<b>48605</b>	<b>48605</b>

Escutcheon	Cover	Blanking plate	Installation manual	<b>47951</b>
------------	-------	----------------	---------------------	--------------

##### Spring charging handle/1 part

DB404413.eps



Spring charging handle	<b>47940</b>
------------------------	--------------

Installation manual	<b>47951</b>
---------------------	--------------

##### Arc chute for MasterPact NW/1 part

DB432178.eps

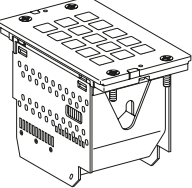

Type NW DC	C type	D type	E type
2 x	<b>47934</b>	3 x <b>47934</b>	4 x <b>47934</b>

Installation manual	<b>47951</b>
---------------------	--------------

#### Cable-Type Door Interlock

1 complete assembly for MasterPact NW fixed or drawout device	<b>48614</b>
---	--------------

**Note:** The installation manual is enclosed.

# Spare Parts: MasterPact NW DC, EPDC, DC PV Indication Contacts

## Indication Contacts

### ON/OFF indication contacts (OF)/12 parts

DB432176.eps

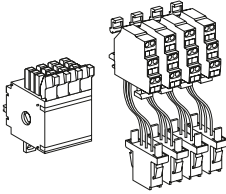

1 additional block of 4 contacts		<b>64922</b>
Wiring	For fixed circuit breaker	<b>47074</b>
	For drawout circuit breaker	<b>47849</b>

Installation manual		<b>47951</b>
---------------------	--	--------------

### "Fault trip" indication contacts (SDE)/1 part

DB432180.eps

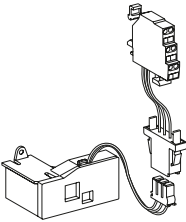

Changeover contact (SDE)	6 A - 240 V	<b>47915</b>
	Low-level	<b>47916</b>
Wiring	For fixed circuit breaker	<b>47074</b>
	For drawout circuit breaker	<b>47849</b>

Installation manual		<b>47951</b>
---------------------	--	--------------

### "Ready to close" contact (1 max.)/1 part

DB432181.eps



1 changeover contact (5 A - 240 V)		<b>47080</b>
1 low-level changeover contact		<b>47081</b>
Wiring	For fixed circuit breaker	<b>47074</b>
	For drawout circuit breaker	<b>47849</b>

Installation manual		<b>47951</b>
---------------------	--	--------------

### "Connected, disconnected, test position" indication contact (carriage switches)/1 part

DB404324.eps

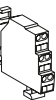

Changeover contacts	6 A - 240 V	<b>33170</b>
CE, CD, CT	Low-level	<b>33171</b>

Installation manual		<b>47952</b>
---------------------	--	--------------

### Set of additional actuators for carriage switches/1 set

1 set		<b>48560</b>
-------	--	--------------

### Combined closed/connected contacts for use with 1 auxiliary contact/1 part

DB432172.eps

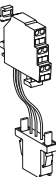

1 contact (5 A - 240 V)		<b>48477</b>
or 1 low-level contact		<b>48478</b>

Installation manual		<b>47952</b>
---------------------	--	--------------

### Electrical closing pushbutton/1 part

DB432182.eps

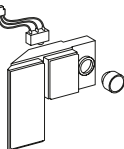

1 pushbutton		<b>48534</b>
--------------	--	--------------

Installation manual		<b>47951</b>
---------------------	--	--------------

### Auxiliary terminals for chassis alone

3 wire terminal (1 part)		<b>47849</b>
6 wire terminal (1 part)		<b>47850</b>
Jumpers (10 parts)		<b>47900</b>



# Spare Parts: MasterPact NW DC, EPDC, DC PV Instructions

## Instructions

Chassis accessories		<b>47952</b>
Circuit breaker accessories		<b>47951</b>
Fixed and drawout circuit breaker		<b>47950</b>
User manual	NW DC (French)	<b>64923</b>
	NW DC (English)	<b>64924</b>
Modbus communication notice for manual		<b>33088</b>

# Spare Parts: MasterPact NW DC, EPDC, DC PV Monitoring and Control Converter

## Monitoring and Control

### ULP display module

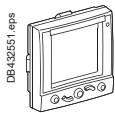

Switchboard front display module FDM121	TRV00121
FDM mounting accessory (diameter 22 mm)	TRV00128

### ULP wiring accessories



Breaker ULP cord L = 0.35 m	LV434195
Breaker ULP cord L = 1.3 m	LV434196
Breaker ULP cord L = 3 m	LV434197

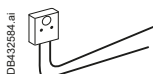

2 Modbus line terminators	VW3A8306DRC <sup>[1]</sup>
---------------------------	----------------------------



5 RJ45 connectors female/female	TRV00870
---------------------------------	----------



10 ULP line terminators	TRV00880
-------------------------	----------



10 RJ45/RJ45 male cord L = 0.3 m	TRV00803
10 RJ45/RJ45 male cord L = 0.6 m	TRV00806
5 RJ45/RJ45 male cord L = 1 m	TRV00810
5 RJ45/RJ45 male cord L = 2 m	TRV00820
5 RJ45/RJ45 male cord L = 3 m	TRV00830
1 RJ45/RJ45 male cord L = 5 m	TRV00850

[1] www.schneider-electric.com.

# ComPacT NSX100 DC to NSX250 DC Circuit Breakers

Check the applicable  and enter the appropriate square boxes information in the rectangles

Circuit breaker ComPacT type **NSX100/160/250** Quantity

Rating **A**

Circuit breaker **F, N, M, S**

Number of poles **1 or 2**

Circuit breaker **DC**

Number of poles **3 or 4**

Number of poles tripped **3d or 4d**

Fixed device Front conn.  Long rear conn.  Short rear conn.

Plug-in/withdr. Plug-in  Withdrawable

### Thermal-magnetic trip unit

**Thermal-magnetic NSX100 to 250** TMD rating (16...63 A)

TMG rating (16...250 A)

TMDC rating (80...250 A)

### Special connection accessories for parallel or series connection

**Series connection** 2 poles (1 connection plate)

3 poles (2 connection plates)

4 poles (3 connection plates)

**Parallel connection** 2 poles (2 connection plates)

3 poles (NSX100 to 250, 1 set of 2 connection plates)

2 x 2 poles (4 connection plates)

### Special terminal shields for parallel or series connection

1P short 1 pair

2P short 2 x 1 pair (1P)

3P short for series connection of poles 1 set

4P short for series connection of poles 1 set

4P short for parallel connection of poles (2P/4P) 1 set

### Connection

NSX100/250 connectors Steel 1.5° to 95° (< 160 A)

Aluminium 25° to 95° (< 250 A)

Aluminium 120° to 185° (< 250 A)

Voltage measurement For bare cable input connector NSX100/250 ≤ 185°

### Right-angle terminal extensions

Straight extensions NSX100/250

Double L terminal extension 3P  4P

Spreader from 35 to 45 mm 3P  4P

One piece spreader

Front alignment

Cu cable lugs NSX100/250 120°  150°  185°

240°  300°

Al cable lugs NSX100/250 150°  185°

240°  300°

Insulation screen 45 mm 3P  4P

70 mm 3P  4P

Interphase barriers Set of 6

### Indication and measurements

Auxiliary contact OF  SD  SDE  Standard  Low level

SDE adapter (TM trip unit)

### Remote operation

Electrical operation Motor mechanism AC  DC  V

Voltage releases Instantaneous MX AC  DC  V

MN AC  DC  V

Fixed time delay MN AC  DC  V

Adjust. time delay MN AC  DC  V

### Rotary handles

Direct Black  Red on yellow front

MCC conversion access.  CNOMO conversion access.

Extended Black  Red on yellow front

Telescopic handle for withdrawable device

Indication auxiliary 1 early-break switch  2 early-break switches

Wiring accessory for early-make switches

### Locking

Toggle (1 to 3 padlocks) Removable  Fixed Open/Close

Fixed Open

Rotary handle Keylock adapter (keylock not included)

Keylock Ronis 1351B.500  Profalux KS5 B24 D4Z

Motor mechanism Keylock adapter + Keylock Ronis (special) NSX100/250

Keylock Ronis 1351B.500  Profalux KS5 B24 D4Z

### Interlocking

Mechanical Toggle  Rotary handle

By key (2 Keylocks, 1 key) Keylock adapter (keylock not included)

For rotary handle Keylock Ronis 1351B.500  Profalux KS5 B24 D4Z

### Installation accessories

Front-panel escutcheon Toggle

Rotary handle, motor mechanism, escutcheon collar; IP40

Toggle cover

Sealing accessories

DIN rail adapter NSX100/250

### Plug-in/Drawout configuration accessories

Auxiliary connections 1 automatic connector fixed part with 9 wires (for base)

1 auto. conn. moving part with 9 wires (for circuit breaker)

1 support for 3 automatic connector moving parts

9-wire manual auxiliary connector (fixed + moving)

Plug-in base accessories Long insulated terminals Set of 3  Set of 4

2 IP4 shutters for base

Chassis accessories Escutcheon collar Toggle

Locking kit (keylock not included)

2 carriage switches (conn./disconnected position indication)

Parts of plug-in Plug-in base FC/RC 2P  3P  4P

Set of 2 power connections Standard

Safety trip for advanced opening

For 3P/4P chassis Moving part

Fixed part

### Communication

NSX Cord L = 0.35 m  NSX Cord L = 1.3 m

NSX Cord U > 480 V AC L = 0.35 m  NSX Cord L = 3 m

BSCM

Communicating motor mechanism 220-240 V

Switchboard front display module FDM121

FDM mounting accessory

Ethernet interface + gateway

Ethernet interface

Modbus interface

I/O application module Qty 1  Qty 2

Stacking accessory

ULP line termination

RJ45 connectors female/female  Wire length RJ45  Wire length RJ45

L = 0.3 m L = 0.6 m

Wire length RJ45  Wire length RJ45

L = 1 m L = 2 m

Wire length RJ45  Wire length RJ45

L = 3 m L = 5 m



# ComPacT NSX400 DC to NSX630 DC Circuit Breakers and Switch-Disconnectors

Check the applicable  and enter the appropriate   
square boxes information in the rectangles

Circuit breaker/ Switch-disconnector	Quantity	
ComPacT type	<b>NSX400/630</b>	
switch-disconnector	<input type="checkbox"/>	circuit breaker <input type="checkbox"/>
Rating	<b>A</b>	
Circuit breaker	<b>F, S</b>	
	<b>DC</b>	
Number of poles	<b>3 or 4</b>	
Fixed device	Front conn. <input type="checkbox"/>	Long rear conn. <input type="checkbox"/>
	Short rear conn. <input type="checkbox"/>	
Plug-in/withdr.	Plug-in <input type="checkbox"/>	Withdrawable <input type="checkbox"/>
Circuit breaker thermal-magnetic trip unit		
<b>Thermal-magnetic</b>	<b>TM-DC</b> rating (250...600 A)	<input type="checkbox"/>

Special connection accessories for parallel or series connection		
<b>Series connection</b>	2 poles (1 connection plate)	<input type="checkbox"/>
	3 poles (2 connection plates)	<input type="checkbox"/>
	4 poles (3 connection plates)	<input type="checkbox"/>
<b>Parallel connection</b>	2 poles (2 connection plates)	<input type="checkbox"/>
	2 x 2 poles (4 connection plates)	<input type="checkbox"/>

Special terminal shields for parallel or series connection		
Terminal shield for front connection		<input type="checkbox"/>
Terminal shield for rear connection		<input type="checkbox"/>
	Standard <input type="checkbox"/>	Short <input type="checkbox"/>

Connection		
NSX400/630 connectors	1 cable 35 <sup>2</sup> to 300 <sup>2</sup>	<input type="checkbox"/>
	2 cables 35 <sup>2</sup> to 240 <sup>2</sup>	<input type="checkbox"/>
Voltage measurement input	For bare cable connector	<input type="checkbox"/>
Right-angle terminal extensions		<input type="checkbox"/>
Edgewise extensions		<input type="checkbox"/>
Double L terminal extension	3P <input type="checkbox"/>	4P <input type="checkbox"/>
Spreader from 35 to 45 mm	3P <input type="checkbox"/>	4P <input type="checkbox"/>
One piece spreader		<input type="checkbox"/>
Front alignment		<input type="checkbox"/>
Cu cable lugs	NSX400/630 120 <sup>2</sup> <input type="checkbox"/>	150 <sup>2</sup> <input type="checkbox"/>
		185 <sup>2</sup> <input type="checkbox"/>
		240 <sup>2</sup> <input type="checkbox"/>
		300 <sup>2</sup> <input type="checkbox"/>
Al cable lugs	NSX400/630 150 <sup>2</sup> <input type="checkbox"/>	185 <sup>2</sup> <input type="checkbox"/>
		240 <sup>2</sup> <input type="checkbox"/>
		300 <sup>2</sup> <input type="checkbox"/>
Insulation screen	45 mm 3P <input type="checkbox"/>	4P <input type="checkbox"/>
	70 mm 3P <input type="checkbox"/>	4P <input type="checkbox"/>
Interphase barriers		Set of 6 <input type="checkbox"/>

Indication and measurements					
Auxiliary contact	OF <input type="checkbox"/>	SD <input type="checkbox"/>	SDE <input type="checkbox"/>	Standard <input type="checkbox"/>	Low level <input type="checkbox"/>
SDE adapter (TM trip unit)					<input type="checkbox"/>

Remote operation					
Electrical operation	Motor mechanism	AC <input type="checkbox"/>	DC <input type="checkbox"/>	V <input type="checkbox"/>	
Voltage releases	Instantaneous	MX AC <input type="checkbox"/>	DC <input type="checkbox"/>	V <input type="checkbox"/>	
		MN AC <input type="checkbox"/>	DC <input type="checkbox"/>	V <input type="checkbox"/>	
	Fixed time delay	MN AC <input type="checkbox"/>	DC <input type="checkbox"/>	V <input type="checkbox"/>	
	Adjust. time delay	MN AC <input type="checkbox"/>	DC <input type="checkbox"/>	V <input type="checkbox"/>	

Rotary handles					
Direct	Black <input type="checkbox"/>	Red on yellow front <input type="checkbox"/>			
	MCC conversion access. <input type="checkbox"/>	CNOMO conversion access. <input type="checkbox"/>			
Extended	Black <input type="checkbox"/>	Red on yellow front <input type="checkbox"/>			
	Telescopic handle for withdrawable device <input type="checkbox"/>				
Indication auxiliary	1 early-break switch <input type="checkbox"/>	2 early-break switches <input type="checkbox"/>			
	Wiring accessory for early-make switches <input type="checkbox"/>				

Locking					
Toggle (1 to 3 padlocks)	Removable <input type="checkbox"/>	Fixed Open/Close <input type="checkbox"/>			
		Fixed Open <input type="checkbox"/>			
Rotary handle	Keylock adapter (keylock not included) <input type="checkbox"/>				
	Keylock Ronis 1351B.500 <input type="checkbox"/>	Profalux KS5 B24 D4Z <input type="checkbox"/>			
Motor mechanism	Keylock adapter (keylock not included) <input type="checkbox"/>	NSX400/630 <input type="checkbox"/>			
	Keylock Ronis 1351B.500 <input type="checkbox"/>	Profalux KS5 B24 D4Z <input type="checkbox"/>			

Interlocking					
Mechanical	Toggle <input type="checkbox"/>	Rotary handle <input type="checkbox"/>			
By key (2 Keylocks, 1 key)	Keylock adapter (keylock not included) <input type="checkbox"/>				
For rotary handle	Keylock Ronis 1351B.500 <input type="checkbox"/>	Profalux KS5 B24 D4Z <input type="checkbox"/>			

Installation accessories					
Front-panel escutcheon	Toggle <input type="checkbox"/>	Rotary handle, motor mechanism, escutcheon collar; IP40 <input type="checkbox"/>			

Toggle cover		<input type="checkbox"/>			
Sealing accessories					<input type="checkbox"/>

Plug-in/Drawout configuration accessories					
Auxiliary connections	1 automatic connector fixed part with 9 wires (for base) <input type="checkbox"/>				
	1 auto. conn. moving part with 9 wires (for circuit breaker) <input type="checkbox"/>				
	1 support for 3 automatic connector moving parts <input type="checkbox"/>				
	9-wire manual auxiliary connector (fixed + moving) <input type="checkbox"/>				
Plug-in base accessories	Long insulated terminals	Set of 3 <input type="checkbox"/>	Set of 4 <input type="checkbox"/>		
	2 IP4 shutters for base <input type="checkbox"/>				
Chassis accessories	Escutcheon collar	Toggle <input type="checkbox"/>			
	Locking kit (keylock not included) <input type="checkbox"/>				
	2 carriage switches (conn./disconnected position indication) <input type="checkbox"/>				
Parts of plug-in	Plug-in base FC/RC	2P <input type="checkbox"/>	3P <input type="checkbox"/>	4P <input type="checkbox"/>	
	Set of 2 power connections	Standard <input type="checkbox"/>			
	Safety trip for advanced opening <input type="checkbox"/>				
	For 3P/4P chassis				Moving part <input type="checkbox"/>
					Fixed part <input type="checkbox"/>

Communication					
	NSX Cord L = 0.35 m <input type="checkbox"/>	NSX Cord L = 1.3 m <input type="checkbox"/>			
	NSX Cord U > 480 V AC L = 0.35 m <input type="checkbox"/>	NSX Cord L = 3 m <input type="checkbox"/>			

BSCM					
Communicating motor mechanism 220-240 V					
Switchboard front display module FDM121					
FDM mounting accessory					
Ethernet interface + gateway					
Ethernet interface					
Modbus interface					
I/O application module		Qty 1 <input type="checkbox"/>		Qty 2 <input type="checkbox"/>	
Stacking accessory					
ULP line termination					
RJ45 connectors female/female	<input type="checkbox"/>	Wire length RJ45 L = 0.3 m <input type="checkbox"/>	Wire length RJ45 L = 0.6 m <input type="checkbox"/>		
		Wire length RJ45 L = 1 m <input type="checkbox"/>	Wire length RJ45 L = 2 m <input type="checkbox"/>		
		Wire length RJ45 L = 3 m <input type="checkbox"/>	Wire length RJ45 L = 5 m <input type="checkbox"/>		



# ComPacT NSX1200 DC Circuit Breakers

Check the applicable  and enter the appropriate square boxes information in the rectangles

Circuit breaker Rating **630A, 800 A, 1000 A, 1200 A** Quantity

Fixed device Without bare cable connector   
With bare cable connector

Connection Voltage measurement input For bare cable connector

Indication auxiliaries Auxiliary contact OF  SD  SDE  Standard  Low level

SDE adapter (TM trip unit)

Remote operation Electrical operation Motor mechanism AC  DC  V   
Voltage releases Instantaneous MX AC  DC  V   
MN AC  DC  V   
Fixed time delay MN AC  DC  V   
Adjust. time delay MN AC  DC  V

Rotary handles Direct Black  Red on yellow front   
MCC conversion access.  CNOMO conversion access.   
Extended Black  Red on yellow front   
Telescopic handle for withdrawable device   
Indication auxiliary 1 early-break switch  2 early-break switches   
Wiring accessory for early-make switches

Locking Toggle (1 to 3 padlocks) Removable  Fixed Open/Close   
Fixed Open

Rotary handle Keylock adapter (keylock not included)   
Keylock Ronis 1351B.500  Profalux KS5 B24 D4Z   
Motor mechanism Keylock adapter (keylock not included)  NSX400/630   
Keylock Ronis 1351B.500  Profalux KS5 B24 D4Z

Interlocking Mechanical Toggle  Rotary handle   
By key (2 Keylocks, 1 key) Keylock adapter (keylock not included)   
For rotary handle Keylock Ronis 1351B.500  Profalux KS5 B24 D4Z

Installation accessories Front-panel escutcheon Toggle   
Rotary handle, motor mechanism, escutcheon collar; IP40

Toggle cover   
Sealing accessories

Communication NSX Cord L = 0.35 m  NSX Cord L = 1.3 m   
NSX Cord U > 480 V AC L = 0.35 m  NSX Cord L = 3 m

BSCM Communicating motor mechanism 220-240 V   
Switchboard front display module FDM121

FDM mounting accessory   
Ethernet interface + gateway

Ethernet interface   
Modbus interface   
I/O application module Qty 1  Qty 2

Stacking accessory   
ULP line termination   
RJ45 connectors female/female  Wire length RJ45 L = 0.3 m  Wire length RJ45 L = 0.6 m   
Wire length RJ45 L = 1 m  Wire length RJ45 L = 2 m   
Wire length RJ45 L = 3 m  Wire length RJ45 L = 5 m





# ComPacT NSX80/500 TM DC PV to NSX100/500 NA DC PV Circuit Breakers and Switch-Disconnectors

Check the applicable  and enter the appropriate square boxes information in the rectangles

Circuit breaker ComPacT	Quantity
NSX250-100 TM DC EP	NSX80 TM DC PV
NSX250-125 TM DC EP	NSX125 TM DC PV
NSX250-160 TM DC EP	NSX160 TM DC PV
NSX250-200 TM DC EP	NSX200 TM DC PV
NSX250-250 TM DC EP	NSX250 TM DC PV
NSX500-250 TM DC EP	NSX320 TM DC PV
NSX500-320 TM DC EP	NSX400 TM DC PV
NSX500-400 TM DC EP	NSX500 TM DC PV
NSX500-500 TM DC EP	

### Special connection and insulation accessories for circuit breakers (mandatory)

<b>Upstream</b>	connection plates with heatsink (x2)	
	special terminal shields	
<b>Downstream</b>	standard long terminal shields	
	or rear connections	short
		long
	+ short terminal shields	

Switch-disconnector ComPacT	Quantity
NSX250-100 NA DC EP	NSX100 NA DC PV
NSX250-160 NA DC EP	NSX160 NA DC PV
NSX250-200 NA DC EP	NSX200 NA DC PV
NSX250-250 NA DC EP	(160 A)
NSX630-320 NA DC EP	NSX200 NA DC PV
NSX630-400 NA DC EP	(200 A)
NSX630-500 NA DC EP	NSX400 NA DC PV
NSX630-630 NA DC EP	NSX500 NA DC PV

### Special connection and insulation accessories for switch-disconnectors (mandatory)

<b>Upstream</b>	connection plates with heatsink (x2)	
<b>≤ 200 A at 40 °C</b>	special terminal shields	
	or interphase barriers	
<b>Upstream</b>	connection plates with heatsink (x2)	
<b>= 200 A at 55 °C</b>	(long)	
	interphase barriers	
<b>Upstream</b>	connection plates with heatsink (x2)	
<b>≥ 400 A</b>	special terminal shields	
	or interphase barriers	
<b>Downstream</b>	standard long terminal shields	
	or rear connections	short
		long
	+ short terminal shields	
	or interphase barriers	

### Connection

NSX100/250 connectors	Steel 1.5° to 95° (< 160 A)	
	Aluminium 25° to 95° (< 250 A)	
	Aluminium 120° to 185° (< 250 A)	
NSX400/630 connectors	1 cable 35° to 300°	
	2 cables 35° to 240°	
Voltage measurement input	For bare cable connector	NSX100/250 ≤ 185°
	For bare cable connector	NSX400/630

<b>Right-angle terminal extensions</b>			
Straight extensions	NSX100/250		
Edgewise extensions	NSX400/630		
Double L terminal extension		3P	4P
Spreader from 35 to 45 mm		3P	4P
Cu cable lugs	NSX100/250	120°	150°
			185°
Al cable lugs	NSX400/630	240°	300°
	NSX100/250	150°	185°
Insulation screen	NSX400/630	240°	300°
		45 mm	3P
		70 mm	3P
Interphase barriers			Set of 6

### Indication auxiliaries

Auxiliary contact OF  SD  SDE  Standard  Low level

SDE adapter (TM trip unit)

### Remote operation

Electrical operation	Motor mechanism	AC	DC	V
Voltage releases	Instantaneous	MX	AC	DC
		MN	AC	DC
	Fixed time delay	MN	AC	DC
Adjust. time delay	MN	AC	DC	V

### Rotary handles

Direct	Black	<input type="checkbox"/>	Red on yellow front	<input type="checkbox"/>
	MCC conversion access.	<input type="checkbox"/>	CNOMO conversion access.	<input type="checkbox"/>
Extended	Black	<input type="checkbox"/>	Red on yellow front	<input type="checkbox"/>
	Telescopic handle for withdrawable device			
Indication auxiliary	1 early-break switch	<input type="checkbox"/>	2 early-break switches	<input type="checkbox"/>
	Wiring accessory for early-make switches			

### Locking

Toggle (1 to 3 padlocks)	Removable	<input type="checkbox"/>	Fixed Open/Close	<input type="checkbox"/>
			Fixed Open	<input type="checkbox"/>
Rotary handle	Keylock adapter (keylock not included)			
	Keylock Ronis 1351B.500	<input type="checkbox"/>	Profalux KS5 B24 D4Z	<input type="checkbox"/>
Motor mechanism	Keylock adapter + Keylock Ronis (special)		NSX100/250	
	Keylock adapter (keylock not included)		NSX400/630	
	Keylock Ronis 1351B.500	<input type="checkbox"/>	Profalux KS5 B24 D4Z	<input type="checkbox"/>

### Interlocking

Mechanical	Toggle	<input type="checkbox"/>	Rotary handle	<input type="checkbox"/>
By key (2 keylocks, 1 key)	Keylock adapter (keylock not included)			
For rotary handle	Keylock Ronis 1351B.500	<input type="checkbox"/>	Profalux KS5 B24 D4Z	<input type="checkbox"/>

### Installation accessories

Front-panel escutcheon	Toggle	<input type="checkbox"/>
	Rotary handle, motor mechanism, escutcheon collar; IP40	<input type="checkbox"/>
Toggle cover		<input type="checkbox"/>
Sealing accessories		<input type="checkbox"/>
DIN rail adapter	NSX100/250	<input type="checkbox"/>

### Communication

NSX Cord L = 0.35 m	<input type="checkbox"/>	NSX Cord L = 1.3 m	<input type="checkbox"/>
	NSX Cord U > 480 V AC L = 0.35 m	<input type="checkbox"/>	NSX Cord L = 3 m

### BSCM

Communicating motor mechanism 220-240 V	<input type="checkbox"/>			
Switchboard front display module FDM121	<input type="checkbox"/>			
FDM mounting accessory	<input type="checkbox"/>			
Ethernet interface + gateway	<input type="checkbox"/>			
Ethernet interface	<input type="checkbox"/>			
Modbus interface	<input type="checkbox"/>			
I/O application module	Qty 1 <input type="checkbox"/> Qty 2 <input type="checkbox"/>			
Stacking accessory	<input type="checkbox"/>			
ULP line termination	<input type="checkbox"/>			
RJ45 connectors female/female	Wire length RJ45 L = 0.3 m	<input type="checkbox"/>	Wire length RJ45 L = 0.6 m	<input type="checkbox"/>
	Wire length RJ45 L = 1 m	<input type="checkbox"/>	Wire length RJ45 L = 2 m	<input type="checkbox"/>
	Wire length RJ45 L = 3 m	<input type="checkbox"/>	Wire length RJ45 L = 5 m	<input type="checkbox"/>



# ComPacT NSX250/500 TM DC EP to NSX250/630 NA DC EP Circuit Breakers and Switch-Disconnectors

Check the applicable  and enter the appropriate square boxes information in the rectangles

Circuit breaker	Quantity
ComPacT type	
NSX250-100 TM DC EP	
NSX250-125 TM DC EP	
NSX250-160 TM DC EP	
NSX250-200 TM DC EP	
NSX250-250 TM DC EP	
NSX500-250 TM DC EP	
NSX500-320 TM DC EP	
NSX500-400 TM DC EP	
NSX500-500 TM DC EP	

### Special connection and insulation accessories for circuit breakers (mandatory)

<b>Upstream</b>	connection plates with heatsink (x2)	
	special terminal shields	
<b>Downstream</b>	standard long terminal shields	
	or rear connections short	
	long	
	+ short terminal shields	

Switch-disconnector	Quantity
ComPacT type	
NSX250-100 NA DC EP	
NSX250-160 NA DC EP	
NSX250-200 NA DC EP	
NSX250-250 NA DC EP	
NSX630-320 NA DC EP	
NSX630-400 NA DC EP	
NSX630-500 NA DC EP	
NSX630-630 NA DC EP	

### Special connection and insulation accessories for switch-disconnectors (mandatory)

<b>Upstream</b>	connection plates with heatsink (x2)	
≤ 200 A at 40 °C	special terminal shields	
	or interphase barriers	
<b>Upstream</b>	connection plates with heatsink (x2)	
= 200 A at 55 °C	(long)	
	interphase barriers	
<b>Upstream</b>	connection plates with heatsink (x2)	
≥ 400 A	special terminal shields	
	or interphase barriers	
<b>Downstream</b>	standard long terminal shields	
	or rear connections short	
	long	
	+ short terminal shields	
	or interphase barriers	

Connection	
NSX100/250 connectors	Steel 1.5° to 95° (< 160 A)
	Aluminium 25° to 95° (< 250 A)
	Aluminium 120° to 185° (< 250 A)
NSX400/630 connectors	1 cable 35° to 300°
	2 cables 35° to 240°
Voltage measurement input	For bare cable connector NSX100/250 ≤ 185°
	For bare cable connector NSX400/630

Right-angle terminal extensions	
Straight extensions	NSX100/250
Edgewise extensions	NSX400/630
Double L terminal extension	3P 4P
Spreader from 35 to 45 mm	3P 4P
Cu cable lugs	NSX100/250 120° 150° 185°
	NSX400/630 240° 300°
Al cable lugs	NSX100/250 150° 185°
	NSX400/630 240° 300°
Insulation screen	45 mm 3P 4P
	70 mm 3P 4P
Interphase barriers	Set of 6

Indication auxiliaries	
Auxiliary contact	OF <input type="checkbox"/> SD <input type="checkbox"/> SDE <input type="checkbox"/> Standard <input type="checkbox"/> Low level <input type="checkbox"/>
SDE adapter (TM trip unit)	

Remote operation	
Electrical operation	Motor mechanism AC <input type="checkbox"/> DC <input type="checkbox"/> V <input type="checkbox"/>
Voltage releases	Instantaneous MX AC <input type="checkbox"/> DC <input type="checkbox"/> V <input type="checkbox"/>
	MN AC <input type="checkbox"/> DC <input type="checkbox"/> V <input type="checkbox"/>
	Fixed time delay MN AC <input type="checkbox"/> DC <input type="checkbox"/> V <input type="checkbox"/>
	Adjust. time delay MN AC <input type="checkbox"/> DC <input type="checkbox"/> V <input type="checkbox"/>

Rotary handles	
Direct	Black <input type="checkbox"/> Red on yellow front <input type="checkbox"/>
	MCC conversion access. <input type="checkbox"/> CNOMO conversion access. <input type="checkbox"/>
Extended	Black <input type="checkbox"/> Red on yellow front <input type="checkbox"/>
	Telescopic handle for withdrawable device <input type="checkbox"/>
Indication auxiliary	1 early-break switch <input type="checkbox"/> 2 early-break switches <input type="checkbox"/>
	Wiring accessory for early-make switches <input type="checkbox"/>

Locking	
Toggle (1 to 3 padlocks)	Removable <input type="checkbox"/> Fixed Open/Close <input type="checkbox"/>
	Fixed Open <input type="checkbox"/>
Rotary handle	Keylock adapter (keylock not included) <input type="checkbox"/>
	Keylock Ronis 1351B.500 <input type="checkbox"/> Profalux KS5 B24 D4Z <input type="checkbox"/>
Motor mechanism	Keylock adapter + Keylock Ronis (special) NSX100/250 <input type="checkbox"/>
	Keylock adapter (keylock not included) NSX400/630 <input type="checkbox"/>
	Keylock Ronis 1351B.500 <input type="checkbox"/> Profalux KS5 B24 D4Z <input type="checkbox"/>

Interlocking	
Mechanical	Toggle <input type="checkbox"/> Rotary handle <input type="checkbox"/>
By key (2 keylocks, 1 key)	Keylock adapter (keylock not included) <input type="checkbox"/>
For rotary handle	Keylock Ronis 1351B.500 <input type="checkbox"/> Profalux KS5 B24 D4Z <input type="checkbox"/>

Installation accessories	
Front-panel escutcheon	Toggle <input type="checkbox"/>
	Rotary handle, motor mechanism, escutcheon collar; IP40 <input type="checkbox"/>
Toggle cover	
Sealing accessories	
DIN rail adapter	NSX100/250 <input type="checkbox"/>

Communication	
	NSX Cord L = 0.35 m <input type="checkbox"/> NSX Cord L = 1.3 m <input type="checkbox"/>
	NSX Cord U > 480 V AC L = 0.35 m <input type="checkbox"/> NSX Cord L = 3 m <input type="checkbox"/>

BSCM	
Communicating motor mechanism 220-240 V	
Switchboard front display module FDM121	
FDM mounting accessory	
Ethernet interface + gateway	
Ethernet interface	
Modbus interface	
I/O application module	Qty 1 <input type="checkbox"/> Qty 2 <input type="checkbox"/>
Stacking accessory	
ULP line termination	
RJ45 connectors female/female	<input type="checkbox"/> Wire length RJ45 L = 0.3 m <input type="checkbox"/> Wire length RJ45 L = 0.6 m <input type="checkbox"/>
	Wire length RJ45 L = 1 m <input type="checkbox"/> Wire length RJ45 L = 2 m <input type="checkbox"/>
	Wire length RJ45 L = 3 m <input type="checkbox"/> Wire length RJ45 L = 5 m <input type="checkbox"/>

# ComPacT NSX630/1600 NA DC PV 4P, Fixed Version

## Upside: Front Connection, 2 Kit Heatsink, Phase Separator Are Included

Name of customer: .....  
 Address for delivery: .....  
 Requested delivery date: .....  
 Customer order no: .....

To indicate your choices,  
 Check the applicable square  and enter the appropriate information in the boxes

Switch-disconnector  Quantity   
 Rating  A

Communication

COM module Device  with Ethernet interface   
 (BCM-ULP)  with Ethernet interface + gateway   
 with Modbus interface

Front Display Module (FDM121)  Mounting accessory

Breaker ULP Cord L = 0.35 m   
 L = 1.3 m   
 L = 3 m

AD - external power-supply module  V

NSX630b/1600 DC PV connection

Horizontal rear connections Bottom   
 Vertical rear connections Bottom   
 Front connections Bottom   
 4 x 240° + bare cable connectors + shields Bottom   
 Vertical-connection adapters Bottom   
 Cable-lug adapters Bottom   
 Long connection shields <sup>[1]</sup> Top  Bottom   
 or interphase barriers Bottom

[1] Bottom long connection shield or Bottom interphase barriers kit is mandatory.

### Indication contacts

OF - ON/OFF indication contacts (maximum 3)  
 6 A-240 V AC qty  Low level qty

### Remote operation

Electrical operation (NSX 630b/1600 DC PV)	Standard	<input type="checkbox"/>	Communicating	<input type="checkbox"/>
Power supply	AC	<input type="checkbox"/>	DC	<input type="checkbox"/>
Voltage releases	MX	AC	DC	<input type="checkbox"/>
	MN	AC	DC	<input type="checkbox"/>
MN delay unit	Adjustable	<input type="checkbox"/>	Non-adjustable	<input type="checkbox"/>

### Locking

For electrically operated devices (NSX630b/1600 DC PV)

VBP - ON/OFF pushbutton locking (by transparent cover + padlocks)

OFF position locking:

VCPO - by padlocks

VSPO - by keylocks:

Keylock kit (w/o keylock)	Profalux	<input type="checkbox"/>	Ronis	<input type="checkbox"/>
1 keylock	Profalux	<input type="checkbox"/>	Ronis	<input type="checkbox"/>
2 identical keylocks, 1 key	Profalux	<input type="checkbox"/>	Ronis	<input type="checkbox"/>

### Accessories

CDM - mechanical operation counter

CDP - escutcheon

CP - transparent cover for escutcheon

OP - blanking plate for escutcheon



# MasterPact NW DC

Name of customer: .....  
 Address for delivery: .....  
 Requested delivery date: .....  
 Customer order no.: .....

To indicate your choices, check the applicable square boxes  
 and enter the appropriate information in the rectangles

Circuit breaker or switch-disconnector		
Qty		
MasterPact type	<b>NW10</b>	
	<b>NW20</b>	
	<b>NW40</b>	
Circuit breaker	<b>N, H (up to 900 V DC), EPDC (1000 V DC)</b>	
Special PV switch-disconnectors	<b>HADCD-PV (NW20 or NW40 1000 V DC)</b>	
	<b>HADCD-PV2 (NW32-1500 V DC FIXED)</b>	
Switch-disconnector	<b>HA</b>	
Sensor version	<b>1250 to 2500 A</b>	
	<b>2500 to 5400 A</b>	
	<b>5000 to 11000 A</b>	
Version	<b>C, D, E</b>	
Type of equipment	Fixed	
	Drawout chassis	

Communication	
<b>COM module</b>	
Device (BCM-ULP)	<input type="checkbox"/> with Ethernet interface <input type="checkbox"/> Cradle management with I/O application module (Chassis)
	<input type="checkbox"/> with Ethernet interface + gateway <input type="checkbox"/> with Modbus interface

Front Display Module FDM121		Mounting accessory
Breaker ULP Cord	L = 0.35	
	L = 1.3	
	L = 3 m	

Connection	
<b>Vertical</b>	Standard version    Top <input checked="" type="checkbox"/> Bottom <input checked="" type="checkbox"/>
<b>Horizontal</b>	Vertical connection is standard however the connectors can be rotated on-site conversion to horizontal connection (except on the NW40)

### Indication contacts

#### OF - ON/OFF indication contacts

Standard	4 OF 10 A/240 V AC and low level		
Additional	1 block of 4 OF	Max. 2	Qty <input type="text"/>

#### EF - combined "connected/closed" contacts

	1 EF 6 A/240 V AC	Max. 8	Qty <input type="text"/>
	1 EF low level	Max. 8	Qty <input type="text"/>

#### SDE - "fault-trip" indication contact

Standard	1 SDE 6 A/240 V AC		
Additional	1 SDE 6 A/240 V AC	1 SDE low level	

#### Carriage switches

Low level		6 A/240 V AC	
CE - "connected" position	Max. 3		Qty <input type="text"/>

#### CD - "disconnected" position

Max. 3			Qty <input type="text"/>
--------	--	--	--------------------------

#### CT - "test" position

Max. 3			Qty <input type="text"/>
--------	--	--	--------------------------

#### AC - NW actuator for 6 CE - 3 CD - 0 CT additional carriage switches

			Qty <input type="text"/>
--	--	--	--------------------------

### Remote operation

#### Electrical operation

<b>MCH</b> - gear motor		V	<input type="text"/>
<b>XF</b> - closing voltage release		V	<input type="text"/>
<b>MX</b> - opening voltage release		V	<input type="text"/>
<b>PF</b> - "ready to close" contact	Low level		<input type="text"/>
	6 A/240 V AC		<input type="text"/>
<b>BPFE</b> - electrical closing pushbutton			<input type="text"/>
<b>RES</b> - electrical reset option		V	<input type="text"/>
<b>RAR</b> - automatic reset option			<input type="text"/>

#### Remote tripping

<b>MN</b> - undervoltage release		V	<input type="text"/>
<b>R</b> - delay unit (non-adjustable)			<input type="text"/>
<b>Rr</b> - adjustable delay unit			<input type="text"/>
<b>2° MX</b> - shunt release		V	<input type="text"/>

### Locking

#### VBP - ON/OFF pushbutton locking (by transparent cover + padlocks)

#### OFF position locking:

<b>VCPO</b> - by padlocks			
<b>VSP0</b> - by keylocks	Keylock kit (w/o keylock)	Profalux	<input type="text"/>
	1 keylock	Profalux	<input type="text"/>
	2 identical keylocks, 1 key	Profalux	<input type="text"/>
	2 keylocks, different keys	Profalux	<input type="text"/>

#### Chassis locking in "disconnected" position:

<b>VSPD</b> - by keylocks	Keylock kit (w/o keylock)	Profalux	<input type="text"/>	Ronis	<input type="text"/>
		Kirk	<input type="text"/>	Castell	<input type="text"/>
	1 keylock	Profalux	<input type="text"/>	Ronis	<input type="text"/>
	2 identical keylocks, 1 key	Profalux	<input type="text"/>	Ronis	<input type="text"/>
	2 keylocks, different keys	Profalux	<input type="text"/>	Ronis	<input type="text"/>

<b>VPEC</b> - door interlock	On right-hand side of chassis	<input type="text"/>
	On left-hand side of chassis	<input type="text"/>

#### VPOC - racking interlock

#### IPA - cable-type door interlock

#### VDC - mismatch protection

#### VIVC - shutter position indication and locking

#### IBPO - racking interlock between crank and OFF pushbutton for NW

#### DAE - automatic spring discharge before breaker removal for NW

### Accessories

<b>VO</b> - safety shutters on chassis	<input type="text"/>
<b>GDM</b> - mechanical operation counter	<input type="text"/>
<b>CB</b> - auxiliary terminal shield for chassis	<input type="text"/>
<b>CDP</b> - escutcheon	<input type="text"/>
<b>CP</b> - transparent cover for escutcheon	<input type="text"/>
<b>OP</b> - blanking plate for escutcheon	<input type="text"/>
<b>KMT</b> - Grounding kit	<input type="text"/>

F





# Green Premium™



More than 75% of our product sales offer superior transparency on the material content, regulatory information and environmental impact of our products:

- RoHS compliance
- REACH substance information
- Industry leading # of PEP's\*
- Circularity instructions



Discover what we mean by green  
**Check your products!**

The Green Premium program stands for our commitment to deliver customer valued sustainable performance. It has been upgraded with recognized environmental claims and extended to cover all offers including Products, Services and Solutions.

#### CO<sub>2</sub> and P&L impact through... Resource Performance

Green Premium brings improved resource efficiency throughout an asset's lifecycle. This includes efficient use of energy and natural resources, along with the minimization of CO<sub>2</sub> emissions.

#### Cost of ownership optimization through... Circular Performance

We're helping our customers optimize the total cost of ownership of their assets. To do this, we provide IoT-enabled solutions, as well as upgrade, repair, retrofit, and remanufacture services.

#### Peace of mind through... Well-being Performance

Green Premium products are RoHS and REACH compliant. We're going beyond regulatory compliance with step-by-step substitution of certain materials and substances from our products.

#### Improved sales through... Differentiation

Green Premium delivers strong value propositions through third-party labels and services. By collaborating with third-party organizations we can support our customers in meeting their sustainability goals such as green building certifications.

\*PEP: Product Environmental Profile (i.e. Environmental Product Declaration)

Life Is On | **Schneider**  
Electric

**Schneider Electric Industries SAS**

35, rue Joseph Monier  
CS 30323  
92506 Rueil Malmaison Cedex  
France

RCS Nanterre 954 503 439  
Capital social 928 298 512 €  
[www.se.com](http://www.se.com)

02/2024

© 2024 - Schneider Electric. All Rights Reserved.

All trademarks are owned by Schneider Electric Industries SAS or its affiliated companies.

Document reference: LVPED221002EN