

Datasheet

RS Pro HSS Counterbores

RS Stock No: 131-993

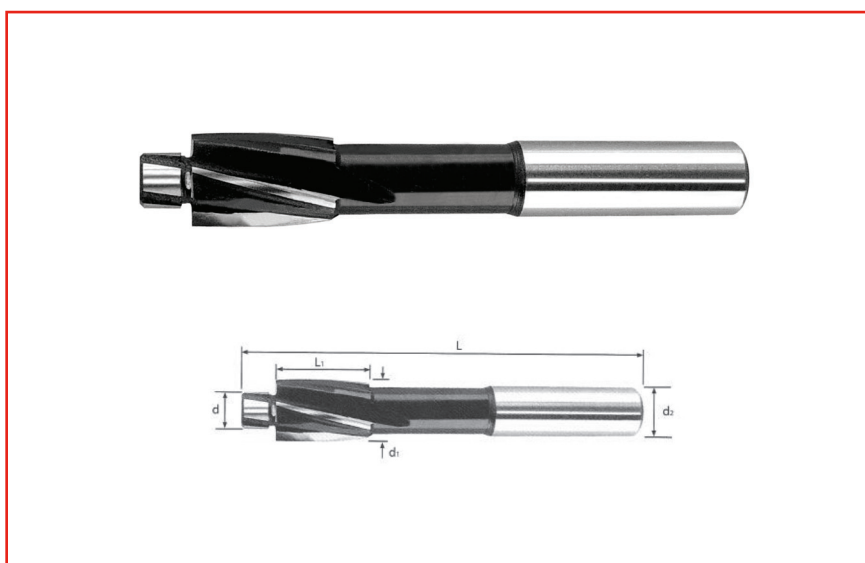

Specifications:

4 Flute Straight Shank Counterbores

Used to produce recessed holes for cap head screws

Material: High Speed Steel

DIN 373

Screw Size	d1 (mm)	d2 (mm)	d (mm)	L	L1
M10	18	12.5	11.0	100	22

Order Code	Manufacturers Code	Description
131-993	28-650-010	HSS Counterbore M10