

For standby power supplies
 Expected trickle life: 6 years at 25°C
 10 years at 20°C

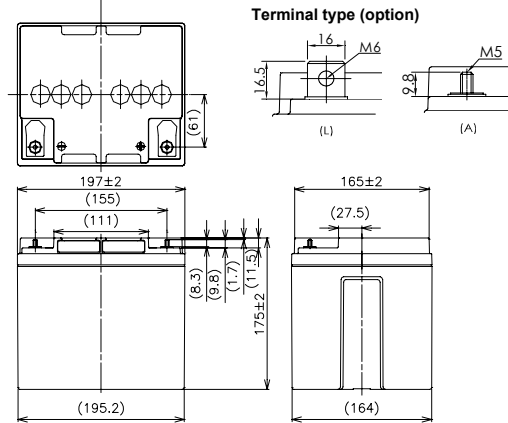

※Contents indicated (including the recycle marking, etc) are subject to change without notice.

■Dimensions(mm)



Battery case resin: Flame-retardant (UL94V-0)

■Specification

Nominal Voltage		12V
Rated Capacity(20HR)		38Ah
Dimensions	Length	197 mm
	Width	165 mm
	Height	175 mm
	Total height	175 mm/180mm
Approx. Mass		12.5 kg
Terminal		M5 & M6 threaded post

■Characteristics

Capacity (25 °C)	20 hour rate	38Ah
	10 hour rate	36Ah
	3 hour rate	29Ah
	1 hour rate	22Ah
Internal Resistance (25 °C)	Fully charged battery	10 mΩ
Temperature Dependency of Capacity (20 hour rate)	40 °C	102%
	25 °C	100%
	0 °C	85%
	-15 °C	65%
Self Discharge (25 °C)	After 3 months	91%
	After 6 months	82%
	After 12 months	64%

■Duration of discharge vs. discharge current

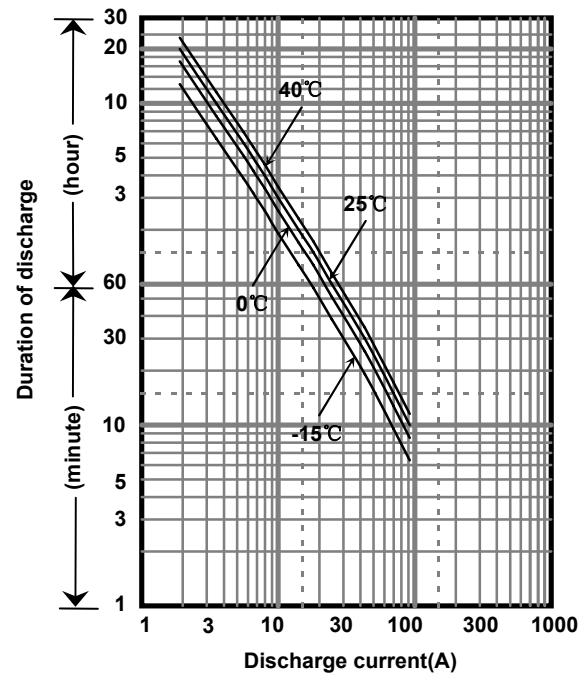

■Watt Table(25°C)

Cut-off V	(Wattage/Battery)														
	5min	10min	15min	20min	30min	45min	1h	1.5h	2h	3h	4h	5h	6h	10h	20h
9.6V	1349	1030	800	686	505	351	276	214	169	123	99.2	77.9	68.3	42.0	22.8
9.9V	1271	1008	788	682	500	350	269	209	168	120	98.0	76.7	68.0	42.0	22.8
10.2V	1204	980	768	672	489	349	267	185	167	119	96.8	75.5	67.7	42.0	22.8
10.5V	1126	952	748	661	480	346	265	183	166	117	95.6	74.9	67.4	42.0	22.8
10.8V	1098	874	716	640	468	308	247	175	155	114	94.4	74.3	67.1	42.0	22.8

■Ampere Table(25°C)

Cut-off V	(Ampere/Battery)														
	5min	10min	15min	20min	30min	45min	1h	1.5h	2h	3h	4h	5h	6h	10h	20h
9.6V	121	92.0	69.6	59.1	43.2	29.9	23.4	18.1	14.3	10.3	8.30	6.50	5.70	3.60	1.90
9.9V	114	90.0	68.5	58.8	42.7	29.8	22.8	17.7	14.2	10.1	8.20	6.40	5.68	3.60	1.90
10.2V	108	87.5	66.8	57.9	41.8	29.7	22.7	15.7	14.1	10.0	8.10	6.30	5.66	3.60	1.90
10.5V	101	85.0	65.0	57.0	41.0	29.5	22.5	15.5	14.0	9.80	8.00	6.25	5.64	3.60	1.90
10.8V	98.5	78.0	62.3	55.2	40.0	26.2	21.0	14.8	13.1	9.60	7.90	6.20	5.60	3.60	1.90

Charging Method (25°C)

Trickle use	Control voltage:13.6-13.8V Initial current:5.70A or smaller
-------------	--

Cut off voltage

Discharge current	1.90A-7.60A	7.60A-19.0A	19.0A-38.0A	38.0A-76.0A	76.0A-114A
Cut off voltage(V)	10.5	10.2	9.9	9.3	8.7

Influence of Temperature on Trickle life

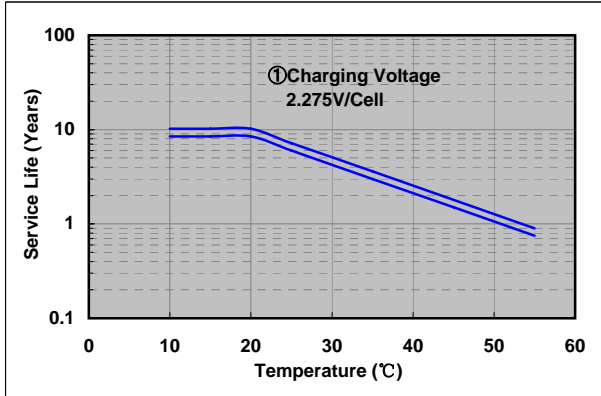

Residual capacity test result

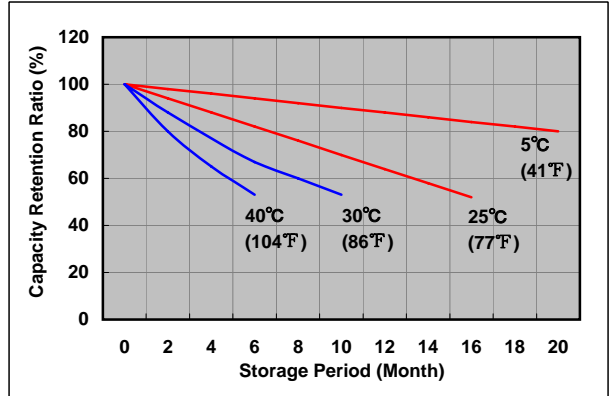

Constant-voltage constant-current charge characteristics for Trickle use

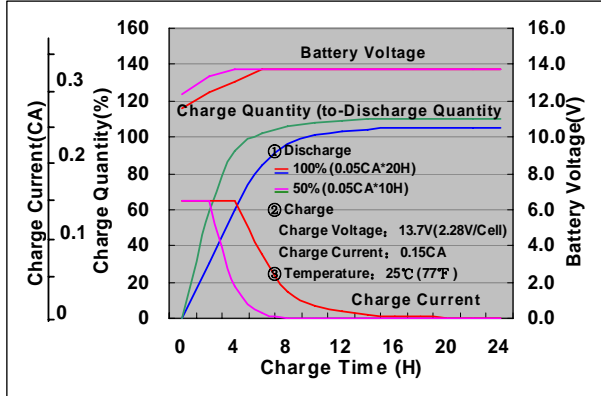

Discharge capacity by temperature and by discharge current

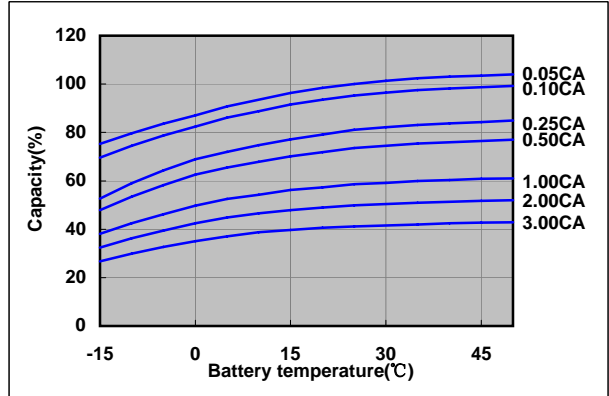

Discharge characteristics(25°C)

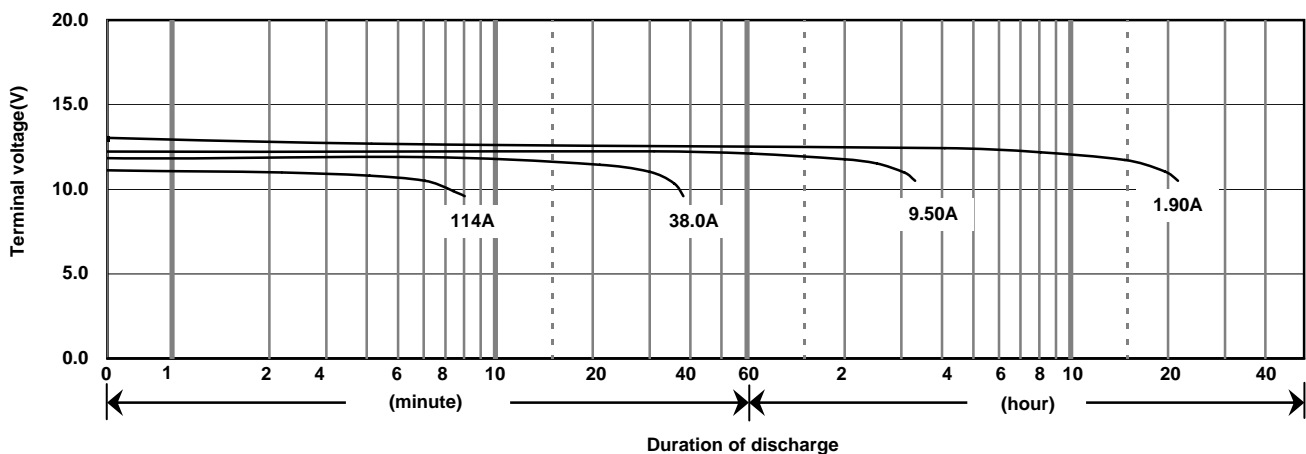

Caution

Due to the potential energy stored in the batteries, Please read 《Precautions for handling the Rechargeable Valve Regulated Lead Acid Batteries》 before using batteries. If improper handling or use of the batteries without understanding 《Precautions for handling the Rechargeable Valve Regulated Lead Acid Batteries》 may result in bodily injury caused by electrolyte leakage, heat generation, or explosion.

Panasonic Storage Battery (Shenyang) Co., Ltd

NO. 51 Kunminghu Street, Shenyang Economic & Technical Development Zone, 110141 China

Tel: 86 24 25818921

Fax: 86 24 62786318

Website: <http://www.panasonicbattery.cn>

2010.03