

Datasheet

RS PRO 5.0mm Pitch, 5 Ways, Stright Euro block Header, Hook on Entry Side

Stock No: 2378437, 2378438



Product Details:

RS PRO Series Euro Blocks are a broad range of PCB mounted terminal blocks in various sizes and profiles with pitches ranging from 15.00mm down to 3.50mm. Included are types that have wire entry from Top, Side or Side Angle. Two piece 'pluggable' versions and 'Lever Actuated' styles are also available. Each contains our unique wire guard design and is precision manufactured for smooth operation and ease of use.

Features & Benefits:

- Industry standard compatibility
- Dove tail design allows building multi-positions
- Captive screw with rising clamp design
- Euro blocks are supplied open screw "wire ready" position which shortens the time for connection.
- Available in many centerline pitch spacing.
- Available with optional high temperature insulator.
- Different color options available.

SPECIFICATION:

Material:

Insulator: PA66, rated UL 94V-0

Insulator color: Green

Screws: M3, Steel, Zinc plated

Clamp: Phosphor Bronze, Nickel plated

Cage: Brass, Nickel plated

Electrical:

Voltage rated: 300V

Current rating: 15A

Contact resistance: 20 mohms

Insulation resistance: 500 Mohms @ 500 VDC

Dielectric withstanding voltage: 2,000 VAC for 1 minute

Mechanical:

Wire range: 28-14AWG, 1.5mm²

Torque: 0.5Nm, 4.5Lb-in

Wire strip length: 7-8mm

Temperature Rating:

-40°C to +105°C

Environmental:

Dimensional line drawings

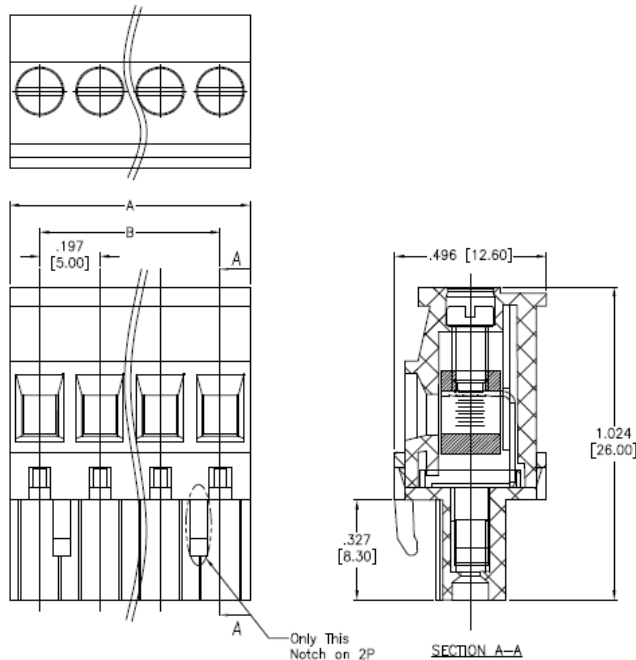

Positions: 02 thru 24
A = .197 [5.00] x No. of Positions
B = .197 [5.00] x No. of Spaces



rspro.com

