

Data sheet

SENSOR BAYONET BASE

ENGLISH

RS Stock No. 324-2184

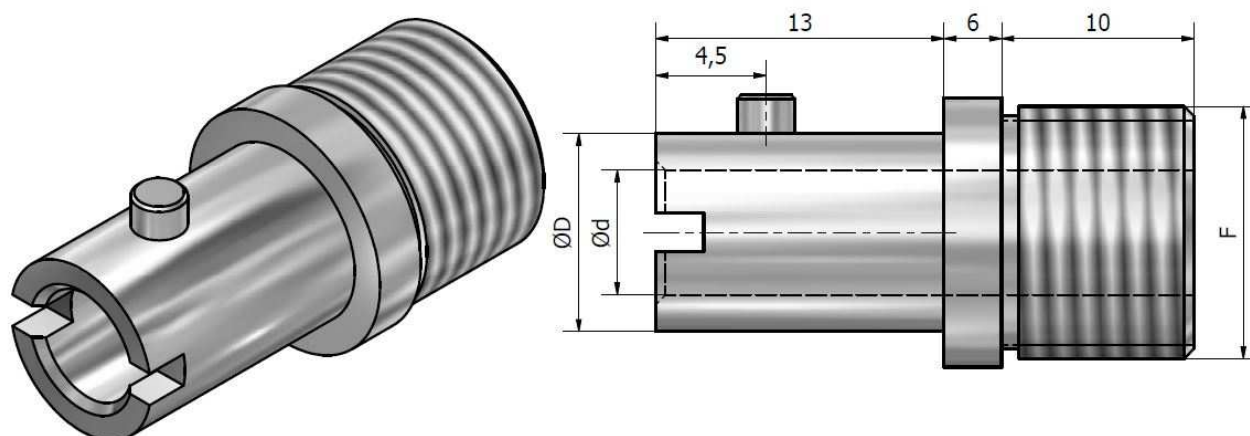

SENSOR BAYONET BASE

USE : Plastic factory

MATERIAL : Nickel plated brass

Lock type possible :

- A = $\varnothing 10.5 \times 14$ mm
- B = $\varnothing 12.3 \times 14.5$ mm
- C = $\varnothing 12.5 \times 18$ mm
- D = $\varnothing 14.5 \times 18$ mm
- E = $\varnothing 15 \times 18$ mm
- F = $\varnothing 10.6 \times 14$ mm

Characteristics :	C6	L6	L8	D8
$\varnothing D$ (mm)	10.3	12	12	14.2
$\varnothing d$ (mm)	5-6	5-6	8	8
For lock type :	A-F	B-C-G	B-C-G	D-E

Other Dimensions :

Thread F	C6	L6	L8	D8
M10 X 100	324-2099	324-2184		
M10 X 150	324-2106	324-2190		
M12 X 100	324-2128	324-2207	324-2314	
M12 X 175	324-2134	324-2213	324-2320	324-2364
M14 X 150	324-2140	324-2229	324-2342	
1/4" GCY	324-2162	324-2241		324-2386
1/8" NPT	324-2178			