



Datasheet

RS PRO 2m 6.35mm Stereo Jack Cable, Black with Nickel Connectors

Stock number: 192-4467

EN

The RS PRO 2 metre, 6.35mm stereo jack cable has a black PVC jack and nickel metal boots.

The connectors are nickel and have a spring strain relief to help avoid the cable splitting around the edge of the boot.

The 3.5mm jack plug is used on a variety of audio devices.

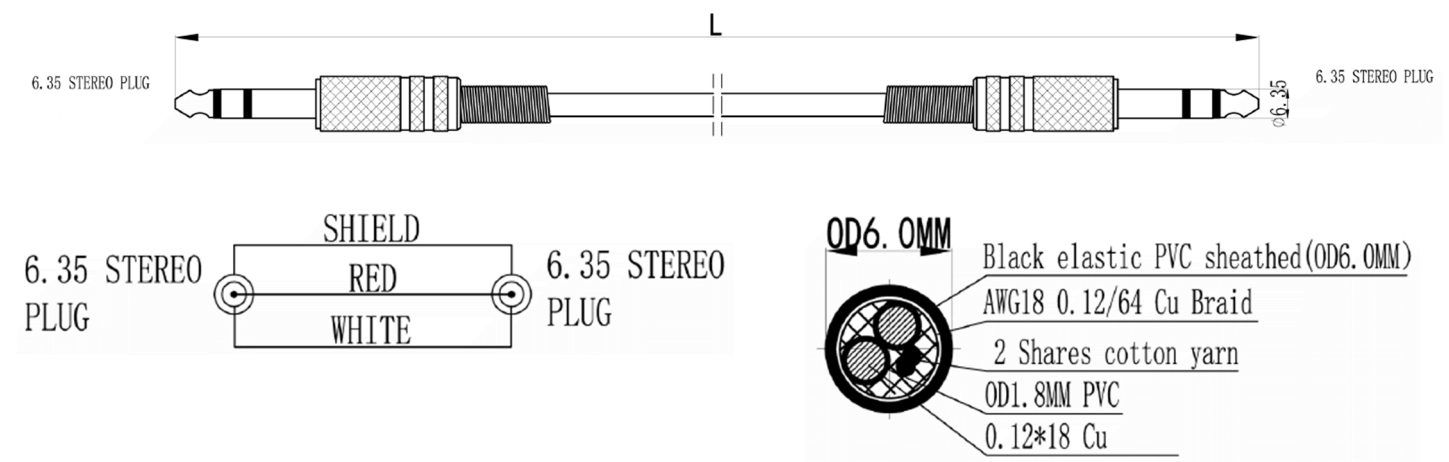

RoHS / REACH / CE