



ENGLISH

Datasheet

3 Pole Female Straight DIN Connector

RS Stock number [490-961](#)



MATERIAL :

1. SHIELD COVER : Zn ALLOY NICKEL PTD.
2. GND CONT. : COPPER NICKEL PTD.
3. HOUSING : PA66
4. TERMINALS : BRASS SILVER PTD.

Drawing (mm):

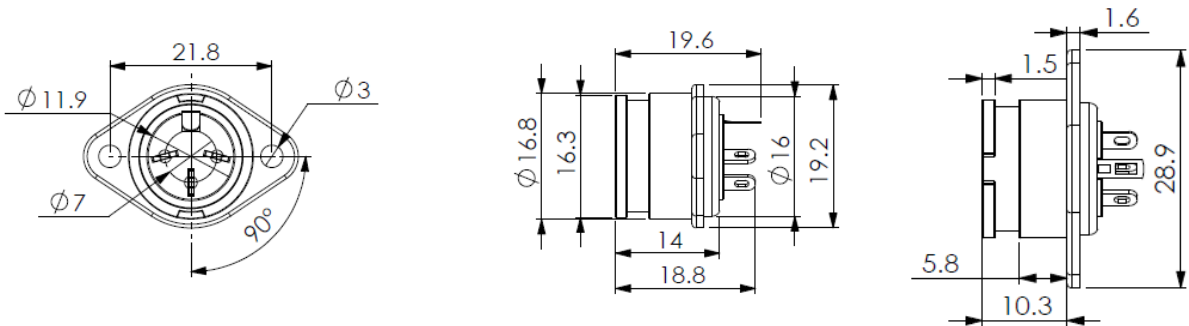

Specifications:

rating :

100V AC 4A MAX

contact resistance :

pins-30m Ω MAX; shell-50m Ω MAX

insulation resistance :

MIN 100 MEG Ω @500V DC

voltage withstand :

250V AC R.M.S. for 1 minute