

# HAND TOOLS







# Contents

- Cushion Grip Screwdrivers ..... 8 - 12
- MEGADORA Series ..... 13 - 15
- Plastic Grip Screwdrivers ..... 16 - 20
- Eco-friendly Screwdriver ..... 21 - 23
- Wooden Handle Screwdrivers ..... 24 - 25
- Non-Slip Screwdriver ..... 26 - 28
- Precision Screwdrivers ..... 29 - 31
- Functional Screwdrivers ..... 32 - 39
- Torque Screwdriver ..... 40 - 41
- Hex Wrenches / TORX Wrench ..... 42 - 47
- For particular job unique tools ..... 48 - 51

HAND TOOLS  
BITS & SOCKETS  
ELECTRIC TOOLS  
AIR TOOLS  
STATIC SOLUTIONS  
GASOLINE ENGINE TOOLS

## About ISO

**ISO 9001 : 2008**  
Our screwdriver manufacturing division, VESSEL SHIMANE CO., LTD is certified according to ISO standard, the global standard for quality assurance control.



**ISO 14001 : 2004**  
We obtained ISO 14001 in August 2010. VESSEL will further strive to offer eco-friendly products, aiming at minimizing the environmental burden as a manufacturing group.



# HAND TOOLS TECHNICAL

HAND TOOLS

BITS & SOCKETS

ELECTRIC TOOLS

AIR TOOLS

STATIC SOLUTIONS

GASOLINE ENGINE TOOLS

## Nominal designation based on shank types

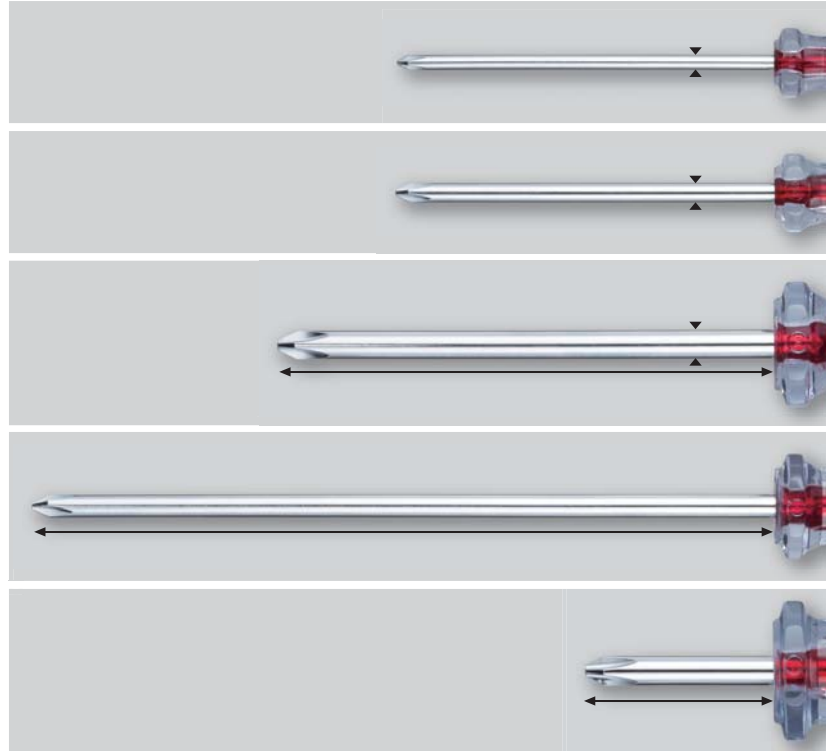

**Cr-V steel**  
**Cr-V Mo steel**

Good precision and durability nurtured in assembly lines Chrome vanadium steel that improves the shank strength

**Cr** (chromium): hardens the tip.  
**V** (vanadium): makes the tip tough.  
**MO** (molybdenum): improves strength, hardness, and even toughness.

### Precision shank A shank diameter of 3 mm or less

This is for precision small screws whose thread diameter is 1 to 3 mm.

### Slim shank A diameter of 4 mm

This is a long slender shank to avoid interference even in a narrow area.

### Standard shank

It has a popular shank diameter and length based on various standards.

### Long shank

This is suitable for screw tightening in deep and narrow areas.

### Stubby shank

This is a short shank suitable for work in a confined area.

### Hexagon bolster

This part allows a spanner, etc. to be applied to retighten a screw or undo a hard-tightened screw.

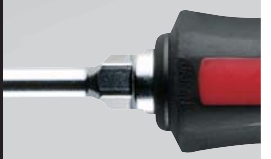

### Magnetized Tip-End

The tip-end is strongly magnetized to capture screws for better work efficiency.



**JAWSFIT®**

### NEW JAWSFIT

Coated specially with high strength metallic granules. This prevents CAM-OUT (phenomenon peculiar to cross recessed screws).



### Black point®

The tip-end with the black oxide finishment is insensitive to the effect of a plating layer thickness and highly precise.





### General type

Type in which a shank is held in the handle. It is electrically safe.

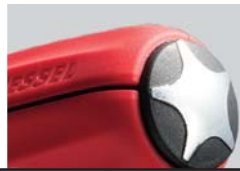

### Tang-thru type

A shank is installed through the handle so that the screwdriver can be used for position adjustment or screw-hole correction by tapping the head with a hammer.



### CAUTION

Safety icons are printed and indicated for easy identification. (Displayed in a stepwise manner on a product basis)



### Cushion

An elastomer is integrally formed on the exterior of the grip. It provides elastic grip, offering large tightening force.

8P



### Taper shape

Enabling a screwdriver to be easily taken out of a screwdriver holder. It is often used for screwdrivers related to electrical equipment.

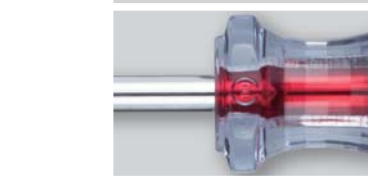

### Rolling prevention

Having a shape avoiding rolling over, which has also been widely adopted by overseas screwdrivers.



### Ergonomics design

The use of design taking into account the shape of the palm and enhancing the operability at the finger tips ensures comfortable screw tightening.

13P  
16P  
21P



### Wood handle

A long seller grip made of air-dried natural wood. It fits the palm of the hand as the tool is used longer.

24P



### Non-slip

VESSEL-developed non-slip surface features fine knurling process, enabling torque to be transmitted firmly even if there is oil on it.

26P



### Precision use

Designed to transmit a minute force efficiently. Intended for precision work

29P



### Other functional grips

A ratchet screwdriver allowing screw tightening to be made by mere repetition of wrist movement; an impact screwdriver used to undo a rusted or stuck screw, etc.

32P



### Environmental measures

Pb (lead), Cd (cadmium), Hg (mercury), hexavalent chromium, PBB (polybrominated biphenyl), and PBDE (polybrominated diphenyl ether)

This symbol indicates the products that conform to VESSEL's environment measure standards compliant with the restriction of the use of certain hazardous substances (six substances listed above) (RoHS directive).



No. 700

# Super Cushion Screwdriver



Highly elastic cushion grip.  
Fits the palm of the hand. No slipping.  
Transmits high torque to the tip.



A D V A N C E D  
**GEL-FUNCTION**  
T E C H N O L O G Y

**No. 700**  
**Super Cushion**  
**Screwdriver**

VESSEL Cushion Grip Screwdrivers fit not only screw heads but also your hand. This series assure the efficient torque transmission.



※The photograph is an image.

HAND TOOLS

BITS & SOCKETS

ELECTRIC TOOLS

AIR TOOLS

STATIC SOLUTIONS

GASOLINE ENGINE TOOLS

### No. 700 Super Cushion Screwdriver PAT.

- "Super Cushion" grip fits your hand perfectly.
- Rust-resistant black chrome plating.



No.700	Bit		Bit (mm)				Inner Ctn.	Outer Ctn.	EDP No.
⊖ 5.5 × 75	5.5	0.8	75	5.5	29	182	6	120	125211
⊖ 6 × 100	6.0	0.9	100	6.4	32	215	6	120	125212
⊖ 6 × 150	6.0	0.9	150	6.4	32	265	6	120	125213
⊖ 8 × 150	8.0	1.1	150	8.0	34	275	6	120	125214
⊕ 1 × 75	⊕No.1	75	5.5	29	182		6	120	125215
⊕ 2 × 100	⊕No.2	100	6.4	32	215		6	120	125216
⊕ 2 × 150	⊕No.2	150	6.4	32	265		6	120	125217
⊕ 3 × 150	⊕No.3	150	8.0	34	275		6	120	125218

### No. 720 Super Cushion Screwdriver (Stubby Type) PAT.

- "Super Cushion" grip fits your hand perfectly.
- Rust-resistant black chrome plating.
- Ideal for working in cramped places.



No.720	Bit		Bit (mm)				Inner Ctn.	Outer Ctn.	EDP No.
⊖ 6 × 15	6.0	0.9	15	6.0	35	68	6	120	125221
⊕ 1 × 15	⊕No.1	15	6.0	35	68		6	120	125222
⊕ 2 × 15	⊕No.2	15	6.0	35	68		6	120	125223

### No. 730 Super Cushion Tang-Thru Screwdriver PAT.

- "Super Cushion" grip fits your hand perfectly.
- Tang-thru type with a star-shaped end cap for hammering.
- Rust-resistant black chrome plating.



No.730	Bit		Bit (mm)				Inner Ctn.	Outer Ctn.	EDP No.
⊖ 5.5 × 75	5.5	0.8	75	5.5	29	182	6	120	125231
⊖ 6 × 100	6.0	0.9	100	6.4	32	215	6	120	125232
⊖ 6 × 150	6.0	0.9	150	6.4	32	265	6	120	125233
⊖ 8 × 150	8.0	1.1	150	8.0	34	276	6	60	125234
⊕ 1 × 75	⊕No.1	75	5.5	29	182		6	120	125235
⊕ 2 × 100	⊕No.2	100	6.4	32	215		6	120	125236
⊕ 2 × 150	⊕No.2	150	6.4	32	265		6	120	125237
⊕ 3 × 150	⊕No.3	150	8.0	34	276		6	60	125238

### No. 610 Cushion Grip Screwdriver (Thin Shank Type)

- Ideal for screw tightening in precision fields.
- Straight cut slotted tip good even for a use in cramped spaces.
- Highly precise black point tip, not being affected by the thickness of the plating layer.

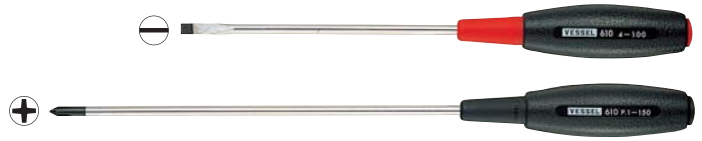

No.610	Bit		Bit (mm)				Inner Ctn.	Outer Ctn.	EDP No.
⊖ 4 × 75	4.0	0.5	75	4.0	20.5	162	12	120	125332
⊖ 4 × 100	4.0	0.5	100	4.0	20.5	187	12	120	125333
⊖ 4 × 150	4.0	0.5	150	4.0	20.5	237	12	120	125335
⊖ 4 × 200	4.0	0.5	200	4.0	20.5	287	12	120	125336
⊕ 00 × 75	⊕No.00	75	4.0	20.5	162		12	120	125337
⊕ 0 × 75	⊕No.0	75	4.0	20.5	162		12	120	125339
⊕ 0 × 100	⊕No.0	100	4.0	20.5	187		12	120	125340
⊕ 1 × 75	⊕No.1	75	4.0	20.5	162		12	120	125341
⊕ 1 × 100	⊕No.1	100	4.0	20.5	187		12	120	125342
⊕ 1 × 150	⊕No.1	150	4.0	20.5	237		12	120	125343

### No. 660 Cushion Grip Screwdriver (Stubby Type)

- With reversible blade (⊖5, ⊕2).

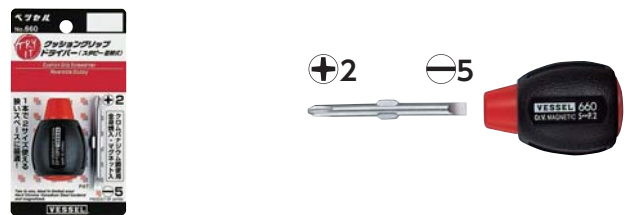

Set content		Package size (mm)	Inner Ctn.	Outer Ctn.	EDP No.
Grip	length 53mm dia. 35mm	135×75×35	10	60	133085
Reversible blade	⊖5 / ⊕2 ×60mm 1pc				

### No. TD-110 Cushion 4-way Stubby Screwdriver

- Handle can store 2 types of double-ended bit with different tip end.

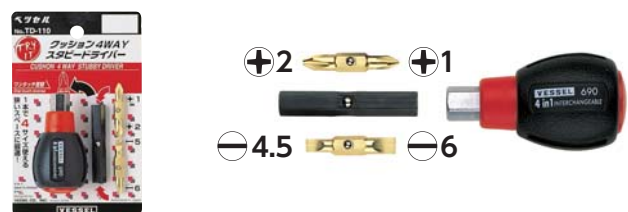

Set content		Package size (mm)	Inner Ctn.	Outer Ctn.	EDP No.
Grip	length 86mm dia. 35mm	135×85×35	10	60	251110
Reversible blade	⊕1 / ⊕2 ×35mm 1pc				
Holder	⊖4.5 / ⊖6 ×35mm 1pc				



**No. 220 Ball-Grip Screwdriver**

- Transmits ample tightening force to screw.
- Cushion grip color-coded by ⊕⊖.
- High precision black point tip.

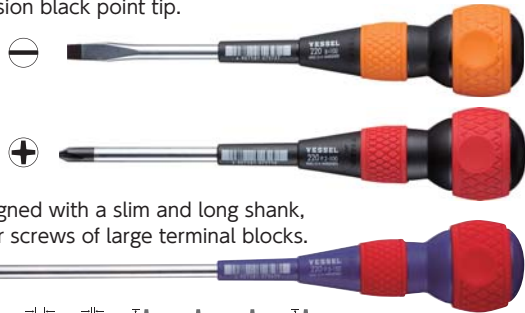

- ⊕3 is designed with a slim and long shank, optimal for screws of large terminal blocks.



No.220	1	2	3	4	5	6	Inner Ctn. (mm)	Outer Ctn.	EDP No.
⊖ 5.5 × 75	5.5	0.8	75	5.5	32	156	6	60	125351
⊖ 5.5 × 100	5.5	0.8	100	5.5	32	181	6	60	125361
⊖ 5.5 × 150	5.5	0.8	150	5.5	32	231	6	60	125362
⊖ 6 × 100	6.0	0.9	100	6.4	41	200	6	60	125352
⊖ 6 × 150	6.0	0.9	150	6.4	41	250	6	60	125353
⊖ 6 × 200	6.0	0.9	200	6.4	41	300	6	60	125354
⊕ 1 × 75	⊕No.1	75	5.5	32	156	6	60	125355	
⊕ 1 × 100	⊕No.1	100	5.5	32	181	6	60	125371	
⊕ 1 × 150	⊕No.1	150	5.5	32	231	6	60	125372	
⊕ 2 × 100	⊕No.2	100	6.4	41	200	6	60	125356	
⊕ 2 × 150	⊕No.2	150	6.4	41	250	6	60	125357	
⊕ 2 × 200	⊕No.2	200	6.4	41	300	6	60	125358	
⊕ 3 × 150	⊕No.3	150	6.4	41	250	6	60	125374	

**No. 220F Free-Turning Ball Grip Screwdriver (Screwdriver only)**

PAT.

- Free-turning hook enables fast turning.
- Elastomer resin excellently fits the hand.



No.220F	1	2	3	4	5	6	Inner Ctn. (mm)	Outer Ctn.	EDP No.
⊖ 6 × 100	6.0	0.9	100	6.4	41	200	6	60	125541
⊖ 6 × 150	6.0	0.9	150	6.4	41	250	6	60	125542
⊕ 2 × 100	⊕No.2	100	6.4	41	200	6	60	125543	
⊕ 2 × 150	⊕No.2	150	6.4	41	250	6	60	125544	

**No. B-640TX Cushion Grip TORX Screwdriver NEW**

- Optimal for fastening screws in precision fields.
- Non-electrolytic plating, keeping the precise tip quality.
- Cushion grip fitting comfortably in a hand.
- Also good for tamper-proof TORX screws (except T5 and T6).



No.B-640TX	1	2	3	4	5	Inner Ctn. (mm)	Outer Ctn.	EDP No.
T5	1.42	40	4.0	20.5	126	6	60	123561
T6	1.69	40	4.0	20.5	126	6	60	123562
T7H	1.97	40	4.0	20.5	126	6	60	123563
T8H	2.30	40	4.0	20.5	126	6	60	123564
T9H	2.48	40	4.0	20.5	126	6	60	123565

TORX® is a registered trademark of Acument TM Intellectual Properties, LLC (USA). VESSEL has a manufacturing license in Japan and selling same to the world.

**No. 230 Ball-Grip Tang-Thru Screwdriver**

- Tang-Thru shank with star end cap.
- Transmits ample tightening force to screw.
- Cushion grip color-coded by ⊕⊖.
- High precision black point tip.



No.230	1	2	3	4	5	6	Inner Ctn. (mm)	Outer Ctn.	EDP No.
⊖ 5.5 × 75	5.5	0.8	75	5.5	32	156	6	60	125311
⊖ 6 × 100	6.0	0.9	100	6.4	41	200	6	60	125314
⊖ 6 × 150	6.0	0.9	150	6.4	41	250	6	60	125315
⊕ 1 × 75	⊕No.1	75	5.5	32	156	6	60	125321	
⊕ 2 × 100	⊕No.2	100	6.4	41	200	6	60	125324	
⊕ 2 × 150	⊕No.2	150	6.4	41	250	6	60	125325	

**No. 265 "NEON" Screwdriver**

- Glow-in-the-dark type.
- High precision black point tip.

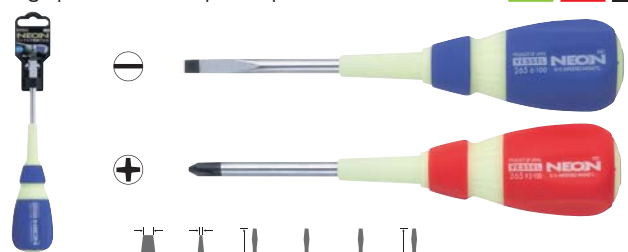

No.265	1	2	3	4	5	6	Inner Ctn. (mm)	Outer Ctn.	EDP No.
⊖ 6 × 100	6.0	0.9	100	6.4	40	185	6	60	125561
⊖ 6 × 150	6.0	0.9	150	6.4	40	235	6	60	125562
⊕ 2 × 100	⊕No.2	100	6.4	40	185	6	60	125563	
⊕ 2 × 150	⊕No.2	150	6.4	40	235	6	60	125564	

**No. 225 Ball-Grip Screwdriver (With covered shank)**

- Resin-covered shank. It prevents electrical short circuit.
- Transmits ample tightening force to screw.
- Cushion grip is marked ⊕⊖ for quick identification.

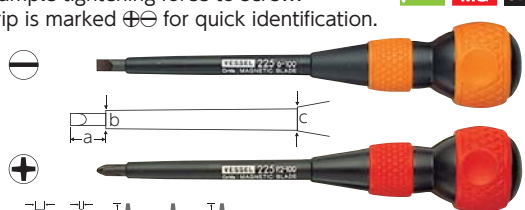

No.225	1	2	3	4	5	6	7	8	9	10	Inner Ctn. (mm)	Outer Ctn.	EDP No.
⊖ 6 × 100	6.0	0.9	100	41	200	14	8	10	6	60	125382		
⊖ 6 × 150	6.0	0.9	150	41	250	14	8	10	6	60	125383		
⊕ 2 × 100	⊕No.2	100	41	200	14	8	10	6	60	125389			
⊕ 2 × 150	⊕No.2	150	41	250	14	8	10	6	60	125390			

⚠ Electric insulation is not guaranteed. For safety purposes, shut off power before use. The covered shaft protects against unexpected shorts. Should it become scratched, damaged or deteriorated, do not use the screwdriver.

HAND TOOLS

BITS & SOCKETS

ELECTRIC TOOLS

AIR TOOLS

STATIC SOLUTIONS

GASOLINE ENGINE TOOLS

**No. 250 Tang-Thru Screwdriver w/Ceramic Ball (For electric works)**

- Incorporates a ceramic ball preventing electricity from being conducted.
- Uses zirconia ceramics having the highest rigidity and wear resistance among ceramics.
- Easy to tap with a hammer on the large nut.
- High-precision black point tip.



No.250							Inner Ctn.	Outer Ctn.	EDP No.
⊖ 6 × 100	6.0	0.9	100	6.4	41	200	6	60	112105
⊖ 6 × 150	6.0	0.9	150	6.4	41	250	6	60	112106
⊕ 2 × 100	⊕No.2	100	6.4	41	200	6	60	112107	
⊕ 2 × 150	⊕No.2	150	6.4	41	250	6	60	112108	

**One point**

Tang-thru screwdriver No. 250 that incorporates a ceramic ball preventing electricity from being conducted

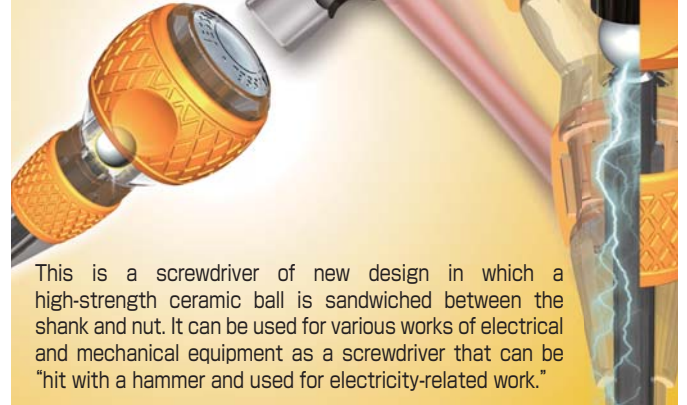

This is a screwdriver of new design in which a high-strength ceramic ball is sandwiched between the shank and nut. It can be used for various works of electrical and mechanical equipment as a screwdriver that can be "hit with a hammer and used for electricity-related work."

⚠ Electric insulation is not guaranteed. For safety purposes, shut off power before use.

**No. 220W Ball Grip (Bit-replaceable grip)**

- Compatibility with a 6.35mm hex drive bit enables to be used as a familiar ball grip screwdriver.



Model No.	Grip size	Package size (mm)	Outer Ctn.	EDP No.
220W	length 100mm, dia.41mm	145×50×43	10	125344

**No. 230W Ball Grip (Bit-replaceable Tang-Thru grip) NEW**

- Blade interchangeable tang-thru grip. (A/F6.35mm)
- 25mm large nut incorporated transmitting well the hammering power.



Model No.	Grip size	Package size (mm)	Inner Ctn.	EDP No.
230W	length 100mm, dia.41mm	145×50×43	10	125326

**No. 270BW Cushion Stubby (Bit-replaceable grip)**

- Stubby type optimal for a narrow area. Compatibility with a 6.35mm hex drive bit for electric screwdrivers.



Model No.	Grip size	Package size (mm)	Outer Ctn.	EDP No.
270BW	length 55.5mm, dia.35mm	100×50×37	10	233074

**One point**

**Features of replacement grip**

This is a screwdriver grip enabling a electric driver bit of a hexagonal width-across-flats of 6.35 mm to be inserted and used.

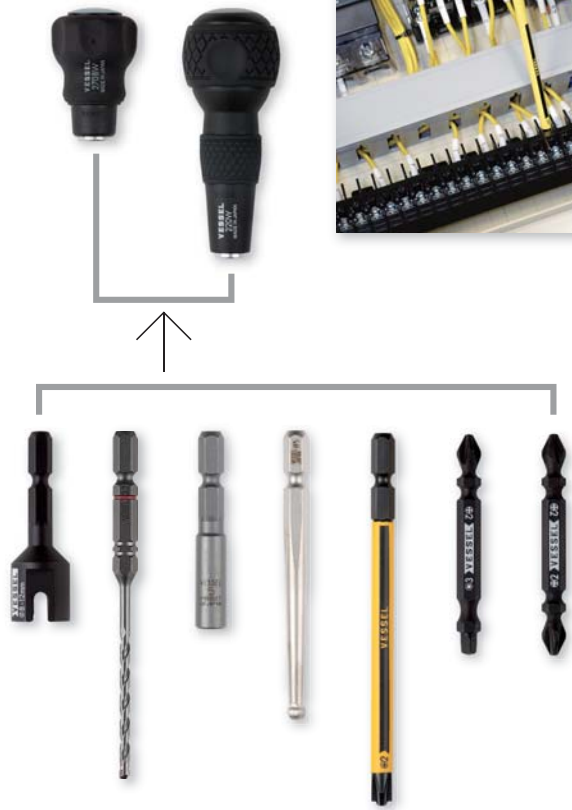



**No. 210 Ball Grip Screwdriver (for electric works) NEW**

- 125mm long shank is good for screw-tightening even deep in distribution boards and ideal for not contacting the floor when squatting.
- High-precision black point tip.



No.210		Bit (mm)						Inner Ctn.	Outer Ctn.	EDP No.
⊖ 6×	125	6.0	0.9	125	6.4	41	225	6	60	125575
⊕ 2×	125	⊕No.2	125	6.4	41	225	6	60	125574	

**No. 2200 Ball Ratchet Screwdriver NEW**

- With 36-teeth gear ratchet to realize comfortable operation with fine tuning.
- Shank cover prevents short circuits. Thin shank is convenient for operating on terminal blocks.
- Shank uses bit materials, fully hardened. Replacement shank is available as option.



No.2200		Bit (mm)						Inner Ctn.	Outer Ctn.	EDP No.
⊖ 6×	100	6.0	0.8	100	6.0	41	200	6	60	125395
⊖ 6×	150	6.0	0.8	150	6.0	41	250	6	60	125396
⊕ 2×	100	⊕No.2	100	6.0	41	200	6	60	125345	
⊕ 2×	150	⊕No.2	150	6.0	41	250	6	60	125346	
⊕ 3×	150	⊕No.3	150	6.0	41	250	6	60	125347	

⚠ Electric insulation is not guaranteed. For safety purposes, shut off power before use.

**No. 210ST Slim Free-Turning Ball Grip Screwdriver (for electric works) NEW**

- 125mm long shank is good for screw-tightening even deep in distribution boards and ideal for not contacting the floor when squatting.
- Provided with a slim free-turning part, which enables fast turning and smooth on/off from the screwdriver holder.

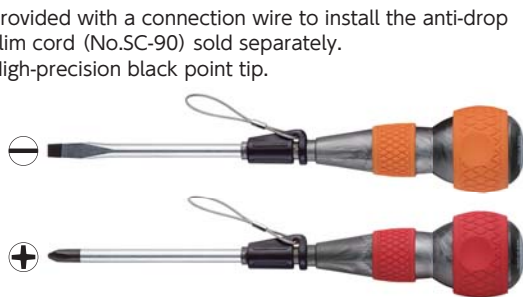

No.210ST		Bit (mm)						Inner Ctn.	Outer Ctn.	EDP No.
⊖ 6×	125	6.0	0.9	125	6.4	41	225	6	60	125577
⊕ 2×	125	⊕No.2	125	6.4	41	225	6	60	125576	

**No. 2200B Ball Ratchet Screwdriver Reversible Blade NEW**

- Shank uses bit materials, fully hardened.
- Replacement blade; can be replaced by pulling out the ball-grip part of No.2200.



No.2200B		Bit (mm)						Inner Ctn.	Outer Ctn.	EDP No.
⊖ 6×	100	6.0	0.8	100	6.0	158	6	60	125397	
⊖ 6×	150	6.0	0.8	150	6.0	208	6	60	125398	
⊕ 2×	100	⊕No.2	100	6.0	158	6	60	125348		
⊕ 2×	150	⊕No.2	150	6.0	208	6	60	125349		
⊕ 3×	150	⊕No.3	150	6.0	208	6	60	125350		

**No. SC-90 Anti-drop Slim Cord NEW**

- Cord to prevent screwdrivers from dropping.
- Provided with a sleeve to avoid rings forming, which cause the cord to get caught.



Package content		Inner Ctn.	EDP No.
Mounted load	500g or less	10	125405
Length	482 (maximum length 1500) mm		
Material	Sleeve: polypropylene		
	Rubber band: polypropylene and natural rubber		

**One point**  
Move the sleeve to straighten the cord!



HAND TOOLS

BITS & SOCKETS

ELECTRIC TOOLS

AIR TOOLS

STATIC SOLUTIONS

GASOLINE ENGINE TOOLS

No. 980

# MEGADORA IMPACTA



Our proprietary Tang-thru nut incorporates cam rotation mechanism, which turns the driving tip counter-clockwise by 12 degrees when the handle is hit with a hammer.

IMPACTA leverages impact acceleration to remove stuck screws.

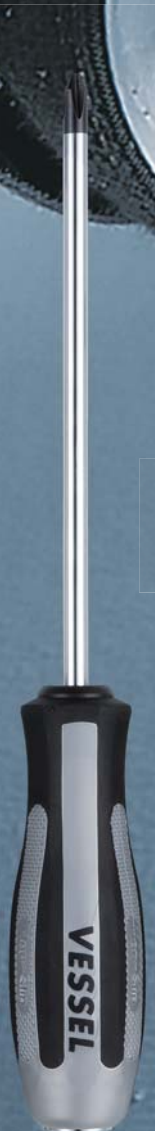

Distorted screws

Rusted screw

Stuck screws

12°

No. 980

## MEGADORA IMPACTA

Equipped with a flat-surface grip and cushions on the corners of the hexagonal cross section. The inner core is a triple-layered construction using recycled resin, designed with practical use of resources.

※This is for illustrative purpose.



**No. 980 MEGADORA IMPACTA PAT.**

- Tang-Thru nut with cam rotation mechanism.
- High precision black point tip.



No.980							Inner Ctn.	Outer Ctn.	EDP No.
⊕ 2 × 100	⊕No.2	100	6.4	34	213	6	60	125941	
⊕ 2 × 150	⊕No.2	150	6.4	34	263	6	60	125942	
⊕ 3 × 150	⊕No.3	150	8.0	36	278	6	60	125943	

**No. 900 MEGADORA Standard Screwdriver Extra Long Type PAT.**

- Philips JAWSFIT tip that firmly grips the screw. **JAWSFIT**
- Good for a work deep in a space.
- Useful for adjustment of automotive headlight and removal of a hose band.
- Junk (turning) grip minimizes shaking because of the long shank, to ensure stable tightening.



No.900							Inner Ctn.	Outer Ctn.	EDP No.
⊖ 6 × 400	⊖No.2	400	6.4	34	510	6	60	125709	
⊕ 2 × 400	⊕No.2	400	6.4	34	510	6	60	125710	

**No. 900 MEGADORA Standard Screwdriver PAT.**

- NEW Philips JAWSFIT tip that firmly grips the screw. **JAWSFIT**
- A knurled shank is useful for fast and slipless turning by fingers and open wide holes on a wood material or a board.



No.900							Inner Ctn.	Outer Ctn.	EDP No.
⊖ 5.5 × 75	5.5	0.8	75	5.5	30	175	6	60	125701
⊖ 6 × 100	6.0	0.9	100	6.4	34	210	6	60	125702
⊖ 6 × 150	6.0	0.9	150	6.4	34	260	6	60	125703
⊖ 8 × 150	8.0	1.1	150	8.0	36	275	6	60	125704
⊕ 1 × 75	⊕No.1	75	5.5	30	175	6	60	125705	
⊕ 2 × 100	⊕No.2	100	6.4	34	210	6	60	125706	
⊕ 2 × 150	⊕No.2	150	6.4	34	260	6	60	125707	
⊕ 3 × 150	⊕No.3	150	8.0	36	275	6	60	125708	

**No. 920 MEGADORA Stubby Screwdriver**

- Philips JAWSFIT tip that firmly grips the screw. **JAWSFIT**
- 25mm-long shank. Ideal for working in cramped places.

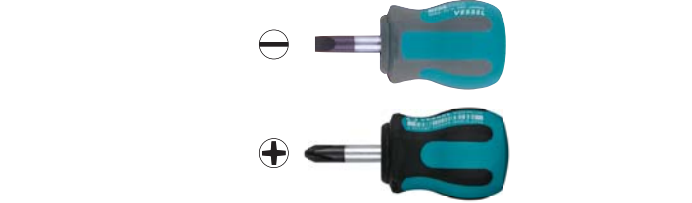

No.920							Inner Ctn.	Outer Ctn.	EDP No.
⊖ 6 × 25	6.4	0.9	25	6.4	36	75	6	60	125752
⊕ 1 × 25	⊕No.1	25	6.4	36	75	6	60	125753	
⊕ 2 × 25	⊕No.2	25	6.4	36	75	6	60	125754	

**No. 930 MEGADORA Tang-Thru Screwdriver PAT.**

- NEW Philips JAWSFIT tip that firmly grips the screw. **JAWSFIT**
- Tang-Thru shank with large end cap.
- With a hexagonal bolster for spanner.



No.930							Inner Ctn.	Outer Ctn.	EDP No.
⊖ 5.5 × 75	5.5	0.8	75	5.5	30	175	8	60	125711
⊖ 6 × 38	6.0	0.9	38	6.4	34	151	—	60	125719
⊖ 6 × 100	6.0	0.9	100	6.4	34	213	10	60	125712
⊖ 6 × 150	6.0	0.9	150	6.4	34	263	10	60	125713
⊖ 8 × 150	8.0	1.1	150	8.0	36	278	12	60	125714
⊕ 1 × 75	⊕No.1	75	5.5	30	176	8	60	125715	
⊕ 2 × 100	⊕No.2	100	6.4	34	213	10	60	125716	
⊕ 2 × 150	⊕No.2	150	6.4	34	263	10	60	125717	
⊕ 3 × 150	⊕No.3	150	8.0	36	278	12	60	125718	

**No. 910 MEGADORA Thin Shank Screwdriver**

- Precision type with 4 mm or smaller diameter shank.
- Black point tip, unaffected by the plating thickness.

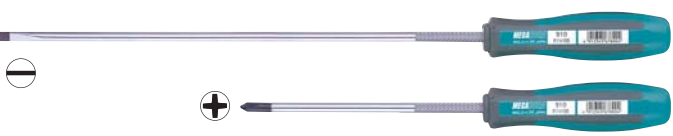

No.910							Inner Ctn.	Outer Ctn.	EDP No.
⊖ 3 × 75	3.0	0.4	75	3.0	21	153	12	120	125746
⊖ 3 × 100	3.0	0.4	100	3.0	21	178	12	120	125747
⊖ 4 × 75	4.0	0.5	75	4.0	21	153	12	120	125748
⊖ 4 × 100	4.0	0.5	100	4.0	21	178	12	120	125749
⊖ 4 × 150	4.0	0.5	150	4.0	21	228	12	120	125750
⊖ 4 × 200	4.0	0.5	200	4.0	21	278	12	120	125751
⊕ 0 × 75	⊕No.0	75	3.0	21	153	12	120	125742	
⊕ 0 × 100	⊕No.0	100	3.0	21	178	12	120	125743	
⊕ 1 × 75	⊕No.1	75	4.0	21	153	12	120	125744	
⊕ 1 × 100	⊕No.1	100	4.0	21	178	12	120	125745	

HAND TOOLS

BITS & SOCKETS

ELECTRIC TOOLS

AIR TOOLS

STATIC SOLUTIONS

GASOLINE ENGINE TOOLS

### No. 970 MEGADORA Clip Remover **PAT.**

- One model for both large and small tips. Suited for many clips used with automobiles.
- Chrome plating, not causing scratches on a painted metal plate.
  - Optimally angled for working in cramped spaces, such as, door trim, wire binding clip, and so on.



No.970	CR × 120	12/7	120	7.0	34	230	(mm)	Inner Ctn.	Outer Ctn.	EDP No.
								6	60	125721

### No. 970 MEGADORA Chisel-Type Screwdriver **PAT.**

- Special steel for high quality cold chisel used. Hardness: 58HRC. Abrasion resistant and sharp edge.
- Elastomer-resin made grip absorbs shock when using and alleviate the fatigue on the hand.
  - Tang-Thru shank with large end cap. Less deformative case hardening nut.



No.970	7 × 100	9.5 × 120	7.0	1.5	100	6	34	213	(mm)	Inner Ctn.	Outer Ctn.	EDP No.
			9.5	1.7	120	8	36	248		6	60	125722
										6	60	125732

## One point

Pull out / Break



MEGADORA Clip Remover



Removing it by leverage

One model compatible with 2 popular types of clip in the automobile industry.



High-grade chisel used.



Sharp edge and anti-abrasion quality. Good for removal of welding on a spot, of burrs, and for various work with tiles and bricks.



MEGADORA Chisel-Type Screwdriver

### No. 944TX 4-Piece MEGADORA FOD TORX Screwdriver Set **PAT.**

- Used for work in automobile maintenance field
- Provided with a two-layer structured tray that prevents a screwdriver from being left.

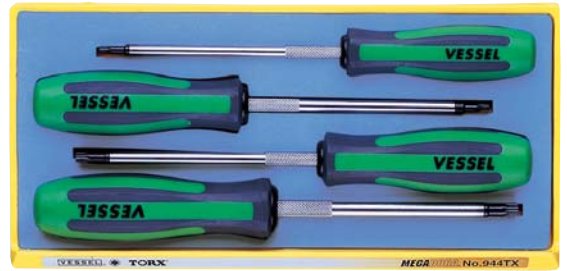

→ See P45 One point

No.940TX	Set content	Tray size (mm)	Inner Ctn.	Outer Ctn.	EDP No.
	T20H×120, T25H×120 T30H×120, T40H×120	280×135×35	1	20	125804

TORX® is a registered trademark of Acument™ Intellectual Properties, LLC (USA). VESSEL has a manufacturing license in Japan and selling same to the world.

### No. S-903 MEGADORA Pozidriv Screwdriver

- Dedicated to Pozidriv screws.
- VESSEL is an official licensee of Pozidriv.
- A knurled shank is useful for fast turning.



No.S-903	PZ1 × 75	PZ2 × 100	PZ3 × 150						(mm)	Inner Ctn.	EDP No.
				PZ No.1	75	5.5	30	175		6	267254
				PZ No.2	100	6.4	34	210		6	267255
				PZ No.3	150	8.0	36	275		6	267256



No. 6300

# "CRYSTALINE" Screwdriver

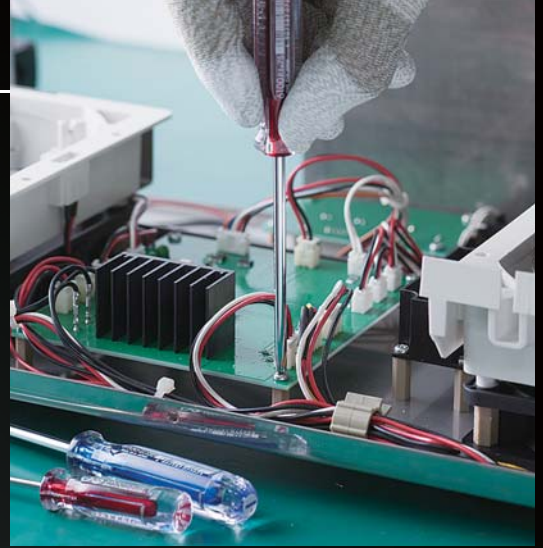

We have created a colorful grip with a crystalline sparkle. We offer an abundant lineup of shank sizes, including those capable of accessing deeply recessed or narrow areas.



No. 6300

## "CRYSTALINE" Screwdriver

Uses cellulose acetate resin with good oil and chemical resistance. Uses raw materials such as wood and cotton (literal meaning of cellulose).

HAND TOOLS

BITS & SOCKETS

ELECTRIC TOOLS

AIR TOOLS

STATIC SOLUTIONS

GASOLINE ENGINE TOOLS



### No. 6300 "CRYSTALINE" Screwdriver PAT.

- Bright quartz "CRYSTALINE" handles. Color coding by ⊕⊖.
- Uses cellulose acetate resin.

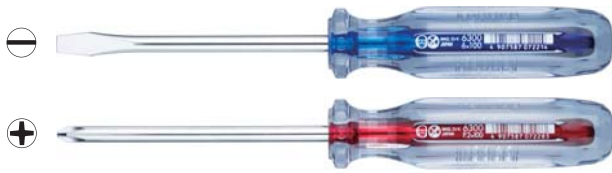

No.6300							Inner Ctn.	Outer Ctn.	EDP No.
⊖ 4.5 × 50	4.5	0.6	50	5.0	22.0	138	12	240	121201
⊖ 5.5 × 75	5.5	0.8	75	5.5	22.0	163	12	240	121202
⊖ 6 × 100	6.0	0.9	100	6.0	26.5	205	12	240	121203
⊖ 8 × 150	8.0	1.1	150	8.0	28.5	263	12	120	121205
⊖ 9 × 200	9.0	1.2	200	9.0	28.5	313	6	60	121206
⊖ 10 × 250	10.0	1.2	250	9.0	28.5	363	6	60	121207
⊖ 10 × 300	10.0	1.2	300	9.0	28.5	413	6	60	121208
⊕ 1 × 75	⊕No.1	75	5.0	22.0	163		12	240	121209
⊕ 2 × 100	⊕No.2	100	6.0	26.5	205		12	240	121210
⊕ 3 × 150	⊕No.3	150	8.0	28.5	263		12	120	121211
⊕ 4 × 200	⊕No.4	200	9.0	28.5	313		6	60	121212

### No. 6300 "CRYSTALINE" Screwdriver (Long Shank Type) PAT.

- Bright quartz "CRYSTALINE" handle. Marked for ⊕⊖.
- Long shank for fastening in a hard-to-reach space.
- Uses cellulose acetate resin.



No.6300							Inner Ctn.	Outer Ctn.	EDP No.
⊖ 5 × 150	5.0	0.8	150	4.8	22	238	12	120	121213
⊖ 5 × 200	5.0	0.8	200	4.8	22	288	12	120	121214
⊖ 5 × 250	5.0	0.8	250	4.8	22	338	12	120	121215
⊕ 1 × 150	⊕No.1	150	4.8	22	238		12	120	121216
⊕ 1 × 200	⊕No.1	200	4.8	22	288		12	120	121217
⊕ 1 × 250	⊕No.1	250	4.8	22	338		12	120	121218
⊕ 2 × 150	⊕No.2	150	6.0	26.5	255		12	120	121219
⊕ 2 × 200	⊕No.2	200	6.0	26.5	305		12	120	121220
⊕ 2 × 250	⊕No.2	250	6.0	26.5	355		12	120	121221

### No. 6900 "CRYSTALINE" Screwdriver (Precision Type) PAT.

- Bright quartz "CRYSTALINE" handle. Marked for ⊕⊖.
- For intense precision work.
- Handle butt is recessed to allow pressing with fingertips for fast turning.
- Uses cellulose acetate resin.

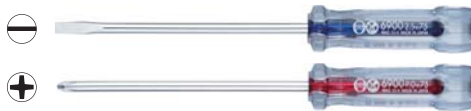

No.6900							Inner Ctn.	Outer Ctn.	EDP No.
⊖ 2.5 × 50	2.5	0.35	50	3	14	101	24	240	121301
⊖ 2.5 × 75	2.5	0.35	75	3	14	126	24	240	121302
⊖ 2.5 × 100	2.5	0.35	100	3	14	151	24	240	121303
⊕ 00 × 50	⊕No.00	50	3	14	101		24	240	121327
⊕ 0 × 75	⊕No.0	75	3	14	126		24	240	121304

### No. 6100 "CRYSTALINE" Screwdriver (Thin Shank Type) PAT.

- Bright quartz "CRYSTALINE" handle. Marked for ⊕⊖.
- Thin shank screwdriver. Ideal for working in cramped spaces.
- Uses cellulose acetate resin.



No.6100							Inner Ctn.	Outer Ctn.	EDP No.
⊖ 4 × 50	4.0	0.45	50	4	16	124.5	12	240	121001
⊖ 4 × 75	4.0	0.45	75	4	16	149.5	12	240	121002
⊖ 4 × 100	4.0	0.45	100	4	16	174.5	12	240	121003
⊖ 4 × 150	4.0	0.45	150	4	16	224.5	12	120	121005
⊖ 4 × 200	4.0	0.45	200	4	16	274.5	12	120	121006
⊕ 0 × 75	⊕No.0	75	4	16	149.5		12	240	121323
⊕ 0 × 100	⊕No.0	100	4	16	174.5		12	240	121009
⊕ 0 × 150	⊕No.0	150	4	16	224.5		12	120	121325
⊕ 0 × 200	⊕No.0	200	4	16	274.5		12	120	121326
⊕ 1 × 75	⊕No.1	75	4	16	149.5		12	240	121008
⊕ 1 × 100	⊕No.1	100	4	16	174.5		12	240	121012
⊕ 1 × 150	⊕No.1	150	4	16	224.5		12	120	121013
⊕ 1 × 200	⊕No.1	200	4	16	274.5		12	120	121014
⊕ 2 × 200	⊕No.2	200	4	16	274.5		12	120	121015
⊕ 2 × 250	⊕No.2	250	4	16	324.5		12	120	121016

### No. 6200 "CRYSTALINE" Screwdriver (Stubby Type) PAT.

- Bright quartz "CRYSTALINE" handle. Marked for ⊕⊖.
- Ideal for working in cramped spaces.
- Uses cellulose acetate resin.



No.6200							Inner Ctn.	Outer Ctn.	EDP No.
⊖ 6 × 38	6.0	0.9	38	6	30	87.5	12	240	121101
⊕ 1 × 38	⊕No.1	38	6	30	87.5		12	240	121102
⊕ 2 × 38	⊕No.2	38	6	30	87.5		12	240	121103

## One point

### An Eco-friendly grip made from plant-based ingredients

Cellulose acetate resin, used in many plastic screwdrivers, is once again in the spotlight as an ecologically friendly plant-based polyester resin. Cellulose acetate resin is an outstanding material that is resistant to oil, chemicals, and shock. As the word cellulose implies, the grip is made from wood pulp and cotton. This resin grip is ecologically friendly with a low environment load, and does not upset the CO2 balance when burned.





**No. 6603 Long Square Shank Screwdriver PAT.**

- 450mm-long square shank. Fully hardened tough special steel.
- Effective with high strength tightening.
- For fastening screws of sanitary appliances, etc.
- Uses cellulose acetate resin.



**No.6603**

							Outer Ctn. (mm)	EDP No.
⊖ 9 × 450	9.0	1.2	450	8	113	28.5	563	6 122231
⊕ 2 × 450	⊕No.2	450	6	113	28.5	563		6 122232
⊕ 3 × 450	⊕No.3	450	8	113	28.5	563		6 122233

**No. 4500 Power Grip Screwdriver**

- Plastic handle and tang-thru shank stand up to heavy-duty work.
- Hexagon bolster for strong tightening with a spanner or alike.
- Cellulose acetate resin grip. Ergonomic design.



**No.4500**

								Inner Ctn. (mm)	Outer Ctn. (mm)	EDP No.
⊖ 5.5 × 75	5.5	0.8	75	5.8	28.0	172	8	6	240	123401
⊖ 6 × 100	6.0	0.9	100	6.4	31.8	204	10	6	120	123402
⊖ 8 × 150	8.0	1.1	150	8.0	35.6	265	12	6	120	123403
⊖ 9 × 200	9.0	1.2	200	9.0	37.0	320	12	6	60	123404
⊕ 1 × 75	⊕No.1	75	5.8	28.0	172	8		6	240	123405
⊕ 2 × 100	⊕No.2	100	6.4	31.8	204	10		6	120	123406
⊕ 3 × 150	⊕No.3	150	8.0	35.6	265	12		6	120	123407
⊕ 4 × 200	⊕No.4	200	9.0	37.0	320	12		6	60	123408

**No. B-370 Non-slip tang-thru screwdrivers**

- Unique Non-Slip finish that prevents slipping even if oil adheres on the grip.
- Tang-thru type with a large nut. Good for heavy duty work.
- The end of the handle has a color ring facilitates to distinguish the tip difference at a glance.



**No.B-370**

							Inner Ctn. (mm)	Outer Ctn. (mm)	EDP No.
⊖ 5.5 × 75	5.5	0.8	75	5.5	27.4	183	6	60	267590
⊖ 6 × 100	6.0	0.9	100	6.4	30.7	226	6	60	267591
⊖ 8 × 150	8.0	1.1	150	8.0	36.2	290	6	60	267592
⊕ 1 × 75	⊕No.1	75	5.5	27.4	183		6	60	267593
⊕ 2 × 100	⊕No.2	100	6.4	30.7	226		6	60	267594
⊕ 3 × 150	⊕No.3	150	8.0	36.2	290		6	60	267595

**No. 4100 Power Socket Screwdriver**

- For fastening and loosening hexagon bolts and nuts.

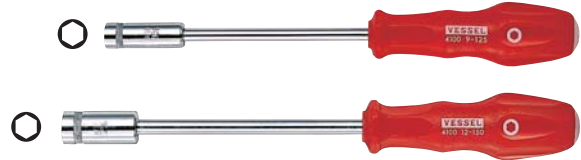

**No.4100**

								Inner Ctn. (mm)	Outer Ctn. (mm)	EDP No.
A/F 5 × 115	5	8	18	115	5.0	28.0	212	6	60	123501
A/F 5.5 × 115	5.5	9	18	115	5.0	28.0	212	6	60	123502
A/F 6 × 115	6	9	18	115	5.5	28.0	212	6	60	123503
A/F 7 × 125	7	10	18	125	5.5	28.0	222	6	60	123504
A/F 8 × 125	8	12	20	125	5.5	31.8	229	6	60	123505
A/F 9 × 125	9	12.7	20	125	6.3	31.8	229	6	60	123506
A/F 10 × 125	10	15	20	125	7.0	35.6	240	6	60	123507
A/F 11 × 125	11	15	20	125	7.0	35.6	240	6	60	123508
A/F 12 × 150	12	17	20	150	8.0	35.6	265	6	60	123509
A/F 13 × 150	13	19	20	150	8.0	35.6	265	6	60	123510

**No. 4600 POZIDRIV Screwdriver**

- High precision black point tip.
- Good for assembly of European and American furniture and skiing equipment.



**No.4600**

						Inner Ctn. (mm)	EDP No.
PZ1 × 75	PZ No.1	75	5	28	172	6	636011
PZ2 × 100	PZ No.2	100	6	31	204	6	636012
PZ3 × 150	PZ No.3	150	8	35	265	6	636013

**No. 5400TX Power Grip TORX Screwdriver**

- Champagne gold plating keeping the precise tip quality.
- Cellulose acetate resin grip. Ergonomic design.
- For working with tamper-proof screws (T5 and T6 excluded).



→ See P45 One point

**No.5400TX**

								Inner Ctn. (mm)	Outer Ctn. (mm)	EDP No.
T 5 × 80	1.42	80	2.5	17.0	155	12	60	122854		
T 6 × 80	1.69	80	2.5	17.0	155	12	60	122855		
T 7H × 80	1.97	80	2.5	17.0	155	12	60	122856		
T 8H × 80	2.3	80	3.0	17.0	155	12	60	122857		
T 9H × 80	2.48	80	3.0	17.0	155	12	60	122858		
T10H × 80	2.72	80	3.0	17.0	155	12	60	122859		
T15H × 80	3.26	80	3.5	28.0	177	6	60	122860		
T20H × 120	3.84	120	4.0	28.0	217	6	60	122861		
T25H × 120	4.4	120	5.0	31.8	224	6	60	122862		
T27H × 120	4.96	120	5.0	31.8	224	6	60	122863		
T30H × 120	5.49	120	6.0	35.6	235	6	60	122864		
T40H × 120	6.6	120	7.0	35.6	235	6	60	122865		

TORX® is a registered trademark of Acument TM Intellectual Properties, LLC (USA). VESSEL has a manufacturing license in Japan and selling same to the world.

HAND TOOLS

BITS & SOCKETS

ELECTRIC TOOLS

AIR TOOLS

STATIC SOLUTIONS

GASOLINE ENGINE TOOLS

## No. B-5400BP Power Grip UltraBall Screwdriver

- Champagne gold plating keeping the precise tip quality.
- Cellulose acetate resin grip. Ergonomic design.
- A knurled shank keeps hands from slipping in fast turning.



No. B-5400BP	Bit	Length (mm)	Shaft Dia. (mm)	Tip Dia. (mm)	Tip Length (mm)	Overall Length (mm)	Outer Ctn.	EDP No.
H 1.5 × 80	1.5	80	2.5	17.0	155	30	267565	
H 2 × 80	2	80	3.0	17.0	155	30	267566	
H 2.5 × 80	2.5	80	3.0	17.0	155	30	267567	
H 3 × 120	3	120	3.5	28.0	217	30	267568	
H 4 × 120	4	120	5.0	31.8	224	30	267569	
H 5 × 120	5	120	6.0	35.6	235	30	267570	
H 6 × 120	6	120	7.0	35.6	235	30	267571	

## No. TD-210 3-Point Cross Screwdriver

- 3 sizes in 1 compact handy tool.
- Y-handle fits in the palm of the hand. Delivers powerful fastening strength.

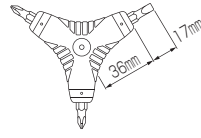

Set content	Package size (mm)	Inner Ctn.	Outer Ctn.	EDP No.
⊕1 / ⊕2 / ⊖6	135×120×20	10	60	251210

## No. TX-10 TORX Screwdriver Set

- Provided with bits in a holder.
- Also good for tamper-proof screws.
- New type of bit holder that assuredly holds bits.
- Bit insertion part ●6.35mm
- Cellulose acetate resin grip. Ergonomic design.



Set content	Package size (mm)	Outer Ctn.	EDP No.
Body length 204mm dia. 31.8mm	235×100×31	10	252020
Bits T10H, T15H, T20H, T25H, T27H, T30H, T40H, ⊕2, ⊕3, ⊖6×25.4mm			

Accessories Bit belt holder

TORX® is a registered trademark of Acument TM Intellectual Properties, LLC (USA). VESSEL has a manufacturing license in Japan and selling same to the world.

## No. TD-6310HX Hex Screwdriver Set NEW

- Bit insertion part ●6.35mm. Magnetized.
- Holds securely short bits. Reliable fastening as the bit does not drop easily.
- Grip made of environmental-friendly plant material.
- Provided with a bit belt for storage.



Set content	Package size (mm)	Outer Ctn.	EDP No.
Body length 213mm dia. 28.5mm	235×100×29	10	247029
Bits ⊖4, ⊖6, ⊕4, ⊕4, ⊕4, H2.5, H3, H4, H5, H6×25.4mm			

Accessories Bit belt holder

## No. TD-250Y/ 220B/ 240G 3-Point Screwdriver

- 3 sizes in 1 compact handy tool.
- Y-handle fits in the palm of the hand. Delivers powerful fastening strength.

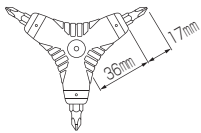

⊕ No. TD-250Y    ● No. TD-220B    ● No. TD-240G

Model No.	Set content	Package size (mm)	Inner Ctn.	EDP No.
TD-250Y	⊕1 / ⊕2 / ⊕3	120×95×18	10	251211
TD-220B	H2 / H2.5 / H3	120×95×18	10	251221
TD-240G	H4 / H5 / H6	120×95×18	10	251222

## No. TD-6310TX TORX Screwdriver Set NEW

- Bit insertion part ●6.35mm. Magnetized.
- Holds securely short bits. Reliable fastening as the bit does not drop easily.
- Grip made of environmental-friendly plant material.
- Provided with a bit belt for storage.



Set content	Package size (mm)	Outer Ctn.	EDP No.
Body length 213mm dia. 28.5mm	235×100×29	10	247028
Bits ⊖6, ⊕2, T8H, T10H, T15H, T20H, T25H, T27H, T30H, T40H×25.4mm			

Accessories Bit belt holder

TORX® is a registered trademark of Acument TM Intellectual Properties, LLC (USA). VESSEL has a manufacturing license in Japan and selling same to the world.



**No. TD-800 "FAMIDORA 8" Screwdriver 8-Piece Set**

- Ergonomic handle that fits in the palm of the hand.
- Color-coded interchangeable driver blades.
- Provided with a screwdriver stand, which is convenient for storage.



Set content		Package size (mm)	Inner Ctn.	Outer Ctn.	EDP No.
Handle	length 100mm dia. 29.5mm				
Driver blades	Φ0, Φ1, Φ2, Φ2.5, Φ4, Φ6, Awl, Pin extractor×128mm				

**No. TD-410 "FAMIDORA" Reversible Blade Screwdriver**

- Ergonomic handle that fits in the palm of the hand.
- Fully hardened shank. Tough tip.



Set content		Package size (mm)	Inner Ctn.	Outer Ctn.	EDP No.
Handle	length 101.5mm dia. 29mm				
Driver blades	Φ2 / Φ6×150mm				

**One point**

**Features of the FAMIDORA series  
Small handle / Big handle**

Compact design useful as a standing set in households, offices, stores, etc.



Small handle

Big handle

Without big handle, the screwdriver can be used.



In a drawer

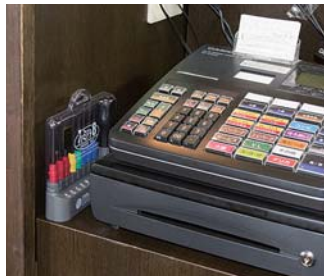

In a gap beside a cash register



For mounting hardware



For fastening a sign with screws

**No. TD-808 "FAMIDORA W8" Screwdriver Set**

- Ergonomic handle that fits in the palm of the hand.
- Reversible blades. Each blade has 2-sized ends.
- Fully hardened alloy steel shank. ● Provided with a transparent case.



Set content		Package size (mm)	Inner Ctn.	Outer Ctn.	EDP No.
Handle	length 100mm dia. 29.5mm				
Driver blades	Φ0/Φ2.5, Φ1/Φ4, Φ2/Φ6, Awl, Pin extractor×120mm				

**No. TD-2100 "Dual-Tone" Screwdriver Set NEW**

- Set of a handle and interchangeable blades, convenient for repair/disassembly of electric goods, toys, and equipment instruments.
- Octagonal grip effectively transmitting fastening force; made of polypropylene, oil and chemical resistant.
- Blades have a thin non-electrolytic plating layer and fits screws.
- Magnetized tip catching screws. ● Provided with a handy bag.



Set content		Package size (mm)	Inner Ctn.	EDP No.
Handle	length 100mm dia. 30mm			
Driver blades	Φ1, Φ2, Φ4, Φ6×120mm			

HAND TOOLS

BITS & SOCKETS

ELECTRIC TOOLS

AIR TOOLS

STATIC SOLUTIONS

GASOLINE ENGINE TOOLS

No. 550

# "SEPADORA" Screwdriver



Environmentally friendly products with low environmental impacts are desired in corporate activities.

All are ecological when held by hand.



Elastomer wrapping the grip holds the shank.



**No. 550**  
**"SEPADORA"**  
**Screwdriver**

Eco screwdrivers of the special manufacturing process that enables the shank and the handle to be separated.

The ergonomic grip designed in the motif of a leaf is superior in tightening force.

**⚠ Caution (SEPADORA)**

- Eco screwdrivers are not tang-thru screwdrivers; hitting a screwdriver with a hammer disables the shank from being pulled out or causes it to be deformed or broken.

※ This is for illustrative purpose.



**No. 550 "SEPADORA" Screwdriver PAT.**

- Shank and grip are separable. Sort and recycle.
- Wavy octagonal grip fits your palm and transmits driving torque effectively.



← See P21

No.550							Inner Ctn.	Outer Ctn.	EDP No.
⊖ 5.5 × 75	5.5	0.8	75	5.0	30.0	175	6	120	121601
⊖ 6 × 100	6.0	0.9	100	6.0	33.5	210	6	60	121602
⊖ 8 × 150	8.0	1.1	150	8.0	36.0	275	6	60	121603
⊕ 1 × 75	⊕No.1	75	5.0	30.0	175		6	120	121611
⊕ 2 × 100	⊕No.2	100	6.0	33.5	210		6	60	121612
⊕ 2 × 150	⊕No.2	150	6.0	33.5	260		6	60	121613
⊕ 3 × 150	⊕No.3	150	8.0	36.0	275		6	60	121616

**No. 590 "SEPADORA" Screwdriver (Precision Type) PAT.**

- Shank and grip are separable. Sort and recycle.
- Wavy octagonal grip fits your palm and transmits driving torque effectively.
- Special grip with a clip.
- Thin shank screwdriver. Ideal for screw tightening in precision fields.
- ※ ⊕00×50 is with a fully black oxide finish shank.



No.590							Inner Ctn.	Outer Ctn.	EDP No.
⊖ 2.5 × 50	2.5	0.35	50	3.0	15.4	99	24	480	121671
⊖ 2.5 × 75	2.5	0.35	75	3.0	15.4	124	24	480	121672
⊖ 2.5 × 100	2.5	0.35	100	3.0	15.4	149	24	480	121673
⊕ 00 × 50	⊕No.00	50	3.0	15.4	99		24	480	121674
⊕ 0 × 75	⊕No.0	75	3.0	15.4	124		24	480	121675

**No. 560 "SEPADORA" Screwdriver (Thin Shank Type) PAT.**

- Shank and grip are separable. Sort and recycle.
- Wavy octagonal grip fits your palm and transmits driving torque effectively.
- Thin shank screwdriver. Ideal for screw tightening in narrow spaces.



No.560							Inner Ctn.	Outer Ctn.	EDP No.
⊖ 4 × 75	4.0	0.5	75	4.0	19.8	153	12	240	121632
⊖ 4 × 100	4.0	0.5	100	4.0	19.8	178	12	240	121633
⊖ 4 × 150	4.0	0.5	150	4.0	19.8	228	12	240	121634
⊖ 4 × 200	4.0	0.5	200	4.0	19.8	278	12	240	121635
⊕ 0 × 75	⊕No.0	75	4.0	19.8	153		12	240	121642
⊕ 1 × 100	⊕No.1	100	4.0	19.8	178		12	240	121647
⊕ 2 × 150	⊕No.2	150	4.0	19.8	228		12	240	121651

**No. 570 "SEPADORA" Screwdriver (Stubby Type) PAT.**

- Shank and grip are separable. Sort and recycle.
- Wavy octagonal grip fits your palm and transmits driving torque effectively.
- Ideal for working in cramped places.



No.570							Inner Ctn.	Outer Ctn.	EDP No.
⊖ 6 × 25	6.0	0.9	25	6.0	45	50	12	240	121661
⊕ 1 × 25	⊕No.1	25	6.0	45	50		12	240	121662
⊕ 2 × 25	⊕No.2	25	6.0	45	50		12	240	121663

One point

Concave octagonal grip

Dents and projections of the waves fit into your palm to transmit the torque securely.

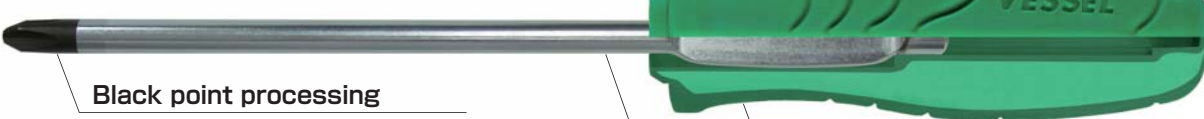

Tip shape is shown on the grip end

Black point processing

High precision finish, unaffected by plate thickness

Rust-proof chrome plating

Elastomer grip

The elastomer resin coating on the surface is slip-proof and fits into your palm

HAND TOOLS

BITS & SOCKETS

ELECTRIC TOOLS

AIR TOOLS

STATIC SOLUTIONS

GASOLINE ENGINE TOOLS

## No.500 ECO VALUE Screwdriver

- Robust looking black hard grip.
- Wavy octagonal grip fits your palm and transmits driving torque effectively.
- Champagne gold plating, keeping the precise tip quality.



No.500							Inner Ctn.	Outer Ctn.	EDP No.
⊖ 5.5 × 75	5.5	0.8	75	5.0	30.0	175	6	120	121751
⊖ 6 × 100	6.0	0.9	100	6.0	33.5	210	6	60	121752
⊖ 8 × 150	8.0	1.1	150	8.0	36.0	275	6	60	121753
⊕ 1 × 75	⊕No.1	75	5.0	30.0	175		6	120	121761
⊕ 2 × 100	⊕No.2	100	6.0	33.5	210		6	60	121762
⊕ 3 × 150	⊕No.3	150	8.0	36.0	275		6	60	121766

※The shank is not separable.

## No.510 ECO VALUE Screwdriver

- Robust looking black hard grip.
- Wavy octagonal grip fits your palm and transmits driving torque effectively.
- Thin shank screwdriver. Ideal for screw tightening in narrow spaces.
- Champagne gold plating, keeping the precise tip quality.



No.510							Inner Ctn.	Outer Ctn.	EDP No.
⊖ 4 × 75	4.0	0.45	75	4.0	19.8	153	12	240	121782
⊖ 4 × 100	4.0	0.45	100	4.0	19.8	178	12	240	121783
⊕ 0 × 75	⊕No.0	75	4.0	19.8	153		12	240	121792
⊕ 1 × 100	⊕No.1	100	4.0	19.8	178		12	240	121797

※The shank is not separable.

## No.540 ECO VALUE Screwdriver (Precision Type)

- Robust looking black hard grip.
- Wavy octagonal grip fits your palm and transmits driving torque effectively.
- Special grip with a clip.
- Thin shank screwdriver. Ideal for screw tightening in precision fields.
- Champagne gold plating, keeping the precise tip quality.



No.540							Inner Ctn.	Outer Ctn.	EDP No.
⊖ 2.5 × 50	2.5	0.35	50	3.0	15.4	99	24	480	121821
⊕ 00 × 50	⊕No.00	50	3.0	15.4	99		24	480	121824
⊕ 0 × 75	⊕No.0	75	3.0	15.4	124		24	480	121825

※The shank is not separable.

## No.520 ECO VALUE Screwdriver (Stubby Type)

- Robust looking black hard grip.
- Wavy octagonal grip fits your palm and transmits driving torque effectively.
- Ideal for working in cramped spaces.
- Champagne gold plating, keeping the precise tip quality.



No.520							Inner Ctn.	Outer Ctn.	EDP No.
⊖ 6 × 25	6.0	0.9	25	6.0	45	50	12	240	121811
⊕ 1 × 25	⊕No.1	25	6.0	45	50		12	240	121812
⊕ 2 × 25	⊕No.2	25	6.0	45	50		12	240	121813

※The shank is not separable.

## No.460NT-9S ECOSOFT T-bar screwdriver (w/socket bit set)

- The ergonomic grip fits comfortably in your hand. T-shaped handle transmits high torque without applying too much force by your hand.
- Ball-lock type holds a socket assuredly. Hex drive 6.35mm.



Set content		Package size (mm)	Inner Ctn.	Outer Ctn.	EDP No.
Body	length 165.5mm dia. 100mm				
Socket bits	A/F5, A/F5.5, A/F6, A/F7, A/F8, A/F9, A/F10, A/F12, A/F13 ×26.5mm	235×120×30	5	30	121891
Accessories	Socket bit holder				

※The shank is not separable.



No. 100

# Powerful Tang-Thru Screwdriver



Luxurious furniture finish coating on the large handle, which fits more comfortably in your hand the more you use it.

Its better usability compared to plastic handles attracts support from many professional users.



**No. 100**

## Powerful Tang-Thru Screwdriver

Especially large, heavy-duty end cap. An especially large end cap efficiently delivers the shock of the hammer blow.

When tapped with a hammer, and adjusting the force of the tapping to the condition of the material concerned, this screwdriver can be used effectively to loosen stripped or rusted screws.

※This is for illustrative purpose.

HAND TOOLS

BITS & SOCKETS

ELECTRIC TOOLS

AIR TOOLS

STATIC SOLUTIONS

GASOLINE ENGINE TOOLS



### No. 100 Powerful Tang-Thru Screwdriver

- Wooden handle and Tang-Thru shank with thick end cap.
- Large and long grip comfortable to hold.
- Black point tip.



← See P24

No.100	Tip Dimensions (mm)						Inner Ctn.	Outer Ctn.	EDP No.
	Tip Dia.	Tip Len.	Shank Dia.	Shank Len.	Tip Dia.	Tip Len.			
⊖ 5.5 × 75	5.5	0.8	75	5.8	27.0	182	6	120	111051
⊖ 6 × 100	6.0	0.9	100	6.4	30.5	223	6	120	111052
⊖ 6 × 300	6.0	0.9	300	6.4	30.5	423	6	60	111061
⊖ 8 × 150	8.0	1.1	150	8.0	34.0	294	6	120	111053
⊕ 1 × 75	⊕No.1	75	5.8	27.0	182		6	120	111054
⊕ 2 × 100	⊕No.2	100	6.4	30.5	223		6	120	111055
⊕ 2 × 300	⊕No.2	300	6.4	30.5	423		6	60	111066
⊕ 3 × 150	⊕No.3	150	8.0	34.0	294		6	120	111056

### No. 110 Wooden Handle Socket Driver

- For fastening and loosening hexagon bolts and nuts.
- Tip is made of specially treated steel to enhance wear resistance.



No.110	Tip Dimensions (mm)						Inner Ctn.	Outer Ctn.	EDP No.	
	Tip Dia.	Tip Len.	Shank Dia.	Shank Len.	Tip Dia.	Tip Len.				
A/F 5 × 115	5	8	18	115	5	23	210	12	120	113002
A/F 6 × 115	6	9	18	115	5.5	25	220	12	240	113004
A/F 9 × 125	9	12.7	20	125	6.3	28	250	12	120	113007
A/F 11 × 125	11	15	20	125	6.3	28	250	12	120	113009
A/F 12 × 150	12	17	20	150	8	33	292	6	—	113010
A/F 14 × 150	14	19	22	150	8	33	292	6	—	113012
A/F 17 × 150	17	23	22	150	9	35	313	6	—	113013

### No. 310 Wooden Handle standard Shank Screwdriver

- Widely-used standard wooden handle screwdriver.
- Mahogany colored handle. Easy-to-grip texture and shape.
- Shot blasting tip.



No.310	Tip Dimensions (mm)						Inner Ctn.	Outer Ctn.	EDP No.
	Tip Dia.	Tip Len.	Shank Dia.	Shank Len.	Tip Dia.	Tip Len.			
⊖ 5.5 × 75	5.5	0.8	75	5.5	25	181	12	120	111102
⊖ 8 × 150	8	1.1	150	8	33	292	6	120	111105
⊕ 2 × 100	⊕No.2	100	6.3	28	225		12	240	111111

### No. 350 Wooden Handle Tang-Thru Screwdriver

- Widely-used standard wooden handle screwdriver.
- Wooden handle and Tang-Thru shank with large end cap.
- Shot blasting tip.



No.350	Tip Dimensions (mm)						Inner Ctn.	Outer Ctn.	EDP No.
	Tip Dia.	Tip Len.	Shank Dia.	Shank Len.	Tip Dia.	Tip Len.			
⊖ 4.5 × 50	4.5	0.6	50	5.0	25	153	12	120	111001
⊖ 5.5 × 75	5.5	0.8	75	5.5	25	178	12	120	111002
⊖ 6 × 100	6.0	0.9	100	6.3	28	218	12	240	111003
⊖ 7 × 125	7.0	0.9	125	7.0	33	258	6	120	111004
⊖ 8 × 150	8.0	1.1	150	8.0	33	283	6	120	111005
⊖ 9 × 200	9.0	1.2	200	9.0	36	355	6	60	111006
⊖ 10 × 300	10.0	1.2	300	9.0	36	455	6	60	111008
⊕ 0 × 75	⊕No.0	75	5.0	25	178		12	120	111009
⊕ 1 × 75	⊕No.1	75	5.0	25	178		12	120	111010
⊕ 2 × 100	⊕No.2	100	6.3	28	218		12	240	111011
⊕ 3 × 150	⊕No.3	150	8.0	33	283		6	120	111012
⊕ 4 × 200	⊕No.4	200	9.0	36	355		6	60	111013

### No. 350 Wooden Handle Tang-Thru Screwdriver (Long Shank Type)

- Wooden handle and Tang-Thru shank.
- Long shank for fastening in a hard-to-reach space.

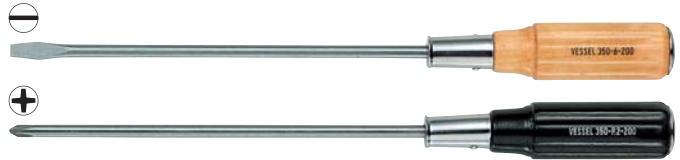

No.350	Tip Dimensions (mm)						Inner Ctn.	Outer Ctn.	EDP No.
	Tip Dia.	Tip Len.	Shank Dia.	Shank Len.	Tip Dia.	Tip Len.			
⊖ 6 × 200	6.0	0.9	200	6.3	28	320	12	120	111018
⊖ 6 × 250	6.0	0.9	250	6.3	28	370	12	120	111019
⊖ 6 × 300	6.0	0.9	300	6.3	28	420	12	120	111020
⊕ 2 × 200	⊕No.2	200	6.3	28	320		12	120	111024
⊕ 2 × 250	⊕No.2	250	6.3	28	370		12	120	111025
⊕ 2 × 300	⊕No.2	300	6.3	28	420		12	120	111026

### No. 30 "SPLIT" Handle Screwdriver

- Joined Tang-Thru shank and handle. Super strong type.

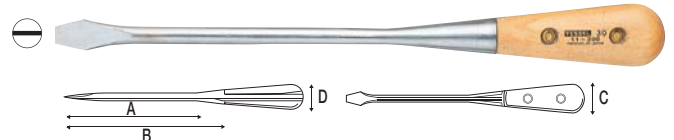

No.30	Tip Dimensions (mm)						Inner Ctn.	Outer Ctn.	EDP No.		
	Tip Dia.	Tip Len.	Shank Dia.	Shank Len.	Tip Dia.	Tip Len.					
⊖ 9.5 × 150	9.5	1.2	9.5	145	190	35	29	285	6	120	113101
⊖ 11 × 200	11	1.2	11	195	255	38	32	360	6	120	113102



No. 300

# Wood-Compo Screwdriver



Maintenance of cars, motorbikes and machines always involves oils. Wood-compo screwdriver's coarse wood powder on the grip surface stops the oil flow against the tightening torque, producing an outstanding non-slip grip effect.

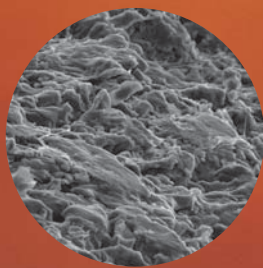

A D V A N C E D

## NON-SLIP

T E C H N O L O G Y

**No. 300**

### Wood-Compo Screwdriver

The grip part is made by unique mold injection technique for "wood resin" which is a compound of wood powder and plastic. Wood powder is the main material, realizing texture and feeling to fit comfortably in your hand like those made of natural wood.

※ This is for illustrative purpose.

HAND TOOLS

BITS & SOCKETS

ELECTRIC TOOLS



AIR TOOLS

STATIC SOLUTIONS

GASOLINE ENGINE TOOLS





### No. 300 Wood-Compo Screwdriver NEW PAT.

- Extraordinary non-slip grip; Secure working efficiency even with oily hands.   
- Wood-composite resin, reproducing the natural material texture.
- Rust-resistant black chrome plating shank.



No.300							Inner Ctn.	Outer Ctn.	EDP No.	
⊖ 5.5x	75	5.5	0.8	75	5.5	30	182	6	120	120021
⊖ 6x	100	6.0	0.9	100	6.4	32	215	6	120	120022
⊖ 6x	150	6.0	0.9	150	6.4	32	265	6	120	120027
⊖ 8x	150	8.0	1.1	150	8.0	35	275	6	120	120023
⊕ 1x	75	⊕No.1	75	5.5	30	182	6	120	120024	
⊕ 2x	100	⊕No.2	100	6.4	32	215	6	120	120025	
⊕ 2x	150	⊕No.2	150	6.4	32	265	6	120	120029	
⊕ 3x	150	⊕No.3	150	8.0	35	275	6	120	120026	



### No. B-330 Wood-Compo Tang-Thru Screwdriver NEW PAT.

- Extraordinary non-slip grip; Secure working efficiency even with oily hands.   
- Tang-thru type, which can be tapped by a hammer. With star-shaped nut.
- Rust-resistant black chrome plating shank.



No.B-330							Inner Ctn.	Outer Ctn.	EDP No.	
⊖ 5.5x	75	5.5	0.8	75	5.5	30	183	6	120	120041
⊖ 6x	100	6.0	0.9	100	6.4	32	217	6	120	120042
⊖ 6x	150	6.0	0.9	150	6.4	32	267	6	60	120043
⊖ 8x	150	8.0	1.1	150	8.0	35	277	6	60	120044
⊕ 1x	75	⊕No.1	75	5.5	30	183	6	120	120045	
⊕ 2x	100	⊕No.2	100	6.4	32	217	6	120	120046	
⊕ 2x	150	⊕No.2	150	6.4	32	267	6	60	120047	
⊕ 3x	150	⊕No.3	150	8.0	35	277	6	60	120048	



### No. B-300 Wood-Compo S/D (w/hanging card) NEW PAT.

- Extraordinary non-slip grip; Secure working efficiency even with oily hands.   
- Wood-composite resin, reproducing the natural material texture.
- Rust-resistant black chrome plating shank.



No.B-300							Inner Ctn.	Outer Ctn.	EDP No.	
⊖ 5.5x	75	5.5	0.8	75	5.5	30	183	6	120	120071
⊖ 6x	100	6.0	0.9	100	6.4	32	217	6	120	120072
⊖ 6x	150	6.0	0.9	150	6.4	32	267	6	60	120073
⊖ 8x	150	8.0	1.1	150	8.0	35	277	6	60	120074
⊕ 1x	75	⊕No.1	75	5.5	30	183	6	120	120075	
⊕ 2x	100	⊕No.2	100	6.4	32	217	6	120	120076	
⊕ 2x	150	⊕No.2	150	6.4	32	267	6	60	120077	
⊕ 3x	150	⊕No.3	150	8.0	35	277	6	60	120078	

### No. 320 Wood-Compo Screwdriver (Stubby Type) NEW PAT.

- Stubby type, which is convenient for tightening screws in cramped spaces.   
- Wood-composite resin, reproducing the natural material texture.
- Rust-resistant black chrome plating shank.



No.320							Inner Ctn.	Outer Ctn.	EDP No.	
⊖ 6x	15	6.0	0.9	15	6.0	35	68	6	120	120035
⊕ 2x	15	⊕No.2	15	6.0	35	68	6	120	120037	

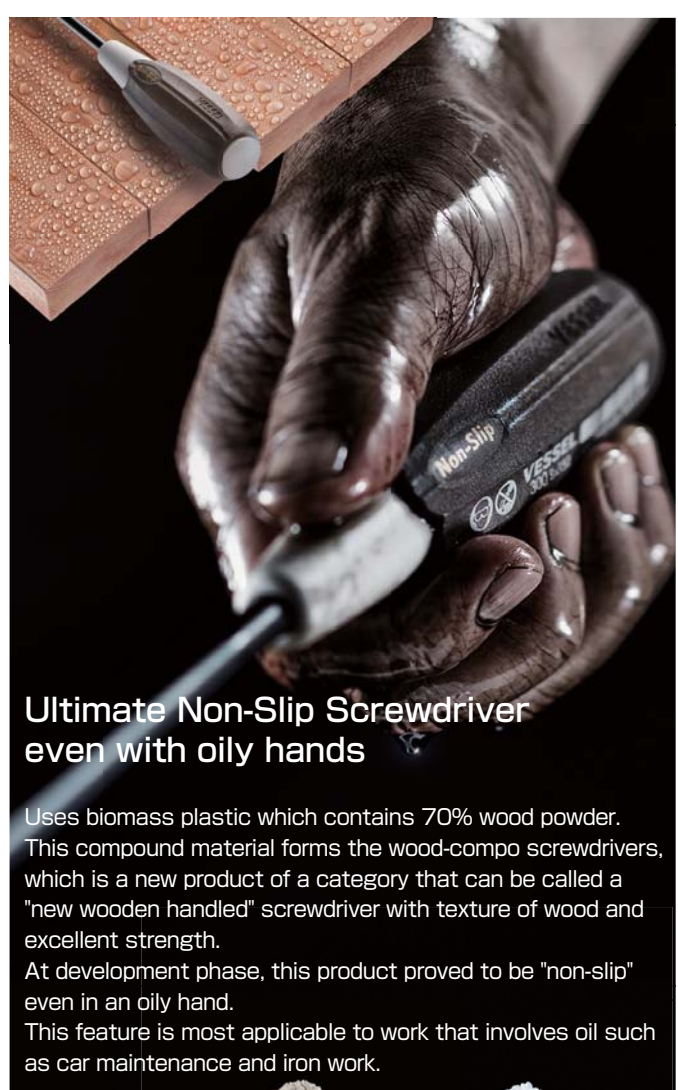

**Ultimate Non-Slip Screwdriver even with oily hands**

Uses biomass plastic which contains 70% wood powder. This compound material forms the wood-compo screwdrivers, which is a new product of a category that can be called a "new wooden handled" screwdriver with texture of wood and excellent strength. At development phase, this product proved to be "non-slip" even in an oily hand. This feature is most applicable to work that involves oil such as car maintenance and iron work.



**One point**



**No. B-340TX**

**Wood-Compo TORX Screwdriver NEW PAT.**



- Extraordinary non-slip grip; Secures working efficiency even with oily hands. Wood-composite resin, reproducing the natural material texture.
- Non-electrolytic plating, keeping the precise tip quality.
- Also good for tamper-proof TORX screws.



No.B-340TX	T	W	H	L	SH	Inner (mm)	Outer (mm)	JAN (4907587)
T10H	2.72	80	5.5	30	188	6	120	120081
T15H	3.26	80	5.5	30	188	6	120	120082
T20H	3.84	120	5.5	30	228	6	120	120083
T25H	4.40	120	6.4	32	236	6	60	120084
T27H	4.96	120	6.4	32	236	6	60	120085
T30H	5.49	120	8.0	35	246	6	60	120086
T40H	6.60	120	8.0	35	246	6	60	120087

TORX® is a registered trademark of Acument TM Intellectual Properties, LLC (USA). VESSEL has a manufacturing license in Japan and selling same to the world.

**No. B-380NT**

**Wood-Compo Socket Screwdriver NEW PAT.**



- Extraordinary non-slip grip; Secures working efficiency even with oily hands. Wood-composite resin, reproducing the natural material texture.
- Black oxide plated socket.
- Rust resistant chrome plating. Hexagonal shank for fastening with a wrench.

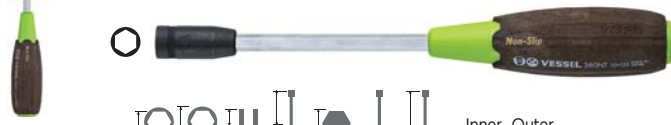

No.B-380NT	W	H	L	SH	SH	SH	Inner Ctn. (mm)	Outer Ctn. (mm)	EDP No.
A/F 5 ×125	5	8	18	125	5.0	30.0	224	60	120091
A/F 5.5×125	5.5	9	18	125	5.0	30.0	224	60	120092
A/F 7 ×125	7	10	18	125	5.0	30.0	224	60	120093
A/F 8 ×125	8	12	20	125	5.0	32.0	233	60	120094
A/F 10×125	10	15	20	125	7.0	32.0	233	60	120095
A/F 12×150	12	17	20	125	7.0	32.0	233	60	120096
A/F 13×150	13	19	22	125	7.0	32.0	233	60	120097
A/F 14×150	14	19	22	125	7.0	32.0	233	60	120098

**No. B-370 Non-slip Tang-Thru Screwdrivers**

- Unique Non-Slip finish that prevents slipping even if oil adheres on the grip.



- Tang-thru type with a large nut. Good for heavy duty work.
- The end of the handle has a color ring facilitates to distinguish the tip difference at a glance.



No.B-370	W	H	L	SH	SH	SH	Inner Ctn. (mm)	Outer Ctn. (mm)	EDP No.
⊖ 5.5× 75	5.5	0.8	75	5.5	27.4	183	6	60	267590
⊖ 6 × 100	6.0	0.9	100	6.4	30.7	226	6	60	267591
⊖ 8 × 150	8.0	1.1	150	8.0	36.2	290	6	60	267592
⊕ 1 × 75	⊕No.1	75	5.5	27.4	183	6	60	267593	
⊕ 2 × 100	⊕No.2	100	6.4	30.7	226	6	60	267594	
⊕ 3 × 150	⊕No.3	150	8.0	36.2	290	6	60	267595	

HAND TOOLS

BITS & SOCKETS

ELECTRIC TOOLS

AIR TOOLS

STATIC SOLUTIONS

GASOLINE ENGINE TOOLS

No. 990

# G-grip Screwdriver



This precision screwdriver is perfect for the delicate screw tightening operations of precision work. Our high-precision, tip process conforms to JIS and JICIA standards. The ergonomic grips employed enable a smoother torque transfer.



**No. 990**

## G-grip Screwdriver

Quick-turning screwdriver, taking advantage of the gravity force. The perfect shape for high-precision work. The weight of the internal steel ball freely rotates the cap in the palm of the hand to provide the optimum grip position.

HAND TOOLS

BITS & SOCKETS

ELECTRIC TOOLS

AIR TOOLS

STATIC SOLUTIONS

GASOLINE ENGINE TOOLS

※The photograph is an image.



**No. 990 G-grip Screwdriver PAT.**

- The weight of the steel ball keeps the end cap in an optimum position for a grip.
  - Black point tip, fitting well screws.
  - Slotted tip is cut straight.

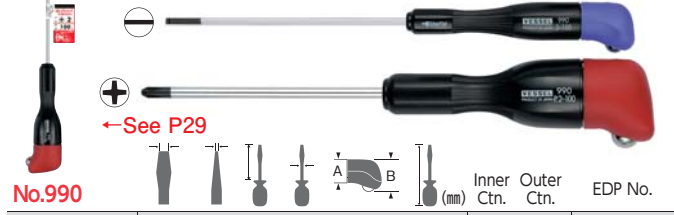

No.990	Inner Ctn.	Outer Ctn.	EDP No.
1.8 × 50	1.8 0.25 50 2.5 16 21 148	12 240	125901
2.5 × 75	2.5 0.3 75 2.5 16 21 173	12 240	125902
3 × 100	3 0.5 100 3.0 16 21 198	12 240	125903
4 × 100	4 0.6 100 4.0 16 21 198	12 240	125904
5 × 100	5 0.8 100 5.0 30 38 215	6 60	125905
00 × 75	⊕No.00 75 2.5 16 21 173	12 240	125911
0 × 100	⊕No.0 100 3.0 16 21 198	12 240	125912
1 × 100	⊕No.1 100 3.0 30 38 215	6 60	125913
2 × 100	⊕No.2 100 5.0 30 38 215	6 60	125914

**No. 9902/9903 3-Piece Micro Screwdriver Set**

- 2 types recommended to precision fields.
- Set of frequently used sizes.
- For adjustment and repair of precision device, electric device, glasses, watches, etc.



Model No.	Set content	Package size (mm)	Inner Ctn.	Outer Ctn.	EDP No.
9902	No.9900 ⊕00×75, ⊕0×100, ⊖1.8×50	235×70×15	5	30	125636
9903	No.9900 ⊕00×75, ⊖2.5×75, ⊖3×100	235×70×15	5	30	125637

**No. 990TX G-grip TORX Screwdriver PAT.**

- The weight of the steel ball keeps the end cap in an optimum position for a grip.
  - A special precision spring is welded to the tip by laser, enabling the screwdriver to catch a TORX screw firmly by spring action.

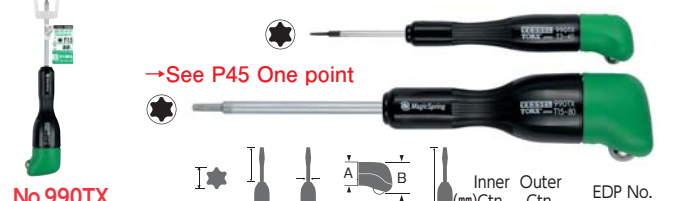

No.990TX	Inner Ctn.	Outer Ctn.	EDP No.
T3 × 40	1.13 40 2.5 16 21 138	12 240	125921
T5 × 40	1.42 40 2.5 16 21 138	12 240	125923
MagicSpring T6 × 40	1.69 40 2.5 16 21 138	12 240	125924
MagicSpring T8 × 40	2.3 40 2.5 16 21 138	12 240	125926
MagicSpring T9 × 40	2.48 40 4.0 16 21 138	12 240	125927
MagicSpring T10 × 80	2.72 80 4.0 30 38 195	6 60	125928
MagicSpring T15 × 80	3.26 80 5.5 30 38 195	6 60	125929
MagicSpring T20 × 80	3.84 80 5.5 30 38 195	6 60	125930

TORX® is a registered trademark of Acument™ Intellectual Properties, LLC (USA). VESSEL has a manufacturing license in Japan and selling same to the world.

One point

Features of the precision tip

**Precisely-finished tip-end good for minuscule screws No.990 / No.9900**

00 / 0

**A deep recessed area can also be accessed by the thin shank!**

6mm hole, M3 round head screw, and screw head dia. of φ5.5 mm

1 / 2

**Two-step flat shape, enabling the tip to fit into a screw No.990**

1.8 / 2.5 / 3 / 4 / 5

StepFlat

**Catches a TORX screw A special-shape spring is welded to the tip by laser. No.990TX**

T6 / T8 / T9 / T10 / T15 / T20

MagicSpring

TORX® is a registered trademark of Acument™ Intellectual Properties, LLC (USA). VESSEL has a manufacturing license in Japan and selling same to the world.

HAND TOOLS

BITS & SOCKETS

ELECTRIC TOOLS

AIR TOOLS

STATIC SOLUTIONS

GASOLINE ENGINE TOOLS

### No. TD-51 Precision Micro Screwdriver

- The main body is made of stainless steel (the end cap is made of resin).
- For assembly, repair, and disassembly of precision devices, cameras, watches, glasses, etc.

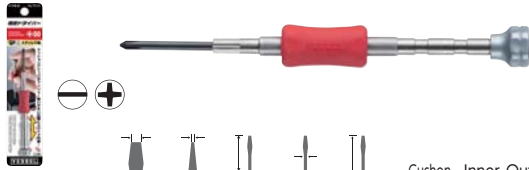

No. TD-51	Tip	Length (mm)	Cushion Grip color	Inner Ctn.	Outer Ctn.	EDP No.
⊖0.7	0.7 0.15 10	0.7 90	Purple	10	100	251350
⊖0.9	0.9 0.2 10	0.9 90	Green	10	100	251351
⊖1.2	1.2 0.25 10	1.2 90	Blue	10	100	251352
⊖1.8	1.8 0.3 20	1.8 100	Black	10	100	251353
⊖2.3	2.3 0.35 22	2.3 102	Purple	10	100	251354
⊖3.0	3.0 0.4 26	3.0 106	Red	10	100	251355
⊖3.5	3.5 0.5 28	3.5 108	Yellow	10	100	251356
⊕00	⊕No.00 24 2.4 104		Red	10	100	251357
⊕0	⊕No.0 26 3.0 106		Yellow	10	100	251358
⊕1	⊕No.1 26 3.0 106		Green	10	100	251359

Package size...160×35×14mm

### No. TD-52 Precision Nutdriver

- The main body is made of stainless steel (the end cap is made of resin).
- For assembly, repair, and disassembly of precision devices, spacer, toys, etc.

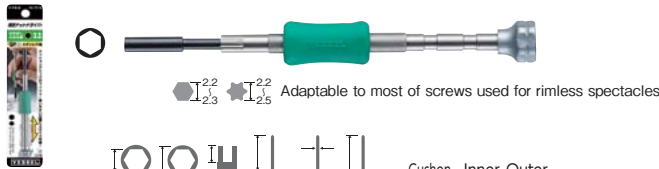

No. TD-52	Tip	Length (mm)	Cushion Grip color	Inner Ctn.	Outer Ctn.	EDP No.
2.2	— 4.0 12 25 3.0 105	105	Green	10	100	251361
A/F 3.0	3.0 5.0 7 25 3.0 105	105	Blue	10	100	251362
A/F 4.0	4.0 6.0 9 25 3.0 105	105	Black	10	100	251363
A/F 4.5	4.5 6.5 10 25 3.0 105	105	Purple	10	100	251364
A/F 5.0	5.0 7.0 11 25 3.0 105	105	Red	10	100	251365
A/F 5.5	5.5 8.0 10 25 3.0 105	105	Yellow	10	100	251366

Package size...160×35×14mm

### No. TD-53 Precision Hex. Driver

- The main body is made of stainless steel (the end cap is made of resin).
- For assembly, repair, and disassembly of precision devices, toys, etc.



No. TD-53	Tip	Length (mm)	Cushion Grip color	Inner Ctn.	Outer Ctn.	EDP No.
H 0.89	0.89 18 98	98	Green	10	100	251371
H 1.27	1.27 18 98	98	Blue	10	100	251372
H 1.5	1.5 18 98	98	Black	10	100	251373
H 2.0	2.0 24 104	104	Purple	10	100	251374
H 2.5	2.5 24 104	104	Yellow	10	100	251375

Package size...160×35×14mm

### No. TD-54 Watch Band Pin Punch

- The main body is made of stainless steel (the end cap is made of resin).
- For adjustment of the watch band.

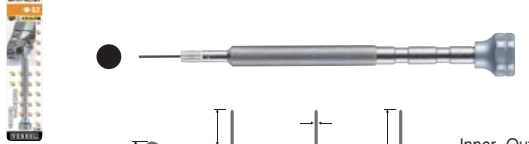

No. TD-54	Tip	Length (mm)	Inner Ctn.	Outer Ctn.	EDP No.
0.7	0.7 10 0.7 90	90	10	100	251380

Package size...160×35×14mm

### No. TD-55/56/57/58 Precision Screwdriver Set

- The main body is made of stainless steel (the end cap is made of resin).
- Provided in a portable transparent case.



Model No.	Model Name	Set content	Package size (mm)	Inner Ctn.	EDP No.
TD-55	Precision Screwdriver Set	⊖0.9, ⊖1.2, ⊖1.8, ⊖2.3, ⊖3.0, ⊖3.5	140×86×20	10	251381
TD-56	Precision Screwdriver Set	⊖0.9, ⊖1.2, ⊖1.8, ⊖2.3, ⊕00, ⊕0	140×86×20	10	251382
TD-57	Precision Nut driver Set	2.2, ⊖3.0, ⊖4.0, ⊖4.5, ⊖5.0, ⊖5.5	140×86×20	10	251383
TD-58	Precision Hex.driver Set	●0.89, ●1.27, ●1.5, ●2.0, ●2.5, ⊕00	140×86×20	10	251384

### No. 9000 Ceramic Adjusters

- Uses a zirconia ceramics tip, non-inductive magnetic substance.
- Optimum for coil and trimmer adjustments.
- For the adjustment of electronic parts, such as audio instruments, computers, telecommunication devices, electronics components, and electric components.

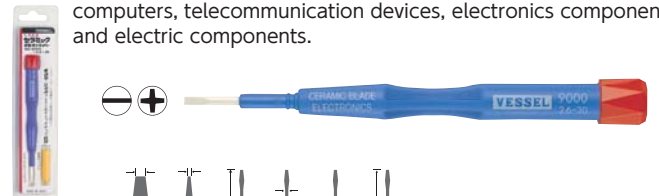

No. 9000	Tip	Length (mm)	End cap color	Inner Ctn.	Outer Ctn.	EDP No.
⊖0.9×30	0.9 0.4 30 1.8 10 125	125	Green	10	60	125641
⊖1.3×30	1.3 0.4 30 1.8 10 125	125	White	10	60	125642
⊖1.8×30	1.8 0.4 30 1.8 10 125	125	Yellow	10	60	125643
⊖2.6×30	2.6 0.4 30 2.6 10 125	125	Red	10	60	125644
⊖3.4×15	3.4 0.5 15 3.4 10 115	115	Black	10	60	125645
⊕0 ×30	⊕No.0 30 2.6 10 125	125	Navy blue	10	60	125646
⊕1.7×30	⊕Width1.7 30 2.6 10 125	125	Lilac	10	60	125647

Package size...190×45×14mm

### No. CA Individual Ceramic Blades / Ceramic Blade Adapters

- Blade for automatic adjuster. ●Made of zirconia ceramics, offering high durability.
- For the adjustment of electronic parts, such as audio instruments, computers, telecommunication devices and electronic components.

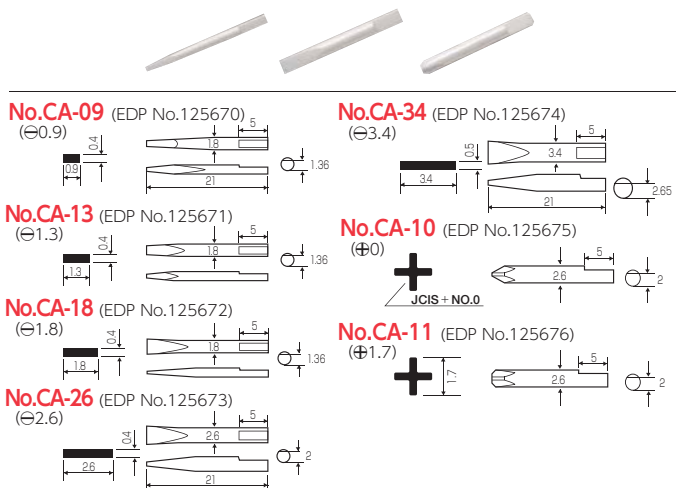

<b>No. CA-09</b> (EDP No.125670) (⊖0.9)	<b>No. CA-34</b> (EDP No.125674) (⊖3.4)
<b>No. CA-13</b> (EDP No.125671) (⊖1.3)	<b>No. CA-10</b> (EDP No.125675) (⊕0)
<b>No. CA-18</b> (EDP No.125672) (⊖1.8)	<b>No. CA-11</b> (EDP No.125676) (⊕1.7)
<b>No. CA-26</b> (EDP No.125673) (⊖2.6)	

Inner Ctn.:10pcs



# No. TD-6800 Series Ratchet Screwdriver



This functionally enhanced screwdriver enables screw tightening by simple repeated wrist movements.

Improved gear strength combined with our unique ratchet design makes these screwdrivers suitable for the most strenuous tightening jobs.

HAND TOOLS

BITS & SOCKETS

ELECTRIC TOOLS

AIR TOOLS

STATIC SOLUTIONS

GASOLINE ENGINE TOOLS



## No. TD-6804MG Ratchet Screwdriver

Newly developed 72 gear ratchet realizes smooth rotation. You can work by one hand, without grasping over again.

### Ratchet series optimal for a confined area

	Flexible	Plate Ratchet	Screw catcher	Stubby	Driver	Power
At a corner edge						
In a narrow area						
In a deep recessed area						
For torque retaining tightening						
	TD-6700FX-4	TD-74/75/76/77/78/79 TD-70/71/72	TD-73MC TX-12MC	TD-6700W-23	TD-6800 Series	S-13
						TD-80 S-12/13 TD-81R/81G/81B



### No. TD-6804MG Ratchet Screwdriver (4-pc bit set) **NEW**

- Smoothly click feeling realized by rotating angle of 5° and 72 gears. High strength accomplished by 2 nails supporting the ratchet gear. It can be used for final tightening work.
- The handle is made out of oil-resistance cellulose acetate resin.
- Easy to carry around with cassette type bit storage inside the handle.
- Magnetic bits can be replaced with one-touch.
- Bit insertion part ●6.35mm.



Set content			
Body	length 177mm dia. 28.5mm		
Bits	⊕1, ⊕2, ⊕3, ⊖6 ×25.4mm		
Package size (mm)	Inner Ctn.	Outer Ctn.	EDP No.
235×80×29	5	30	247022

### No. TD-6808MG Ratchet Screwdriver (8-pc bit set) **NEW**

- Smoothly click feeling realized by rotating angle of 5° and 72 gears. High strength accomplished by 2 nails supporting the ratchet gear. It can be used for final tightening work.
- The handle is made out of oil-resistance cellulose acetate resin.
- Easy to carry around with cassette type bit storage inside the handle.
- Stores 8 types of bits including HEX bit. Magnetic bits can be replaced with one-touch.
- Bit insertion part ●6.35mm.



Set content			
Body	length 177mm dia. 28.5mm		
Bits	⊕1, ⊕2, ⊕3, ⊖6, H2.5, H3, H4, H5 ×25.4mm		
Package size (mm)	Inner Ctn.	Outer Ctn.	EDP No.
235×80×29	5	30	247023

### No. TD-6808TX Ratchet Screwdriver TORX (8-pc bit set) **NEW**

- Smoothly click feeling realized by rotating angle of 5° and 72 gears. High strength accomplished by 2 nails supporting the ratchet gear. It can be used for final tightening work.
- The handle is made out of oil-resistance cellulose acetate resin.
- Easy to carry around with cassette type bit storage inside the handle.
- Stores 8 types of bits including TORX bit. Magnetic bits can be replaced with one-touch.
- Bit insertion part ●6.35mm.



Set content			
Body	length 177mm dia. 28.5mm		
Bits	⊕2, ⊕3, T10H, T15H, T20H, T25H, T30H, T40H ×25.4mm		
Package size (mm)	Inner Ctn.	Outer Ctn.	EDP No.
235×80×29	5	30	247024

TORX® is a registered trademark of Acument TM Intellectual Properties, LLC (USA). VESSEL has a manufacturing license in Japan and selling same to the world.

### No. TD-6816MG Ratchet Screwdriver (16-pc bit set) **NEW**

- Smoothly click feeling realized by rotating angle of 5° and 72 gears. High strength accomplished by 2 nails supporting the ratchet gear. It can be used for final tightening work.
- The handle is made out of oil-resistance cellulose acetate resin.
- Easy to carry around with cassette type bit storage inside the handle.
- 16 types of bits to adapt to various types of work. Magnetic bits can be replaced with one-touch.
- Bit insertion part ●6.35mm.



Set content			
Body	length 177mm dia. 28.5mm		
Bits	⊕1, ⊕2, ⊕3, ⊖6, H2, H2.5, H3, H4, H5, T10H, T15H, T20H, T25H, T27H, T30H, T40H ×25.4mm		
Package size (mm)	Inner Ctn.	Outer Ctn.	EDP No.
235×90×29	5	30	247025

TORX® is a registered trademark of Acument TM Intellectual Properties, LLC (USA). VESSEL has a manufacturing license in Japan and selling same to the world.

### No. TD-6700W-23 Ratchet Stubby Screwdriver **NEW**

- Improves workability in cramped spaces! Stubby type that fits in your hand.
- Smoothly click feeling realized by rotating angle of 5° and 72 gears. High strength accomplished by 2 nails supporting the ratchet gear. It can be used for final tightening work.
- The handle is made out of oil-resistance cellulose acetate resin.
- Ball-lock bits can be replaced with one-touch.
- Bit insertion part ●6.35mm.



Set content			
Body	length 77mm	dia. 35mm	
Bits	⊕2 / ⊕3 × 35mm		
Package size (mm)	Inner Ctn.	Outer Ctn.	EDP No.
135×70×40	10	60	247026

### No. TD-6700FX-4 Ratchet Stubby Screwdriver with Flexible Shaft **NEW**

- Improves workability in cramped spaces! Stubby type that fits in your hand.
- Smoothly click feeling realized by rotating angle of 5° and 72 gears. High strength accomplished by 2 nails supporting the ratchet gear. It can be used for final tightening work.
- The handle is made out of oil-resistance cellulose acetate resin.
- Ball-lock bits can be replaced with one-touch.
- Bit insertion part ●6.35mm.



Set content			
Body	length 77mm	dia. 35mm	
Bits	⊕1, ⊕2, ⊖4, ⊖6 × 33mm		
Flexible Shaft (length 165mm)			
Package size (mm)	Inner Ctn.	Outer Ctn.	EDP No.
235×80×40	5	30	247027



**No. TD-81 Power Ratchet Screwdriver**

- Ratchet fine feed enables to fasten with a little wrist movement.
- Ideal ratchet mechanism for sufficient final tightening.
- 2 double-ended bits (different size combination) can be stored within the handle.
- Bit insertion part  $\phi$ 6.35mm



Model No.	Color	Bits	Package size (mm)	Inner Ctn.	EDP No.
TD-81R	Red	$\phi$ 1/ $\phi$ 4, $\phi$ 2/ $\phi$ 6 $\times$ 25.4	115 $\times$ 73 $\times$ 34	10	250081
TD-81G	Green	$\phi$ 1/ $\phi$ 4, $\phi$ 2/ $\phi$ 6 $\times$ 25.4	115 $\times$ 73 $\times$ 34	10	250082
TD-81B	Blue	$\phi$ 1/ $\phi$ 4, $\phi$ 2/ $\phi$ 6 $\times$ 25.4	115 $\times$ 73 $\times$ 34	10	250083

**No. TD-80 T-Bar Ratchet Screwdriver**

- Ratchet driving mechanism allows you to tighten a screw without adjusting your grip.
- Bit insertion part  $\phi$ 6.35mm



Set content

Body	T-bar ratchet screwdriver length 78mm dia. 73mm
Bits	$\phi$ 1, $\phi$ 2, $\phi$ 3, $\phi$ 4, $\phi$ 6 $\times$ 25.4mm
Accessory	Bit belt holder

Package size (mm)	Outer Ctn.	EDP No.
170 $\times$ 105 $\times$ 28	40	250080



**No. S-13 Handy Tool Set**

- Easy-to-use tool sets for fastening jobs around the house.
- Optimum for work at a corner or place with obstacles!
- Bit insertion part  $\phi$ 6.35mm



Set content

Body	T-bar ratchet screwdriver length 78mm dia. 73mm
Short Bits	$\phi$ 1, $\phi$ 2, $\phi$ 3, $\phi$ 4, $\phi$ 6, H2, H2.5, H3, H4, H5, H6 $\times$ 25.4mm
Accessory	Magnetic Bit holder (length 115mm) Flexible shank (length 145mm)

Package size (mm)	Outer Ctn.	EDP No.
240 $\times$ 143 $\times$ 45	10	250003



**No. 2200 Ball Ratchet Screwdriver NEW**

- With 36-teeth gear ratchet to realize comfortable operation with fine tuning.
- Shank cover prevents short circuits. Thin shank is convenient for operating on terminal blocks.



- Shank uses bit materials, fully hardened. Replacement shank is available as option.



**No.2200**

						Inner Ctn.	Outer Ctn.	EDP No.	
$\ominus$ 6 $\times$ 100	6.0	0.8	100	6.0	41	200	6	60	125395
$\ominus$ 6 $\times$ 150	6.0	0.8	150	6.0	41	250	6	60	125396
$\oplus$ 2 $\times$ 100	$\oplus$ No.2	100	6.0	41	200		6	60	125345
$\oplus$ 2 $\times$ 150	$\oplus$ No.2	150	6.0	41	250		6	60	125346
$\oplus$ 3 $\times$ 150	$\oplus$ No.3	150	6.0	41	250		6	60	125347

⚠ Electric insulation is not guaranteed. For safety purposes, shut off power before use.

**No. 2200B Ball Ratchet Screwdriver Reversible Blade NEW**

- Shank uses bit materials, fully hardened.
- Replacement blade; can be replaced by pulling out the ball-grip part of No.2200.



**No.2200B**

						Inner Ctn.	Outer Ctn.	EDP No.	
$\ominus$ 6 $\times$ 100	6.0	0.8	100	6.0	158		6	60	125397
$\ominus$ 6 $\times$ 150	6.0	0.8	150	6.0	208		6	60	125398
$\oplus$ 2 $\times$ 100	$\oplus$ No.2	100	6.0	158			6	60	125348
$\oplus$ 2 $\times$ 150	$\oplus$ No.2	150	6.0	208			6	60	125349
$\oplus$ 3 $\times$ 150	$\oplus$ No.3	150	6.0	208			6	60	125350

One point

Shanks are detachable from the ratchet part

Reversible blade can be replaced with one-touch.

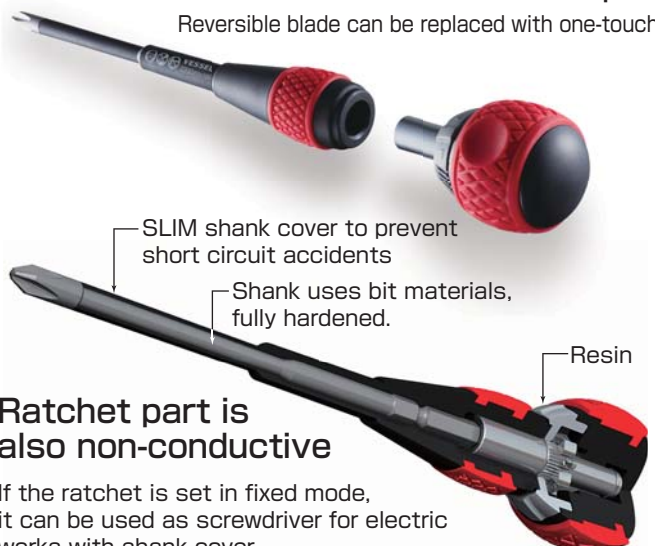

Ratchet part is also non-conductive

If the ratchet is set in fixed mode, it can be used as screwdriver for electric works with shank cover.

It is most suitable for working on distribution boards.

HAND TOOLS

BITS & SOCKETS

ELECTRIC TOOLS

AIR TOOLS

STATIC SOLUTIONS

GASOLINE ENGINE TOOLS

### No. TD-74 "PETA-RACHE" Flat-shaped Ratchet Screwdriver (straight type)

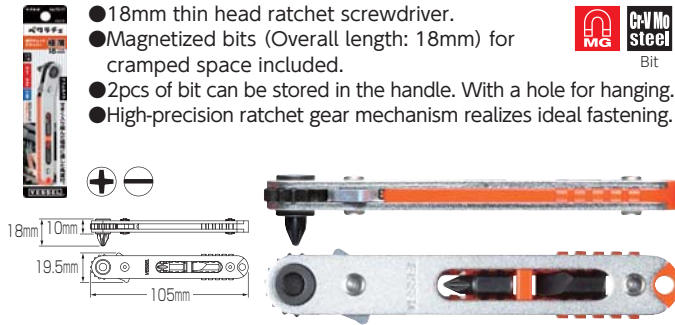

Model No.	Set content	Package size (mm)	Inner Ctn.	EDP No.
TD-74	Flat-shaped Ratchet Screwdriver (Straight type) Bits $\oplus 1, \oplus 2, \ominus 6 \times 18\text{mm}$	160x35x21	10	250074

### No. TD-77 "PETA-RACHE" Flat-shaped Ratchet Screwdriver (bent-up type)

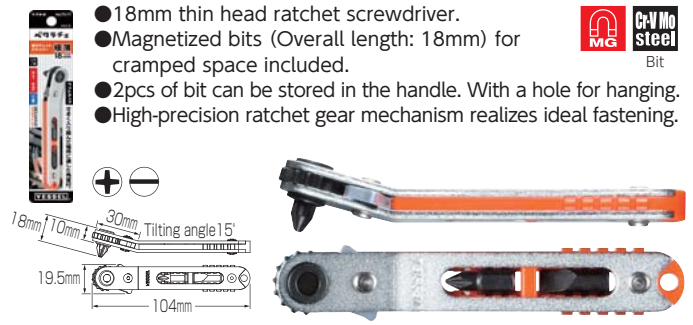

Model No.	Set content	Package size (mm)	Inner Ctn.	EDP No.
TD-77	Flat-shaped Ratchet Screwdriver (Angled type) Bits $\oplus 1, \oplus 2, \ominus 6 \times 18\text{mm}$	160x35x21	10	250077

### No. TD-75 "PETA-RACHE" Flat-shaped Ratchet Screwdriver (straight type)

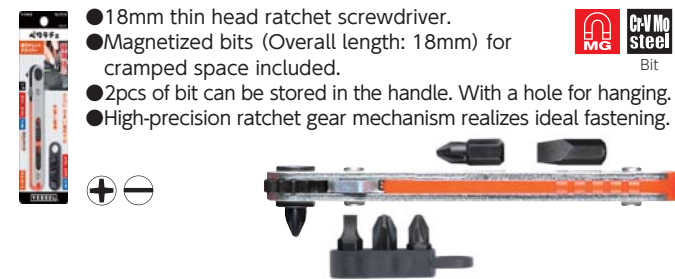

Model No.	Set content	Package size (mm)	Inner Ctn.	EDP No.
TD-75	Flat-shaped Ratchet Screwdriver (Straight type) Bits $\oplus 1, \oplus 2, \oplus 2, \oplus 3, \ominus 4, \ominus 6 \times 18\text{mm}$ Bit holder	160x50x21	10	250075

### No. TD-78 "PETA-RACHE" Flat-shaped Ratchet Screwdriver (bent-up type)



Model No.	Set content	Package size (mm)	Inner Ctn.	EDP No.
TD-78	Flat-shaped Ratchet Screwdriver (Angled type) Bits $\oplus 1, \oplus 2, \oplus 2, \oplus 3, \ominus 4, \ominus 6 \times 18\text{mm}$ Bit holder	160x50x21	10	250078

### No. TD-76 "PETA-RACHE" Flat-shaped Ratchet Screwdriver (straight type)



Model No.	Set content	Package size (mm)	Inner Ctn.	EDP No.
TD-76	Flat-shaped Ratchet Screwdriver (Straight type) Bits $\oplus 1, \oplus 2, \oplus 2, \oplus 3, \ominus 4, \ominus 6, \text{H}2.5, \text{H}3, \text{H}4, \text{H}5, \text{H}6 \times 18\text{mm}$ Bit holder	160x50x21	10	250076

### No. TD-79 "PETA-RACHE" Flat-shaped Ratchet Screwdriver (bent-up type)



Model No.	Set content	Package size (mm)	Inner Ctn.	EDP No.
TD-79	Flat-shaped Ratchet Screwdriver (Angled type) Bits $\oplus 1, \oplus 2, \oplus 2, \oplus 3, \ominus 4, \ominus 6, \text{H}2.5, \text{H}3, \text{H}4, \text{H}5, \text{H}6 \times 18\text{mm}$ Bit holder	160x50x21	10	250079

### No. TD-BS "PETA-RACHE" 18mm replacement bits

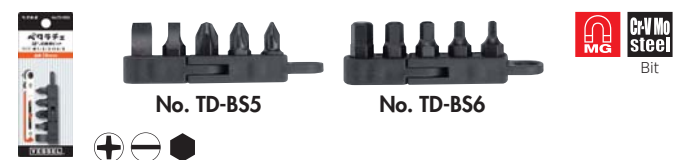

Model No.	Set content	Package size (mm)	Inner Ctn.	EDP No.
TD-BS5	Bits $\oplus 1, \oplus 2, \oplus 3, \ominus 4, \ominus 6 \times 18\text{mm}$ Bit holder	120x40x23	10	251304
TD-BS6	Bits H2.5, H3, H4, H5, H6x18mm Bit holder	120x40x23	10	251305



**No. TD-70 Flat Plate Ratchet Screwdriver Set**



Set content		Package size (mm)	Inner Ctn.	EDP No.
Body	Plate ratchet screwdriver			
Bits	Φ1, Φ2, Φ3, Φ4, Φ6, H2.5, H3, H4, H5, H6×25.4mm			
Accessory	Bit belt holder			

**No. TD-73MC Plate Ratchet Screw Catcher**



Set content		Package size (mm)	Inner Ctn.	EDP No.
Body	Plate ratchet screwdriver			
Bits	Φ1, Φ2, Φ3, Φ4, Φ6, H 2.5, 3, 4, 5, 6×25.4mm			
Accessory	Magnetic Screw Holder Bit belt holder			

**No. TD-71 Flat Plate Ratchet Screwdriver**

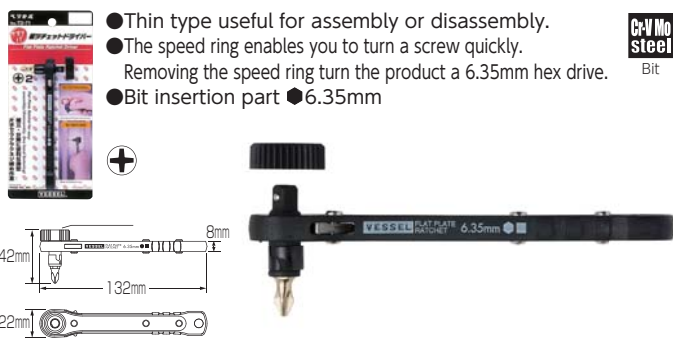

Set content		Package size (mm)	Inner Ctn.	EDP No.
Body	Plate ratchet screwdriver			
Bit	Φ2×25.4mm			

**No. TX-12MC Plate Ratchet/Magnetic Screw Catcher (TORX)**

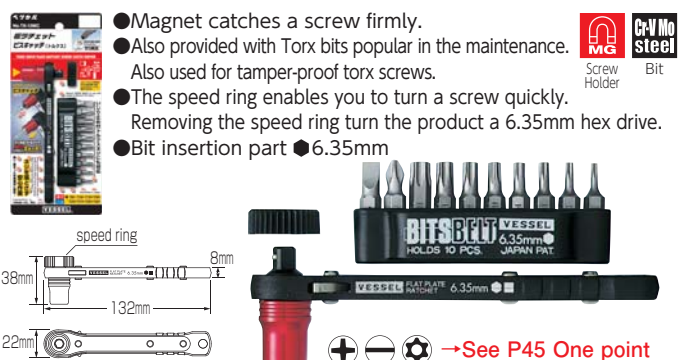

Set content		Package size (mm)	Inner Ctn.	EDP No.
Body	Plate ratchet screwdriver			
Bits	T8H, T10H, T15H, T20H, T25H, T27H, T30H, T40H, Φ2, Φ6×25.4mm			
Accessory	Magnetic Screw Holder Bit belt holder			

**No. TD-72 Flat Plate Ratchet Screwdriver Set**

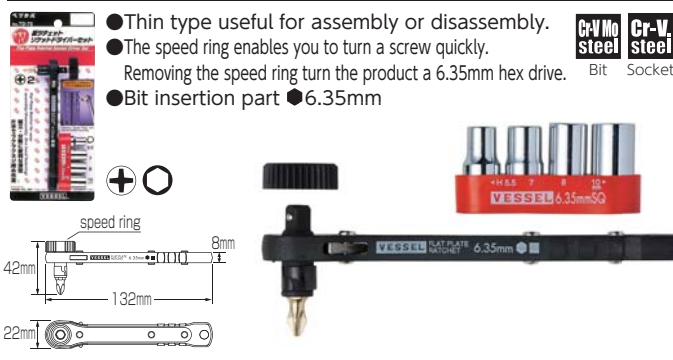

Set content		Package size (mm)	Inner Ctn.	EDP No.
Body	Plate ratchet screwdriver			
Bit	Φ2×25.4mm			
Socket	A/F 5.5, 7, 8, 10×26mm			
Accessory	Socket holder			

**No. TX-11 Plate Ratchet TORX Set**

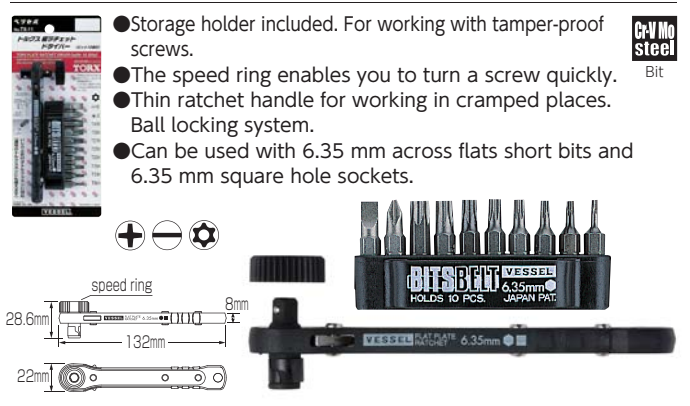

Set content		Package size (mm)	Inner Ctn.	EDP No.
Body	Plate ratchet screwdriver			
Bits	T8H, T10H, T15H, T20H, T25H, T27H, T30H, T40H, Φ2, Φ6×25.4mm			
Accessory	Magnetic Screw Holder Bit belt holder			

TORX® is a registered trademark of Acument TM Intellectual Properties, LLC (USA). VESSEL has a manufacturing license in Japan and selling same to the world.

HAND TOOLS  
 BITS & SOCKETS  
 ELECTRIC TOOLS  
 AIR TOOLS  
 STATIC SOLUTIONS  
 GASOLINE ENGINE TOOLS

### No. TD-BS Replacement Bit Set

**No. TD-BS1** **No. TD-BS2** **No. TD-BS3**

Applicable models  
TD-70/TD-71/TD-72/TD-73MC/TD-80/TD-150/TD-160/S-12/S-13  
TX-10/TX-11/TX-12MC/830MG-4/840/840L

Applicable models  
TD-70/TD-71/TD-72  
TD-170  
TX-11/TD-73MC  
TX-12MC

**No. TD-BS4**

Cr-V Mo steel Bit  
Cr-V steel Socket

Model No.	Set content	Package size (mm)	Inner Ctn.	EDP No.
TD-BS1	⊕1, ⊕2, ⊕3, ⊖4, ⊖6 ×25.4mm Bit belt holder	120×45×23	10	251300
TD-BS2	H 2.5, 3, 4, 5, 6 ×25.4mm Bit belt holder	120×45×23	10	251301
TD-BS3	T10H, T15H, T20H, T25H, T30H ×25.4mm Bit belt holder	120×45×23	10	251302
TD-BS4	A/F 5.5, 7, 8, 10 Socket holder	120×45×23	10	251303

TORX® is a registered trademark of Acument TM Intellectual Properties, LLC (USA). VESSEL has a manufacturing license in Japan and selling same to the world.

### No. TD-64 "PETADORA" Z-shaped Offset Screwdriver

- S-shaped type good for strong tightening in cramped spaces.
- Special plating to keep precision at the tip.

**No. TD-64**

	⊕2/⊖6	⊕1/⊕2
6	0.9 / ⊕No.2	18
6	1.29	6
10	100	126
100	100	100
EDP No.	250122	250121

Package size...160×35×12mm

### No. 25 Offset Screwdriver

- S-shaped type good for strong tightening in cramped spaces.
- Different size tips combined.
- Can be chosen according to applications.

**No. 25**

	⊕1/⊖5	⊕2/⊖6	⊕3/⊖8
25	5	125	12
26	6	125	12
33	8	150	12
EDP No.	143005	143006	143007

Package size...160×35×12mm

### No. 251526 2-Piece Offset Screwdriver Set

Model No.	Set content	Package size (mm)	Inner Ctn.	EDP No.
251526	No.25 ⊖6/⊕2, ⊖5/⊕1	210×70×10	20	243011

### No. TD-61 "PETADORA" L-shaped Offset Screwdriver

- Special plating to keep precision at the tip.
- L-shaped type good for working in cramped spaces.

**No. TD-61**

	⊖6	⊕1	⊕2
6	0.9	18	6
117	Blue	105	100
105	Green	100	100
117	Red	100	100
EDP No.	250105	250101	250102

Package size...160×35×14mm

### No. TD-63 "PETADORA" L-shaped Offset Screwdriver

- Special plating to keep precision at the tip.
- L-shaped type good for working in cramped spaces.

**No. TD-63**

	H 2.5	H 3	H 4	H 5
2.5	16.5	5	105	10
105	Orange	100	100	100
105	Purple	100	100	100
105	Black	100	100	100
117	Blue	100	100	100
EDP No.	250112	250113	250114	250115

Package size...160×35×14mm

## One point

Speedy fast-turning,  
firm tightening

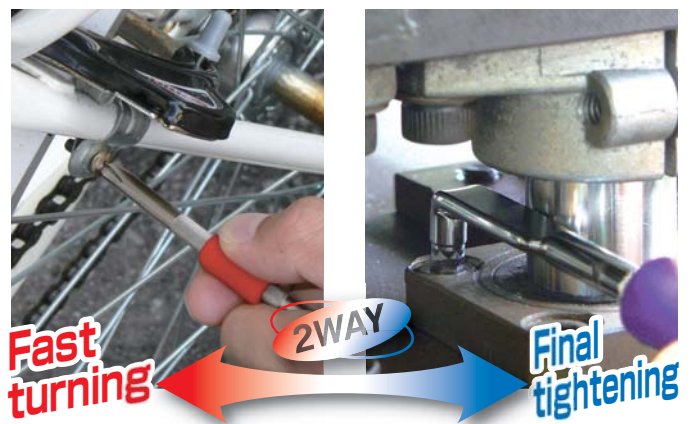

*This one product can be used from fast-turning to tightening!*

An evolution of offset screwdriver with all the required functions for tightening screws.



## No. 83L LED Voltage Detection Screwdriver

- For conduction/ continuity test in general household.
- Long-life LED lights brightly. Batteries can be replaced.
- Handy pencil-type screwdriver.



Voltage detection range	Reversible blade content (mm)					Package size (mm)	Inner Ctn.	EDP No.
	4.0	0.45	20	17.5	130			
100 to 250V AC						185×70×16	10	125106

## One point

### Conductivity check of electrical wiring tools

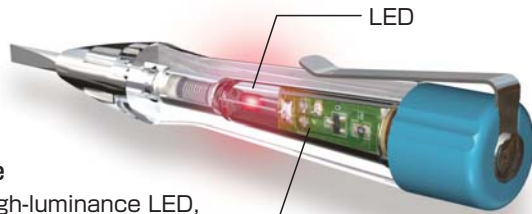

#### LED type

Uses a high-luminance LED, allowing you to check electrical conductivity easily even in a bright location. Batteries are consumables and need to be replaced.

### Conductivity check / polarity discrimination Continuity test

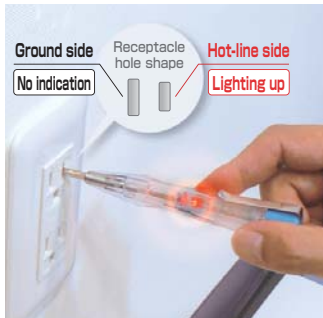

A conductivity check of electrical wiring or receptacle and polarity discrimination of AC hot-line and ground sides



Continuity check of a wiring circuit. Make sure that no power is applied to the circuit before checking continuity.

## No. TD-1300L

### 6-Piece Voltage Detection Screwdriver Set NEW

- Neon tube integrated into the grip end. When contacting the current-carrying point, the neon tube lights and continuity test can be conducted. **Cr-V. steel**
- Resin chuck enables to replace the blades. Lightweight resin grip, with a transparent end-cap at the grip edge.
- Frequently used 6 types of blade in a pack.
- Provided in a handy transparent vinyl carrying and storage pouch.
- Low voltage type (100 to 250V AC)



#### No. TD-1300L

Voltage detection range	Reversible blade content (mm)				Inner Ctn.	EDP No.
	⊖	⊕	Awl	Pin extractor		
100 to 250V AC	⊖4×125	⊕1×125	125	125	10	247021
	⊖6×125	⊕2×125	Handle length 126.4mm dia. 26.5mm			

※Package size...185×105×31mm

## No. TD-1300B

### 5-Piece Voltage Detection Screwdriver Set NEW

- Neon tube integrated into the grip end. When contacting the current-carrying point, the neon tube lights and continuity test can be conducted. **Cr-V. steel** Except Socket
- Resin chuck enables to replace the blades. Lightweight resin grip, with a transparent end-cap at the grip edge.
- A small diameter type socket suitable for small screws included in replacement blade set.
- Handy vinyl carrying and storage pouch
- Low voltage type (100 to 250V AC)



#### No. TD-1300B

Voltage detection range	Reversible blade content (mm)			Inner Ctn.	EDP No.
	⊖	⊕	Socket		
100 to 250V AC	⊖4×125	⊕1×125	A/F5 ×125	10	247031
		⊕2×125	A/F5.5×125		
Handle length 126.4mm dia. 26.5mm					

※Package size...185×105×31mm

HAND TOOLS

BITS & SOCKETS

ELECTRIC TOOLS

AIR TOOLS

STATIC SOLUTIONS

GASOLINE ENGINE TOOLS

## No. 240001 Impact Driver

- One-touch switching of the rotation direction.
- Soft non-slip resin handle, comfortable to grip. Designed for less shock on hands.
- For heavy-duty use.
- If the bit adapter is detached, a 12.7 mm socket can be attached.
- Bit insertion part ●8mm



Set content		Package size (mm)	Outer Ctn.	EDP No.
Bits	Φ2×36, Φ2×80, Φ3×36, Φ3×80, Φ4×36, ⊖10×36			
Body	length 176mm dia. 37.5mm	220×73×80	5	246051

## No. 250001 Impact Driver

- Effective for very tight fastening and loosening rusted screws.
- Suited for automobile maintenance, and assembly and disassembly of machinery and equipment.
- For heavy-duty use.
- If the bit adapter is detached, a 12.7 mm socket can be attached.
- Bit insertion part ●8mm



Set content		Package size (mm)	Outer Ctn.	EDP No.
Bits	⊖10, Φ2, Φ3, Φ4×36			
Body	length 166mm dia. 32mm	325×80×38	5	246001

## No. 260002 Impact Uni Driver

- Thin handle. Can be used as normal screwdriver.
- Long shank bit. Ideal for hard-to-reach cramped spaces.
- Bit insertion part ●6.35mm



Set content		Package size (mm)	Outer Ctn.	EDP No.
Bits	⊖5, ⊖6, ⊖7, Φ1, Φ2, Φ3×125			
Body	length 132.5mm dia. 26mm	225×110×33	5	246016

## No. C50/C51 Impact Driver Bit

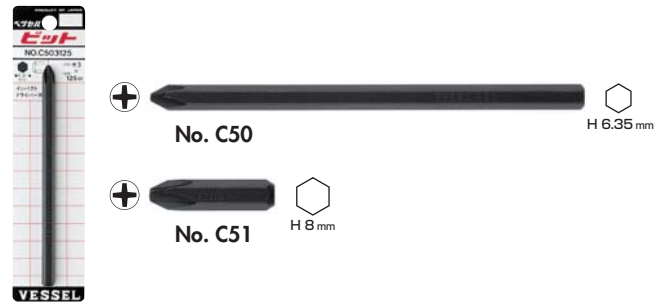

Model No.	Set content	Applicable models	Package size (mm)	Inner Ctn.	EDP No.
C502125	Φ2×125	260002	170×42	10	486212
C503125	Φ3×125	260002	170×42	10	486213
C506125	⊖6×125	260002	170×42	10	486216
C512036	Φ2×36	250001, 240001	170×42	10	486201
C513036	Φ3×36	250001, 240001	170×42	10	486202
C518036	⊖8×36	250001, 240001	170×42	10	486203

»For 10-Piece Set, please refer to page 83.

Mounting quantity: 1

## One point

### Removal of a rusted or stuck screw

Hitting the handle with a hammer causes the impact to be converted into rotational force.

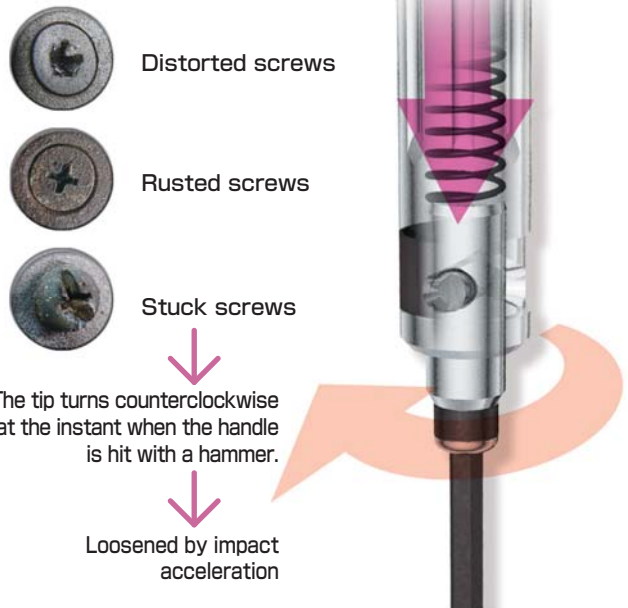



No. TRD-15

# Torque Screwdriver

HAND TOOLS

BITS & SOCKETS

ELECTRIC TOOLS

AIR TOOLS

STATIC SOLUTIONS

GASOLINE ENGINE TOOLS



High precision torque screwdrivers with a torque accuracy of  $\pm 10\%$  as specified by ISO 6789. Ergonomic & cushion grip friendly to your palm. The hand does not get tired even for long-hour work. For replacement of cemented carbide tips of various machining tools that have been going up in speed. For assembly torque management of precision machines. Also for appropriate tightening of terminal blocks, circuit breakers, or electro-magnetic switches.

Inserting the provided L-shape wrench into the rear of the handle and turning it allows torque setting to be easily accomplished.



## No. TRD-15 Torque Screwdriver

Made in Germany, these torque screwdrivers feature our patented double clutch mechanism for outstanding torque precision. High precision torque screwdrivers designed not merely for testing, but for serious, full-scale assembly operations.

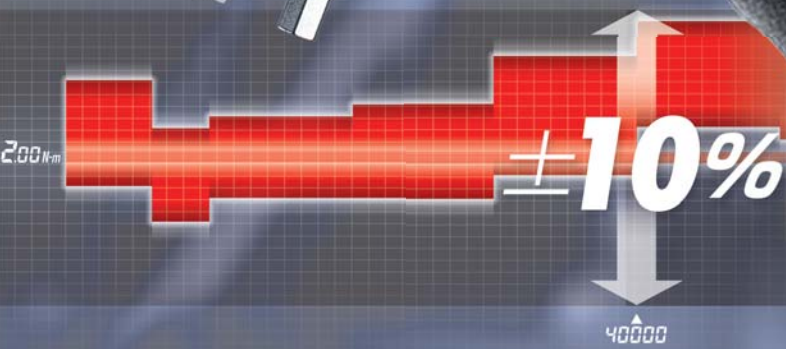

Long life by torque accuracy assurance of 40,000-time repetition

## No. TRD-15IP Torque Screwdriver Set

- For TORX PLUS clamp screws used for chip replacement.
- With popular TORX PLUS blades.



Set content	Torque range (N·m)	Package size (mm)	Outer Ctn.	EDP No.
TRD-15 Torque Screwdriver (Torque precision ±10%), 6IP, 7IP, 8IP, 9IP, L wrench (A/F 6mm)	0.6~1.5	215×40×40	10	173011

## No. TRD-15TX Torque Screwdriver Set

- For TORX clamp screws most often used for chip replacement.
- With popular TORX blades.
- Also suitable for tightening quality of hard disks.



Set content	Torque range (N·m)	Package size (mm)	Outer Ctn.	EDP No.
TRD-15 Torque Screwdriver (Torque precision ±10%), T6, T7, T8, L wrench (A/F 6mm)	0.6~1.5	215×40×40	10	173012

TORX® is a registered trademark of Acument TM Intellectual Properties, LLC (USA). VESSEL has a manufacturing license in Japan and selling same to the world.

## No. TRD-15 Torque Screwdriver Handle

- Can be used with the dedicated replaceable blades.
- HEX key wrench (A/F 6mm) is included.

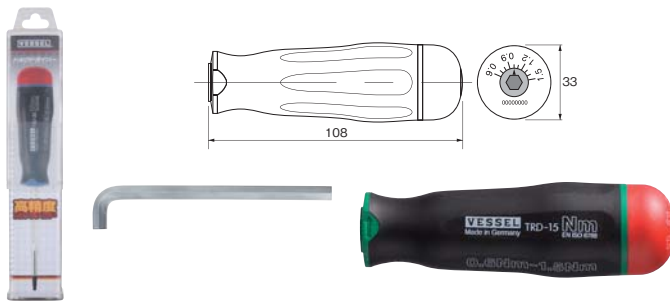

Model No.	Torque range (N·m)	1 scale (N·m)	Torque precision (%)	Package size (mm)	Outer Ctn.	EDP No.
TRD-15	0.6~1.5	0.1	±10	215×40×40	10	173001

## No. BTX Blades for Torque Screwdrivers

- Blades for TORX screws.
- Adopted for replacement of chips of machine tools that has been going up in speed.

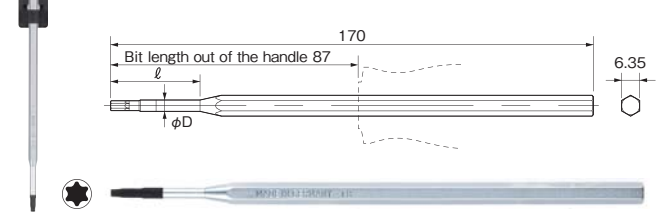

Model No.	Tip	l (mm)	φD (mm)	Outer Ctn.	EDP No.	
BTX06	T6	1.69	30	3.5	10	173206
BTX07	T7	1.97	30	3.5	10	173207
BTX08	T8	2.3	30	3.5	10	173208
BTX10	T10	2.72	30	3.5	10	173210
BTX15	T15	3.26	32	4.5	10	173215
BTX20	T20	3.84	34	5	10	173220

## No. B IP Blades for Torque Screwdrivers

- Blades for TORX PLUS screws.
- Adopted for replacement of chips of machine tools that has been going up in speed.



Model No.	Tip	l (mm)	φD (mm)	Outer Ctn.	EDP No.	
B06IP	6IP	1.69	30	3.5	10	173106
B07IP	7IP	1.97	30	3.5	10	173107
B08IP	8IP	2.29	30	3.5	10	173108
B09IP	9IP	2.48	30	3.5	10	173109
B10IP	10IP	2.72	30	3.5	10	173110
B15IP	15IP	3.25	30	4.5	10	173111

## No. BPH Blades for Torque Screwdrivers

- Blades for Phillips screws.
- Optimal for tightening control of various terminal blocks.



Model No.	Tip	l (mm)	φD (mm)	Outer Ctn.	EDP No.
BPH01	⊕1	35	5	10	173301
BPH02	⊕2	35	6	10	173302
BPH03	⊕3	—	—	10	173303

## No. BHX Blades for Torque Screwdrivers

- Blades for hexagonal socket head bolts and set screw.
- Optimum for assembly of machines or automatic equipment.



Model No.	Tip	l (mm)	φD (mm)	Outer Ctn.	EDP No.	
BHX15	H1.5	1.5	29.5	3	10	173321
BHX20	H2	2	29.5	3	10	173322
BHX25	H2.5	2.5	29.5	3	10	173323
BHX30	H3	3	32	4	10	173324
BHX40	H4	4	34	5	10	173325
BHX50	H5	5	36	6	10	173326



No. 8909BP

# "RAINBALL" L-wrenches



Easy to spot inside the toolbox. Color-coded by size. Provided with a portable holder to carry around easily. Can be used by fixing onto level metal parts of machine tools, automated machinery, surface plates, etc.



HAND TOOLS

BITS & SOCKETS

ELECTRIC TOOLS

AIR TOOLS

STATIC SOLUTIONS

GASOLINE ENGINE TOOLS



No. 8909BP

## "RAINBALL" L-wrenches 9PC SET

Inherits the large tilted angle, which is the greatest characteristic of the RAINBALL. Driving part is set so that it contacts near the entry point of hexagonal hole. Maximum tilted angle is approximately 38°. Moreover, it fits firmly to low head screws such as a button screw.

### Provided with a magnetizer

You can directly magnetize and demagnetize a wrench.

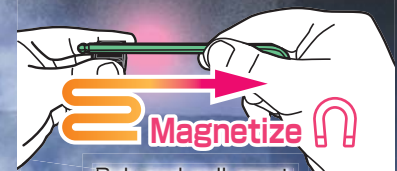

Rub and pull apart.



Even stronger when mounted on wrenches!

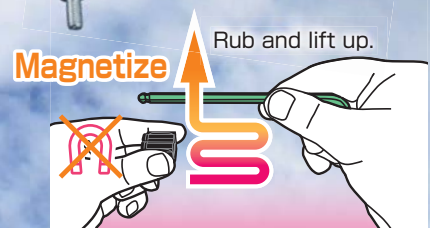

Rub and lift up.



### No. 8900BP "RAINBALL" L-wrenches NEW PAT.

- Easy to find in a toolbox. Color-coded by size. Coating is peel-proofed by manganese phosphate under coating.
- New ball shape. Set the driving part so that it contacts near the entry point of the hexagonal hole, with the maximum tilted angle of 38° (design value in our company). The cross-sectional area of the neck of the ball is enlarged to improve the strength.
- High precision black point tip, unaffected by metal plating.
- Cross-section is "Ultra-Hex", which has the 3-point and 3-surface contact geometry to reduce deforming of screw holes.



No.8900BP	Set content	Package size (mm)	Inner Ctn.	EDP No.
H 1.5	1.5 15 69	160×45×5	10	144341
H 2	2 17.5 74	160×45×5	10	144342
H 2.5	2.5 20 83.5	160×45×5	10	144343
H 3	3 22 93.5	160×45×5	10	144344
H 4	4 28 102.5	200×60×8	10	144345
H 5	5 32 123.5	200×60×8	10	144346
H 6	6 37 144	200×60×8	10	144347
H 8	8 43 166	235×75×14	5	144348
H 10	10 49 188.5	235×75×14	5	144349

※Colors inside the table cells indicate the body color.

### No. 8906BP "RAINBALL" L-wrenches 6PC Set NEW PAT.

- Easy to find in a toolbox. Color-coded by size.
- New ball shape with the maximum tilted angle of 38° (design value in our company). The cross-sectional area of the neck of the ball is enlarged to improve the strength.
- Provided with a convenient portable holder.



No.8906BP	Set content	Package size (mm)	Inner Ctn.	EDP No.
H 1.5, 2, 2.5, 3, 4, 5 mm		200×80×13	5	144352

### No. 8909BP "RAINBALL" L-wrenches 9PC Set NEW PAT.

- Provided with a holder that opens like a fan and utilized as a stand, together with a magnetizer.
- Can be fixed onto level metal parts of machine tools, automated machinery, surface plates, etc. by the magnetic force of the magnetizer mounted to the lower part of the holder.
- The magnetizer can be taken out from the holder and used to magnetize and demagnetize a wrench.

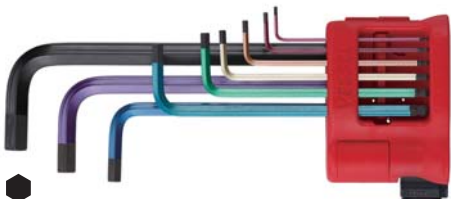

No.8909BP	Set content	Package size (mm)	Inner Ctn.	EDP No.
H 1.5, 2, 2.5, 3, 4, 5, 6, 8, 10 mm		245×110×35	5	144351

### No. 8409BP "ULTRABALL" L-wrenches 9PC Set NEW PAT.

- New ball shape with the maximum tilted angle of 38° (design value in our company). The cross-sectional area of the neck of the ball is enlarged to improve the strength.
- Cross-section is "Ultra-Hex", which has the 3-point and 3-surface contact geometry to reduce deforming of screw holes.
- Provided with a convenient portable holder. This is openable facilitating to pick a necessary size.



No.8409BP	Set content	Package size (mm)	Inner Ctn.	EDP No.
H 1.5, 2, 2.5, 3, 4, 5, 6, 8, 10 mm		245×105×27	5	144353

## One point

### No.8409BP Ultra Ball

Unique ball configuration allowing the tip to incline 38° maximum facilitates tightening or loosening of screws!

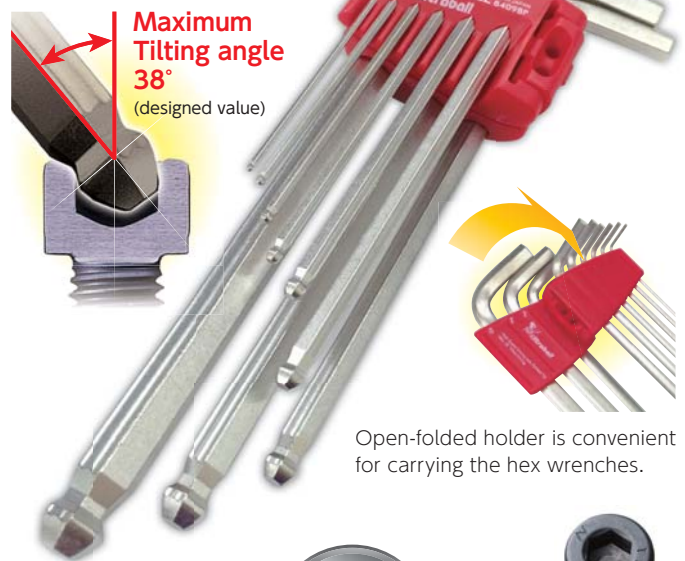

### Ultra Hex

Highly durable but no damage on screw surface! 3-point and 3-face contact hexagonal shape maximizes fastening effectiveness.



Surface Contact





**No. 8500TX TORX Key Wrench**

- Special plating to keep precision at the tip.
- Knurled shank for fast turning.
- Precision tips based on TORX spec.



No.8500TX	I				Package size (mm)	Inner Ctn.	EDP No.
T6	1.68	2.5	15	52	110×45×5	10	144301
T7	1.97	2.5	15	56	110×45×5	10	144302
T8	2.3	3	17	59	110×45×5	10	144303
T9	2.48	3	17	63	110×45×5	10	144304
T10	2.72	3	17	67	110×45×5	10	144305
T15	3.26	3.5	19	72	110×45×5	10	144306
T20	3.84	4	21	77	110×45×5	10	144307
T25	4.4	5	23	83	145×55×8	10	144308
T27	4.96	5	23	90	145×55×8	10	144309
T30	5.49	6	25	98	145×55×8	10	144310
T40	6.6	7	27	107	145×55×8	10	144311

**No. 8507TX TORX 7-Piece Key Set**

- Special plating to keep precision at the tip.
- Knurled shank for fast turning.
- Precision tips based on TORX spec.



Set content		Package size (mm)	Inner Ctn.	EDP No.
8500TX	T10, T15, T20, T25, T27, T30, T40	135×65×17	10	144315
Accessory	Vinyl package			

**No. TX-10 TORX Screwdriver Set**

- Provided with bits in a holder.
- Also good for tamper-proof screws.
- New type of bit holder that assuredly holds bits.
- Bit insertion part  $\phi$ 6.35mm
- Cellulose acetate resin grip. Ergonomic design.



Set content		Package size (mm)	Outer Ctn.	EDP No.
Body	length 204mm dia. 31.8mm	235×100×31	10	252020
Bits	T10H, T15H, T20H, T25H, T27H, T30H, T40H, $\oplus$ 2, $\oplus$ 3, $\ominus$ 6×25.4mm			
Accessories	Bit belt holder			

TORX® is a registered trademark of Acument TM Intellectual Properties, LLC (USA). VESSEL has a manufacturing license in Japan and selling same to the world.

**No. 5400TX Power Grip TORX Screwdriver**

- Champagne gold plating keeping the precise tip quality.
- Cellulose acetate resin grip. Ergonomic design.
- For working with tamper-proof screws (T5 and T6 excluded).



No.5400TX	I				Inner Ctn.	Outer Ctn.	EDP No.	
T 5 × 80	1.42	80	2.5	17.0	155	12	60	122854
T 6 × 80	1.69	80	2.5	17.0	155	12	60	122855
T 7H× 80	1.97	80	2.5	17.0	155	12	60	122856
T 8H× 80	2.3	80	3.0	17.0	155	12	60	122857
T 9H× 80	2.48	80	3.0	17.0	155	12	60	122858
T10H× 80	2.72	80	3.0	17.0	155	12	60	122859
T15H× 80	3.26	80	3.5	28.0	177	6	60	122860
T20H× 120	3.84	120	4.0	28.0	217	6	60	122861
T25H× 120	4.4	120	5.0	31.8	224	6	60	122862
T27H× 120	4.96	120	5.0	31.8	224	6	60	122863
T30H× 120	5.49	120	6.0	35.6	235	6	60	122864
T40H× 120	6.6	120	7.0	35.6	235	6	60	122865

TORX® is a registered trademark of Acument TM Intellectual Properties, LLC (USA). VESSEL has a manufacturing license in Japan and selling same to the world.

HAND TOOLS  
BITS & SOCKETS  
ELECTRIC TOOLS  
AIR TOOLS  
STATIC SOLUTIONS  
GASOLINE ENGINE TOOLS

## No. Q6E TORX "E" Socket (SQ9.5mm)

- Work socket (Cannot be used with power tools.)
- Has the 9.5 mm square hole, optimal for automobile maintenance and repair.

**Cr-V Mo Steel**  
Shank only

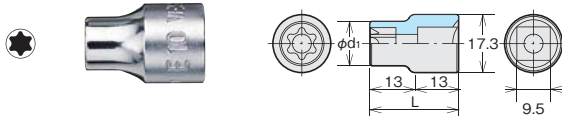

Model No.	TORX No.		$\phi d1$	L (mm)	Inner Ctn.	EDP No.
Q6E8	E8	7.47	9.9	26	10	621151
Q6E10	E10	9.37	12.0	26	10	621152
Q6E12	E12	11.12	14.5	26	10	621153

## No. Q4T TORX T-type Socket (SQ 6.35mm)

- Work socket (Cannot be used with power tools.) Tamper proof torx.
- Has the 6.35 mm square hole, optimal for automobile maintenance and repair.

**Cr-V Mo Steel**  
Shank only

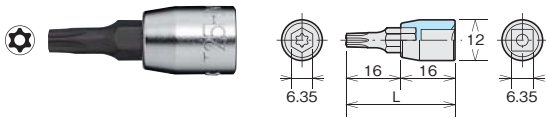

Model No.	TORX No.		L (mm)	Inner Ctn.	EDP No.
Q4T10H	T10H	2.72	32	10	621131
Q4T15H	T15H	3.26	32	10	621132
Q4T27H	T27H	4.96	32	10	621135

## No. Q6T TORX T-type Socket (SQ 9.5mm)

- Work socket (Cannot be used with power tools.)
- Has the 9.5 mm square hole, optimal for automobile maintenance and repair.

**Cr-V Mo Steel**  
Shank only

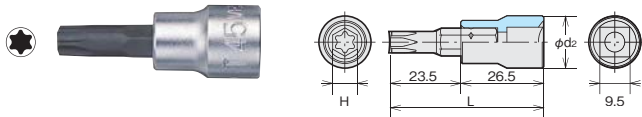

Model No.	TORX No.		$\phi d2$	H	L (mm)	Inner Ctn.	EDP No.
Q6T30	T30	5.49	18	6.35	50	10	621136
Q6T45	T45	7.77	18	8	50	10	621138
Q6T50	T50	8.79	20	10	50	10	621139

## No. 944TX 4-Piece MEGADORA FOD TORX Screwdriver Set

**PAT.**

- Used for work in automobile maintenance field
- Provided with a two-layer structured tray that prevents a screwdriver from being left.

**eco Cr-V Steel**



Set content		Tray size (mm)	Inner Ctn.	Outer Ctn.	EDP No.
No.940TX	T20HX120,T25HX120 T30HX120,T40HX120	280x135x35	1	20	125804

TORX® is a registered trademark of Acument™ Intellectual Properties, LLC (USA). VESSEL has a manufacturing license in Japan and selling same to the world.

## One point

### Features of TORX tool



Basic TORX consists of 6 ear-lobular shaped curves. Compared to hexagonal shape driver, TORX has higher drive effectiveness and transfers torque smoothly and accurately while eliminating "CAM-OUT".

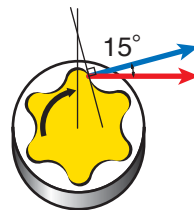

**TORX**  
TORX transfers max torque due to small driving angle.

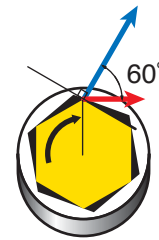

**Hex**  
Meanwhile, Hex square drive need max upload torque to transfer for large diving angle to other directions.

## TAMPER-PROOF TORX SYSTEM



Added function of "Never Touch Screw" a post in the middle of the recess for maximum security eliminates regular TORX drive or any other flat screwdrivers for safety. Tamper proof screws are mostly used at communication equipment and computers so as not to abuse the screwing/unscrewing due to its design and control of function Keep off unscrewing unless otherwise maintenance serving practiced.

TORX® is a registered trademark of Acument™ Intellectual Properties, LLC (USA). VESSEL has a manufacturing license in Japan and selling same to the world.



**No. TX-12MC Plate Ratchet/Magnetic Screw Catcher (TORX)**

- Magnet catches a screw firmly.
- Also provided with Torx bits popular in the maintenance. Also used for tamper-proof torx screws.
- The speed ring enables you to turn a screw quickly. Removing the speed ring turn the product a 6.35mm hex drive.
- Bit insertion part ● 6.35mm



Set content		Package size (mm)	Inner Ctn.	EDP No.
Body	Plate ratchet screwdriver	190×85×27	10	252022
Bits	T8H, T10H, T15H, T20H, T25H, T27H, T30H, T40H, $\Phi 2$ , $\Phi 6 \times 25.4$ mm			
Accessory	Magnetic Screw Holder Bit belt holder			

**No. TX-11 TORX Plate Ratchet and Bit Set**

- Storage holder included. For working with tamper-proof screws.
- The speed ring enables you to turn a screw quickly.
- Thin ratchet handle for working in cramped places. Ball locking system.
- Can be used with 6.35 mm across flats short bits and 6.35 mm square hole sockets.



Set content		Package size (mm)	Inner Ctn.	EDP No.
Body	Plate ratchet screwdriver	190×85×27	10	252021
Bits	T8H, T10H, T15H, T20H, T25H, T27H, T30H, T40H, $\Phi 2$ , $\Phi 6 \times 25.4$ mm			
Accessory	Magnetic Screw Holder Bit belt holder			

**No. B-340TX Wood-Compo TORX Screwdriver NEW**

- Extraordinary non-slip grip; Secures working efficiency even with oily hands.
- Wood-composite resin, reproducing the natural material texture.
- Non-electrolytic plating, keeping the precise tip quality.
- Also good for tamper-proof TORX screws.

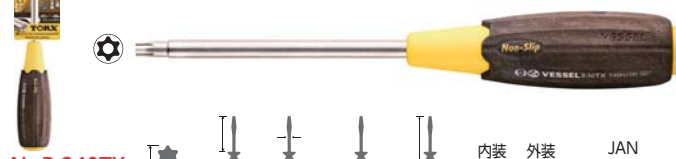

No.	T	H	Length (mm)	Inner Ctn.	Outer Ctn.	JAN (4907587)
T10H	2.72	80	5.5	30	188	6 120 120081
T15H	3.26	80	5.5	30	188	6 120 120082
T20H	3.84	120	5.5	30	228	6 120 120083
T25H	4.40	120	6.4	32	236	6 60 120084
T27H	4.96	120	6.4	32	236	6 60 120085
T30H	5.49	120	8.0	35	246	6 60 120086
T40H	6.60	120	8.0	35	246	6 60 120087

**No. B-640TX Cushion Grip TORX Screwdriver NEW**

- Optimal for fastening screws in precision fields.
- Non-electrolytic plating, keeping the precise tip quality.
- Cushion grip fitting comfortably in a hand.
- Also good for tamper-proof TORX screws (except T5 and T6).



No.	T	H	Length (mm)	Inner Ctn.	Outer Ctn.	EDP No.
T5	1.42	40	4.0	20.5	126	6 60 123561
T6	1.69	40	4.0	20.5	126	6 60 123562
T7H	1.97	40	4.0	20.5	126	6 60 123563
T8H	2.30	40	4.0	20.5	126	6 60 123564
T9H	2.48	40	4.0	20.5	126	6 60 123565

**No. TD-6310TX TORX Screwdriver Set NEW**

- Bit insertion part ● 6.35mm. Magnetized.
- Holds securely short bits. Reliable fastening as the bit does not drop easily.
- Grip made of environmental-friendly plant material.
- Provided with a bit belt for storage.



Set content		Package size (mm)	Outer Ctn.	EDP No.
Body	length 213mm dia. 28.5mm	235×100×29	10	247028
Bits	$\Phi 6$ , $\Phi 2$ , T8H, T10H, T15H, T20H, T25H, T27H, T30H, T40H ×25.4mm			
Accessories	Bit belt holder			

TORX® is a registered trademark of Acument TM Intellectual Properties, LLC (USA). VESSEL has a manufacturing license in Japan and selling same to the world.

HAND TOOLS

BITS & SOCKETS



ELECTRIC TOOLS

AIR TOOLS

STATIC SOLUTIONS







GASOLINE ENGINE TOOLS

**No. 990TX G-grip TORX Screwdriver PAT.**



- The weight of the steel ball keeps the end cap in an optimum position for a grip.   
- A special precision spring is welded to the tip by laser, enabling the screwdriver to catch a TORX screw firmly by spring action.



**No.990TX**

	Inner (mm)	Outer (mm)	Inner Ctn.	Outer Ctn.	EDP No.			
<b>T3 × 40</b>	1.13	40	2.5	16	21 138	12	240	125921
<b>T5 × 40</b>	1.42	40	2.5	16	21 138	12	240	125923
 <b>T6 × 40</b>	1.69	40	2.5	16	21 138	12	240	125924
 <b>T8 × 40</b>	2.3	40	2.5	16	21 138	12	240	125926
 <b>T9 × 40</b>	2.48	40	4.0	16	21 138	12	240	125927
 <b>T10×80</b>	2.72	80	4.0	30	38 195	6	60	125928
 <b>T15×80</b>	3.26	80	5.5	30	38 195	6	60	125929
 <b>T20×80</b>	3.84	80	5.5	30	38 195	6	60	125930

**No. TD-6816MG Ratchet Screwdriver (16-pc bit set) NEW**



- Smoothly click feeling realized by rotating angle of 5° and 72 gears. High strength accomplished by 2 nails supporting the ratchet gear. It can be used for final tightening work.   
- The handle is made out of oil-resistance cellulose acetate resin.
- Easy to carry around with cassette type bit storage inside the handle.
- 16 types of bits to adapt to various types of work. Magnetic bits can be replaced with one-touch.
- Bit insertion part ●6.35mm.



Set content			
Body	length 177mm dia. 28.5mm		
Bits	⊕1, ⊕2, ⊕3, ⊖6, H2, H2.5, H3, H4, H5, T10H, T15H, T20H, T25H, T27H, T30H, T40H ×25.4mm		

Package size (mm)	Inner Ctn.	Outer Ctn.	EDP No.
235×90×29	5	30	247025

**No. TD-6808TX Ratchet Screwdriver TORX (8-pc bit set) NEW**

- Smoothly click feeling realized by rotating angle of 5° and 72 gears. High strength accomplished by 2 nails supporting the ratchet gear. It can be used for final tightening work.   
- The handle is made out of oil-resistance cellulose acetate resin.
- Easy to carry around with cassette type bit storage inside the handle.
- Stores 8 types of bits including TORX bit. Magnetic bits can be replaced with one-touch.
- Bit insertion part ●6.35mm.



Set content			
Body	length 177mm dia. 28.5mm		
Bits	⊕2, ⊕3, T10H, T15H, T20H, T25H, T30H, T40H ×25.4mm		

Package size (mm)	Inner Ctn.	Outer Ctn.	EDP No.
235×80×29	5	30	247024

**No. TD-BS3 Replacement Bit Set**





Model No.	Set content	Package size (mm)	Inner Ctn.	EDP No.
<b>TD-BS3</b>	T10H, T15H, T20H, T25H, T30H ×25.4mm Bit belt holder	120×45×23	10	251302







TORX® is a registered trademark of Acument TM Intellectual Properties, LLC (USA). VESSEL has a manufacturing license in Japan and selling same to the world.

TORX is also available for bits.





**Industrial Bits Type A**

- No.V TORX Bit ..... P62
- No.V TORX Bit (Tamper-Proof) ..... P63
-   No.V5 TORX Bit ..... P64
-  No.V5 TORX Bit (Tamper-Proof) ..... P64

**Industrial Bits Type B**

- No.N TORX Bit ..... P67, P78
- No.N TORX Bit (Tamper-Proof) ..... P67, P78
-   No.J TORX Bit ..... P70
-   No.J TORX Bit (Tamper-Proof) ..... P70
-  No.A5 TORX Bit ..... P71
-  No.A5 TORX Bit (Tamper-Proof) ..... P71

**Precision Bits**

- No.DS73 Shockless Bit ..... P75
-  No.D71 TORX Bit ..... P76
-  No.D73 TORX Bit ..... P76
-  No.D76 TORX Bit ..... P77
-  No.D76 TORX Bit (Tamper-Proof) ..... P77

**Short Bits**

- No.A4 TORX Bit ..... P82
-  No.A4 TORX Bit (Tamper-Proof) ..... P82

**Construction Bits**

- No.SMVT TORX Bit (Tamper-Proof) ..... P95
-  No.SMVT TORX Bit (Tamper-Proof) ..... P95

**"PROKON" series**

- No.SS16T Recessed "SAKISUBO" TORX Bit ..... P111
-  No.SS16T Recessed "SAKISUBO" TORX Bit ..... P111

TORX® is a registered trademark of Acument TM Intellectual Properties, LLC (USA). VESSEL has a manufacturing license in Japan and selling same to the world.

HAND TOOLS  
BITS & SOCKETS  
ELECTRIC TOOLS  
AIR TOOLS  
STATIC SOLUTIONS  
GASOLINE ENGINE TOOLS



No. 3200VA-1

## VA cable stripper



The 3200VA-1 is a solution for stripping strenuous cables such as VA cables which becomes soft and elongates during the summer or as eco-friendly PE cables, which hardness during winter months.



**No. 3200VA-1**

### VA cable stripper

The depth of cut by blades can be adjusted by 5 levels to support the different hardness of coating for different wire manufacturers. Designed to hold the wire coating so that the core line is always at the center, to prevent jamming.

HAND TOOLS

BITS & SOCKETS

ELECTRIC TOOLS

AIR TOOLS

STATIC SOLUTIONS

GASOLINE ENGINE TOOLS

## No. 3200VA-1 VA cable stripper

PAT.

- Even for eco-friendly PE cables, clear stripping can be perfectly achieved with light force. 
- Corresponds to various sheath hardness according to cable manufacturers. Can adjust cutting depth in 5 steps.
- Precision blades by the metal injection offer excellent cutting quality.
- Designed to hold wire sheath so that the core conductor is always located at the center, preventing the blades from cutting into the conductor.



← See P48



Model No.	Overall length (mm)	Weight (g)	Wire size	Outer Ctn.	EDP No.
3200VA-1	180	370	PVC cables (VVf/ VA cables) PE cables (EM-EEF/ Eco cables) φ1.6mm duplex/φ2.0mm duplex φ1.6mm triplex/φ2.0mm triplex	5	141016

Package size...250×115×63mm



## No. WB-013 For 3200VA-1 Replacement Blade

Model No.	Applicable wire stripper	Package size (mm)	Inner Ctn.	EDP No.
WB-013	3200VA-1	120×45×3	10	141084

## No. 3500E-1/-2 Wire Stripper



- Lightweight (100g), compact handy type. 
- Diamond finely polished blade for precision stripping.
- AWG-mm-mil conversion table on the grip.



Model No.	Overall length (mm)	Weight (g)	Color	Inner Ctn.	Outer Ctn.	EDP No.
3500E-1	155	100	Red	5	30	141036
3500E-2	155	100	Yellow	5	30	141037

Package size...220×75×13mm

3500E-1	AWG	12	14	16	18	20	22	24
	Solid wire (mm)	2.0	1.6	1.3	1.0	0.8	0.65	0.5
Standard wire (mm)	3.3	2.0	1.3	0.8	0.5	0.3	0.2	
3500E-2	AWG	18	20	22	24	26	28	30
	Solid wire (mm)	1.0	0.8	0.65	0.5	0.4	0.3	0.25
Standard wire (mm)	0.8	0.5	0.3	0.2	0.13	0.08	0.05	

## No. 3000 Wire Stripper

- Nimble and cleanly strips off sheathing in a single operation. 
- Can be used with wiring for TV, radio, home appliances, electrical work, automotive circuits, telephones, etc.
- With a strip gauge.



Model No.	Overall length (mm)	Weight (g)	Wire diameter and nominal sectional area	Handle color	Outer Ctn.	EDP No.
3000A	170	350	For solid wire 0.5/1.2/1.6/2.0mm	Green	20	141001
3000B	170	350	For solid wire 1.0/1.6/2.0/2.6/3.2mm	Red	20	141002
3000C	170	350	For stand wire 0.9/1.25/2.0/3.5/5.5mm	Black	20	141000

Package size...220×75×13mm

## Wire Stripper Cardbord product

Model No.	Wire diameter and nominal sectional area	Package size (mm)	Outer Ctn.	EDP No.
300001	For solid wire 0.5/1.2/1.6/2.0mm	250×110×38	5	241001
300002	For solid wire 1.0/1.6/2.0/2.6/3.2mm	250×110×38	5	241002
300005	For stand wire 0.9/1.25/2.0/3.5/5.5mm	250×110×38	5	241005

## Wire Stripper Blade

Model No.	Applicable wire stripper	Wire diameter and nominal sectional area	Package size (mm)	Inner Ctn.	EDP No.
WB-001	3000 A, 300001	For solid wire	95×30×15	5	141071
WB-002	3000 B, 300002	For solid wire	95×30×15	5	141072
WB-003	3000 C, 300005	For stand wire	95×30×15	5	141073

# One point

## Features of wire strippers

### 3200VA-1



Wire strippers dedicated for VA cables and eco-friendly PE cables (VVf/EM-EEF)

For solid wire 1.6mm×2/3duplex/triplex

For solid wire 2.0mm×2/3duplex/triplex

### 3500E-1/3500E-2



For cutting and stripping of various electronic wires represented by KV

For solid wire 0.25mm~2.0mm

For stand wire 0.05mm~3.3mm

### 3000



For stripping of various wires and cords including IV and VSF

Solid wires: 0.5mm to 3.2mm

Stranded cables: 0.9mm to 5.5mm



**No. DB-200 Bucket for Electricians NEW**

- Convenient for collecting wire scraps and carrying tools and instruments.
- Belt length can be adjusted.
- Elliptical shape to fit comfortably.



Size with header (mm)	Outer Ctn.	EDP No.
H280 x W200 x D125	1	141034

**No. 76-10 Gel Grip Hammer (Plastic Head) NEW**

- Gel resin grip drastically absorbs the shocks by hammer blows to your palm. Alleviates the strain on your wrist.
- Slip resistance grip design of elastomer resin.
- Excellent balance between both heads, ensuring firm feeling of hammering.
- Hammer heads are screwed on and replaced easily. Replacement head is available as option.



Model No.	Size	Length	Head Diameter	Head Length (mm)	Weight (g)	Inner Ctn.	Outer Ctn.	EDP No.
<b>76-10</b>	1	315	32	120	430	6	60	142082

**Replacement Head for No.76 (Plastic Head)**

Model No.	Set content	Package size (mm)	Inner Ctn.	Outer Ctn.	EDP No.
<b>076110</b> Card Product	1Lb×2pcs	170×60×35	-	5	242024
<b>76-10H</b> Boxed	1Lb	130×155×35	20	400	142131

※Apply hammer Gel Grip Hammer No.76-10 No.77-10  
Plastic Head Hammer No.70-1



**No. 70 Plastic Head Hammer**

- Soft durable plastic head. Does not damage workpieces.
- Replacement head is available as option in a box.
- Replacement head of 1/2, 1 and 1 1/2 sizes is also available in 2-pc pre-carded package.



To replace the hammer head

Size	Length	Head		Inner Ctn.	Outer Ctn.	EDP No.
		Diameter	Length (mm)			
<b>1/4</b>	280	19.5	66.5	6	60	142001
<b>1/2</b>	280	25	82	6	60	142002
<b>1</b>	295	31.3	108	6	60	142003
<b>1 1/2</b>	325	37.6	125.5	6	36	142004
<b>2</b>	350	45.4	139	6	24	142005

Handles are not separately sold.

**Replacement head for No.70**

Model No.	Set content	Package size (mm)	Inner Ctn.	Outer Ctn.	EDP No.
<b>Head 70×1/4</b>	1/4	85×102×20	20	-	142011
<b>Head 70×1/2</b>	1/2	110×132×27	20	400	142012
<b>Head 70×1</b>	1	130×155×35	20	400	142013
<b>Head 70×1 1/2</b>	1 1/2	80×185×42	10	400	142014
<b>Head 70×2</b>	2	100×225×48	10	400	142015

**Replacement head for No.70 Cardbord Products**

Model No.	Set content	Package size (mm)	Outer Ctn.	EDP No.
<b>070105</b>	1/2×2pcs	170×60×26	5	242012
<b>070110</b>	1×2pcs	170×60×35	5	242013
<b>070115</b>	1 1/2×2pcst	210×75×41	5	242014



⚠ WARNING concerning Hammers

- Strike target directly. Do not hit at an angle, etc.
- Do not strike anywhere but the target area.

**No. 77-10 Gel Grip Hammer (Rubber/Plastic Head)**

- Gel resin grip drastically absorbs the shocks by hammer blows to your palm. Alleviates the strain on your wrist.
- Slip resistance grip design of elastomer resin.
- Excellent balance between both heads, ensuring firm feeling of hammering.
- Hammer heads are screwed on and replaced easily. Replacement head is available as option.
- The hammer heads are screwed on and replaced easily. Rubber head is available as option. Rubber head is of light gray color, which does not cause color staining to the object.



Model No.	Size	Length	Head Diameter	Head Length (mm)	Weight (g)	Inner Ctn.	Outer Ctn.	EDP No.
<b>77-10</b>	1	315	32	120	430	6	60	142091

**Replacement Head for No.77 (Rubber Head)**

Model No.	Set content	Package size (mm)	Inner Ctn.	Outer Ctn.	EDP No.
<b>077110</b> Card Product	1Lb×2pcs	170×60×35	-	5	242021
<b>77-10H</b> Boxed	1Lb	130×155×35	20	400	142121

※Apply hammer Gel Grip Hammer No.77-10  
Cannot be used for plastic hammer No.70-1.



One point

GEL resin grip



**Built-in gel cushions the shock to the palm**

Cushions the shock to the palm of hammering blows. Alleviates the strain on your wrist.

**Slip-resistant grip design**

By gel, the contact surface with the palm increases. Non-slip grip with projected parts.



HAND TOOLS

BITS & SOCKETS

ELECTRIC TOOLS

AIR TOOLS

STATIC SOLUTIONS

GASOLINE ENGINE TOOLS

## No. RG-95 Ratchet Rivet Gun



- Can calk blind rivets easily with one hand.
- Easily calks 4.8 mm steel rivets that were difficult to use with existing manual riveters.



Set content		Package size (mm)	Outer Ctn.	EDP No.
Body	overall length 230mm weight 570g	350×140×30	5	621310
Accessories	Nose piece 2.4, 3.2, 4.0, 4.8mm Nose piece wrench A/F 10mm			

## No. 8 Thread File

- Quickly restores threads of tooling machines, automobiles, etc.
- 1 tool can be used with 8 different thread pitches.

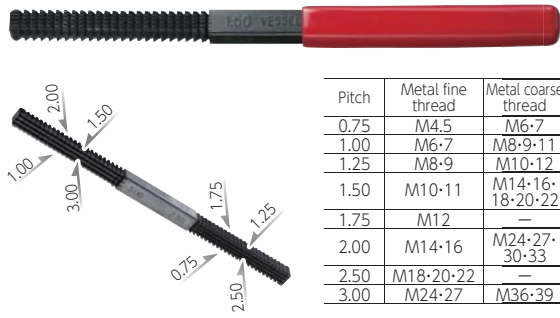

Pitch	Metal fine thread	Metal coarse thread
0.75	M4.5	M6-7
1.00	M6-7	M8-9-11
1.25	M8-9	M10-12
1.50	M10-11	M14-16-18-20-22
1.75	M12	—
2.00	M14-16	M24-27-30-33
2.50	M18-20-22	—
3.00	M24-27	M36-39

Set content		Package size (mm)	Outer Ctn.	EDP No.
Pitch (mm)	0.75 / 1.00 / 1.25 / 1.50 1.75 / 2.00 / 2.50 / 3.00	270×75×12	10	621111

## No. 5700WP Water Faucet Screwdriver

- Large sized tip enables stable fastening work as it fits well.



Package size (mm)		Inner Ctn.	EDP No.					
18	1.6	85	8	30	134.5	182×40×30	6	121572

## No. 5700BD Car Battery Screwdriver

- Special coin-shaped drive tip with A/F 10mm hexagonal opening.
- Handle color changes depending on viewing angle.

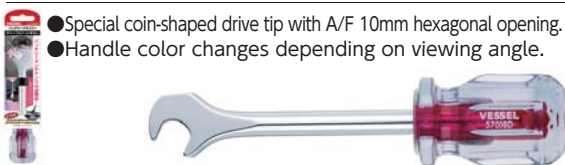

Package size (mm)		Inner Ctn.	EDP No.						
18	10	1.6	85	8	28.5	133	182×40×30	6	121571

## No. ZW-3/ZW-4 Thread Thru Stud Wrench

- Works with continuous thread studs, cut bolts and hanger bolts.
- Can be used 2 ways: Straight for tightening, or bent for fast turning.
- Can be used from halfway point with long hanger bolts.
- Lightweight, compact and easy to carry.

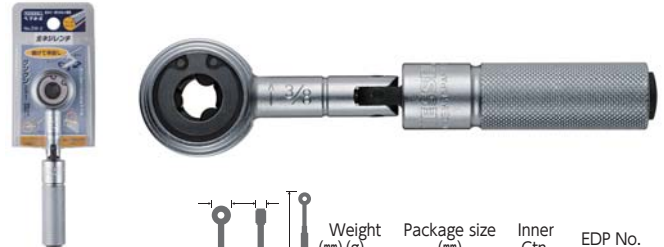

	Thread part	32	20	140	Weight (mm) (g)	Package size (mm)	Inner Ctn.	EDP No.
ZW-3	3/8	32	20	140	224	195×64×27	10	621320
ZW-4	1/2	32	20	140	222	195×64×27	10	621321

## One point

### Features of special tools



**Ratchet Rivet Gun**  
Allows you to caulk blind rivets easily with one hand



**Thread File**  
For restoring of screw threads  
One file can be used for eight different thread pitches.



**Thread Thru Stud Wrench**  
Dedicated for installing a full-thread bolt  
It can be bent to turn a bolt quickly.



**Tap Screwdriver**  
Used for tightening and loosening of a water shut-off valve, flow-regulating valve, or check valve



**Car Battery Screwdriver**  
It is a combination of a spanner with width across flats of 10mm for car battery removal and a coin-shaped drive tip.