



Datasheet

RS PRO Stainless steel toggle latch with hole for lock, 75mm length

Stock number: 1929631

EN



- Stainless steel (304) sprung toggle latch
- With hole for padlock
- Complete with catchplate

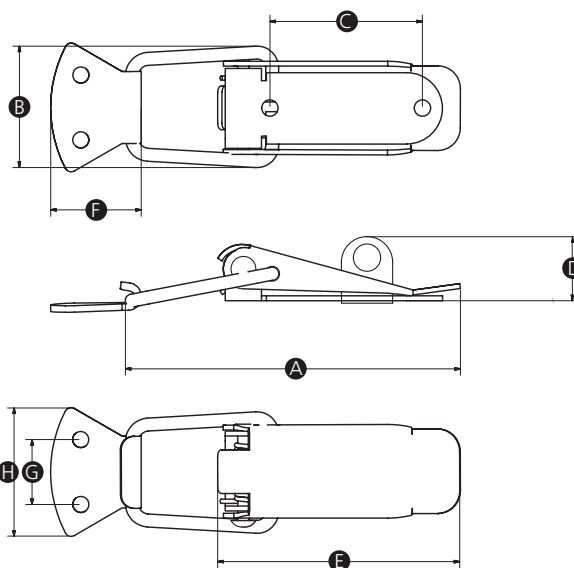

Part No.	A	B	C	D	E	F	G	H	Base hole size	Hook hole size	Locking hole size	Max load (N)
1929631	75	34	33	13	56	20	14	30	4	4	5	500