



## User Manual

### RSDM-906X series

Stock number: 1919720 **RSDM-9061**

1919721 **RSDM-9060**

EN

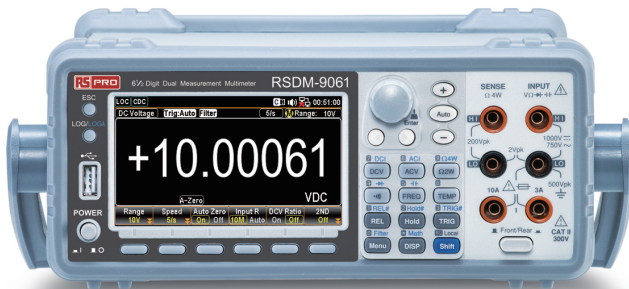

[rspro.com](http://rspro.com)





# Table of Contents

<b>SAFETY INSTRUCTIONS.....</b>	<b>6</b>
<b>GETTING STARTED .....</b>	<b>11</b>
Characteristics .....	12
Front Panel Overview .....	14
Rear Panel Overview .....	20
Status Bar .....	24
Set Up .....	27
<b>BASIC MEASUREMENT.....</b>	<b>29</b>
Basic Measurement Overview .....	30
AC/DC Voltage Measurement .....	34
AC/DC Current Measurement .....	42
2W/4W Resistance Measurement.....	47
Continuity Test.....	51
Diode Measurement .....	54
Frequency/Period Measurement .....	57
Capacitance Measurement .....	63
Temperature Measurement .....	67
<b>DUAL MEASUREMENT .....</b>	<b>78</b>
Dual Measurement .....	79
<b>ADVANCED MEASUREMENT .....</b>	<b>90</b>
Advanced Measurement Overview .....	91
Relative Value Measurement .....	92
Hold Measurement .....	94
Trigger Setting .....	98
Filter Setting .....	104
Math Measurement .....	109



<b>DIGITAL I/O .....</b>	<b>137</b>
Digital I/O Overview .....	138
Application: Compare Mode.....	142
Application: 4094 / User Mode .....	150
Application: External Trigger .....	158
<b>SYSTEM &amp; FIRMWARE .....</b>	<b>160</b>
View System Info .....	161
Firmware Update .....	162
<b>MENU SETTING .....</b>	<b>165</b>
Configure System.....	166
Configure Display .....	189
<b>SCREENHOT &amp; LOG.....</b>	<b>211</b>
Capture .....	212
Save Reading .....	215
<b>DISPLAY SETTING .....</b>	<b>219</b>
Digit .....	220
Display.....	222
<b>REMOTE CONTROL .....</b>	<b>245</b>
Configure Interface .....	246
Command Syntax .....	282
Command Set .....	286
Status system .....	370
<b>APPENDIX .....</b>	<b>375</b>
Fuse Replacement .....	376
Battery Replacement .....	380
Factory Default Parameters .....	382
Specifications .....	387
RSDM-9061 .....	389
RSDM-9060.....	399



Dimensions .....409  
Declaration of Conformity.....410



# SAFETY INSTRUCTIONS

This chapter contains important safety instructions that you must follow when operating the RSDM-9060/9061 and when keeping it in storage. Read the following before any operation to insure your safety and to keep the RSDM-9060/9061 in the best possible condition.

## Safety Symbols

These safety symbols may appear in this manual or on the instrument.

---



**WARNING**

Warning: Identifies conditions or practices that could result in injury or loss of life.



**CAUTION**

Caution: Identifies conditions or practices that could result in damage to the RSDM-9060/9061 or to other objects or property.



**DANGER High Voltage**



Attention: Refer to the Manual



Protective Conductor Terminal



Earth (Ground) Terminal



Do not dispose electronic equipment as unsorted municipal waste. Please use a separate collection facility or contact the supplier from which this instrument was purchased.

## Safety Guidelines

---

### General Guideline



#### CAUTION

- Make sure that the voltage input level does not exceed DC1000V/ AC750V.
- Make sure the current input level does not exceed 10A.
- Do not place heavy objects on the instrument.
- Avoid severe impact or rough handling that may damage the instrument.
- Do not discharge static electricity to the instrument.
- Use only mating connectors, not bare wires, for the terminals.
- Do not block or obstruct the cooling fan vent opening.
- Do not perform measurement at the source of a low-voltage installation or at building installations (Note below).
- Do not disassemble the instrument unless you are qualified as service personnel.
- Make sure that the Sense LO terminal to Input LO is limited to 2Vpk, the Sense HI to Sense LO terminals are limited to 200Vpk and the Input LO to earth is limited to 500Vpk.

(Note) EN 61010-1:2010 specifies the measurement categories and their requirements as follows. The RSDM-9060/9061 falls under category II 300V.

Measurement category IV is for measurement performed at the source of a low-voltage installation.

Measurement category III is for measurement performed in a building installation.

Measurement category II is for measurement performed on circuits directly connected to a low voltage installation.

---

---

Power Supply



WARNING

- AC Input voltage: 100/120/220/240 V AC  $\pm 10\%$ , 50Hz / 60Hz / 400Hz  $\pm 10\%$
  - The power supply voltage should not fluctuate more than 10%.
  - Connect the protective grounding conductor of the AC power cord to an earth ground to prevent electric shock.
- 



WARNING  
(RSDM-9061  
only)

- Due to the fact that the Front/Rear Input Switch on the front panel is not proposed as an active multiplexer, do Not change the input switch when signals are present on either rear or front set of terminals. Intrument damage and risk of electric shock may occur if switching the input switch when high voltage or current is present.
- 

Fuse



WARNING

- Fuse type: T0.25A 100/120 VAC  
T0.125A 220/240 VAC
  - Make sure the correct type of fuse is installed before power up.
  - To avoid risk of fire, replace the fuse only with the specified type and rating.
  - Disconnect the power cord before fuse replacement.
  - Make sure the cause of a fuse blowout is fixed before fuse replacement.
- 

Cleaning the  
function  
generator

- Disconnect the power cord before cleaning.
  - Use a soft cloth dampened in a solution of mild detergent and water. Do not spray any liquid into the RSDM-9060/9061..
  - Do not use chemicals containing harsh products such as benzene, toluene, xylene, and acetone.
-

<p>Operation Environment</p>	<ul style="list-style-type: none"> <li>• Location: Indoor, no direct sunlight, dust free, almost non-conductive pollution (Note below)</li> <li>• Humidity:             <ul style="list-style-type: none"> <li>&lt; 30°C: &lt; 80%RH (non-condensing)</li> <li>30°C~40°C: &lt;70%RH (non-condensing)</li> <li>&gt;40°C: &lt;50%RH (non-condensing)</li> </ul> </li> <li>• Altitude: &lt;2000m</li> </ul> <p>(Note) EN 61010-1:2010 specifies pollution degrees and their requirements as follows. The RSDM-9060/9061 falls under degree 2.</p> <p>Pollution refers to “addition of foreign matter, solid, liquid, or gaseous (ionized gases), that may produce a reduction of dielectric strength or surface resistivity”.</p> <p>Pollution degree 1: No pollution or only dry, non-conductive pollution occurs. The pollution has no influence.</p> <p>Pollution degree 2: Normally only non-conductive pollution occurs. Occasionally, however, a temporary conductivity caused by condensation must be expected.</p> <p>Pollution degree 3: Conductive pollution occurs, or dry, non-conductive pollution occurs which becomes conductive due to condensation which is expected. In such conditions, equipment is normally protected against exposure to direct sunlight, precipitation, and full wind pressure, but neither temperature nor humidity is controlled.</p>
------------------------------	---

<p>Storage environment</p>	<p>Location: Indoor</p> <p>Relative Humidity: -40°C to 70°C</p> <p>Temperature: &lt;90%RH(non-condensing)</p>
----------------------------	---

<p>Disposal</p> 	<p>Do not dispose this instrument as unsorted municipal waste. Please use a separate collection facility or contact the supplier from which this instrument was purchased. Please make sure discarded electrical waste is properly recycled to reduce environmental impact.</p>
---	---

## Power cord for the United Kingdom

When using the function generator in the United Kingdom, make sure the power cord meets the following safety instructions.

---

NOTE: This lead/appliance must only be wired by competent persons



**WARNING: THIS APPLIANCE MUST BE EARTHED**

IMPORTANT: The wires in this lead are coloured in accordance with the following code:

Green/ Yellow:	Earth
Blue:	Neutral
Brown:	Live (Phase)



As the colours of the wires in main leads may not correspond with the coloured marking identified in your plug/appliance, proceed as follows:

The wire which is coloured Green & Yellow must be connected to the Earth terminal marked with either the letter E, the earth symbol  or coloured Green/Green & Yellow.

The wire which is coloured Blue must be connected to the terminal which is marked with the letter N or coloured Blue or Black.

The wire which is coloured Brown must be connected to the terminal marked with the letter L or P or coloured Brown or Red.

If in doubt, consult the instructions provided with the equipment or contact the supplier.

This cable/appliance should be protected by a suitably rated and approved HBC mains fuse: refer to the rating information on the equipment and/or user instructions for details. As a guide, a cable of 0.75mm<sup>2</sup> should be protected by a 3A or 5A fuse. Larger conductors would normally require 13A types, depending on the connection method used.

Any exposed wiring from a cable, plug or connection that is engaged in a live socket is extremely hazardous. If a cable or plug is deemed hazardous, turn off the mains power and remove the cable, any fuses and fuse assemblies. All hazardous wiring must be immediately destroyed and replaced in accordance to the above standard.

# GETTING STARTED

This chapter describes the RSDM-9060/9061 in a nutshell, including an Overview of its main features and front / rear panel introduction. After going through the Overview, follow the Power-up sequence to properly setup the RSDM-9060/9061.

Please note the information in this manual was correct at the time of printing. However as RS PRO continues to improve its products, changes can occur at any time without notice. Please see the RS PRO website for the latest information and content.

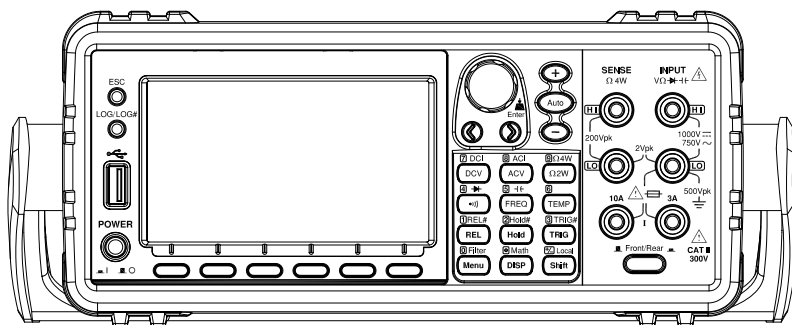

---

Characteristics .....	12
Accessories .....	13
Front Panel Overview .....	14
Measurement Keys (basic) .....	17
Measurement Keys (advanced) .....	18
Rear Panel Overview .....	20
Status Bar .....	24
Set Up .....	27
Horizontal/Tilt/Vertical Applications .....	27
Power Up .....	28

## Characteristics

The RSDM-9060/9061 is a portable, dual-display digital multimeter suitable for a wide range of applications, such as production testing, research, and field verification.

---

- Performance
- The highest DCV accuracy:  
RSDM-9061: 35ppm  
RSDM-9060: 75ppm
  - The highest current:  
RSDM-9061: 10A  
RSDM-9060: 3A
  - The highest voltage: 1000V
  - The highest ACV frequency response: 300 kHz
  - The fastest sampling rate:  
1k Readings/sec (RSDM-9060)  
10k Readings/sec (RSDM-9061)
  - Internal memory:  
10k read memory (RSDM-9060)  
100k read memory (RSDM-9061)
  - Data Logging to USB
- 

- Features
- 6  $\frac{1}{2}$  digits
  - Multi functions: ACV, DCV, ACI, DCI, 2W/4W R, Hz, Temp, Continuity, Diode, Period, Capacitance test, REL, dBm, Hold, MX+B, 1/X, REF%, dB, Compare and Statistics.
  - Manual or Auto ranging
  - AC true RMS
  - Built-in DC Ratio function
  - Standard SCPI command set in emulation compatible with Agilent 34401A
  - Up to 3 temperature measurements: RTD, Thermistor and Thermocouples (Cold-Junction Compensation)
-



	<ul style="list-style-type: none"> <li>Graph Display: BarMeter, TrendChart, Histogram</li> </ul>
Interface	<ul style="list-style-type: none"> <li>USB device/RS232/GPIB(optional)/LAN for remote control</li> <li>9-pin Digital I/O port</li> <li>USB device port supports USBCDC and USBTMC</li> <li>USB Host</li> </ul>
Software	<ul style="list-style-type: none"> <li>Excel Addins</li> <li>DMM-VIEWER2</li> </ul>

## Accessories

Standard Accessories	Part number	Description
	CD-ROM	UM, Software, Driver
	82DM-90610M01	Safety Instruction Sheet
	GTL-217	Test leads
	GTL-246	USB Cable, USB 2.0, A-B type, 1200mm
Optional Accessories	Part number	Description
	11DM-90610101	RSDM-9060/9061 GPIB Card
	GTL-234	RS-232 Cable , 2000mm
	GTL-205A	Temperature Probe Adapter with Thermal Coupling (K-type)
	GTL-308	4W+Shield Test leads, 1.5M
	RSDM-TL1	<ul style="list-style-type: none"> <li>Test lead probes with CAT IV 600V sheath x 2</li> <li>Fine tip probes x 2</li> <li>SMT Grabbers x 2</li> <li>Mini Grabber x 1</li> </ul>

# Front Panel Overview

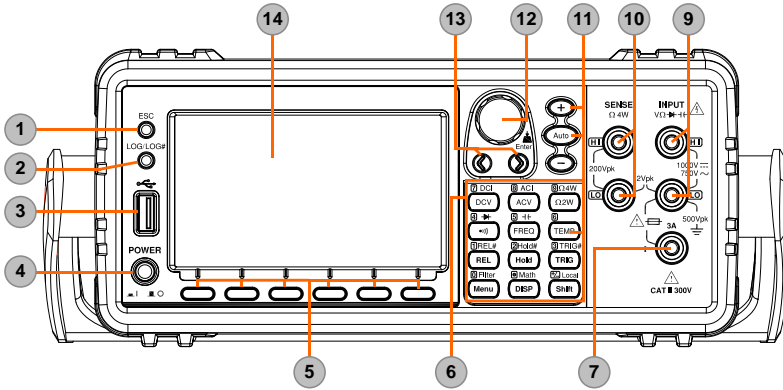

RSDM-9060

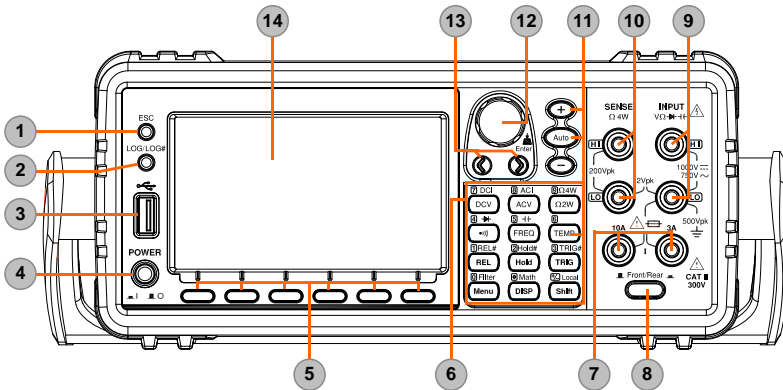

RSDM-9061

Item	Description
1	ESC (Escape) Key
2	Print screen / Data log Key
3	USB Host Port
4	Power Switch

- 5 Function keys (F1 through F6, functions vary per modes)
- 6 Measurement Keys
- 7 AC/DC Current Input Terminals (10 A terminal available on RSDM-9061 only)
- 8 Front/Rear Input Switch (RSDM-9061 only)
- 9 HI and LO Input Terminals
- 10 HI and LO Input Terminals
- 11 Range Selection Keys
- 12 Knob key
- 13 Arrow Keys
- 14 Main Display

ESC (Escape) Key  Single press to escape from current page. Presses and holds the ESC key for 2 seconds to toggle between full display and simple display, which conceals the status bar, math display as well as additional info for lightweight use.



---



Screenshot / Data Log Saving Key  LOG/LOG# Captures the current screenshot or saves the data log for reading.

---

USB Host Port  Connects with USB flash drive for data storage.

---





Power Switch  Turns On  or Off  the main power. For the power up sequence.

---

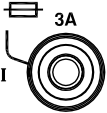

Main Display The 4.3" TFT LCD shows measurement results and parameters.

---

Measurement Keys	There are 4 rows in total of both basic and advanced measurement keys deployed on the front panel.	
Function Keys	The 6 keys have varied functions per different settings.	
Knob Key		Scrolls the knob to select parameters in various setting pages. Press the key until click to confirm setting.
Arrow Keys		Presses the left or right arrow keys to move parameter cursor rightward or leftward per requirement.
Range Selection Keys		Presses the Auto key to activate auto-range mode, whilst clicking "+" or "-" key can increase or decrease range parameter, respectively.
DC/AC 3A Terminal		DC/AC current input DC: 100 $\mu$ A~3A AC: 100 $\mu$ A~3A For the fuse replacement procedure.
Sense LO Terminal		Accepts LO sense line in 4W resistance measurement.
Sense HI Terminal		Accepts HI sense line in 4W resistance measurement.



Input LO Terminal		<p>Accepts ground (COM) line in all measurements except the sense line in 4W Resistance.</p> <p>The maximum withstand voltage between this terminal and earth is 500Vpk.</p>
Input HI Terminal		<p>Used as an input port for all measurements except for DC/AC Current measurements.</p>
DC/AC 10A Terminal (RSDM-9061 only)		<p>Accepts DC/AC Current input.</p> <p>For DCI or ACI details.</p>

## Measurement Keys (basic)

Background	<p>The upper 2 rows of measurement keys are used for basic RSDM-9060/9061 measurements such as voltage, current, resistance, continuity, diode, frequency, period, capacitance and temperature. Each key has a primary and secondary function individually. The secondary function is accessed in conjunction with the Shift key.</p>
Shift	 <p>The Shift key is used to select the secondary functions assigned to each front panel key. When pressed, the Shift indicator appears in the display.</p>
Local	 <p>For the Local key, it helps release from the remote control and returns the instrument to local panel operation.</p>
ACV	 <p>Measures AC Voltage.</p>

Shift → ACV (ACI)  →  Measures AC Current

DCV  Measures DC Voltage.

Shift → DCV (DCI)  →  Measures DC Current



$\Omega 2W$  (Resistance)  Measures 2-wire Resistance.

Shift →  $\Omega 2W$  ( $\Omega 4W$  Resistance)  →  Measures 4-wire Resistance.

•|) (Continuity)  Tests Continuity.

Shift → •|) (Diode  $\rightarrow \nabla$ )  →  Tests Diode.

FREQ (Frequency)  Measures Frequency

Shift + FREQ (Capacitance  $\nabla \nabla$ )  →  Measures Capacitance.













TEMP (Temperature)  Measures Temperature.

## Measurement Keys (advanced)

**Background** The lower 2 rows of measurement keys are used for more advanced functions. Each key has a primary and secondary function. The secondary function is accessed in conjunction with the Shift key.

REL  Measures the Relative value

Shift → REL (REL#)  →  Manually sets the reference value for the Relative value measurement.

Hold		Activates the Hold function.
Shift → Hold (Hold#)	 → 	Manually sets the parameters for the Hold measurement.
TRIG (Trigger)		Activates the Trigger function.
Shift → TRIG (TRIG#)	 → 	Manually sets the parameters for the Trigger function.
Menu		Enters the setting pages in various Menus.
Shift → Menu (Filter)	 → 	Manually sets the parameters for the Filter function.
DISP		Display settings.
Shift → DISP (Math)	 → 	The Math functions including dB, dBm, Compare, MX+B, 1/X and Percent manually.

# Rear Panel Overview

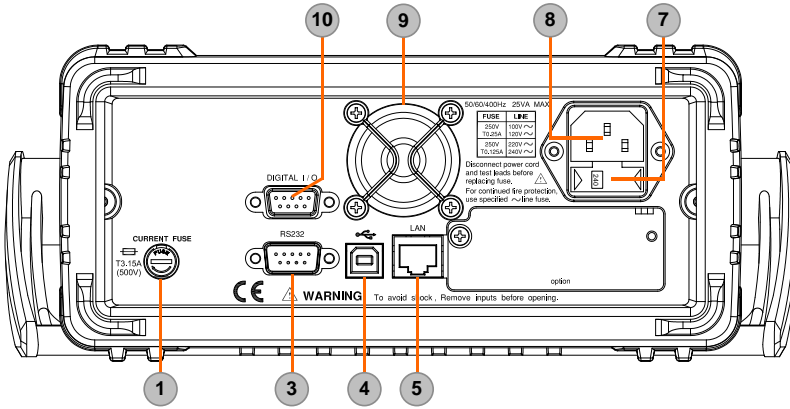

RSDM-9060

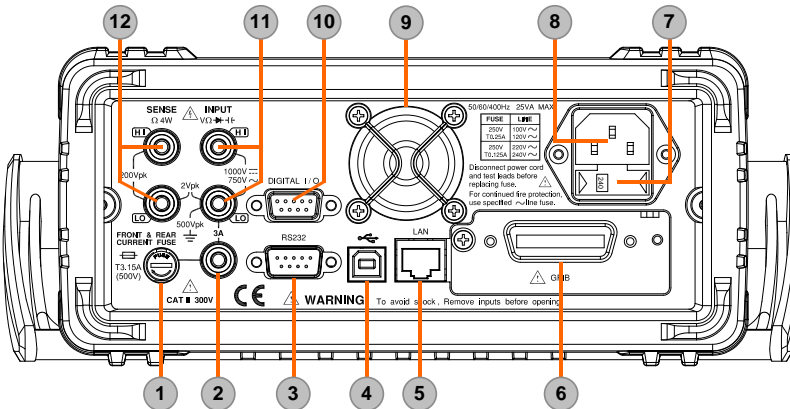

RSDM-9061

Item	Description
1	3A Current Terminal Fuse
2	3A Current Terminal (RSDM-9061 only)
3	RS-232 Interface Connector
4	USB Interface Connector (B Type)



- 5 Ethernet (LAN) Connector
- 6 GPIB Connector (optional)
- 7 AC Mains Line Voltage Selector and Fuse Socket
- 8 AC Mains Input (Power Cord Socket)
- 9 Fan Vents
- 10 DIGITAL I/O Connector
- 11 HI and LO Input Terminals (RSDM-9061 only)
- 12 HI and LO Sense Terminals (RSDM-9061 only)

Power Cord Socket

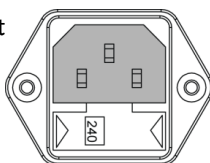

Accepts the power cord. AC 100/120/220/240V  $\pm 10\%$ , 50Hz / 60Hz / 400Hz  $\pm 10\%$ .

For power on sequence.

Fuse Socket

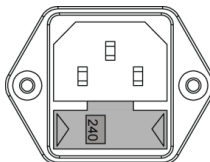

Holds the main fuse:

100/120 VAC: T0.25A

220/240 VAC: T0.125A

For fuse replacement details.

RS-232C port

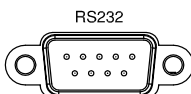

Accepts an RS-232C cable for remote control; DB-9 male connector.

For remote control details.

USB device port

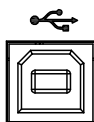

Accepts a USB device cable for remote control; Type B, female connector.

For remote control details.

LAN port



Accepts a LAN for remote control;

For remote control details.

Digital I/O port

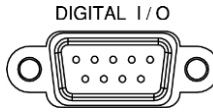

Accepts a digital I/O cable for the Hi/Lo limit tests; DB-9 pin, female connector.

For digital I/O details.

Optional GPIB port

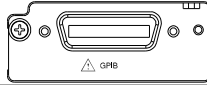

Accepts an optional GPIB card.

For GPIB details.

Fan Vents

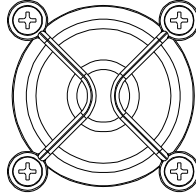

For heat ventilation when machine is under operation.

Sense LO Terminal  
(RSDM-9061 only)



Accepts LO sense line in 4W resistance measurement.

Sense HI Terminal  
(RSDM-9061 only)



Accepts HI sense line in 4W resistance measurement. For details.

Input LO Terminal  
(RSDM-9061 only)



Accepts ground (COM) line in all measurements except the sense line in 4W Resistance . The maximum withstand voltage between this terminal and earth is 500Vpk.

Input HI Terminal (RSDM-9061 only)

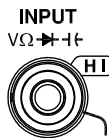

Used as an input port for all measurements except for DC/AC Current measurements.

DC/AC 3A Terminal (RSDM-9061 only)

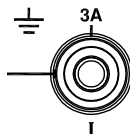

DC/AC current input

DC: 100μA~3A

AC: 100μA~3A

---

DC/AC 3.15A  
Input Current  
Fuse

FRONT & REAR  
CURRENT FUSE

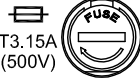

T3.15A  
(500V)

Holds the current fuse: T3.15A,  
500V , 5\*20mm



For fuse replacement details.





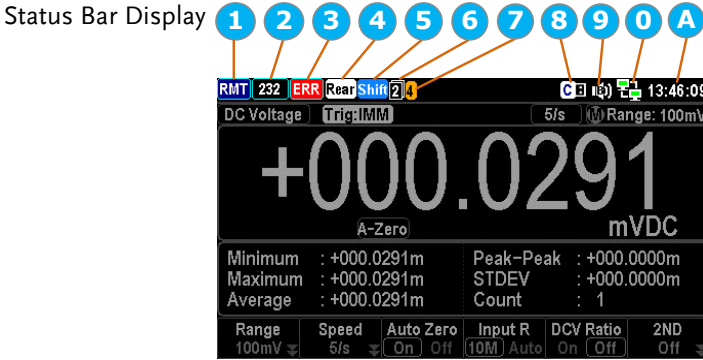







---

# Status Bar









Background Identify each icon within the top status bar.



Item	Description
1	Local/Remote control icon
2	RS-232/USB-CDC/USB-TMC/LAN/GPIB interface icon
3	Error icon for commands from remote control
4	Rear panel switch icon
5	Shift key identification icon
6	The first and second function menu switch icon
7	Digital I/O mode icon (User/4094)
8	USB flash drive connection icon
9	Beep/Key Sound setting icon
0	Internet connection status icon
A	Time display
Local Control	 It indicates the unit is under local control mode.
Remote Control	 It indicates the unit is under remote control.

RS-232		It indicates RS-232 interface is activated.
USB - CDC		It indicates USB - CDC interface is activated.
USB - TMC		It indicates USB - TMC interface is activated.
LAN		It indicates LAN interface is activated.
GPIB		It indicates GPIB interface is activated.
ERROR		It indicates error occurs in commands. To erase the error icon, it is required to read or sweep the error by remote control commands or reboot action.
Rear Panel		It indicates rear panel control. When the icon appears, only rear panel is available; otherwise, use front panel for measurement.
Shift		It indicates the shift key is being pressed ready for in conjunction with other keys for additional functions.
First function menu		It indicates the active bottom menu corresponding to function keys is the first menu. Click the Knob key (Enter) to switch to the second function menu.
Second function menu		It indicates the active bottom menu corresponding to functional keys is the second menu. Click the Knob key (Enter) to switch to the first function menu.
Digital I/O – 4094 mode		It indicates Digital I/O – 4094 mode is enabled.
Digital I/O – User mode		It indicates Digital I/O – User mode is enabled.
Flash Drive – Capture		It indicates the Capture mode is ready for the connected flash drive.

---

Flash Drive – Save Reading		It indicates the Save Reading mode is ready for the connected flash drive.
Flash Drive – Failure		It indicates something error occurs and thus flash drive fails to connect to unit.
Sound – Beep		It indicates sound of beep is enabled.
Sound - Key		It indicates sound of key is enabled.
Sound – All		It indicates sounds of beep and key are both enabled.
Sound – Off		It indicates sounds of beep and key are both disabled.
Internet On		It indicates internet connection is established.
Internet Off		It indicates internet connection is Not well established.
Time Display		It indicates the time display. For detailed setting.

---

# Set Up

## Horizontal/Tilt/Vertical Applications

---

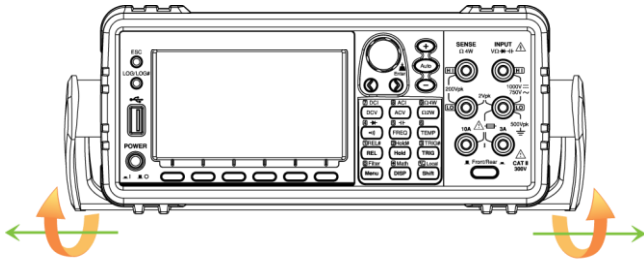

Pull out the handle sideways and rotate it clockwise for the applications below.

---

### Horizontal

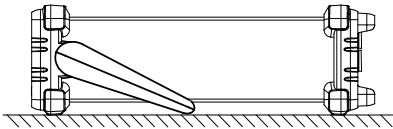

Place the unit horizontally.

### Tilt

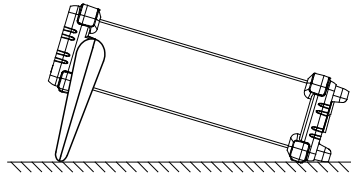

Rotate the handle for tilt stand.

### Vertical

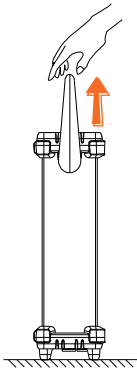

Place the handle vertically for hand carry.

---

## Power Up

### Steps

1. Ensure the correct line voltage is clearly shown on the fuse socket (240V in the right figure for example). If not, see page 351 to set the proper line voltage and fuse.

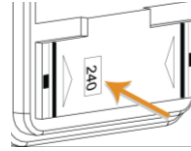

2. Connect the power cord to the AC Voltage input.

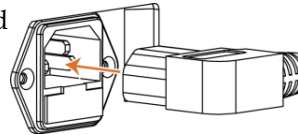

### Note

Make sure the ground connector on the power cord is connected to a safety ground. This will affect the measurement accuracy.

3. Push the power button until click to turn on the main power switch on the front panel.

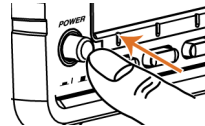

4. The screen firstly shows the logo brand of RS PRO followed by the message "Load the default parameter" indicating default parameter is loaded in the initial startup.

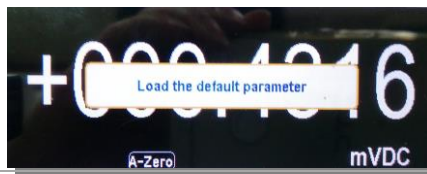



# BASIC MEASUREMENT

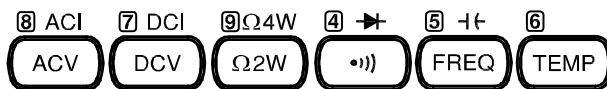

---

Basic Measurement Overview .....	30
Refresh Rate .....	30
Automatic (Internal)/Single Triggering.....	32
AC/DC Voltage Measurement .....	34
Select Voltage Range .....	35
General Voltage Setting .....	36
Voltage Conversion Table.....	40
Crest Factor Table.....	41
AC/DC Current Measurement .....	42
Select Current Range .....	43
General Current Setting.....	45
2W/4W Resistance Measurement .....	47
Select Resistance Range .....	48
General Resistance Setting.....	49
Continuity Test .....	51
Set Continuity Threshold .....	53
Diode Measurement.....	54
Frequency/Period Measurement.....	57
Frequency/Period In-Depth Setting.....	60
Capacitance Measurement .....	63
Cable Open Function.....	64
Select Capacitance Range.....	65
Temperature Measurement .....	67
General Temperature Setting .....	68
Thermocouple Sensor Type.....	69
Reference Junction Temperature (SIM Temperature) .....	70
Thermocouple Setting .....	70
RTD 2W/4W Setting.....	72
Set User Type of RTD 2W/4W .....	73
Thermistor 2W/4W Setting.....	75
Set User Type of Thermistor 2W/4W .....	76

## Basic Measurement Overview

**Background** Basic measurement refers to the several types of measurements assigned to the upper 2 row keys on the front panel.



Measurement type	ACV	AC Voltage
	DCV	DC Voltage
	ACI	AC Current
	DCI	DC Current
	Ω 2W/ Ω 4W	2-wire and 4-wire Resistance
	•)) →+	Continuity/Diode
	FREQ →←	Frequency/Capacitance
	TEMP	Temperature

**Advanced measurement** Advanced measurement mainly refers to the operation using the result obtained from one or more of the basic measurements.

## Refresh Rate

**Background** Refresh rate defines how frequently the RSDM-9060/9061 captures and updates measurement data. A faster refresh rate yields a lower accuracy and resolution. A slower refresh rate yields a higher accuracy and resolution. Consider these tradeoffs when selecting the refresh rate.

Measurement Type	Refresh Rate Available
DCV/DCI/ 2W/4W	5/s, 20/s, 60/s, 100/s, 400/s, 1k/s <sup>*1</sup> , 1.2k/s <sup>*2</sup> , 2.4k/s <sup>*2</sup> , 4.8k/s <sup>*2</sup> , 7.2k/s <sup>*2</sup> , 10k/s <sup>*2</sup>
ACV/ACI	1/s, 5/s, 20/s

Continuity / Diode 60/s, 100/s, 400/s

Frequency & Period 1s, 100ms, 10ms

Capacitance 2/s

Temperature 5/s, 20/s, 60/s



Note

\*1 is applicable to RSDM-9060, whilst \*2 is specifically for RSDM-9061.

Selection Procedure

Press the left or right arrow keys to change the refresh rate.



You can also press the F2 (Speed) key **Speed** to select a desired rate for measurement. Press corresponding function key in accord with the desired option on screen display.

Also, the F6 (More 1/2) key shows **More 1/2** when available options are more than single page.



The refresh rate will be shown at the upper right corner of the display. See the example below.

### Active Refresh Rate

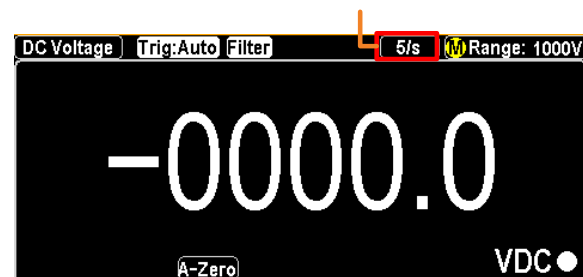

Note

The refresh rate cannot be set for capacitance measurement.

Reading indicator The reading indicator , which is located in the lower-right corner of display, flashes according to the defined refresh rate setting.

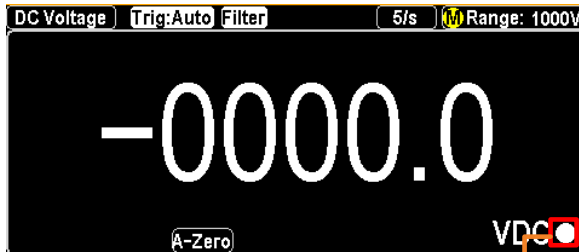

Reading Indicator

## Automatic (Internal)/Single Triggering

**Overview** By default, the RSDM-9060/9061 automatically triggers according to the refresh rate. See the previous page for refresh rate setting details. The TRIG key, on the other hand, is used to manually trigger once per click.

**Single Trigger** Simply press the TRIG key to Single trigger measurement. Pressing once stands for trigger for single time. See the figure below for example.



Indicator Single Trigger Mode

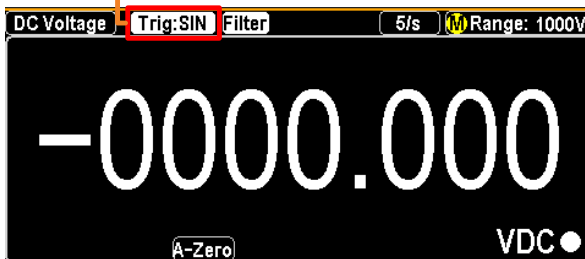

Automatic  
(Internal) Trigger

Press and hold the TRIG key for 2 seconds to return to the Automatic (Internal) Trigger.



(Press & hold for 2 seconds)

Indicator Auto (Internal)  
Trigger Mode

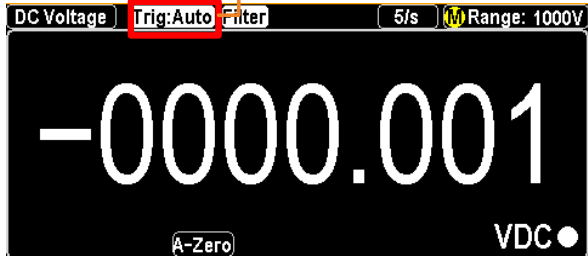



Note

Single triggering is not supported for capacitance measurements.

# AC/DC Voltage Measurement

Voltage type	AC	0 ~ 750V
	DC	0 ~ 1000V

Activate ACV/DCV Press the ACV key or DCV key to  ACI  DCI measure AC or DC voltage, respectively.

ACV/DCV mode display appears The mode will switch to ACV, DCV mode immediately. See the figure below for example.

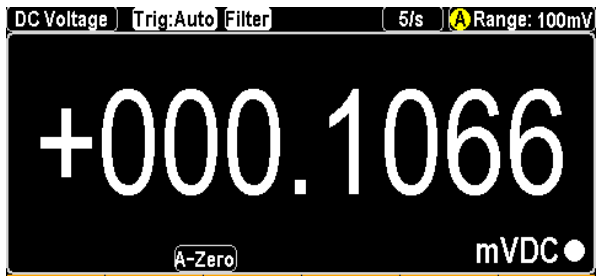

DC or AC Voltage	Indicates DC or AC Voltage mode
5/s	Indicates the active refresh rate
	Indicates Automatic range selection
Range: 100mV	Indicates the available range of Voltage
+000.1066 mVDC	Indicates the exact measured value

Connect the test lead and measure between the Input HI and Input LO terminals. The display updates the reading.

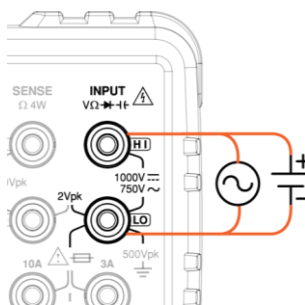

## Select Voltage Range

Auto range

To turn the automatic range selection On/Off, press the Auto key.



Manual range

Press the "+" or the "-" key to select the range. The Auto indicator **A** turns to **M** indicating Manual range selection.



If the appropriate range is unknown, select the highest range.

You can also press the F1 (Range) key to select a range for the measurement.



Press the F1 ~ F6 key to select a desired range for the voltage measurement.

Range					ESC:Return
Auto	100mV	1V	10V	100V	1000V

Selection list

Range	Resolution	Full scale
100mV	0.1μV	119.9999mV
1V	1 μV	1.199999 V
10V	10 μV	11.99999 V
100V	100 μV	119.9999 V
750V (AC)	1mV	787.500 V
1000V (DC)	1mV	1050.000 V



Note

For more detailed parameters, see the specifications on page 353.

## General Voltage Setting

F2 (Speed) key to DCV:  
select refresh rate



Press the F1 ~ F5 key to select the desired rate.



Press the F6 (More 1/2) key for next page with more options as the figure shown below.



ACV:

Press the F1 ~ F3 key to select the desired rate



F3 (Auto Zero) key Background to enable Auto Zero (DCV mode only)

Autozero provides the most accurate measurements, but requires additional time to perform the zero measurement. With autozero enabled (On), the RSDM-9060/9061 internally measures the offset following each measurement. It then subtracts that measurement from the preceding reading. This prevents offset voltages present on the RSDM-9060/9061's input circuitry





from affecting measurement accuracy. With autozero disabled (Off), the RSDM-9060/9061 measures the offset once and subtracts the offset from all subsequent measurements.

Display When turning On the Auto Zero, the display shows an icon  indicating the Auto Zero mode is currently being activated.

F4 (Input R) key to Background select input resistance

Specify the input impedance to the test leads (Input R). This specifies the measurement terminal input impedance, which is either Auto or 10 M $\Omega$ .



The Auto mode selects high impedance (Hi-Z) for the 100mV, 1 V and 10 V ranges, and 10 M $\Omega$  for the 100 V and 1000 V ranges. In most situations, 10 M $\Omega$  is high enough to not load most circuits, but low enough to make readings stable for high impedance circuits. It also leads to readings with less noise than the (Hi-Z) option, which is included for situations where the 10 M $\Omega$  load is significant.

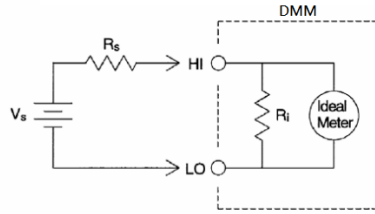

$V_s$  = ideal voltage of DUT

$R_s$  = input impedance of DUT

$R_i$  = input impedance of RSDM-9060/9061 (either 10M or 10G available (Hi-Z))

$$\text{Deviation (\%)} = R_s / (R_s + R_i) * 100$$

**Display** When “Auto” is selected, the display shows an icon  indicating the Auto mode is currently being activated.

**F5 (DCV Ratio)** Background key to enable DCV Ratio

The RSDM-9060/9061 is able to calculate DCV ration by measuring input voltage from the Input terminals and the reference voltage from the Sense terminals. Before activating the DCV Ration, it is required to wire test leads as the following illustration.

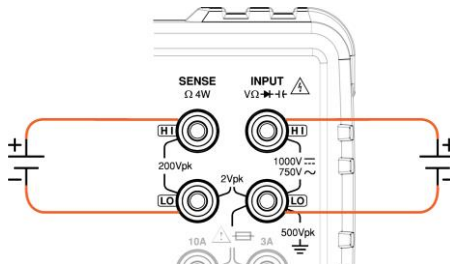

The equation of DCV ratio is like the following mathematical calculation:

$$\text{DCV RATIO} = \frac{\text{DC Input Voltage}}{\text{DC Reference Voltage}}$$

See the above equation from which DC Reference Voltage indicates the measured voltage from the Sense terminals.

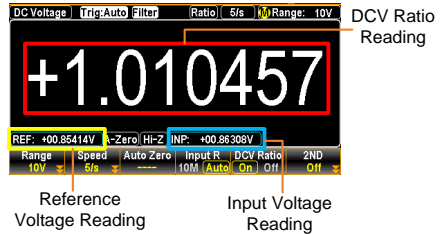

Display



From the screenshot above for example, the INP: +00.86308V (input voltage) is divided by the REF: +00.85414V (reference voltage), and the result turns out the DCV ratio: +1.010457 shown in giant reading clearly.



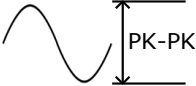

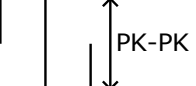
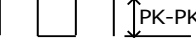
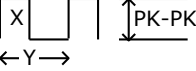
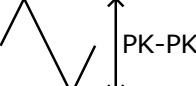

## Voltage Conversion Table

Background This table shows the relationship between AC and DC reading in various waveforms.

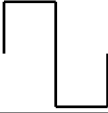
Waveform	Peak to Peak	AC (True RMS)	DC
Sine 	2.828	1.000	0.000
Rectified Sine (full wave) 	1.414	0.435	0.900
Rectified Sine (half wave) 	2.000	0.771	0.636
Square 	2.000	1.000	0.000
Rectified Square 	1.414	0.707	0.707
Rectangular Pulse 	2.000	$2K$ $K = \sqrt{(D - D^2)}$ $D = X/Y$	$2D$ $D = X/Y$
Triangle Sawtooth 	3.464	1.000	0.000

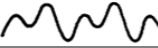
## Crest Factor Table

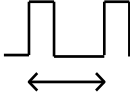
**Background** Crest factor is the ratio of the peak signal amplitude to the RMS value of the signal. It determines the accuracy of AC measurement. If the crest factor is less than 3.0, voltage measurement will not result in error due to dynamic range limitations at full scale. If the crest factor is more than 3.0, it usually indicates an abnormal waveform as seen from the below table.

Waveform	Shape	Crest factor
Square wave		1.0
Sine wave		1.414
Triangle sawtooth		1.732
Mixed frequencies		1.414 ~ 2.0
SCR output 100% ~ 10%		1.414 ~ 3.0
White noise		3.0 ~ 4.0
AC Coupled pulse train		>3.0
Spike		>9.0

# AC/DC Current Measurement

**Background** The RSDM-9061, with front/rear input terminals, has two input terminals for current measurement: the 3A terminal for current less than 3A and a 10A terminal for measurements up to 10A, which can measure between 3 ~ 10A for both AC and DC current. On the other hand, for the RSDM-9060, which has no rear input terminals, nor 10A terminal, it offers merely a 3A terminal for current measurement less than 3A.

Current type	RSDM-9060	AC/DC 3A
	RSDM-9061	AC/DC 3A/10A

**Activate ACI/ DCI Measure** Press the Shift → ACV or Shift → DCV key to measure AC or DC current, respectively.

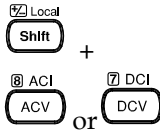

**ACI/DCI mode display appears** The measurement will switch to ACI, DCI mode immediately. See the figure below for example.

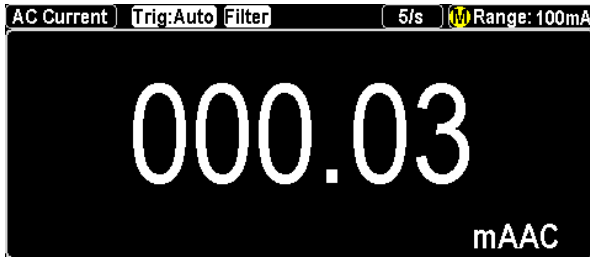

AC or DC Current Indicates DC or AC Current mode

5/s Indicates the active refresh rate

 Indicates Automatic range selection

Range: 100mA Indicates the available range of Current

000.03 mAAC Indicates the exact measured value

Connect the test lead and measure between the 3A terminal and the Input LO terminal or DC/AC 10A terminal and the Input LO terminal, depending on the input current.

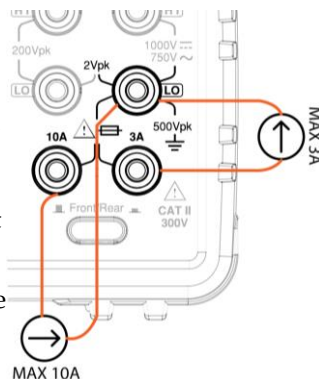

The display updates the reading. For current  $\leq$  3A use the 3.15A terminal.

For current up to 12A use the 10A terminal.

## Select Current Range

Auto range

To turn the automatic range selection On/Off, press the AUTO key. The most appropriate range for the currently used input jack will be automatically selected. The RSDM-9060/9061 is able to do this by remembering the last manually selected range and using that information to determine the smallest current range that the auto-range function will switch to. When the current input is switched to another terminal, the range must be manually set.



Note

Auto Range not allowed on 10A

### Manual range

Press the “+” or the “-” key to select the range. The AUTO indicator turns to indicating Manual range selection.

If the appropriate range is unknown, select the highest range.

You can also press F1 (Range) key to select a range for the measurement.

Press the F1 ~ F5 key to select a desired range for the measurement.



Press the F6 (More 1/2) key for next page with more options as the figure shown below.



### Selectable Current Ranges

Range	Resolution	Full scale	INJACK
100μA	0.1nA	119.9999 μA	3A
1mA	1nA	1.199999 mA	3A
10mA	10nA	11.99999 mA	3A
100mA	100nA	119.9999mA	3A
1A	1μA	1.199999 A	3A
3A	1μA	3.150000 A	3A
10A	10μA	10.50000 A	10A



Note

For further details, see the specifications on page 353.



## General Current Setting

F2 (Speed) key to select the rate

DCI:

Speed

Press the F1 ~ F5 key to select the desired rate



Press the F6 (More 1/2) key for next page with more options as the figure shown below.

More 1/2



ACI:

Press the F1 ~ F3 key to select the desired rate



F3 (Auto Zero) key to enable Auto Zero (DCI mode only)

Background Autozero provides the most accurate measurements, but requires additional time to perform the zero measurement. With autozero enabled (On), the RSDM-9060/9061 internally measures the offset following each measurement. It then subtracts that measurement from the preceding reading. This prevents offset voltages present on the RSDM-9060/9061's input circuitry from affecting measurement accuracy. With autozero disabled (Off), the RSDM-

Auto Zero  
On Off

---

9060/9061 measures the offset once and subtracts the offset from all subsequent measurements.

---

Display      When turning On the Auto Zero, the display shows an icon  indicating the Auto Zero mode is currently being activated.

---

## 2W/4W Resistance Measurement

Measurement type	2-wire OHM Uses the standard Input HI-LO terminals. Recommended for measuring resistances larger than 1k $\Omega$ .
	4-wire OHM Compensates the test lead effect using the 4W compensation terminals (SENSE HI/LO terminals), in addition to the standard Input HI-LO terminals. Recommended for measuring sensitive resistances smaller than 1k $\Omega$ .

Activate 2W or 4W Measurement	Press the $\Omega$ 2W key to activate 2W resistance measurement.	
	Press the Shift $\rightarrow$ $\Omega$ 2W key to activate 4W resistance measurement.	+

2W/4W resistance mode display appears The mode will switch to the selected resistance mode immediately. Press the Shift  $\rightarrow$  $\Omega$ 2W key on the front panel as figure shown below.

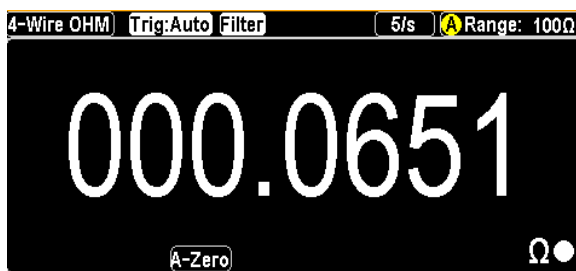

2 or 4-Wire OHM Indicates 2W or 4W Resistance mode

5/s Indicates the active refresh rate

Indicates Automatic range selection

Range: 100  $\Omega$  Indicates the available range of Resistance

000.0651  $\Omega$  Indicates the exact measured value

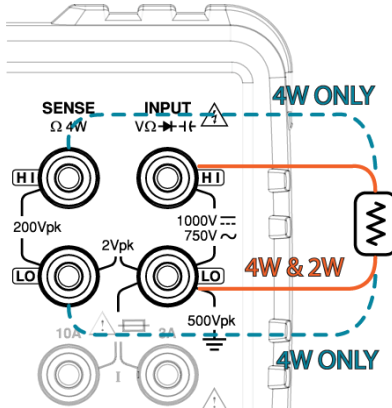

Connect the test lead and measure For 2W measurement, connect the test leads between the Input HI terminal and the LO terminal.

For 4W measurement, connect the test leads between the Input HI terminal and the LO terminal, as the way to 2W measurement. Also, connect another sense leads between the SENSE LO and HI terminals.



## Select Resistance Range

Auto range To turn the automatic range selection On/Off, press the Auto key. 

Manual range Press the "+" or the "-" key to select the range. The Auto indicator  turns to  indicating Manual range selection. If the appropriate range is unknown, select the highest range. 

You can also press the F1 (Range) key to select a range for the measurement. 

Press the F1 ~ F5 key to select a desired range for the measurement.



Press the F6 (More 1/2) key for next page with more options as the figure shown below.

**More 1/2**

		Range			ESC:Return
		1MΩ	10MΩ	100MΩ	Page Up
Selectable Resistance Ranges	Range	Resolution	Full scale		
	100Ω	0.1mΩ	119.9999Ω		
	1kΩ	1mΩ	1.199999kΩ		
	10kΩ	10mΩ	11.99999kΩ		
	100kΩ	100mΩ	119.9999kΩ		
	1MΩ	1Ω	1.199999MΩ		
	10MΩ	10Ω	11.99999MΩ		
	100MΩ	100Ω	119.9999MΩ		



Note

For more details, see the specifications on page 353.

## General Resistance Setting

F2 (Speed) key to select the rate Press the F1 ~ F5 key to select the desired rate

**Speed**

Speed					ESC:Return
5/s	20/s	60/s	100/s	400/s	More 1/2

Press the F6 (More 1/2) key for next page with more options as the figure shown below.

**More 1/2**

Speed					ESC:Return
1.2k/s	2.4k/s	4.8k/s	7.2k/s	10k/s	Page Up

F3 (AutoZero) key Background to enable Auto Zero

Autozero provides the most accurate measurements, but requires additional time to perform the zero measurement. With autozero enabled (On), the RSDM-9060/9061 internally

**Auto Zero**  
On Off



---

measures the offset following each measurement. It then subtracts that measurement from the preceding reading. This prevents offset voltages present on the RSDM-9060/9061's input circuitry from affecting measurement accuracy. With autozero disabled (Off), the RSDM-9060/9061 measures the offset once and subtracts the offset from all subsequent measurements.

---

Display	When turning On the Auto Zero, the display shows an icon  indicating the Auto Zero mode is currently being activated.
---------	--



---

# Continuity Test

---

**Background**      The continuity test checks that the resistance in the DUT is low enough to be considered continuous (of a conductive nature).

---

**Activate continuity test**      Press the  key to activate continuity testing. 

---

**Continuity mode display appears**      The mode will switch to continuity testing immediately. Press  on the front panel as figure shown below.



**Continuity**      Indicates Continuity measurement

---

**60/s**      Indicates the active refresh rate

---

**M**      Indicates Manual range selection

---

**1kΩ**      Indicates the available range of Continuity

---

 **Note**      The range selection is fixed in 1kΩ

---

**OPENΩ**      Indicates the currently measured result

---

Connect the test lead and measure between the Input HI terminal and the LO terminal. The display updates the reading.

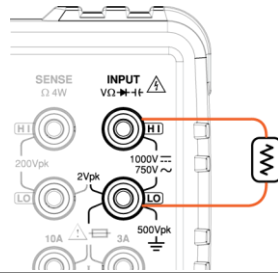

F2 (Speed) key to select the rate. Press the F1 ~ F3 key to select the desired rate



F3 (Auto Zero) key to enable Auto Zero

Background Autozero provides the most accurate measurements, but requires additional time to perform the zero measurement. With autozero enabled (On), the RSDM-9060/9061 internally measures the offset following each measurement. It then subtracts that measurement from the preceding reading. This prevents offset voltages present on the RSDM-9060/9061's input circuitry from affecting measurement accuracy. With autozero disabled (Off), the RSDM-9060/9061 measures the offset once and subtracts the offset from all subsequent measurements.





**Display** When turning On the Auto Zero, the display shows an icon **A-Zero** indicating the Auto Zero mode is currently being activated.

**F4 (BeepVol) key to select the Vol** Press the F2 ~ F4 key to select the volume level or press the F1 key to set Beep volume off



## Set Continuity Threshold

**Background** The continuity threshold defines the maximum resistance allowed in the DUT when testing the continuity.

**Threshold Range** **Threshold** 1 to 1000Ω (Default Threshold:10Ω)  
**Resolution** 1Ω

**Procedure** Press the F5 key to enter the Threshold of Continuity menu as the figure below shown.



Set the continuity threshold level.



1. Use the Left/Right arrow keys to move cursor and scroll the Knob key or press Number keys to enter the desired value.



2. Press the F6 (Enter) key or the Knob key until click to confirm the threshold settings.

**Display** **CONT Threshold** **Ω** 0100 24 (ESC):Return Enter

# Diode Measurement

---

**Background** The diode test checks the forward bias characteristics of a diode by running a constant forward bias current of approximately 1mA through the DUT.

---

**Activate diode test**  Press the Shift+  key to  Local Shift +  Shift to activate diode measurement.

---

**Diode mode display appears** The screen will switch to Diode mode immediately as the figure shown below.

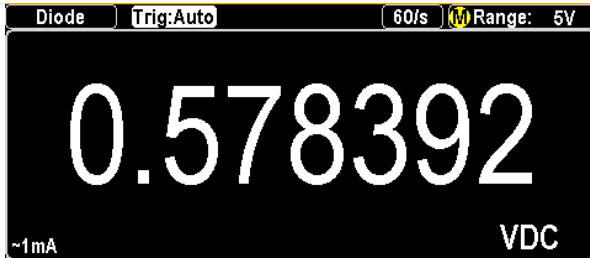

**Diode** Indicates the Diode measurement

---

**60/s** Indicates the active refresh rate

---

 Indicates Manual range selection

---

**5V** Indicates the available range of Diode

---

 **Note** The range selection is fixed in 5V

---

**0.449395 VDC** Indicates the exact measured value

---

Connect the test lead and measure between the Input HI terminal and the LO terminal; Anode-V, Cathode-COM. The display updates the reading.

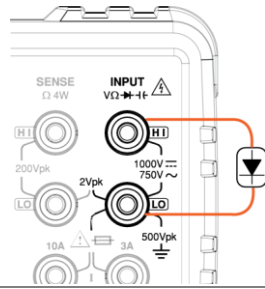

F2 (Speed) key to select the rate. Press the F1 ~ F3 key to select the desired rate



F3 (Auto Zero) key to enable Auto Zero

Background Autozero provides the most accurate measurements, but requires additional time to perform the zero measurement. With autozero enabled (On), the RSDM-9060/9061 internally measures the offset following each measurement. It then subtracts that measurement from the preceding reading. This prevents offset voltages present on the RSDM-9060/9061's input circuitry from affecting measurement accuracy. With autozero disabled (Off), the RSDM-9060/9061 measures the offset once and subtracts the offset from all subsequent measurements.



---

Display      When turning On the Auto Zero, the display shows an icon  indicating the Auto Zero mode is currently being activated.



---



# Frequency/Period Measurement

**Description** The RSDM-9060/9061 can be used to measure the frequency or period of an input signal.

<b>Range</b>	<b>Frequency</b>	3Hz ~1MHz
	<b>Period</b>	1.0μs ~333ms

**Activate frequency or period test**

- To measure Frequency, press the  FREQ key followed by clicking the F3 (Measure) key to enter the Measure menu. Click the F1 (Frequency) key and the measured frequency will be displayed on the primary screen with the period value displayed on the sub section beneath.  

- To measure Period, press the FREQ  key followed by clicking the F3 (Measure) key to enter the Measure menu. Click the F2 (Period) key and the measured period will be displayed on the primary screen with the frequency value displayed on the sub section beneath.  

**Display** **Frequency Mode**

Indicator Frequency Mode

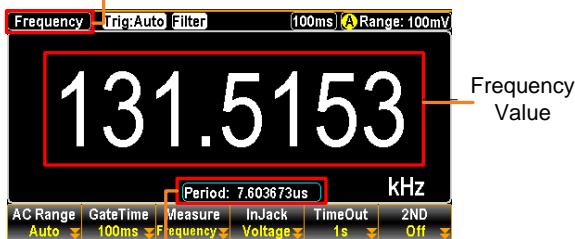

Period Value in Sub Section



## Period Mode

Indicator Period Mode

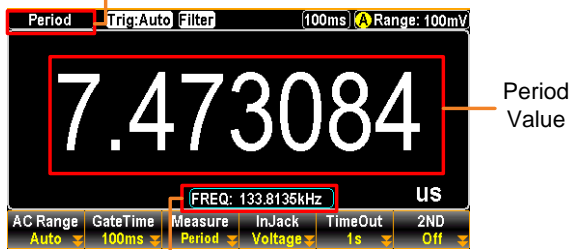

Frequency Value in Sub Section

Frequency mode display appears

The mode will switch to the Frequency or Period mode

immediately. Press  on the front panel followed by clicking F3 key to choose Frequency as shown below.

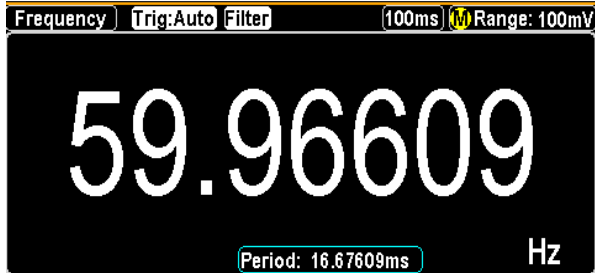

Frequency Indicates Frequency measurement

100ms Indicates the active refresh rate

 Indicates Manual range selection

100 mV Indicates the available range of Voltage

59.96609 Hz Indicates the exactly measured Frequency value

16.67609ms Indicates the exactly measured Period value

## Connection

Depending on different inputs, connect test lead to varied terminals. In terms of voltage, connect test leads between the Input HI terminal and the LO terminal. The display updates the reading.

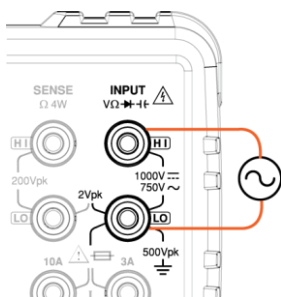

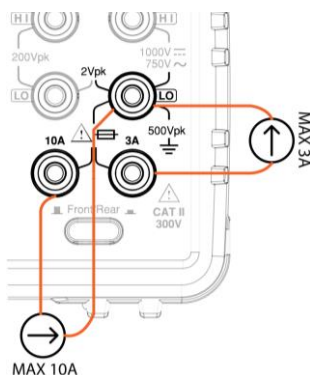

In terms of current, connect test leads between the 3A terminal and the LO terminal or DC/AC 10A terminal (RSDM-9061 only) and the LO terminal. The display updates the reading.



## Frequency/Period In-Depth Setting

**Background** The input voltage/current range for frequency/period measurements can be set to Auto range or to manual. By default, the voltage/current range is set to Auto for both the period and frequency.

**Auto range** Press the Auto/Enter key. Auto  will be displayed on the upper right corner. 

**F2 (Gate Time) key to select gate time** **Background** It is the threshold to recalculate frequency/period. Slower the gate time, e.g., 1s, more accurate the reading value.

Press the F2 key to enter gate time menu. Click the F1 - F3 key for the desired gate time. See the figure below with available options.



**F4 (InJack) key to select voltage or current** **Background** In accordance with the target inputs, choose the corresponding selection per condition. E.g., select "3A" when the input current is below 3A amplitude.

Press the F4 (InJack) key to determine whether the voltage or current 3A or current 10A (RSDM-9061 only) to be measured. Press the F1 - F3 key to select desired option. See the figure shown below with options available.



**F5 (Time Out) key to select timeout** **Background** It defines the exact value for timeout, which means measurement will be suspended after reaching the set timeout value when none of input is detected.



Press the F5 key to enter timeout menu. Click the F1 – F2 key for the desired timeout setting. See the figure below with available options.

**TimeOut**



Note

When selecting “Auto”, the timeout setting will fully sync with the gate time value.

F1 (AC Range) key to manually select range setting

Press the “+” or the “-” key to promptly select the range. The Auto indicator **A** turns to **M** indicating Manual range selection. If the appropriate range is unknown, select the highest range.



You can also press the F1 (AC Range) key to select a range for the measurement. Depending on the InJack setting, the available options vary. See examples below.

**AC Range**

When InJack is Voltage:

Press the F1 ~ F6 key to select a desired range for the measurement.

AC Range						ESC:Return ↻
Auto	100mV	1V	10V	100V	750V	

When InJack is 3A:

**More 1/2**

Press the F1 ~ F5 key to select a desired range for the measurement.

AC Range						ESC:Return ↻
Auto	100uA	1mA	10mA	100mA	More 1/2	

Press the F6 (More 1/2) key for next page with more options as figure shown below.

AC Range						ESC:Return ↻
1A	3A				Page Up	



When InJack is 10A (RSDM-9061 only):



Press the F1 ~ F2 key to select a desired parameter for the measurement.

AC Range						ESC:Return ↻
Auto	10A					



# Capacitance Measurement

**Background** The capacitance measurement function checks the capacitance of a component.

**Activate capacitance test** Press the Shift →  to activate capacitance measurement.  + 

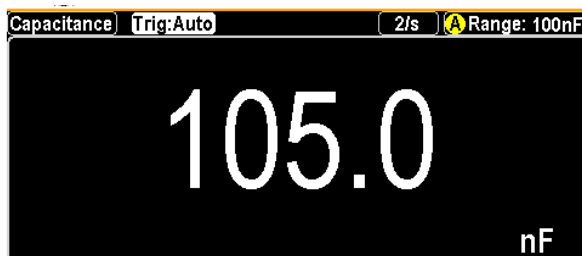
**Capacitance mode display appears** The screen will switch to capacitance mode immediately. Press  +  on the front panel as shown below.



Capacitance	Indicates the Capacitance measurement
2/s	Indicates the active refresh rate
 Note	Refresh rate of capacitance is fixed in 2/s.
	Indicates Automatic range selection
Range: 100nF	Indicates the available range of Capacitance
105.0 nF	Indicates the exact measured value

Connect the test lead and measure between the Input HI terminal and the LO terminal; Positive-HI, Negative-LO. The display updates the reading.

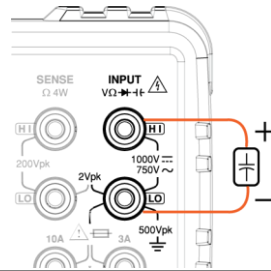

## Cable Open Function

**Background** Cable open function will be activated when capacitance range is between 1nF and 10nF. It is required to proceed to Cable Open function when capacitance is between 1nF and 10nF in which test leads connected will result in measuring capacity in small scale.

**Display**

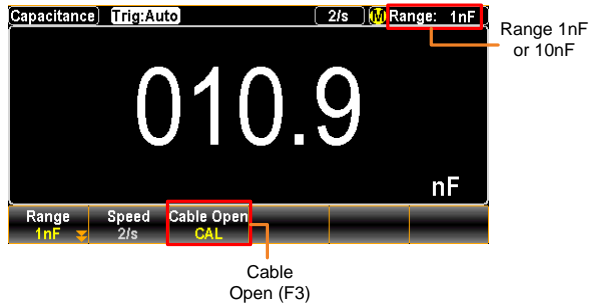

**Activate cable open function** Connect test leads followed by pressing the F3 (Cable Open) key to proceed to Cable Open function. The measured value will be rectified and returned to zero as the figure shown below.



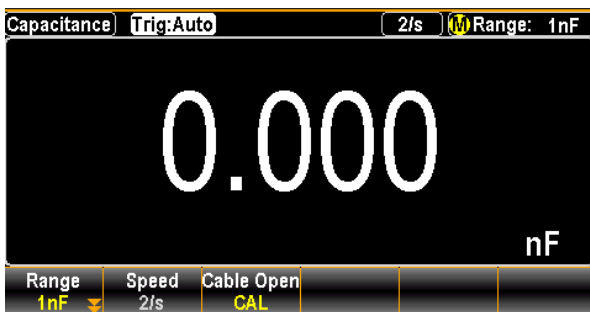

Connect the test lead and measure capacitance measurement to measure and obtain precise-prone value.



Note

Except for 1nF/10nF, all are Not applicable to Cable Open function.

## Select Capacitance Range

Auto range

To turn the automatic range selection On/Off, press the Auto key.



Manual range

Press the "+" or the "-" key to select the range. The Auto indicator **A** turns to **M** indicating Manual range selection. If the appropriate range is unknown, select the highest range.



You can also press the F1 (Range) key to select a range for the measurement.





Press the F1 ~ F5 key to select a desired range for the measurement.



Press the F6 (More 1/2) key for next page with more options as the figure shown below.



	Range			[ESC] Return ↩
	10uF	100uF		Page Up
Selectable Capacitance Ranges	Range	Resolution	Full scale	
	1nF	1pF	1.199nF	
	10nF	10pF	11.99nF	
	100nF	100pF	119.9nF	
	1μF	1nF	1.199μF	
	10μF	10nF	11.99μF	
	100μF	100nF	119.9μF	
 Note	For further details, please see the specifications on page 355.			
 Note	The refresh rate settings and the EXT trigger cannot be used in the capacitance mode.			

# Temperature Measurement

**Background** The RSDM-9060/9061 can measure temperature utilizing several devices including Thermocouple, RTD (Resistance Temperature Detector) as well as Thermistor. To measure temperature, the RSDM-9060/9061 accepts a device input and calculates the temperature from the voltage fluctuation.

<b>Temperature Range</b>	Thermocouple	-200°C ~ +1820°C (vary by sensor types)
	RTD	-200°C ~ +630°C
	Thermistor	-80°C ~ +150°C

**Activate temperature measurement** Press the TEMP key to activate temperature measurement.



**Temperature mode display appears**

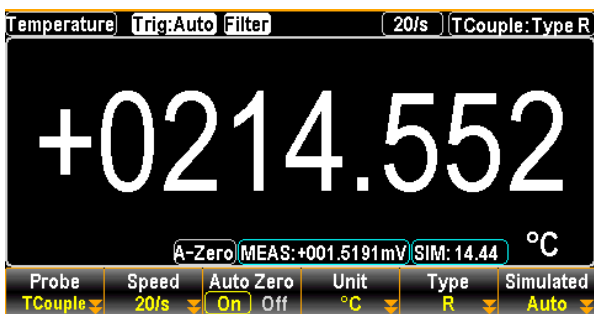

Temperature	Indicates Temperature measurement
+ 0214.552 °C	Indicates the exact measured value
T Couple	Indicates the active Probe
Type R	Indicates the active Type



Connect the test lead and measure between the Input HI terminal and the LO terminal. The display updates the reading.

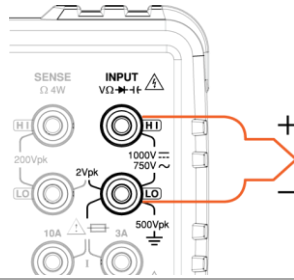

## General Temperature Setting

F2 (Speed) key to select the rate  
 Press the F1 ~ F3 key to select the desired rate



F3 (Auto Zero) key to enable Auto Zero

Background Autozero provides the most accurate measurements, but requires additional time to perform the zero measurement. With autozero enabled (On), the RSDM-9060/9061 internally measures the offset following each measurement. It then subtracts that measurement from the preceding reading. This prevents offset voltages present on the RSDM-9060/9061's input circuitry from affecting measurement accuracy. With autozero disabled (Off), the RSDM-9060/9061 measures the offset once and subtracts the offset from all





subsequent measurements.

**Display** When turning On the Auto Zero, the display shows an icon  indicating the Auto Zero mode is currently being activated.

**F4 (Unit) key to select unit of temperature** Press the F4 (Unit) key to enter the Temperature Unit menu followed by clicking the F1 - F3 key to choose desired temperature unit. See the figure shown below.



## Thermocouple Sensor Type

**Background** The RSDM-9060/9061 accepts thermocouple inputs and calculates the temperature from the voltage difference of two dissimilar metals. Thermocouple sensor type is one of the main factors to be considered.

Parameter	Thermocouple Sensor Type	Measurement Range	Resolution
	J	-210 to +1200°C	0.002 °C
	K	-200 to +1372°C	0.002 °C
	N	-200 to +1300°C	0.003 °C
	R	-50 to +1768°C	0.01 °C
	S	-50 to +1768°C	0.01 °C
	T	-200 to +400°C	0.002 °C
	B	+250 to +1820°C	0.01 °C
	E	-200 to +1000°C	0.002 °C

## Reference Junction Temperature (SIM Temperature)

---

**Background**  
(Thermocouple only)

When a thermocouple is connected to the RSDM-9060/9061, the temperature difference between the thermocouple lead and the RSDM-9060/9061 input terminal should be taken into account and be cancelled out; otherwise an erroneous temperature might be added. The value of the reference junction temperature should be determined by the user.

Type	Range	Resolution
SIM (simulated)	-20°C ~ +80°C	0.01°C

The terminal temperature is manually defined by user.

Default value: Auto

---

## Thermocouple Setting

---

**Procedure**

1. Press the F1 (Probe) key **Probe** to enter the Temperature Probe menu followed by clicking the F1 (TCouple) key **TCouple** to activate Thermocouple mode. See the figure shown below.



2. Press the F5 (Type) key **Type** to enter the Sensor Type menu as the figure shown below. Click the F1 - F5 key to select a desired sensor type per situations.



3. Press the F6 (More 1/2) key **More 1/2** to enter the next page with more sensor types available for selection.

---

Sensor Type				ESC:Return
T	B	E		Page Up

4. Further press the F6 (Simulated) key **Simulated** after returning to the previous menu page. You can select either the default fixed “23.00” or the “Auto” option for the so-called “Reference Junction Temperature” as following.

Simulated Method Setup		ESC:Return
23.00	Auto	

- When selecting “23.00” by F1 (23.00) key **23.00**, the display shows an icon **SIM: 23.00** indicating the simulated baseline is 23°C.
- If choosing “Auto” by F2 (Auto) key **Auto**, the subset menu appears with additional option. Press the F3 (ADJ:+00.00) key **ADJ:+00.00** followed by inputting a desired parameter as the following figure (+10 for example).

Auto SIM Offset	+10.00	3 6	ESC:Return
°C			Enter

5. Press the F6 (Enter) key **Enter** or the Knob key



to confirm the setting. The icon **SIM: 34.50** appears on display indicating the simulated 34.5 °C, which derives from the input terminal temperature plus the defined +10 degrees. That is, the input terminal temperature is  $34.5 - 10 = 24.5$  °C.

## RTD 2W/4W Setting

**Background** The RSDM-9060/9061 supports 2 or 4 wire RTD. It is important to specify the type of temperature sensor used.

Parameter	RTD type	Range	Resolution
	All (based on PT100)	-200~630°C	0.001°C

- Procedure**
1. Press the F1 (Probe) key **Probe** to enter the Temperature Probe menu followed by clicking either the F2 (RTD 2W) **RTD 2W** or F3 (RTD 4W) key **RTD 4W** to activate RTD 2W/4W mode. See the figure shown below.



2. Press the F5 (Type) key **Type** to enter the Sensor Type menu as the figure shown below. Click the F1 - F5 key to select a desired sensor type per your requirement.



3. The display shows the latest setting. See the example of the figure below where RTD 2W: PT100 is currently activated by user.

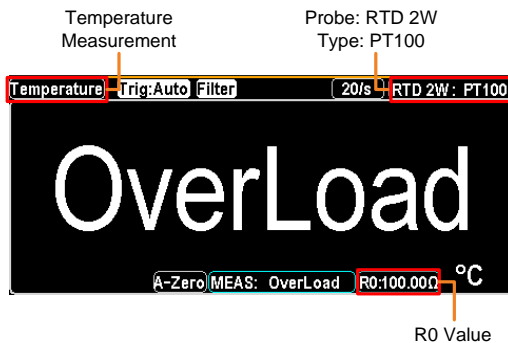

## Set User Type of RTD 2W/4W

**Background** The User Type allows any customized RTD sensor coefficients to be used. The User Type is available for user to configure the alpha, beta, delta and R0 coefficients individually, as defined by the Callendar-Van Dusen equation.

Type	Alpha ( $\alpha$ )	Beta ( $\beta$ )	Delta ( $\delta$ )
PT100	0.00385	0.10863	1.49990
D100	0.00392	0.10630	1.49710
F100	0.00390	0.11000	1.49589
PT385	0.00385	0.11100	1.50700
PT3916	0.00392	0.11600	1.50594

**Equation**

**-200°C to 0°C**  $R_{RTD} = R_0[1+AT+BT^2+CT^3 (T-100)]$   
**range** where:  $R_{RTD}$  is the calculated resistance of the RTD  
 $R_0$  is the known RTD resistance at 0°C  
 $T$  is the temperature in °C

$A = \alpha [1 + (\delta/100)]$   
 $B = -1 (\alpha)(\delta)(1e-4)$   
 $C = -1 (\alpha)(\beta)(1e-8)$

---

**-0°C to 630°C**  $R_{RTD} = R_0 (1+AT+BT^2)$   
**range** where:  $R_{RTD}$  is the calculated resistance of the RTD  
 $R_0$  is the known RTD resistance at 0°C  
 $T$  is the temperature in °C

$A = \alpha [1 + (\delta/100)]$   
 $B = -1 (\alpha)(\delta)(1e-4)$

**Operate Procedure**

1. Press the F5 (Type) key **Type** to enter the Sensor Type menu followed by pressing the F6 (User) key **User** to activate User Type.

Sensor Type					[ESC]:Return
PT100	D100	F100	PT385	PT3916	User

- Press the F6 (User Type) key **User Type** to enter the User Type Setup menu where  $\alpha$ ,  $\beta$ ,  $\delta$  and R0 coefficients can be set up respectively.



- Click the F1 ( $\alpha$ :0.003850) key  **$\alpha$ :0.003850** to enter the RTD Alpha Setup page as the figure shown below. Use the Left/Right arrow keys to move cursor and scroll the Knob key or press Number keys to enter the desired value.  
 $\alpha$  default: 0.00385  
 $\alpha$  range: 0 ~ 9.999999



- Press the F6 (Enter) key **Enter** or the Knob key to confirm the input  $\alpha$  value and repeat the previous steps 2 - 4 to set up the  $\beta$  (Beta),  $\delta$  (Delta) and R0 coefficients individually.  
 $\beta$  default: 00.10863,  $\delta$  default: 1.49990, R0 default: 100  
 $\beta$ ,  $\delta$  range: 0 ~ 9.999999, R0 range: 80 ~ 120

#### RTD Beta Setup



#### RTD Delta Setup



#### RTD R0 Setup



- After returning to the User Type Setup page, if necessary, press the F6 (PT100 DEF) key **PT100 DEF** to restore to the default coefficients' setting based on the PT100 sensor type.

## Thermistor 2W/4W Setting

**Background** The RSDM-9060/9061 supports 2 or 4 wire Thermistor. It is important to specify the type of temperature sensor used.

Parameter	Type	Range	Resolution
	All	-80~150°C	0.001°C

- Procedure**
1. Press the F1 (Probe) key to **Probe** enter the Temperature Probe menu followed by clicking either the F4 (Therm2W) **Therm2W** or F5 (Therm4W) key **Therm4W** to activate Therm 2W/4W mode. See the figure shown below.



2. Press the F5 (Type) key **Type** to enter the Sensor Type menu as the figure shown below. Click the F1 – F3 key to select a desired sensor type per your requirement.



3. The display shows the latest setting. See the example of the figure below where Thermistor 2W: 10kΩ is currently activated by user.

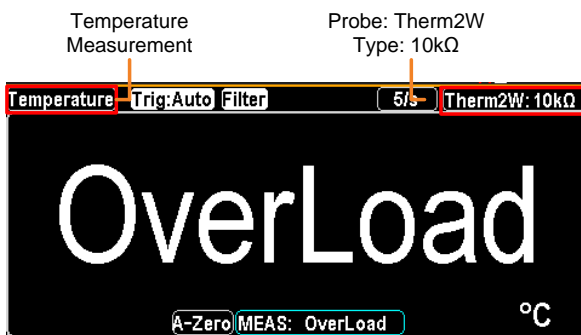

## Set User Type of Thermistor 2W/4W

**Background** The User Type allows any customized Thermistor sensor coefficients to be used. The User Type is available for user to configure the A, B and C coefficients individually as defined by the Steinhart–Hart equation.

Type / Coefficient	A	B	C
2.2k	0.0014733	0.0002372	1.07E-07
5k	0.0012880	0.0002356	9.56E-08
10k	0.0010295	0.0002391	1.57E-07

**Equation**

$$T_K = \frac{1}{A + B(\ln R) + C(\ln R)^3}$$

where:  $T_K$  is the calculated temperature in Kelvin.

$\ln R$  is the natural log of the measured resistance of the themistor.

A, B, and C are the curve fitting constants.

**Operate Procedure**

- Press the F5 (Type) key **Type** to enter the Sensor Type menu followed by pressing the F4 (User) key **User** to activate User Type.





- Press the F6 (User Type) key **User Type** to enter the User Type Setup menu where A, B and C coefficients can be set up respectively.



- Click the F1 (A:1.2880E-03) key **A:1.2880E-03** to enter the THERM A Setup page as the figure shown below. Use the Left/Right arrow keys to move cursor and scroll the Knob key or press Number keys to enter the desired value.

A range: 0 ~ 9.9999 (default: 1.2880E-03)



- Press the F6 (Enter) key **Enter** or the Knob

key  to confirm the input A value and repeat the previous steps 2 - 4 to set up the B and C coefficients individually.

B range: 0 ~ 9.9999 (default :2.35600E-04)

C range: 0 ~ 9.9999 (default :9.55700E-08)

### THERM B Setup



### THERM C Setup



- After returning to the User Type Setup page, if necessary, press the F6 (5 kΩ DEF) key **5kΩ DEF** to restore to the default coefficients' setting based on the 5 kΩ sensor type.

# DUAL MEASUREMENT

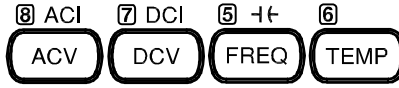

---

Dual Measurement.....	79
Refresh Rate.....	82
Connect the Test Leads .....	83
The error influence on Dual Measurement (V & I) .....	85
The error of current shunt .....	87

# Dual Measurement

## Background

The dual measurement mode allows you to use the 2nd display to show another item, thus viewing two different measurement results at once.

When the multimeter is used in dual measurement mode, both displays are updated from either a single measurement or from two separate measurements. If the primary and secondary measurement modes have the same range, rate and rely on the same fundamental measurement, then a single measurement is taken for both displays; such as ACV and frequency/period measurements. If the primary and secondary displays use different measurement functions, ranges or rates, then separate measurements will be taken for each display. For example, ACV and DCV measurements.

Most of the basic measurement functions, except for resistance/continuity/diode/capacitance can be used in the dual measurement mode. The following table shows the available measurement combinations.

Primary Display	Secondary Display					
	ACV	DCV	ACI	DCI	FREQ	Temp
ACV	X	•	•	•	•	X
DCV	•	X	•	•	X	•
ACI	•	•	X	•	•	X
DCI	•	•	•	X	X	•
FREQ	•	X	•	X	X	X

## Note

When two different measurements are taken, there is a switching delay between the first measurement and the second measurement.

1st Measurement item setting Choose one of the basic measurement functions from the table above to set the measurement mode for the primary display.



For example, press DCV to set the first display to DCV measurement.

2nd Measurement item setting To set a measurement mode for the second display, press the F6 (2ND) key and the 2ND Function options appear subsequently.



For example, press the F2 (ACV) key to select ACV measurement for the second display.

Display



1ST Display Shows the DCV measurement

2ND Display Shows the ACV measurement



in orange

Indicates that 1ST display is the currently active display.

**Editing 1st or 2nd measurement item settings** After the secondary measurement function has been activated, the rate, range and measurement item can be edited for either the primary or secondary display. Note, however, it is more practical to configure the first or second measurement items before activating dual measurement mode.

To edit measurement parameters in dual measurement mode, you must first set which display is the active display. The orange outline covering either 1ST or 2ND icon indicates the active display.

**1. Select active display**

Toggle the active display between the 1ST and 2ND display by pressing the Knob key:

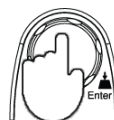

Primary display: 1ST highlighted in orange outline.

Secondary display: 2ND highlighted in orange outline.

**Display**

1ST in active display: 

2ND in active display: 

**2. Edit active display settings**

Edit the range, rate or measurement item for the active display in the same way as for single measurement operation.

**Turn Off 2nd Measurement**

To turn Off the 2ND measurement, first toggle in 1ST active display followed by pressing the F6 (2ND) key. Click the F6 (OFF) key again to disable the 2ND measurement.



## Refresh Rate

**Background** Refresh rate defines how frequently the RSDM-9060/9061 captures and updates measurement data. A faster refresh rate yields a lower accuracy and resolution. A slower refresh rate yields a higher accuracy and resolution. Consider these tradeoffs when selecting the refresh rate.

Measurement Type	Refresh Rate
DCV/DCI	5/s, 20/s, 60/s, 100/s, 400/s, 1k/s <sup>*1</sup> , 1.2k/s <sup>*2</sup> , 2.4k/s <sup>*2</sup> , 4.8k/s <sup>*2</sup> , 7.2k/s <sup>*2</sup>
ACV/ACI	1/s, 5/s, 20/s
Frequency /Period	1s, 100ms, 10ms

 **Note** <sup>\*1</sup> is applicable to RSDM-9060, whilst <sup>\*2</sup> is specifically for RSDM-9061.

### Selection steps

1. Toggle the active display between the 1ST and 2ND display by pressing the Knob key until click.

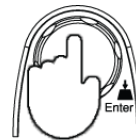

2. Press the F2 (Speed) key to select a desired rate for measurement. Press the corresponding function key (F1 - F5) in accord with the desired option on screen display. Also, press the F6 (More 1/2) key to enter the next page with more options when available.



- The refresh rate will be shown at the left side of each display. See the figure below shown.

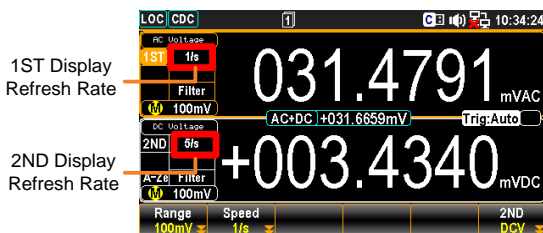

Reading Indicator The reading indicator  flashes according to the defined refresh rate setting of the active display.

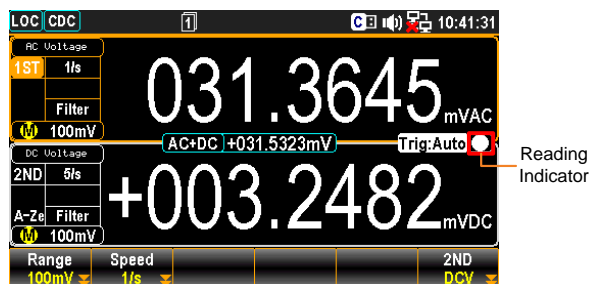

## Connect the Test Leads

Connect the test leads and measure When using the dual measurement function, the connection method and number of test leads required depends on the measurement combination. Use the connect diagrams below as guide when taking dual measurements.

## Voltage and Frequency/Period Measurement

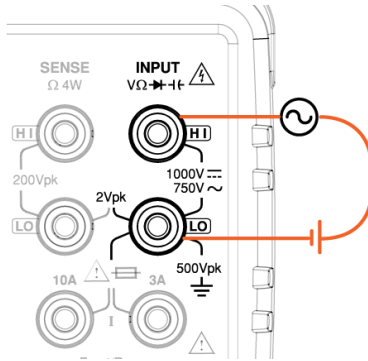

## Voltage/Frequency/Period and Current Measurement

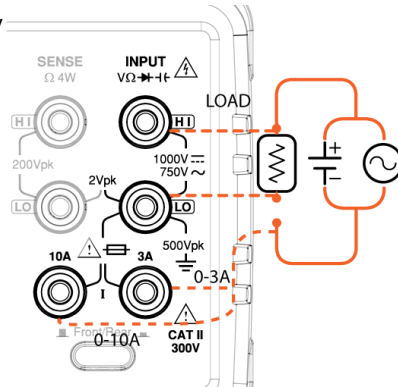

### Note

DC Current measurements will be displayed as a negative value as the polarity of the current leads has been reversed.

Please take into account the resistance of the test leads and internal resistance of the current connection as it is in series with the test circuit.

The above measuring configuration is used to measure the voltage present on the resistance under test and the current through the resistance under test when using the DCI/DCV or ACI/ACV dual measurement function.

When dual measurement (DCI/DCV or ACI/ACV) is underway, the input impedance will change, thus resulting in load deviation due to the fluctuation of different measuring range.





Diagram

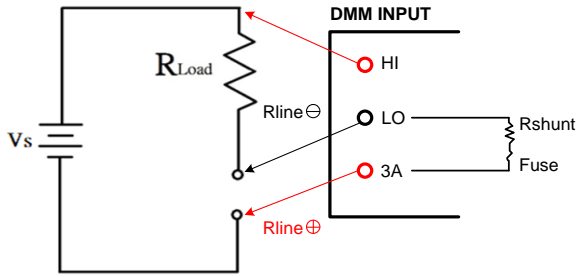

Example

$V_s$  = Voltage source

$R_{Load}$  = Load under test

$R_{int}$  = Current terminal total impedance containing  $R_{shunt}$  + Fuse +  $R_{line}^{\oplus}$  +  $R_{line}^{\ominus}$

When different current range for measurement is selected,  $R_{shunt}$  will vary accordingly.

For example,

$V_s = 10V$ ,  $R_{load} = 10 \Omega$ ,  $V_s = 10V$ ,  $R_{load} = 10 \Omega$

If the total impedance passing through current terminal is  $R_{int} = 0.5\Omega$ , the ideal measured voltage will be 10V regardless of impact on load from voltmeter input impedance. The calculation for

actual measured value is  $10V * \frac{10 \Omega}{(10 \Omega + 0.5 \Omega)} = 9.52381V$ .

Error (%) =  $\frac{R_{int}}{(R_{load} + R_{int})} * 100$ , this error is applicable to not only DC but AC measurement as well. The influence will be probably more serious depending on varied actual conditions.

## The error of current shunt

### Background

The principle of current measuring is to obtain current via the voltage proportionated by the measured shunt resistor and the current under test. The circuit is basically designed by high impedance ( $0.01\Omega\sim 100\Omega$  approximately) and with shortcoming of voltage drop by shunt. There will be obvious error occurred while measuring low current due to the measurable voltage generated by a larger shunt.

An ideal ammeter never changes flowing route of current, and thus it owns the characteristics of both zero-input resistor and zero-input voltage drop. In practice, however, ammeter always generates an input voltage drop while measuring, which is known as burden voltage in series.

### Diagram

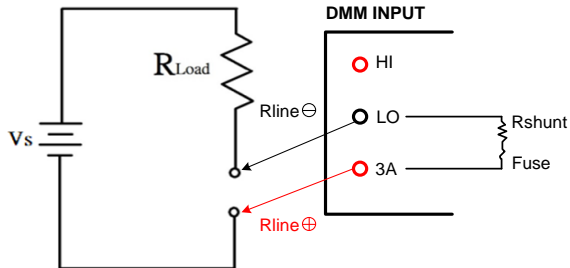

Example

$V_s$  = Voltage source

$R_{Load}$  = Load under test

$R_{int}$  = Current terminal total impedance containing  $R_{shunt}$  + Fuse +  $R_{line}^{\oplus}$  +  $R_{line}^{\ominus}$

When different current range for measurement is selected,  $R_{shunt}$  will vary accordingly.

For example,

$V_s = 10V$ ,  $R_{Load} = 10 \Omega$ ,  $R_{int}$  = total impedance flowing through current terminal  $0.5\Omega$

The theoretical value for current reading should be

$$I = \frac{V_s}{R_{Load}} = 1A$$
 in that the DMM internal resistor  $R_{int}$ , which contains  $R_{shunt}$ ,  $R_{line}^{\oplus}$ ,  $R_{line}^{\ominus}$  and Fuse, will cause impact on the measuring reading.

The measured value is 
$$I = \frac{V_s}{(R_{Load} + R_{int})}$$

$$= \frac{10V}{(10\Omega + 0.5\Omega)} = 0.952381 \text{ A.}$$

$$\text{Error (\%)} = \frac{R_{int}}{(R_{Load} + R_{int})} * 100$$

This error is applicable to not only DC but AC measurement, and the burden voltage, per varied current measuring range, is generally within the range of several hundreds mV.

	Range	Shunt	Burden Voltage
	100 $\mu$ A	100 $\Omega$	<0.011 V
DC Current	1 mA	100 $\Omega$	<0.11 V
	10 mA	1 $\Omega$	<0.04 V
	100 mA	1 $\Omega$	<0.4 V

1 A	0.1 $\Omega$	<0.7 V
3 A	0.1 $\Omega$	<2 V
10 A	10m $\Omega$	<0.5 V

The above table indicates the maximum burden voltage caused by the maximum current within the applicable range.

# ADVANCED MEASUREMENT





---

Advanced Measurement Overview .....	91
Relative Value Measurement .....	92
Hold Measurement .....	94
Trigger Setting .....	98
Automatic/Single Triggering .....	98
Use External Trigger .....	99
Set Trigger Delay .....	101
Filter Setting .....	104
Digital Filter Overview .....	104
Digital Filter Setting .....	106
Math Measurement .....	109
dBm/dB/Watt Measurement .....	109
Compare Mode .....	119
MX+B Measurement .....	126
1/X Measurement .....	130
Measure Percent .....	133

## Advanced Measurement Overview

**Background**      Advanced measurement mainly refers to the type of measurement which uses the result obtained by one of the basic measurements: ACV, DCV, ACI, DCI, 2/4W, Diode/Continuity, Frequency/Period, and Temperature.

Advanced Measurement	Basic Measurement						
	AC/DCV	AC/DCI	2/4W	Hz/P	TEMP		
Relative	●	●	●	●	●	—	—
Hold	●	●	●	●	●	—	—
Trigger	●	●	●	●	●	●	—
Filter	●	●	●	●	●	—	—
dB	●	—	—	—	—	—	—
dBm	●	—	—	—	—	—	—
Compare	●	●	●	●	●	—	—
MX+B	●	●	●	●	●	—	—
1/X	●	●	●	●	●	—	—
Percent	●	●	●	●	●	—	—

# Relative Value Measurement

Applicable to



Background

Relative measurement stores a value, typically the data at the moment, as the reference. The following measurement is shown as the delta between the references. The reference value will be cleared upon exit.

REL, basically, is to subtract a certain value in the following measurement. The value is fixed and remains its effect even user exits and returns back to this function again.

One of the most seen purposes of REL is to eliminate impedance of test lead from measurement. Before operating impedance measurement, short circuit the test lead followed by pressing the [REL] button. For other measurements, press the [REL] button after putting test lead in a null circuit.

Alternatively, user can modify the value by pressing the [REL#] button followed by using the knob or number keys to enter a specified value. Press the [REL] button again to disable null operation.

Activate Relative measurement

Press the REL key. The measurement reading at the moment becomes the reference value.



Relative measurement display appears

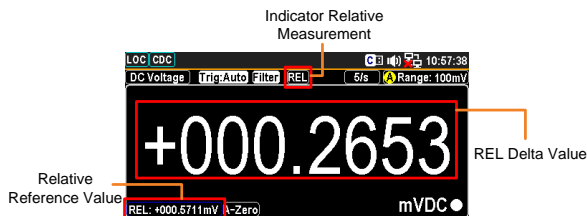



REL	Indicates Relative value measurement
REL: +000.5711mV	Shows the stored reference value
+000.2653	Shows the delta between the current measurement data and the reference value

Manually set the reference value

To set the reference (REL) value manually, press the Shift key followed by the REL key.

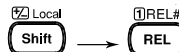

The setting appears.



First use function keys to decide unit value. Then use the Left/Right arrow keys to move cursor and scroll the Knob key or press Number keys to enter the desired value.



Press the F6 (Enter) key or the Knob key until click to confirm the relative value setting.



Deactivate Relative measurement

To cancel the Relative measurement, press the REL key again, or simply activate another measurement.



# Hold Measurement

Applicable to



Background

The Hold Measurement function retains the current measurement data and updates it only when it exceeds the set threshold (as a percentage of the retained value).

Activate Hold measurement

Press the Hold key to activate Hold measurement.



Hold measurement display appears

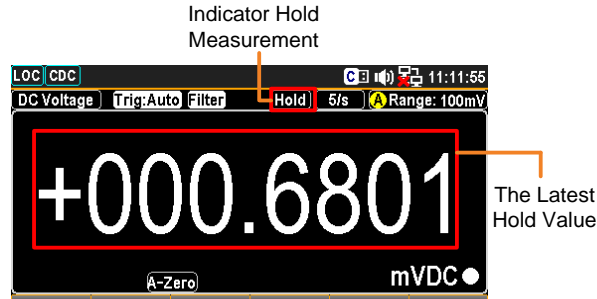

Hold Indicates Hold measurement

+000.6801 mVDC Shows the latest hold value

Enter hold settings

Press the Shift + Hold key to activate detailed setting menu of Hold mode as the figure below.

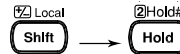

F5 (Percent) key to define threshold

Press the F5 (Percent) key to show the setting menu of Hold Percent as the figure below.



Hold Percent				[ESC]:Return
0.01%	0.1%	1%	10%	

Press F1 ~ F4 key to select desired hold percent. For example, once the measured value is beyond 10%, which corresponds to the selected 10% option here, the latest hold value will be updated on the main reading.

F4 (BeepVol) key to define beep volume

Press the F4 (BeepVol) key to show the menu of Volume level of Beep as the following.

**BeepVol**

Beep Volume				[ESC]:Return
Off	Small	Medium	Large	

Press the F2 - F4 key to select volume level. Once the latest hold value is updated, the beep sounds based on the defined volume. Press the F1 key to set Beep volume off.

F2 (MathDisp) key to show STAT & Math

Press the F2 (MathDisp) key to show the option menu as the figure below shown.

**MathDisp**

Proceed to the F2 (STAT) or F3 (Math) display in accord with the following chapters.

Math Display				[ESC]:Return
Off	STAT	Math		

Show STAT result

**Background** The STAT page in MathDisp allows you to make statistical calculations for several measurements including Minimum, Maximum, Average Peak-Peak, Standard Deviation and Count.

Operation Press the F2 (STAT) key **STAT** to show the statistical data immediately as the figure below.

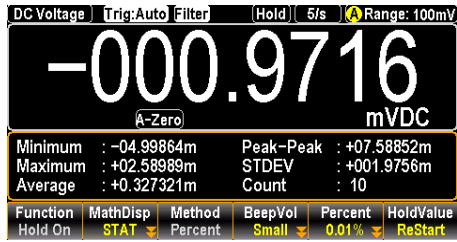

View Data -000.9716 mVDC Indicates the latest hold value

Minimum Indicates the minimum data value

Maximum Indicates the maximum data value

Average Indicates the mean (average) value

Peak-Peak Indicates the peak to peak data

STDEV Indicates the standard deviation of the data

Count Indicates the latest counts of hold

Show Math result Background The Math page in MathDisp allows you to view mathematical calculations for several parameters.

Operation Press the F3 (Math) key **Math** to show the mathematical analysis instantly as below.

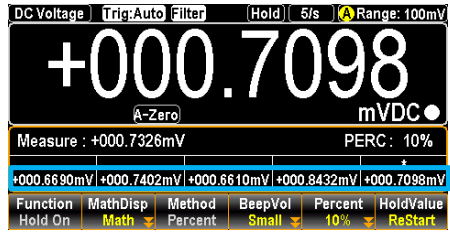

View Data +000.7098 mVDC Indicates the latest hold value

Measure: +000.7326mV Indicates the originally measured mV value

5 hold values in blue Indicates the latest 5 counts of hold values

F6 (HoldValue) key to restart

Press the F6 (HoldValue) key to simply Restart the hold value.

**HoldValue**

Function	MathDisp	Method	BeepVol	Percent	HoldValue
Hold On	Off	Percent	Small	0.1%	ReStart

# Trigger Setting

## Automatic/Single Triggering

Applicable to

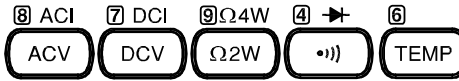

Automatic triggering (default)

By default, the RSDM-9060/9061 triggers according to the refresh rate automatically. See the previous page for refresh rate setting details. The figure below shows the screen of Automatic Trigger measurement.

Auto Trigger Mode

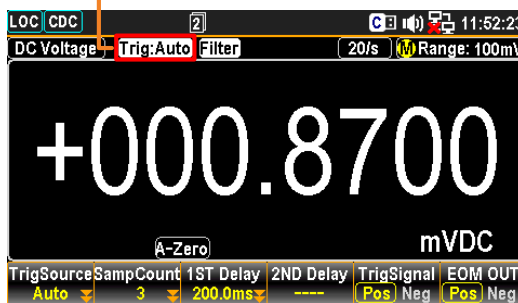

Single triggering

Press the TRIG key to Single trigger measurement. See below for details.



Single Trigger Mode

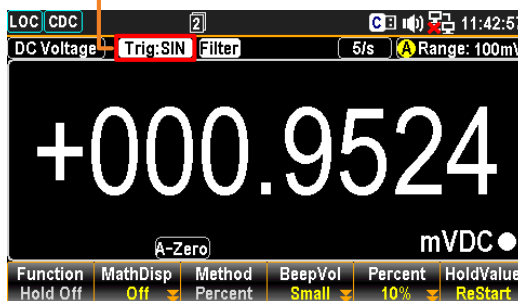

- Change mode
- Under Single Trigger mode, press and hold the TRIG button for at least 2 second to return to Auto Trigger mode.
  - Under Auto Trigger mode, simply press the TRIG button to return to Single Trigger mode.



## Use External Trigger

**Background** The RSDM-9060/9061 uses the internal trigger by default, for example to count the frequency and the period. Using an external trigger allows customized triggering conditions.

**Signal connection** Connect the external trigger signal to the Digital I/O port located on the rear panel.

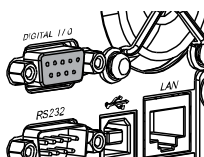

DB-9, female

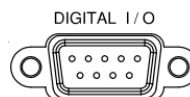

**Digital I/O pin assignment**

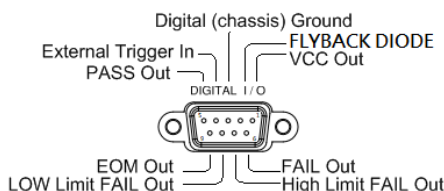

**Activate external trigger**

Press the Shift + TRIG key to activate setting menu of trigger.



TrigSource	SampCount	1ST Delay	2ND Delay	TrigSignal	EOM OUT
Auto	3	200.0ms	----	Pos Neg	Pos Neg

Press the F1 (TrigSource) key to enter the trigger source menu followed by pressing the F3 (EXT) to select External Trigger mode.



TrigSource				(ESC):Return
Auto	Single	EXT		

The “EXT” indicator appears on the display.

External Trigger Mode

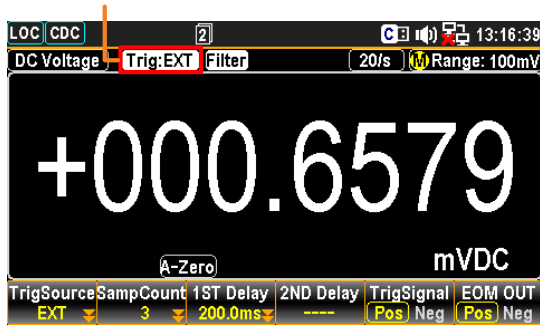

- Set sample count
- Under the setting menu of trigger, press the F2 (SampCount) key to enter the ensuing setting of Sample Count. Use the Left/Right arrow keys to move cursor and scroll the Knob key or press Number keys to enter the desired counts.



- Push the Knob key (Enter) or press **Enter** or the F6 (Enter) key to confirm the input value.  
Range: 1 ~ 1,000,000

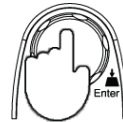

Set Trigger Signal Background When utilizing external trigger, select either positive or negative terminal as the main trigger source in light of the actual applications.

Press the F5 (TrigSignal) key to toggle between Positive and Negative mode for Trigger Signal.

**TrigSignal**





**Set EOM OUT**      **Background**      It indicates EOM (End Of Measurement) output signal. Select Positive or Negative as the output signal for extension applications when necessary.

Press the F6 (EOM OUT) key to toggle **EOM OUT** between Positive and Negative mode for EOM OUT setting.



**Reading indicator**      The reading indicator  does not flash before triggering (can be on or off). After triggering, the indicator flashes according to the external signal trigger timing.

**Exit external trigger**      Press the F1 (TrigSource) key to reenter the TrigSource menu followed by pressing the F1 (Auto) or the F2 (Single) key to switch to other trigger modes.

**TrigSource**

Auto

Single



Alternatively, it is viable to simply click the TRIG button to change to Trig:SIN mode or click and hold the TRIG button for 2 seconds to enter the Trig:Auto mode.



## Set Trigger Delay

**Background**      Trigger delay defines the time delay between triggering and measurement start. The default is set at 200us.

**Manual trigger delay**      1. Press the Shift + TRIG key to activate setting menu of trigger.

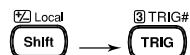

- Press the F3 (1ST Delay) key to enter the Trigger Delay (1ST) menu. The Trigger Delay setting appears as the figure below.

**1ST Delay**



Note

The F4 (2ND Delay) key is only available when 2ND measurement is activated.

- Press the F4 (AutoDelay) key to switch to the manual delay time setting.

**AutoDelay**



- Use F1 – F3 keys to decide unit value. Then use the Left/Right arrow keys to move cursor and scroll the Knob key or press Number keys to enter the desired value.

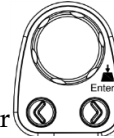

- Push the Knob key (Enter) or press the F6 (Enter) key to confirm the input value.  
Range: 0 ~ 3600s, 1us resolution

**Enter** or

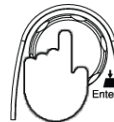

- Auto trigger delay
- Repeat the steps 1 – 2 of manual trigger delay first, and press the F4 (AutoDelay) key to switch the display as the following.

**AutoDelay**



- 
2. Press the ESC key to return to the previous page and have the auto trigger delay setting take effect. The 1ST display will be shown like the following figure.

A screenshot of a menu titled '1ST Delay' with 'Auto' selected and a dropdown arrow.

1ST Delay  
Auto ▾

# Filter Setting

## Digital Filter Overview

---

Applicable to



Filter basics

The RSDM-9060/9061 internal digital filter converts the analog input signal into digital format before passing it to internal circuits for processing. The filter affects the amount of noise included in the measurement result.

Filter type

The digital filter averages a specific number of input signal samples to generate one reading. The filter type defines the averaging method. The following diagrams highlight the differences between the Moving and Repeating filter using 4 samples per reading.

Moving  
(default)

The Moving filter takes in one new sample and discards the oldest sample per reading. This is the default behavior when the digital filter is not specified, and is recommended for most applications.

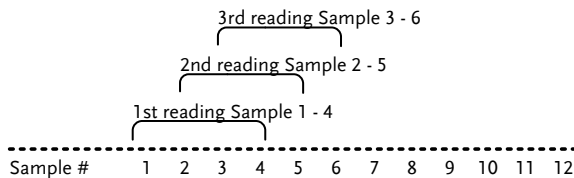

Repeating

The Repeating filter renews a whole group of samples per reading. This method is recommended when using the optional scanner.



Filter window Formula

Measure:  
 $\text{Previous Meas} * (1 - \text{window}) < \text{threshold} < \text{Previous Meas} * (1 + \text{window})$ .

Range:  
 $\text{Previous Measure} + (\text{Range} * \text{window}) < \text{threshold} < \text{Previous Measure} + (\text{Range} * \text{window})$

There are 5 windows range settings that can be chosen: 10%, 1%, 0.1%, 0.01% and none

## Digital Filter Setting

Filter setting

Press the Shift key + Menu (Filter) key. The Filter setting menu shows as the figure below.

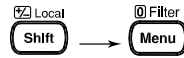

Select display

Press the F1 (Setup) key to toggle between the 1ST and the 2ND measurement to be setup for filter setting.

Only when 2ND measurement is enabled, you are able to toggle options here. Otherwise, only the 1ST is available for setup



Turn on filter

Press the F2 (Filter) key to turn On or Off filter function. The Filter indicator appears on the display.



## Indicator Filter On

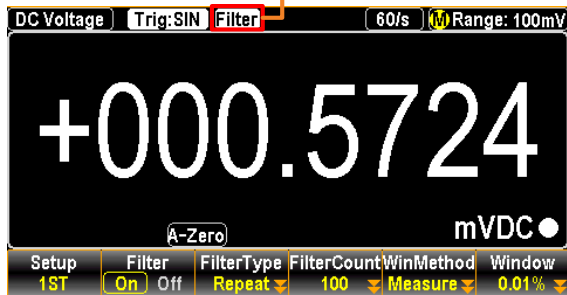

Choose filter type Press the F3 (FilterType) key to enter the subsequent menu. Press the F1 or F2 keys to select desired filter type.



Define filter count Press the F4 (FilterCount) key to enter the subsequent menu. Use the Left/Right arrow keys to move cursor and scroll Knob key or press Number keys to enter the desired value.

**FilterCount**



Press the F6 (Enter) key or the Knob key until click to confirm the filter count settings.

**Enter** or

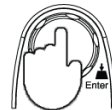

Range: 2 ~100



Set filter window method Select the Filter Window Method by clicking the F5 (WinMethod) key. The display changes accordingly as the figure below shown. Press the F1 or F2 keys to choose desired Filter Window Method.

**WinMethod**



Define filter window

Press the F6 (Window) key to enter the subsequent menu. Press the F1 - F5 keys to choose desired Filter Window percentage.



Range 0.01%, 0.1%, 1%, 10%, None

Turn off Filter

Press the Shift key + the Menu (Filter) key. Press the F2 (Filter) key to turn Off Filter function.

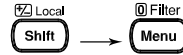

The Filter indicator will disappear from display.





# Math Measurement

---

Applicable to	<div style="display: flex; justify-content: space-around; align-items: center;"> <div style="border: 2px solid black; border-radius: 15px; padding: 5px; margin: 2px;">8 ACV</div> <div style="border: 2px solid black; border-radius: 15px; padding: 5px; margin: 2px;">7 DCI</div> <div style="border: 2px solid black; border-radius: 15px; padding: 5px; margin: 2px;">9 Ω4W</div> <div style="border: 2px solid black; border-radius: 15px; padding: 5px; margin: 2px;">FREQ</div> <div style="border: 2px solid black; border-radius: 15px; padding: 5px; margin: 2px;">6 TEMP</div> </div>
Background	Math measurement runs 6 types of mathematical operations, dBm, dB, Compare, MX+B, 1/X and Percent, based on the other measurement results.
Math Equation	dBm $10 \times \log_{10} (1000 \times V_{\text{reading}}^2 / R_{\text{ref}})$
	dB $\text{dBm} - \text{dBm}_{\text{ref}}$
	Compare Checks and updates if measurement data stays between the specified upper (high) and lower (low) limit.
	MX+B Multiplies the reading (X) by the factor (M) and adds/subtracts offset (B).
	1/X Divides 1 by the reading (X).
	Percentage Runs the following equation. $\frac{(\text{Reading}X - \text{Reference})}{\text{Reference}} \times 100\%$

## dBm/dB/Watt Measurement

---

Applicable to	<div style="display: flex; justify-content: space-around; align-items: center;"> <div style="border: 2px solid black; border-radius: 15px; padding: 5px; margin: 2px;">ACV</div> <div style="border: 2px solid black; border-radius: 15px; padding: 5px; margin: 2px;">DCV</div> </div>
Background	Using the ACV or DCV measurement result, the RSDM-9060/9061 calculates the dBm, dB or Watt value based on a reference resistance value in the following way.
Equation	dBm $10 \times \log_{10} (1000 \times V_{\text{reading}}^2 / R_{\text{ref}})$
	dB $\text{dBm} - \text{dBm}_{\text{ref}}$
	Watt $V_{\text{reading}}^2 / R_{\text{ref}}$



Parameters	Vreading	Input Voltage, ACV or DCV
	Rref	Reference resistance simulating an output load
	dBmref	Reference dBm value

### Measure dBm/Watt

Applicable to



Equation	dBm	$10 \times \log_{10} (1000 \times V_{\text{reading}}^2 / R_{\text{ref}})$
	Watt	$V_{\text{reading}}^2 / R_{\text{ref}}$
Parameters	Vreading	Input Voltage, ACV or DCV
	Rref (REF Ω)	Reference resistance simulating an output load

Activate dBm

Press the Shift key + Math key to activate Math setting menu as the following figure shown.

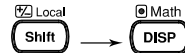

Further press the F1 (Function) key to enter the Math Function menu as the figure shown below.



Press F3 (dBm) key to enable the dBm function. The screen, after activation, will appear as figure below.



Indicator dBm On

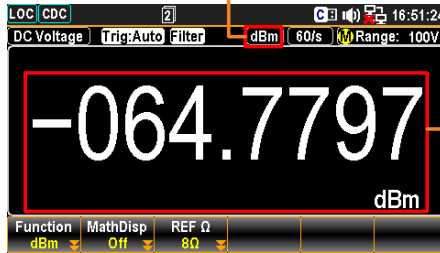

Measured dBm Value

Select reference resistance (REF  $\Omega$ ) To change the reference resistance, press the F3 (REF  $\Omega$ ) key to enter the setting menu. Scroll the Knob key or press Number keys to enter the desired value of reference resistance.

**REF  $\Omega$**



Push the Knob key (Enter) or press the F6 (Enter) key to confirm the input reference resistance.

**Enter** or

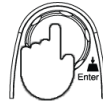

Resistance List 2, 4, 8, 16, 50, 75, 93, 110, 124, 125, 135, 150, 250, 300, 500, 600, 800, 900, 1000, 1200, 8000

View result in Watt When the reference resistance is less than 50 $\Omega$ , it is possible to calculate the watt value. If the reference resistance is greater than 50 $\Omega$ , please ignore this step.

To calculate the Watt power, press the **Function** F1 (Function) key followed by clicking the F3 (dBm) key again. **dBm**

Watt result appears



F2 (MathDisp) key Press the F2 (MathDisp) key to show the Math Display menu as the figure below shown. Proceed to the F2 (STAT) or F3 (Math) display in accord with the following chapters.



Show STAT result Background The STAT page in MathDisp allows you to make statistical calculations for several measurements including Minimum, Maximum, Average Peak-Peak, Standard Deviation and Count.

Operation Press the F2 (STAT) key to show the statistical data immediately as the figure below.

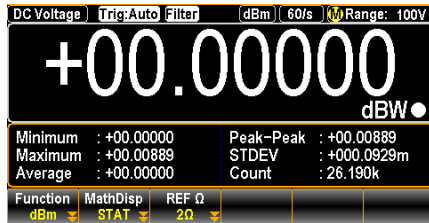

View Data +00.00000 dBW Indicates the latest dBW value

Minimum Indicates the minimum data value

Maximum Indicates the maximum data value

---

Average Indicates the mean (average) value

---

Peak-Peak Indicates the peak to peak data

---

STDEV Indicates the standard deviation of the data

---

Count Indicates the latest counts of dBm

---

Show Math result Background The Math page in MathDisp allows you to view mathematical calculations for several parameters.

---

Operation Press the F3 (Math) key  to show the mathematical analysis instantly as below.

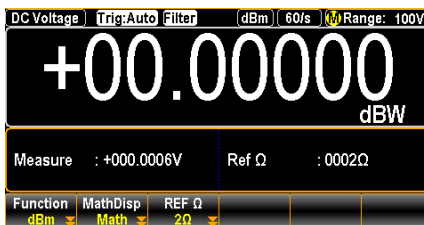

View Data +00.00000 dBW Indicates the latest dBW value

---

Measure: +000.0006V Indicates the originally measured Voltage value

Ref  $\Omega$  Indicates the defined reference  $\Omega$  value.

---

Deactivate dBm/dBW measurement To cancel the dBm/dBW measurement, press the F1 (Function) key followed by clicking F1 (OFF) key to deactivate or simply activate another measurement.





Measure dB



Applicable to



Equation	dB	$\text{dBm} - \text{dBmref}$
	$\text{dBm}$	$10 \times \log_{10} (1000 \times V_{\text{reading}}^2 / R_{\text{ref}})$
Parameters	dBmref	Reference dBm value
Background	dB is, specifically, defined as [dBm-dBmref]. When the dB measurement is activated, the RSDM-9060/9061 calculates the dBm using the reading at the first moment and stores it as dBmref.	

Activate dB Press the Shift + Math key to activate Math setting menu as the following figure shown.  → 



Further press the F1 (Function)  key to enter the Math Function menu as the figure shown below.



Press F2 (dB) key to enable the dB  function. The screen, after activation, will appear as figure below.

dB result appears

Indicator dB On

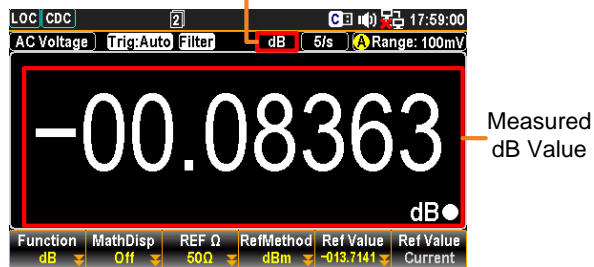

F3 (REF  $\Omega$ ) to select reference resistance

To change the reference resistance, press the F3 (REF  $\Omega$ ) key to enter the setting menu. Scroll the Knob key or press Number keys to enter the desired value of reference resistance.

**REF  $\Omega$**

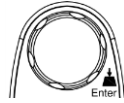

Push the F6 (Enter) key or the Knob key **Enter** or (Enter) to confirm the input reference resistance.

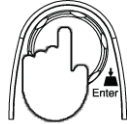

Resistance List 2, 4, 8, 16, 50, 75, 93, 110, 124, 125, 135, 150, 250, 300, 500, 600, 800, 900, 1000, 1200, 8000

F4 (Ref Method) to select dB reference method

Reference method involves the ways to calculate dB value. When dBm option is selected, user can specify a definite dBm value for dB calculation. If selecting Voltage option, system regards the defined voltage value as the Vreading parameter for dBm calculation, thus resulting in different dB value than the previous option.

Press the F4 (RefMethod) key to enter the dB Ref Method menu followed by clicking the F1 (Voltage) or F2 (dBm) key to determine which method of calculation to proceed to.

**RefMethod**

**Voltage**

**dBm**



F5 (Ref Value) to define reference value (voltage or dBm)

In order to define either voltage or dBm reference value, both of which are corresponding to the previous F4 (Ref Method) option, press the F5 (Ref Value) to enter the dB Ref Value menu, and use the Left/Right arrow keys to move cursor followed by scrolling the Knob key or pressing Number keys to enter the desired Ref value. Press the F6 (Enter) key or Knob key to confirm the input value.

**Ref Value**



**Enter**



Note

When setting voltage Ref value, press the function keys to promptly define the unit.

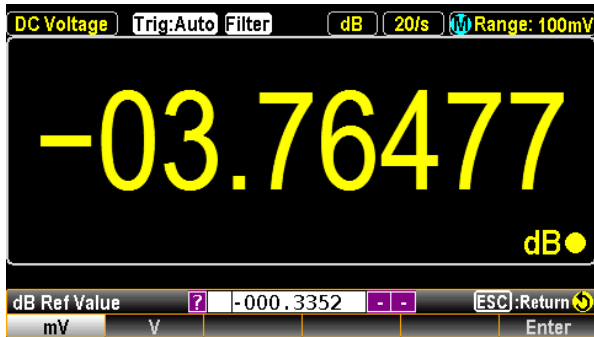

F6 (Ref Value) key to set the dBm reference

Press the F6 (Ref Value\_Current) key to instantly make the current dBm value, which is calculated by the current input voltage with the equation, as the Ref dBm (dBm reference).

**Ref Value Current**

F2 (MathDisp) key to show STAT & Math

Press the F2 (MathDisp) key to show the option menu as the figure below shown.

**MathDisp**

Proceed to the F2 (STAT) or F3 (Math) display in accord with the following chapters.





Show STAT result Background The STAT page in MathDisp allows you to make statistical calculations for several measurements including Minimum, Maximum, Average Peak-Peak, Standard Deviation and Count.

Operation Press the F2 (STAT) key  to show the statistical data immediately as the figure below.

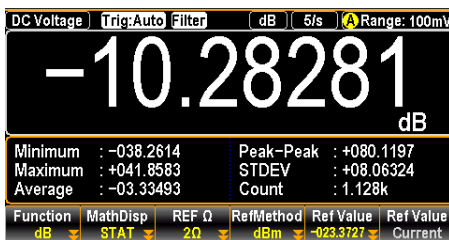

View Data	-10.28281 dB	Indicates the calculated dB value
	Minimum	Indicates the minimum data value
	Maximum	Indicates the maximum data value
	Average	Indicates the mean (average) value
	Peak-Peak	Indicates the peak to peak data
	STDEV	Indicates the standard deviation of the data
	Count	Indicates the latest counts of db

Show Math result Background The Math page in MathDisp allows you to view mathematical calculations for several parameters.

Operation

Press the F3 (Math) key  to show the mathematical analysis instantly as below.

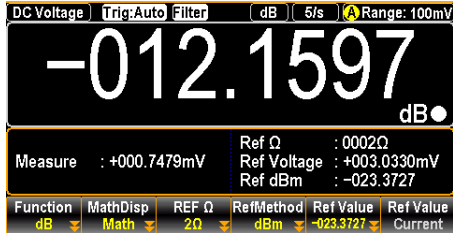

View Data	-012.1597	Indicates the calculated dB value
Measure:	+000.7479mV	Indicates the originally measured m Voltage value
Ref Ω:	0002 Ω	Indicates the defined reference resistance value
Ref Voltage:	+003.0330mV	Indicates the measured reference voltage value
Ref dBm:	-023.3727	Indicates the measured reference dBm value

Deactivate dB measurement

To cancel the dB measurement, press the F1 (Function) key followed by clicking F1 (OFF) to deactivate or simply activate another measurement.



## Compare Mode

Applicable to



Background

The Compare mode checks and updates if measurement data stays between the specified upper (high) and lower (low) limit.

Activate Compare mode

Press the Shift + Math key to activate Math setting menu as the following figure shown.

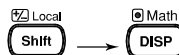

Further press the F1 (Function) key to enter the Math Function menu as the figure shown below.



Press F4 (Compare) key to enable the Compare function. The screen, after activation, will appear as figure below.



Indicator Compare On

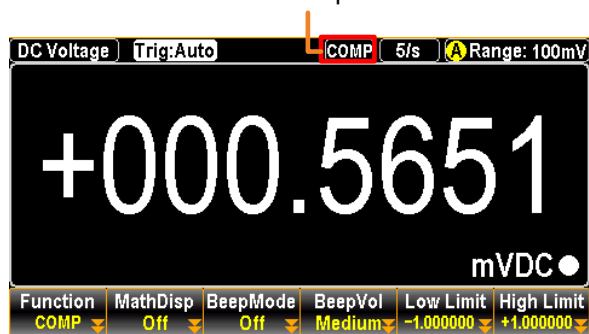

F6 (High Limit) to set high limit

Press the F6 (High Limit) key to enter the setting menu.





First use the functions keys to determine the unit, which varies by different measure modes. Then use the Left/Right arrow keys to move cursor and scroll the Knob key or press Number Keys to enter the desired value of high limit.



Push the F6 (Enter) key or the Knob key (Enter) to make the setting into effect.



F5 (Low Limit) to set low limit Press the F5 (Low Limit) key to enter the setting menu.



First use the functions keys to determine the unit, which varies by different measure modes. Then use the Left/Right arrow keys to move cursor and scroll the Knob key or press Number Keys to enter the desired value of low limit.



Push the F6 (Enter) key or the Knob key (Enter) to make the setting into effect.

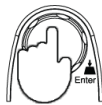

F3 (BeepMode) to define beep mode Press the F3 (BeepMode) key to enter the beep mode setting. By enabling beep mode, user can be aware of the latest state promptly by beep voice.



The display shows as the figure below.  
Press the F2 (Pass) or F3 (Fail) key to determine the condition of beep alarm.

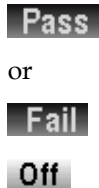

Press the F1 (Off) key to disable beep mode.



F4 (BeepVol) to select beep volume

Press the F4 (BeepVol) key to enter the beep volume setting.

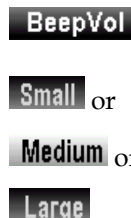

Select the intensity of beep volume via pressing F1 - F3 key for desired level as the figure shown below.



Compare mode result

When the measured result is within the range of high and low limit, the display shows as the figure below with purely black background indicating the state of "Pass".

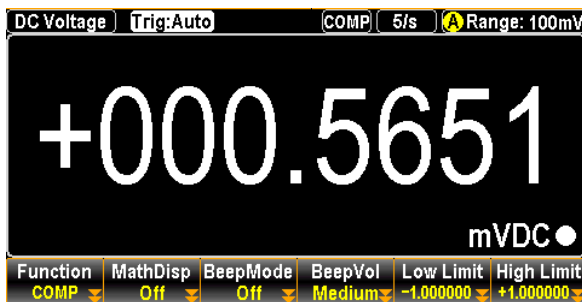

However, when measured result is either above or less than the limit range, the display appears as the figure below with boldly red background indicating the state of "Fail".

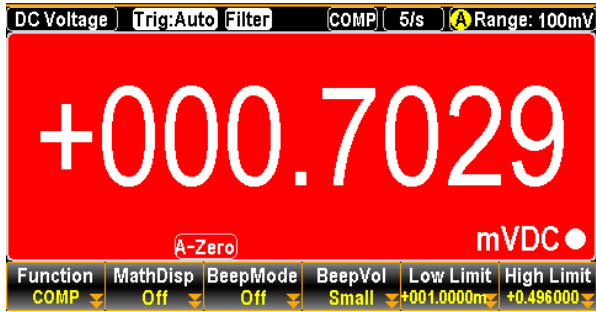

See the contents below for more details of each state in compare mode

**High** If the compare result is High, the relative pins of digital I/O port in action are as the follows.

Digital I/O: FAIL Out (Pin 6) and HIGH Limit FAIL Out (Pin 7) are activated.

**Low** If the compare result is Low, the relative pins of digital I/O port in action are as the follows.

Digital I/O: FAIL Out (Pin 6) and LOW Limit FAIL Out (Pin 8) are activated.

**Pass** If the compare result is Pass, the relative pin of digital I/O port in action is as the follows.

Digital I/O: PASS Out (Pin 5) is activated.

F2 (MathDisp) key Press the F2 (MathDisp) key to show **MathDisp** to show STAT, the Math Display menu as the figure below shown. Proceed to the F2 (STAT), F3 (Math) or F4 (Math+STAT) display in accord with the following chapters.



Show STAT result Background The STAT page in MathDisp allows you to make statistical calculations for several measurements including Minimum, Maximum, Average Peak-Peak, Standard Deviation and Count.

Operation Press the F2 (STAT) key  to show the statistical data as the figure below.

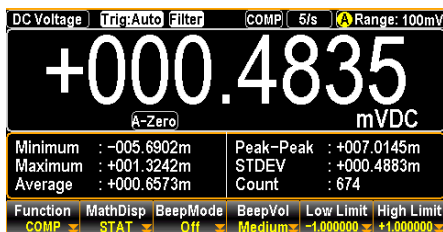

View Data +000.4835 mVDC Indicates the currently measured mVDC value

Minimum Indicates the minimum data value

Maximum Indicates the maximum data value

Average Indicates the mean (average) value

Peak-Peak Indicates the peak to peak data

STDEV Indicates the standard deviation of the data

Count Indicates the latest counts of compare

Show Math result Background The Math page in MathDisp allows you to view mathematical calculations for several parameters.

---

Operation

Press the F3 (Math) key  to show the mathematical analysis as the figure below.

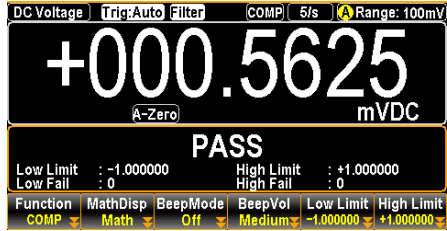

---

View Data

- +000.5625 mVDC** Indicates the currently measured mVDC value

---

- Low Limit** Indicates the defined low limit

---

- Low Fail** Indicates the counts of below the defined low limit

---

- High Limit** Indicates the defined high limit

---

- High Fail** Indicates the counts of above the defined high limit

---

Show Math+STAT Background result

The Math+STAT page in MathDisp allows you to view data from both statistical calculations and mathematical analysis.

---



Operation Press the F4 (Math+STAT) key **Math+STAT** to show the hybrid page of Math & STAT instantly as figure below.

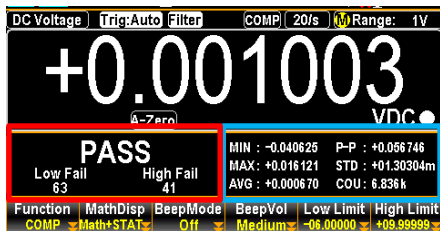

View Data +0.001003 VDC Indicates the currently measured mVDC value

Blue Section It is identical to the contents of STAT display. Refer to the previous chapter for details.

Red Section It is identical to the contents of Math display. Refer to the previous chapter for details.

Compare live-result in MathDispit's "Pass", "High" or "Low", will also appear within each mode of MathDisp. See the example below for the "High" result in Math+STAT mode.

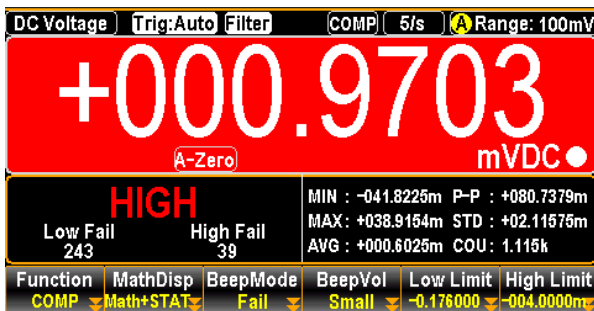

The boldly red background along with the indicator “HIGH” within the display means the compare result is over the range of defined high limit.

Digital I/O

The Compare measurement result comes out from the rear panel Digital I/O terminal.

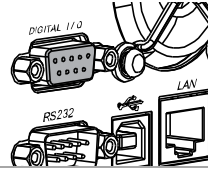

Deactivate Compare measurement

To cancel the Compare measurement, press the F1 (Function) key followed by clicking F1 (OFF) to deactivate or simply activate another measurement.

**Function**

**OFF**

## MX+B Measurement

Applicable to



Activate MX+B

Press the Shift + Math key to activate Math setting menu as the following figure shown.

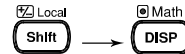

Further press the F1 (Function) key to enter the Math Function menu as the figure shown below.

**Function**



Press F5 (MX+B) key to enable the MX+B function. The screen, after activation, will appear as figure below.

**MX+B**

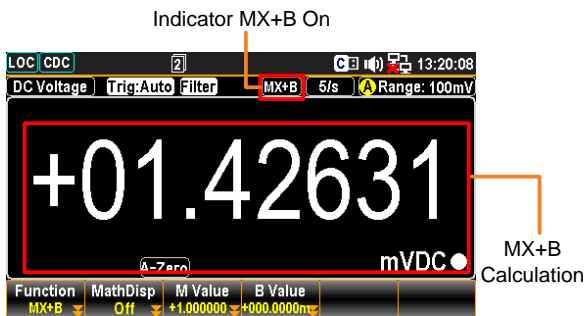

**F3 (M Value) key** Press the F3 (M Value) key to enter to set the factor M the MX+B M Value menu. First use function keys to decide unit value, which may vary by different measurements. Then use the Left/Right arrow keys to move cursor and scroll the Knob key or press Number keys to enter the desired value. See the figure below.

### M Value



Press the F6 (Enter) key or the Knob key until click to confirm the input M value.

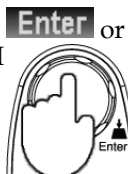

**F4 (B Value) key** Press the F4 (B Value) key to enter set the offset B the setting menu. First use function keys to decide unit value, which may vary by different measurements. Then use the Left/Right arrow keys to move cursor and scroll the Knob key or press Number keys to enter the desired value. See the figure below.

### B Value



Press the F6 (Enter) key or the Knob key until click to confirm the input B value.

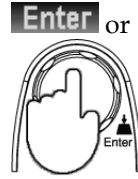

F2 (MathDisp) key Press the F2 (MathDisp) key to show the option menu as the figure below shown.



Proceed to the F2 (STAT) or F3 (Math) display in accord with the following chapters.



Show STAT result Background The STAT page in MathDisp allows you to make statistical calculations for several measurements including Minimum, Maximum, Average Peak-Peak, Standard Deviation and Count.

Operation Press the F2 (STAT) key **STAT** to show the statistical data immediately as the figure below.

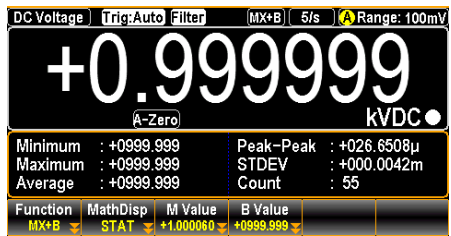

View Data +0.999999 kVDC Indicates the currently MX+B calculating result

Minimum Indicates the minimum data value

Maximum Indicates the maximum data value

---

Average      Indicates the mean (average) value

---

Peak-Peak    Indicates the peak to peak data

---

STDEV        Indicates the standard deviation of the data

---

Count         Indicates the latest counts of MX+B

---

Show Math result Background    The Math page in MathDisp allows you to view mathematical calculations for several parameters.

---

Operation      Press the F3 (Math) key  to show the mathematical analysis instantly as below.

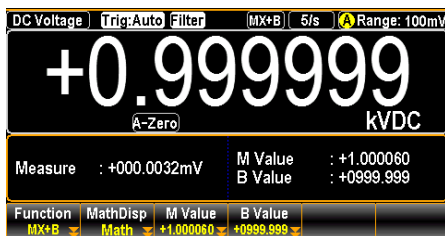

View Data      +0.999999 k    Indicates the currently VDC                    MX+B calculating result

---

Measure:        Indicates the originally +000.9389mV measured m Voltage value

---

M Value         Indicates the defined M value

---

B Value         Indicates the defined B value

---

**Deactivate MX+B measure** To cancel the MX+B measurement, press the F1 (Function) key followed by clicking F1 (OFF) key to deactivate or simply activate another measurement.

**Function**

**OFF**

## 1/X Measurement

Applicable to



Activate 1/X

Press the Shift + Math key to activate Math setting menu as the following figure shown.



Further press the F1 (Function) key to enter the Math Function menu as the figure shown below.

**Function**



Press F6 (More 1/2) key to enter the next page followed by pressing the F1 (1/X) key. The 1/X function will be activated as the figure below.

**More 1/2**

**1/X**

Indicator 1/X On

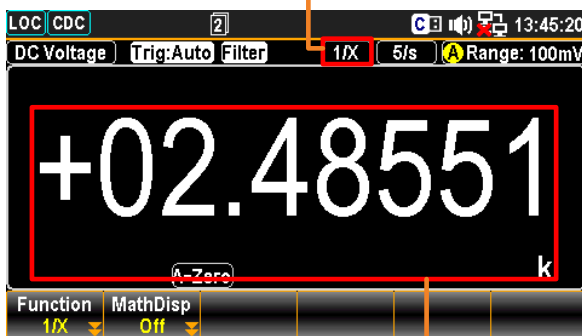

The Measured 1/X Value

F2 (MathDisp) key Press the F2 (MathDisp) key to show **MathDisp** to show STAT & the Math Display menu as the figure below shown. Proceed to the F2 Math (STAT) or F3 (Math) display in accord with the following chapters.



Show STAT result Background The STAT page in MathDisp allows you to make statistical calculations for several measurements including Minimum, Maximum, Average Peak-Peak, Standard Deviation and Count.

Operation Press the F2 (STAT) key **STAT** to show the statistical data as the figure below.

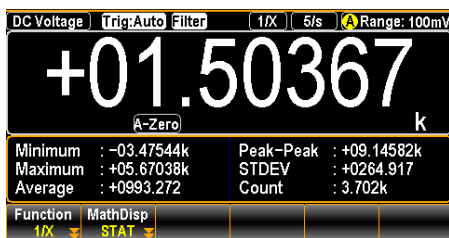

View Data +01.50367 k Indicates the 1/X calculation



Minimum	Indicates the minimum data value
Maximum	Indicates the maximum data value
Average	Indicates the mean (average) value
Peak-Peak	Indicates the peak to peak data
STDEV	Indicates the standard deviation of the data
Count	Indicates the latest counts of 1/X

Show Math result Background The Math page in MathDisp allows you to view mathematical calculations for several parameters.

Operation

Press the F3 (Math) key  to show the mathematical analysis as the figure below.

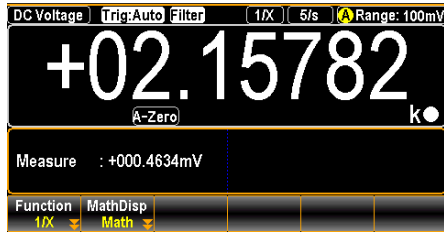

View Data	+02.15782k	Indicates the 1/X calculation
	Measure: +000.4634	Indicates the originally measured m Voltage value

Deactivate 1/X measurement

To cancel the 1/X measurement, press the F1 (Function) key followed by clicking the F1 (OFF) key to deactivate or simply activate another measurement.





## Measure Percent

Applicable to

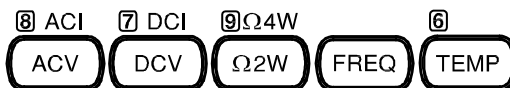

Activate percent

Press the Shift + Math key to activate Math setting menu as the following figure shown.

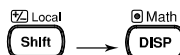

Further press the F1 (Function) key to enter the Math Function menu as the figure shown below.



Press F6 (More 1/2) key to enter the next page followed by pressing the F2 (Percent) key. Percent function will be activated as the following figure shown.



Indicator Percent On

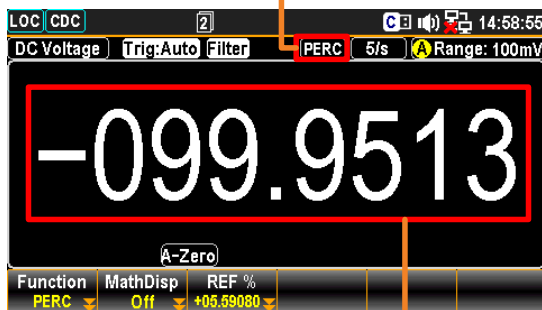

The Measured Percent Value



F3 (REF %) key to set reference % Press the F3 (REF %) key to enter the Percent REF % menu. First use the functions keys to determine the unit, which may vary by different measure modes. Then use the Left/Right arrow keys to move cursor and scroll the Knob key or press Number keys to enter the desired value. See the figure below.

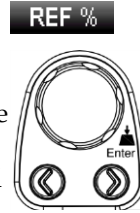

Push the Knob key (Enter) or press the F6 (Enter) key to confirm the input value.

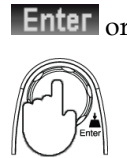

F2 (MathDisp) key to show STAT & Math Press the F2 (MathDisp) key to show the option menu as the figure below shown.



Proceed to the F2 (STAT) or F3 (Math) display in accord with the following chapters.



Show STAT result Background The STAT page in MathDisp allows you to make statistical calculations for several measurements including Minimum, Maximum, Average Peak-Peak, Standard Deviation and Count.

Operation Press the F2 (STAT) key **STAT** to show the statistical data immediately as the figure below.

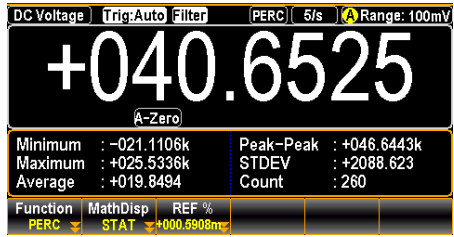

View Data	+040.6525	Indicates the Percent calculation
Minimum	-021.1106k	Indicates the minimum data value
Maximum	+025.5336k	Indicates the maximum data value
Average	+019.8494	Indicates the mean (average) value
Peak-Peak	+046.6443k	Indicates the peak to peak data
STDEV	+2088.623	Indicates the standard deviation of the data
Count	260	Indicates the latest counts of Percent

Show Math result Background The Math page in MathDisp allows you to view mathematical calculations for several parameters.

Operation Press the F3 (Math) key  to show the mathematical analysis instantly as below.

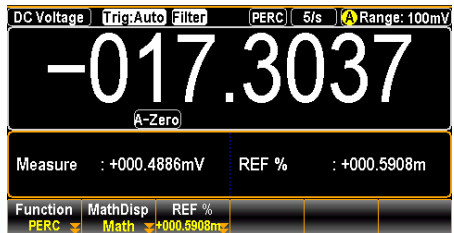

---

View Data	-017.3037	Indicates the Percent calculation
Measure:	+000.4886mV	Indicates the originally measured m Voltage value
Ref %:	+000.5908m	Indicates the defined reference % value

---

Deactivate percent measurement To cancel the percent measurement, press the F1 (Function) key followed by clicking F1 (OFF) to deactivate or simply activate another measurement.

---





# Digital I/O Overview

---

**Background** The Digital I/O port is a triple function port. By default (Compare Mode) the port is used with the compare function to output Hi Fail, Lo Fail, Pass, and EOM (end of measurement) signals. In addition, there is also a TRIG IN input pin.

As a secondary function (4094 Mode) and third function (User Mode), the Digital I/O port can have the output state of pins 5 ~ 8 controlled via remote control.

By providing separate VCC power for the terminal, the outputs can also be used as a power source for TTL and CMOS circuits.

---

**Related Commands** DIGital:INterface:MODE ?  
 DIGital:INterface:MODE {COMP | 4094 | IO}  
 DIGital:INterface:DATA:OUTPut (For 4094 Mode)  
 DIGital:INterface:DATA:SETup (For User Mode)

---

**Pin Assignment**

Connector type: DB-9 female

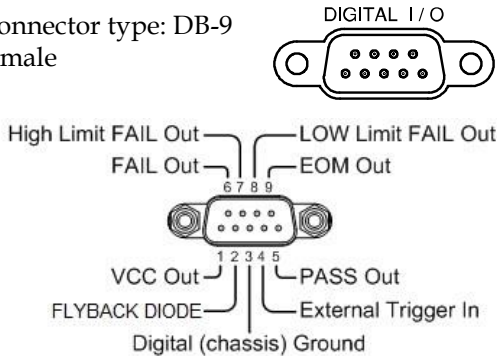

Pin No	Compare Mode	4094 Mode	User Mode
1	VCC Out	VCC Out	VCC Out
2	Flyback Diode	Flyback Diode	Flyback Diode
3	Digital Ground	Digital Ground	Digital Ground
4	External Trigger In	External Trigger In	External Trigger In
5	Pass Out	Clock	OUT1
6	Fail Out	Output Enable	OUT2
7	High Limit Fail Out	Fail Strobe	OUT3
8	Low Limit Fail Out	Serial Input	OUT4
9	EOM Out	EOM Out	EOM Out
Pin1	VCC output, 5V. Serves as the unregulated max power source for the external device/logic. The maximum current is 100mA.		
Pin2	Flyback Diode. Connect to VCC or External power source.		
Pin3	Digital (chassis) Ground.		
Pin4	External Trigger Input. Accepts external trigger signals. For using external signals.		

---

### Pins 3-4 output wiring diagram

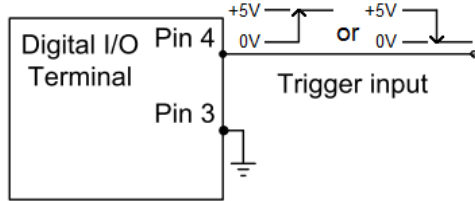

---

Pin5-8 Pin 5-8 are designed as composite pins, which can be specified by user for diversified functions as follows:

Compare/4094/User Mdoe

Refer to the page 14 for details of Compare Mode, and the page 20 for details of 4094/User Mode.

---

### Pins 5-8 output wiring diagram

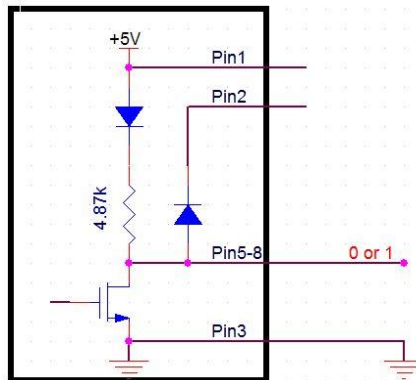



---

Pin9 EOM (End Of Measurement) signal Output. Activates when compare measurement is over. It is also available in other measurements.

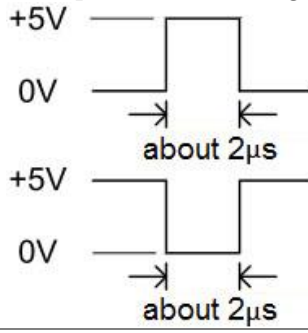

EOM pulse width timing



# Application: Compare Mode

Applicable to



Background

The Compare Mode outputs the pass/fail results of the Compare function. Each signal is an active low signal. In addition, an active low pulse of approximately 2μs is output to indicate the end of compare measurement (EOM).

When the input signal exceeds the high threshold or the low threshold, the High Fail or Low Fail pin is pulled low. When the signal stays within the threshold levels, the Pass pin is pulled low.

Pin Assignment

Pin No	Compare Mode	Description
1	VCC Out	Option(Vcc)
2	Flyback Diode	No Use
3	Digital Ground	GND
5	Pass	Out
6	Fail	Out
7	High Limit Fail	Out
8	Low Limit Fail	Out

Activate Compare mode

Press the Shift + Math key to activate Math setting menu as the following figure shown.

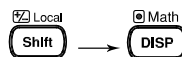

Further press the F1 (Function) key to enter the Math Function menu as the figure shown below.



Press F4 (Compare) key to enable the Compare function. The screen, after activation, will appear as figure below.

**Compare**

Indicator Compare On

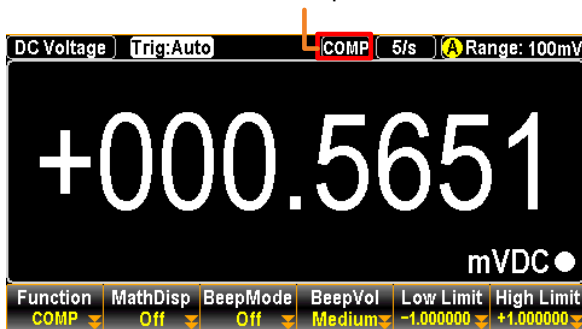

F6 (High Limit) to set high limit Press the F6 (High Limit) key to enter the setting menu.

**High Limit**



First use the functions keys to determine the unit, which varies by different measure modes. Then use the Left/Right arrow keys to move cursor and scroll the Knob key or press Number Keys to enter the desired value of high limit.

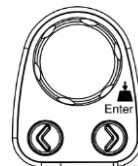

Push the F6 (Enter) key or the Knob key (Enter) to make the setting into effect.

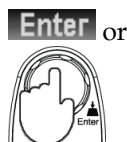

F5 (Low Limit) to set low limit Press the F5 (Low Limit) key to enter the setting menu.

**Low Limit**



First use the functions keys to determine the unit, which varies by different measure modes. Then use the Left/Right arrow keys to move cursor and scroll the Knob key or press Number Keys to enter the desired value of low limit.



Push the F6 (Enter) key or the Knob key (Enter) to make the setting into effect.

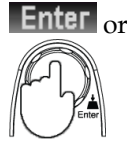

F3 (BeepMode) to Press the F3 (BeepMode) key to enter define beep mode the beep mode setting. By enabling beep mode, user can be aware of the latest state promptly by beep voice.

**BeepMode**

The display shows as the figure below. Press the F2 (Pass) or F3 (Fail) key to determine the condition of beep alarm.

**Pass**

or

**Fail**

Press the F1 (Off) key to disable beep mode.

**Off**



F4 (BeepVol) to select beep volume

Press the F4 (BeepVol) key to enter the beep volume setting.

**BeepVol**

Select the intensity of beep volume via pressing F1 – F3 key for desired level as the figure shown below.

**Small** or

**Medium** or

**Large**



Compare mode result

When the measured result is within the range of high and low limit, the display shows as the figure below with purely black background indicating the state of "Pass".

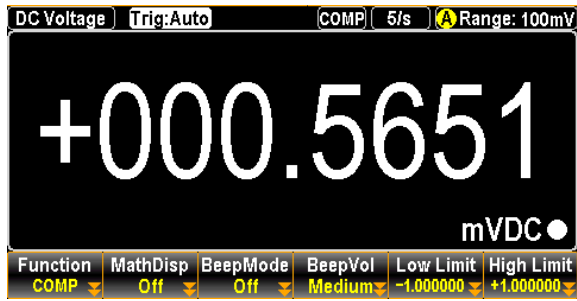

However, when measured result is either above or less than the limit range, the display appears as the figure below with boldly red background indicating the state of “Fail”.

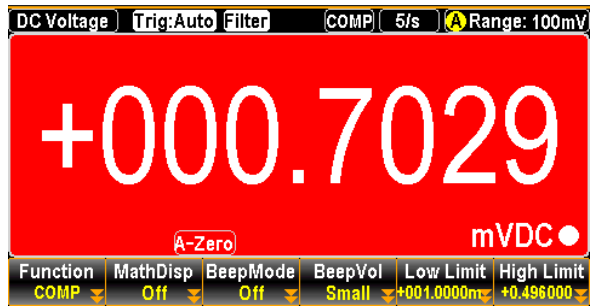

See the contents below for more details of each state in compare mode

**High** If the compare result is High, the relative pins of digital I/O port in action are as the follows.

Digital I/O: FAIL Out (Pin 6) and HIGH Limit FAIL Out (Pin 7) are activated.

**Low** If the compare result is Low, the relative pins of digital I/O port in action are as the follows.

Digital I/O: FAIL Out (Pin 6) and LOW Limit FAIL Out (Pin 8) are activated.

Pass If the compare result is Pass, the relative pin of digital I/O port in action is as the follows.

Digital I/O: PASS Out (Pin 5) is activated.

F2 (MathDisp) key Press the F2 (MathDisp) key to show **MathDisp** to show STAT, the Math Display menu as the figure below shown. Proceed to the F2 (STAT), F3 (Math) or F4 (Math+STAT) display in accord with the following chapters.



Show STAT result Background The STAT page in MathDisp allows you to make statistical calculations for several measurements including Minimum, Maximum, Average Peak-Peak, Standard Deviation and Count.

Operation Press the F2 (STAT) key **STAT** to show the statistical data as the figure below.

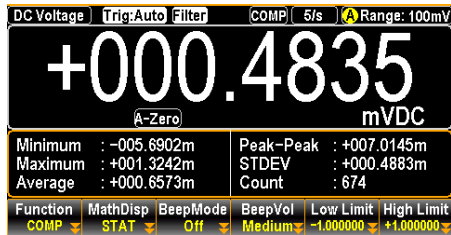

View Data +000.4835 mVDC Indicates the currently measured mVDC value

---

Minimum Indicates the minimum data value

---

Maximum Indicates the maximum data value

---

Average Indicates the mean (average) value

Peak-Peak	Indicates the peak to peak data
STDEV	Indicates the standard deviation of the data
Count	Indicates the latest counts of compare

Show Math result Background The Math page in MathDisp allows you to view mathematical calculations for several parameters.

Operation Press the F3 (Math) key  to show the mathematical analysis as the figure below.

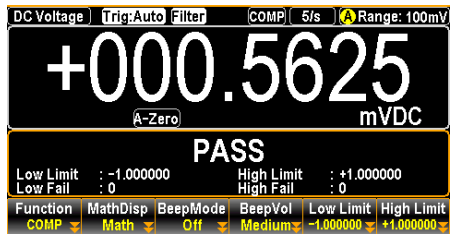

View Data +000.5625m VDC Indicates the currently measured mVDC value

Low Limit Indicates the defined low limit

Low Fail Indicates the counts of below the defined low limit

High Limit Indicates the defined high limit

High Fail Indicates the counts of above the defined high limit

Show Math+STAT result Background The Math+STAT page in MathDisp allows you to view data from both statistical calculations and mathematical analysis.



Operation Press the F4 (Math+STAT) key **Math+STAT** to show the hybrid page of Math & STAT instantly as figure below.

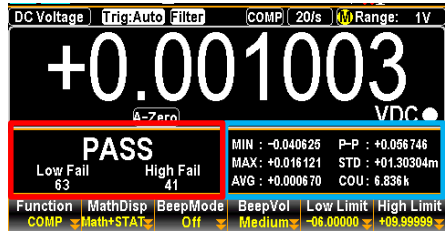

View Data +0.001003 VDC Indicates the currently measured mVDC value

Blue Section It is identical to the contents of STAT display. Refer to the previous chapter for details.

Red Section It is identical to the contents of Math display. Refer to the previous chapter for details.

Compare live-result in MathDisp

The latest state of compare measurement, whether it's "Pass", "High" or "Low", will also appear within each mode of MathDisp. See the example below for the "High" result in Math+STAT mode.

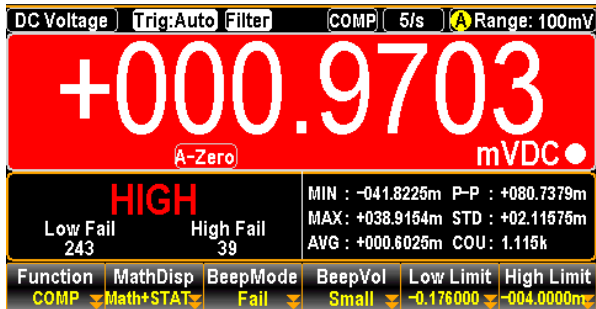

The boldly red background along with the



indicator “HIGH” within the display means the compare result is over the range of defined high limit.

Timing Diagram for pins 5-8 when the Compare function is activated

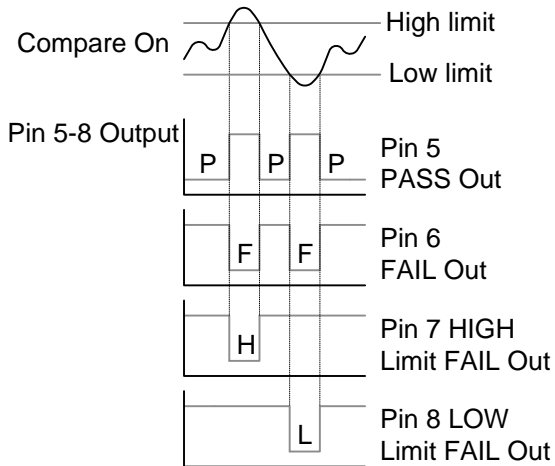

Deactivate Compare measurement

To cancel the Compare measurement, press the F1 (Function) key followed by clicking F1 (OFF) to deactivate or simply activate another measurement.

**Function**

**OFF**



## Application: 4094 / User Mode

---

**Overview** 4094 and User mode can only be used when using a remote control interface. Likewise this mode can only be enabled or disabled via remote control. Please see the digital I/O commands on page 259 for full usage details.

### User Mode – IO (Output) Mode

---

**Overview** It is the mode utilizing output as general IO (Output) usage with up to 4 pins available for use simultaneously. Refer to the following introductions along with diagrams for more details. Please see the digital I/O commands on page 259 for full usage details.

**Related Commands** DIG:INT:MODE IO (switch to IO mode)  
 DIG:INT:DATA:SET 0,1,1,0  
 => OUT1(Pin5) : +0V  
       OUT2(Pin6) : +5V  
       OUT3(Pin7) : +5V  
       OUT4(Pin8) : +0V

Pin Assignment	Pin No	User Mode	Description
	1	VCC Out	Option(Vcc:+5V)
	2	Flyback Diode	No Use
	3	Digital Ground	GND
	5	OUT1	Use
	6	OUT2	Use
	7	OUT3	Use
	8	OUT4	Use

Pin Diagram

\* Use the built-in power supply

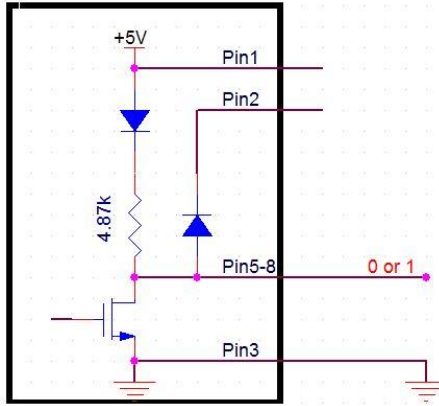

Note: Pin1 and Pin2 Not in use

\* Use in conjunction with the logic gate

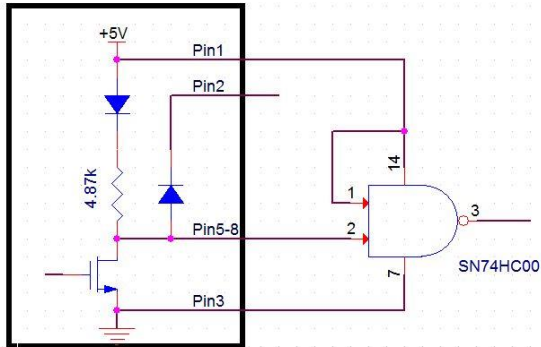

Note: Pin2 Not in use

## User Mode – Switch Mode (LED)

---

**Overview** It is the mode driving LED as status display for user with up to 4 pins available for use simultaneously. Refer to the following introductions along with diagrams for more details. Please see the digital I/O commands on page 259 for full usage details.

---

**Related Commands** DIG:INT:MODE IO (switch to IO mode)  
 DIG:INT:DATA:SET 1,0,0,1  
 => OUT1(Pin5) : LED OFF  
       OUT2(Pin6) : LED ON  
       OUT3(Pin7) : LED ON  
       OUT4(Pin8) : LED OFF

---

Pin Assignment	Pin No	User Mode	Description
	1	VCC Out	Option(Vcc:+5V)
	2	Flyback Diode	No Use
	3	Digital Ground	Option(GND)
	5	OUT1	Use
	6	OUT2	Use
	7	OUT3	Use
	8	OUT4	Use

---

Pin Diagram

\* Use the built-in power supply

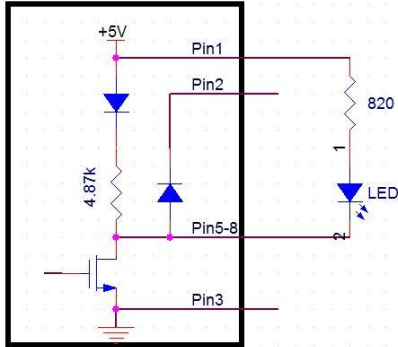

Note: Pin2 and Pin3 Not in use

\* Use the external power

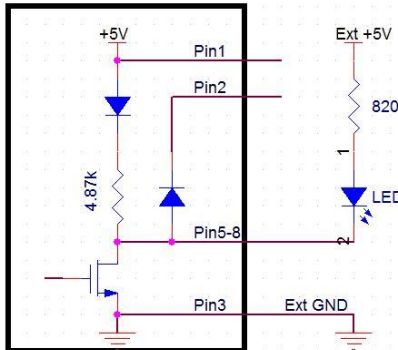

Note: Pin1 and Pin2 Not in use

## User Mode – Switch Mode (Relay)

---

**Overview** It is the mode driving Relay to control external circuit with up to 4 pins available for use simultaneously. Refer to the following introductions along with diagrams for more details. Please see the digital I/O commands on page 259 for full usage details.

---

**Related Commands** DIG:INT:MODE IO (switch to IO mode)  
 DIG:INT:DATA:SET 1,0,1,0  
 => OUT1(Pin5) : RELAY OFF  
 OUT2(Pin6) : RELAY ON  
 OUT3(Pin7) : RELAY OFF  
 OUT4(Pin8) : RELAY ON

---

Pin Assignment	Pin No	User Mode	Description
	1	VCC Out	Option(Vcc:+5V)
	2	Flyback Diode	Use (connect to Pin1 or Ext Vcc)
	3	Digital Ground	GND
	5	OUT1	Use
	6	OUT2	Use
	7	OUT3	Use
	8	OUT4	Use

---

Pin Diagram

\* Use the built-in power supply which provides the power of maximum 100mA

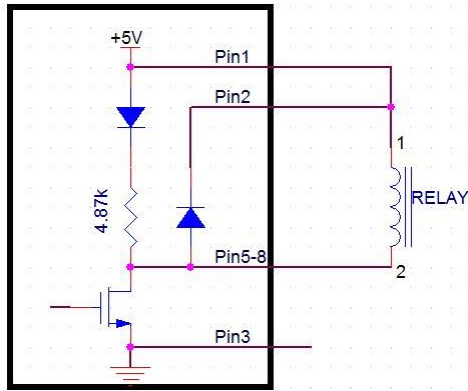

⚠ Note: Pin3 Not in use

\* Use the external power (+5~24V) (Maximum Ids of each channel: 400mA)

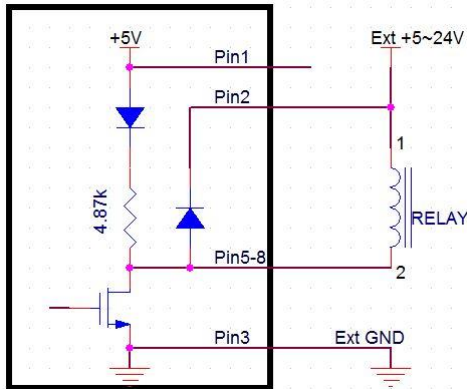

⚠ Note: Connect Pin2 to Ext Vcc

## 4094 Mode

### Overview

It is the mode for IO expansion via converting serial data into parallel data. Up to 8 pins are available simultaneously when single 4094 is in operation, whereas it rises to the maximum of 16 pins available simultaneously if putting two 4094 in series. Refer to the following introductions along with diagrams for more details. Please see the digital I/O commands on page 259 for full usage details.

### Related Commands

DIG:INT:MODE 4094 (switch to 4094 mode)

**4094 x 1(8 Pin)**

DIG:INT:DATA:OUTP 10 , 1

=> 4094 Output(Out1~Out8) : 01010000

**4094 x 2(16 Pin)**

DIG:INT:DATA:OUTP 22,0

DIG:INT:DATA:OUTP 88,1

=> 4094 Output(Out1~Out8) : 01101000  
(Out9~Out16): 00011010



Note: 0=> output is Low (+0V); 1=> output is High (+5V)

### Pin Assignment

Pin No	4094 Mode	Description
1	VCC Out	Option(Vcc:+5V)
2	Flyback Diode	Option (connect to Pin1)
3	Digital Ground	GND
5	Clock	Use
6	Output Enable	Option (connect to Vcc when not in use)
7	Strobe	Use



## 8 Serial Input Use

### Pin Diagram

\* Use the built-in power supply

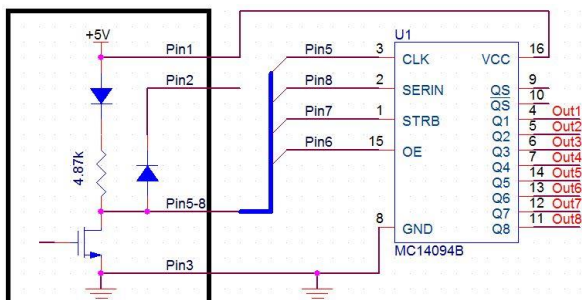

⚠ Note: Pin2 Not in use

\* Use the external power

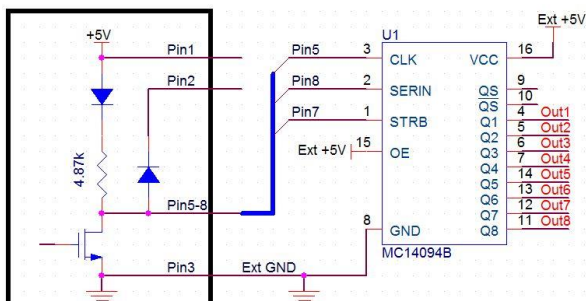

⚠ Note: Pin1 and Pin2 Not in use

\* Method of series

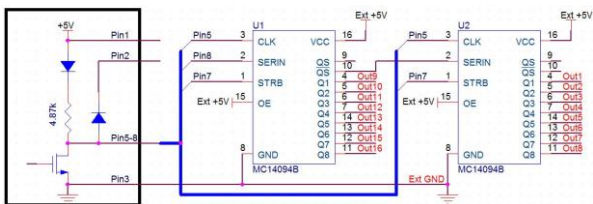

⚠ Note: Pin1 and Pin2 Not in use

# Application: External Trigger

## Background

The external trigger uses the digital I/O pin for manual triggering of the RSDM-9060/9061. To trigger the RSDM-9060/9061 a pulse of  $\geq 10\mu\text{s}$  is needed.

The READ? command can also be used to externally trigger the RSDM-9060/9061 when the RSDM-9060/9061 is in the external trigger mode. See page xxx for details.

**Signal connection** Connect the external trigger signal to the Digital I/O port located on the rear panel.

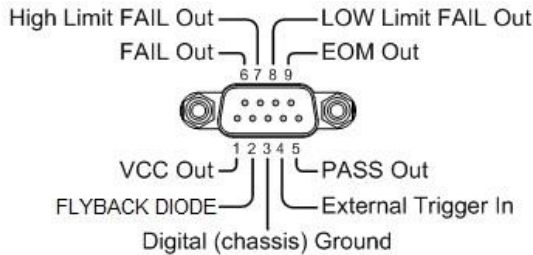

Pin4 External Trigger Input pin

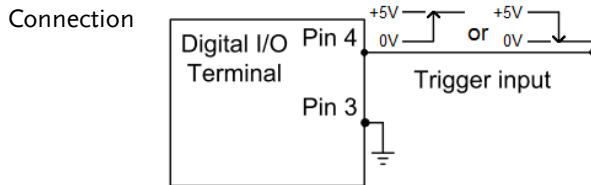

Activate external trigger

Press the Shift + TRIG key to activate setting menu of trigger.

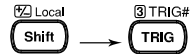

Press the F1 (TrigSource) key to enter the trigger source menu followed by pressing the F3 (EXT) to select External Trigger mode.

**TrigSource**



The “EXT” indicator appears on the display.



External Trigger Mode

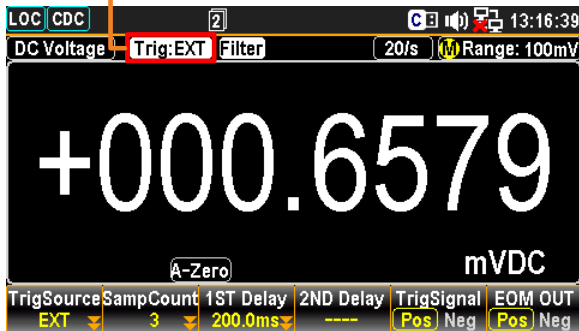

Reading indicator The reading indicator  does not flash before triggering (can be on or off). After triggering, the indicator flashes according to the external signal trigger timing.

Exit external trigger Press the Shift key followed by the TRIG key. The EXT indicator disappears and the trigger goes back to internal mode.

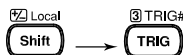



# SYSTEM & FIRMWARE

---

View System Info.....	161
Firmware Update.....	162

# View System Info

**Background** View system information including Vendor, Model Name, Serial Number, Master Firmware and Slave Firmware.

- Step**
1. Press the Menu key, the System configuration menu appears. And press the NEXT key repeatedly or scroll the Knob key to move to the Security&Info - SystemInfo field.

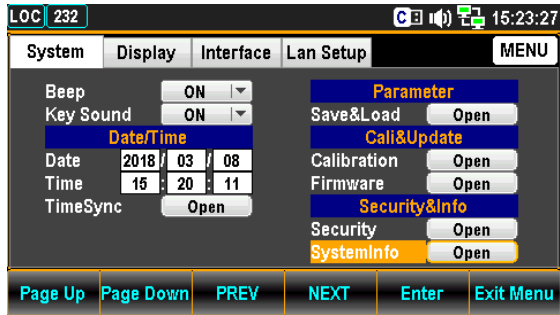
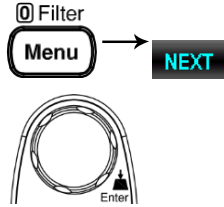

2. Press the F5 (Enter) key or Knob key to enter the System Information where all the critical contents are exposed for check.

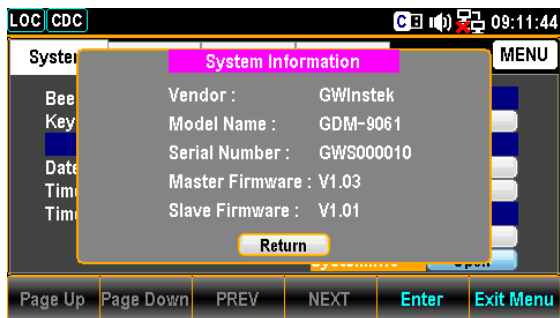

# Firmware Update

**Background** This section is for updating the latest firmware.

- Step**
1. Press the Menu key, the System configuration menu appears. And press the NEXT key repeatedly or scroll the Knob key to move to the Cali&Update - Firmware field.

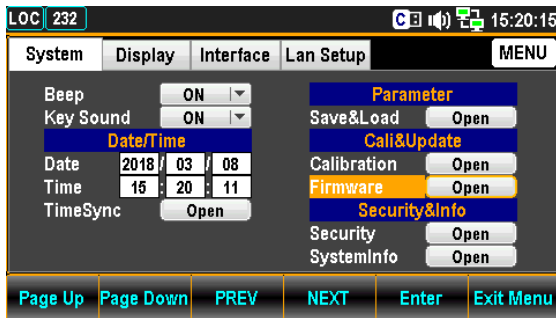

Press the F5 (Enter) key or Knob key to enter the Firmware Update menu.

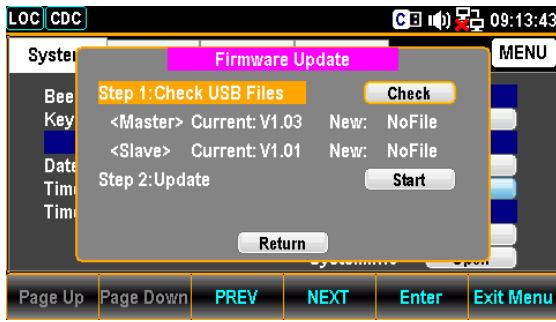

**Firmware Update Process** Update  
 Prior to update, make sure if the required firmware file is stored within the flash drive plugged into the USB port on the front panel. Also, user can check the current Master and Slave firmware version respectively in this menu.



Note

Prior to update, please rename the downloaded firmware files as below:

Master file: M\_IMAGE.bin

Slave file: S\_IMAGE.bin

1. Press the F5 (Enter) key or Knob key first, the qualified firmware version will show then.



Note

If flash drive has no update files, it will show as the figure below.



2. Press the NEXT key or scroll Knob key to move to the Update followed by pressing the F5 (Enter) key or Knob key to Start update.





# MENU SETTING

---

Configure System .....	166
Beep Setting .....	166
Key Sound Setting .....	167
Date Setting .....	168
Time Setting .....	169
TimeSync Setting .....	171
Save and Load Setting .....	172
Calibration Setting .....	179
Firmware Update .....	183
Security Setting .....	185
View System Info .....	187
Configure Display .....	189
Brightness Setting .....	189
Auto Off Setting .....	190
Auto Off Time Setting .....	192
1ST Color Setting .....	194
2ND Color Setting .....	196
Math Color Setting .....	198
Display Mode Setting .....	200
Anti Aliasing Setting .....	205
Additional Info Setting .....	207
Language Setting .....	209

# Configure System

## Beep Setting

Background Enable or Disable Beep Sound.

Step

1. Press the Menu key, the System configuration menu appears.

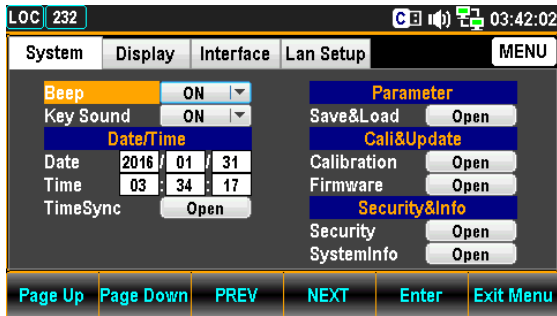

2. Press the F5 (Enter) key or Knob key followed by scrolling Knob key or pressing +/- keys to land on the ON option.

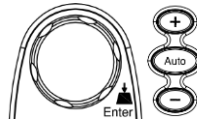

**Enter**

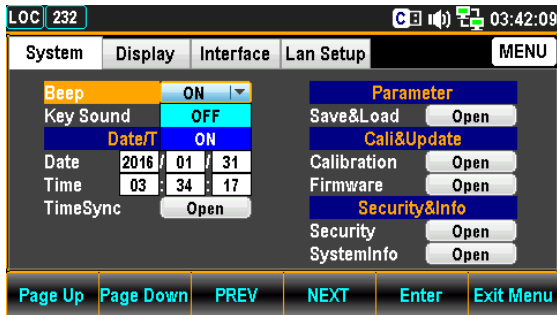

3. Press the F5 (Enter) key or Knob key to select the ON option.

**Enter**

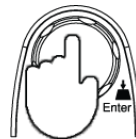

## Key Sound Setting

Background Enable or Disable Key Sound.

Step

1. Press the Menu key, the System configuration menu appears. And then press the NEXT key repeatedly or scroll the Knob key to move to the Key Sound field.

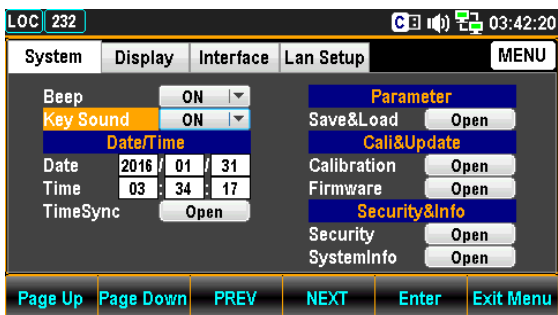
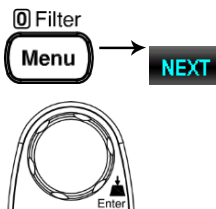

2. Press the F5 (Enter) key or Knob key followed by scrolling Knob key or pressing +/- keys to land on the On option.

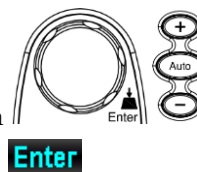

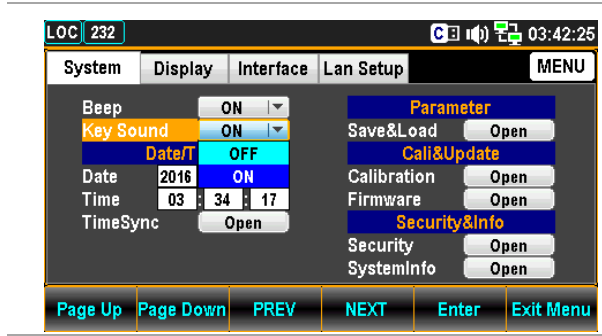

3. Press the F5 (Enter) key or Knob key to select the ON option for Key Sound.



## Date Setting

### Background

Manually adjust date for system or automatically set date via TimeSync setting.

### Step

1. Press the Menu key, the System configuration menu appears. And press the NEXT key repeatedly or scroll the Knob key to move to the Date/Time - Date field.

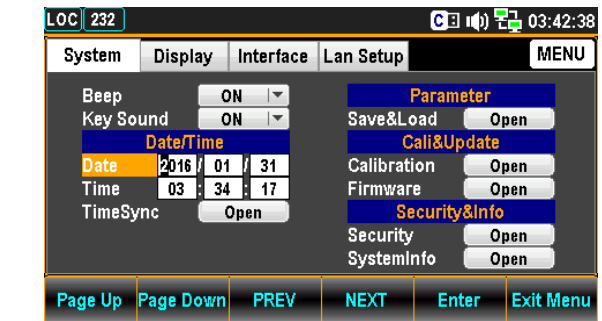
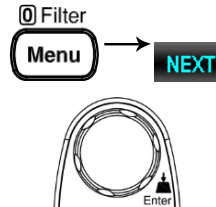

- Use the Left/Right keys to move the cursor followed by scrolling Knob key or pressing +/- keys to define year of Date. Also, you can press Number keys to directly input a specific digit.

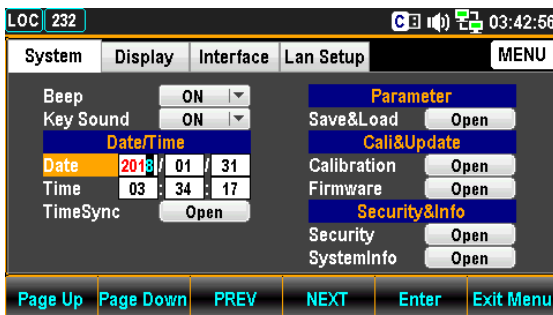
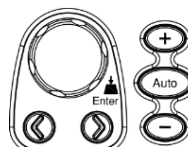

- Press the F5 (Enter) key or Knob key to confirm the input digit for year of Date.

Enter



- Repeat steps 2 to 3 for month and day.

## Time Setting

### Background

Manually adjust time for system or automatically set time via TimeSync setting.

### Step

- Press the Menu key, the System configuration menu appears. And press the NEXT key repeatedly or scroll the Knob key to move to the Date/Time - Time field.

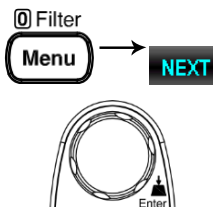

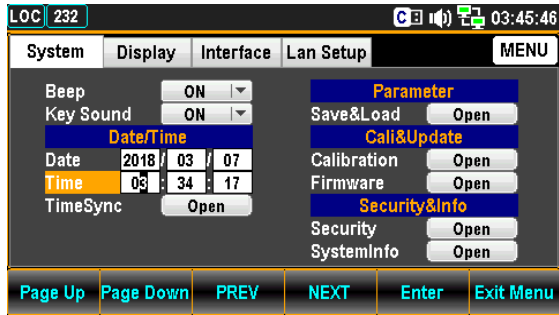

- Use the Left/Right keys to move the cursor followed by scrolling Knob key or pressing +/- keys to define hour of Time. Also, you can press Number keys to directly input a specific digit.

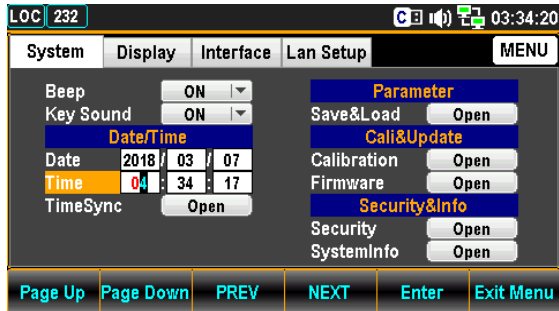
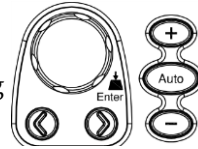

- Press the F5 (Enter) key or Knob key to confirm the input digit for hour of Time.



- Repeat steps 2 to 3 for minute and second.

## TimeSync Setting

**Background** TimeSync is only available when connecting to internet with appropriate network setting.

- Step**
1. Press the Menu key, the System configuration menu appears. And press the NEXT key repeatedly or scroll the Knob key to move to the Date/Time - TimeSync field.

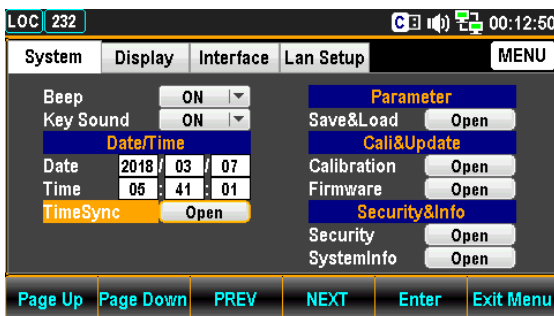
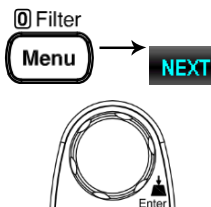

2. Press the F5 (Enter) key or Knob key to enter the Internet Time Sync menu.

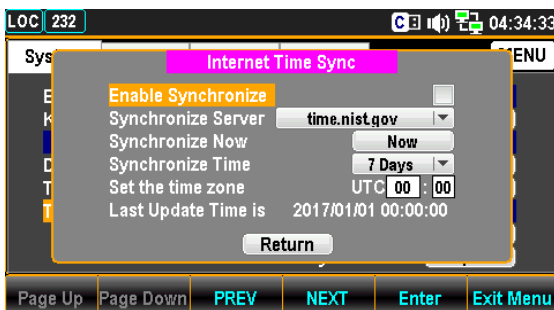

Internet Time Synchronize	Enable Synchronize	Enable or disable time sync Check / Uncheck
	Synchronize Server	Choose remote server for time sync time.nust.gov / time-nw.nist.gov The 2nd server is available for user customization. Refer to page 154 for SCPI setting.
	Synchronize Now	Retrieve the currently standard time from the remote sever.
	Synchronize Time	Define an interval to retrieve the currently standard time from the remote sever. 7 Days / 14 Days / 30 Days
	Set the time zone	Set UTC (Coordinated Universal Time) hour / minute
	Last Update Time is	Display the currently standard time.

## Save and Load Setting

---

Background	<p>The RSDM-906X can save up to 5 instrument settings.</p> <p>The settings can save the state, function, I/O and range.</p> <p>The Recall function enables saved settings or default settings to be recalled at the next power up or immediately.</p>
------------	---



Step

1. Press the Menu key, the System configuration menu appears. And press the NEXT key repeatedly or scroll the Knob key to move to the Parameter - Save&Load field.

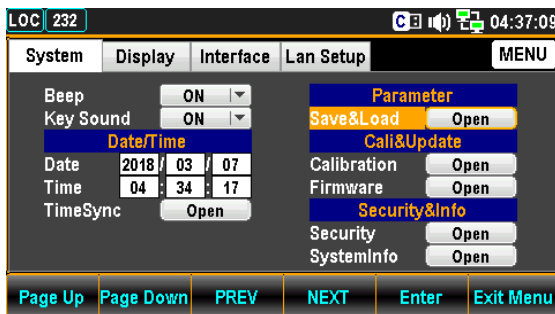
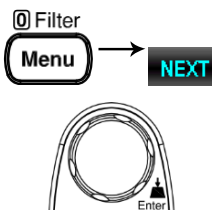

2. Press the F5 (Enter) key or Knob key to enter the Parameter Save&Load menu.

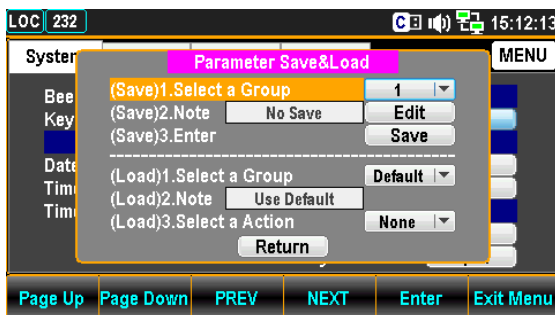

## Parameter Save & Save Load

Select a Group

1. Press the F5 (Enter) key or Knob key to open the dropdown menu.

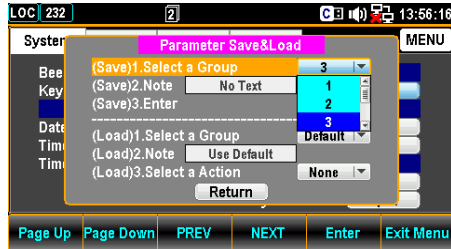

2. Scroll the Knob key or pressing +/- keys followed by pressing the F5 (Enter) key or Knob key to confirm the group selection.

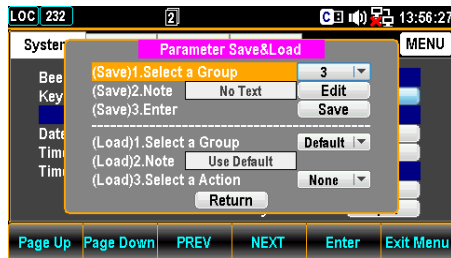
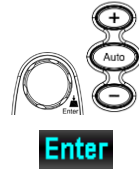

Note

1. Press the F5 (Enter) key or Knob key to open the KeyBoard page.





2. Press the F2 (Backspace) key to clear default words. Backspace



3. Use the Left/Right and +/- keys or scroll the Knob key to move the cursor to desired word followed by pressing the F5 (Input) key or Knob key to input the word. Input

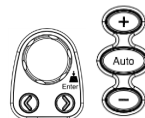

- Press the F4 (OK) or the Knob key to confirm the input words.

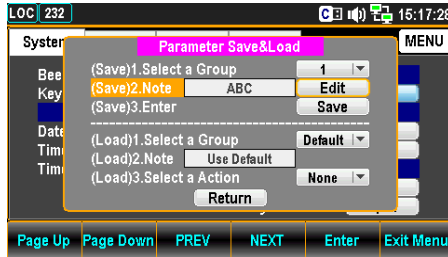

Enter

- Press the F5 (Enter) key or Knob key to saved the input words.

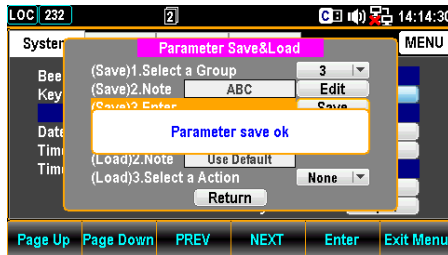

Load

Select a Group

- Press the F5 (Enter) key or Knob key to open the dropdown menu.

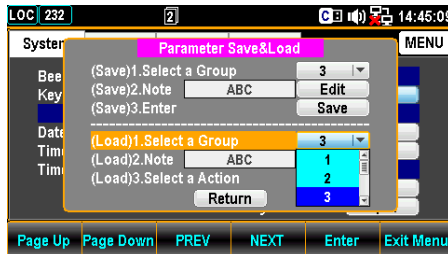

2. Scroll the Knob key or press +/- keys followed by pressing the F5 (Enter) key or Knob key to confirm the group selection.

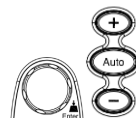

**Enter**

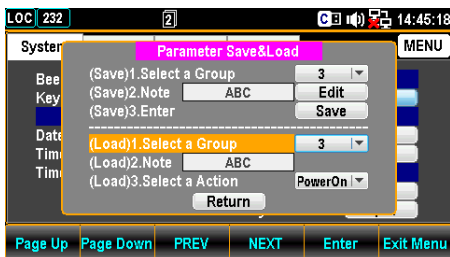

- Note
1. The currently selected group name appears in the Note field.



- Select a Action
1. Press the F5 (Enter) key or Knob key to open the dropdown menu.

**Enter**

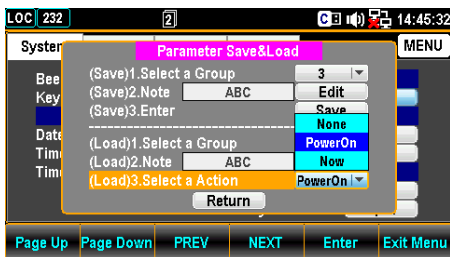

2. Scroll the Knob key or press +/- keys followed by pressing the F5 (Enter) key or Knob key to confirm the action selection.

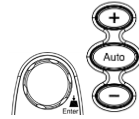

Enter

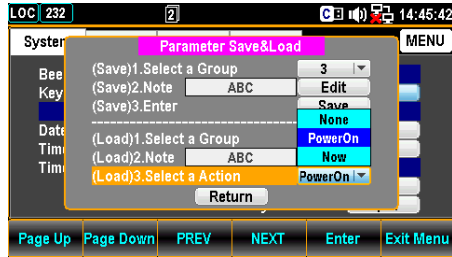

3. Press the F5 (Enter) key or Knob key to confirm the action selection.



Enter

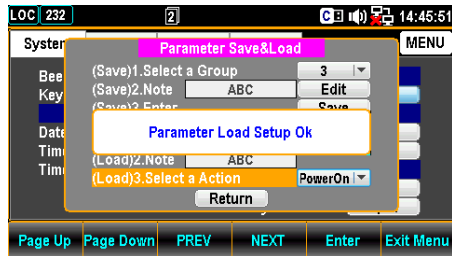

Parameter None: no recall action

Power On: recall at next power up

Now: recall instantly

## Calibration Setting

**Background** This section mainly provides several calibrations for frequency, DC gain and DMM. Note that only the certified technician can operate the calibration procedure. Refer to the qualified personnel for more details when necessary.

**Step**

1. Press the Menu key, the System configuration menu appears. And press the NEXT key repeatedly or scroll the Knob key to move to the Cali&Update - Calibration field.

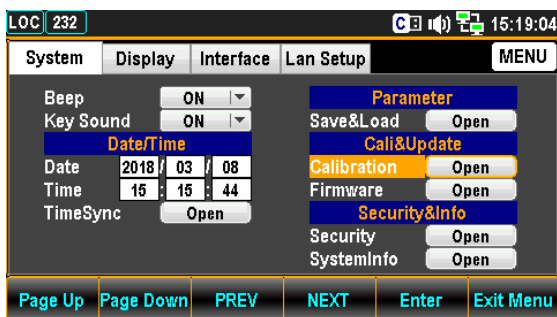
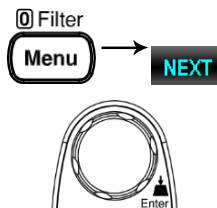

2. Press the F5 (Enter) key or Knob key to enter the Calibration menu.





Frequency Calibration

Frequency Compensate (1.000017) Enable or disable frequency compensation (the value indicates the compensation coefficient; default: Factory calibration value)

Check the box to enable:

$$\text{Frequency} = \text{Original Frequency} \times \text{Compensate Coefficient}$$

Uncheck the box to disable:

$$\text{Frequency} = \text{Original Frequency}$$

FREQ Cali Method

Select either Auto or Manual frequency cali method. When Manual is opted, input a frequency compensation coefficient directly.

1. Select Manual mode.





2. Input a compensation coefficient.



3. Use the Left/Right keys to move the cursor followed by pressing the F5 (Enter) key to save the frequency compensation coefficient. The value changes as the figure shown below.



Please Input Start the frequency compensation  
1kHz Source coefficient calculation and connect the  
1k Hz standard source to the Input HI  
and LO terminals (only available  
when Auto mode is opted).





Note

Please regard the 1k Hz standard source as the baseline for frequency compensation coefficient calculation. The accuracy of value after compensation is relevant to the connected 1k Hz standard source. For instance, if the accuracy of 1k Hz standard source is  $\pm 5\text{ppm}$ , the value after compensation will be  $\pm 5\text{ppm}$  plus the accuracy of  $\pm 1\text{ppm}$ .

DC Gain  
Calibration

DC Gain  
Calibration

Click "Start" to execute DC Gain Calibration, which is an internally self-calibration function that does Not require external signal source. It corrects the gain of internal amplifier, though it is not necessary for general conditions unless the significant change in the gain of internal amplifier. It is suggested performing this calibration one time monthly.

DMM Calibration

DMM  
Password

Input the password into the field.  
Default: 12345678

DMM Start  
Calibration

Click "Start" to perform the DMM Calibration.



Note

The calibration procedure can be only executed by the certified technician in accordance with the standard instruments. Refer to the qualified personnel for details.

## Firmware Update

**Background** This section is for updating the latest firmware.

**Step**

1. Press the Menu key, the System configuration menu appears. And press the NEXT key repeatedly or scroll the Knob key to move to the Cali&Update - Firmware field.

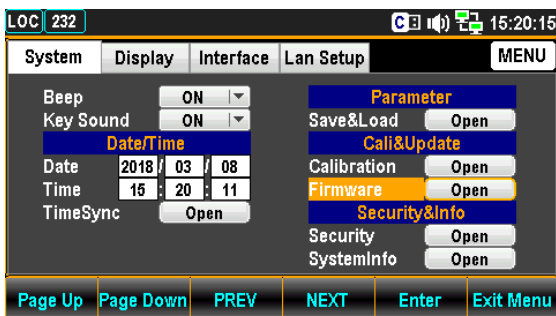
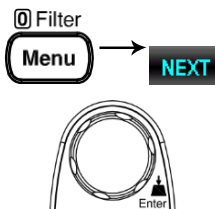

2. Press the F5 (Enter) key or Knob key to enter the Firmware Update menu.



## Firmware Update Process

Prior to update, make sure if the required firmware file is stored within the flash drive plugged into the USB port on the front panel. Also, user can check the current Master and Slave firmware version respectively in this menu.

1. Press the F5 (Enter) key or Knob key first, the qualified firmware version will show then.



Note: If flash drive has no update files, it will show as the figure below.



2. Press the NEXT key or scroll Knob key to move to the Update followed by pressing the F5 (Enter) key or Knob key to Start update.



## Security Setting

**Background** This section is to change the password and enable or disable Lan password.

- Step**
1. Press the Menu key, the System configuration menu appears. And press the NEXT key repeatedly or scroll the Knob key to move to the Security&Info - Security field.

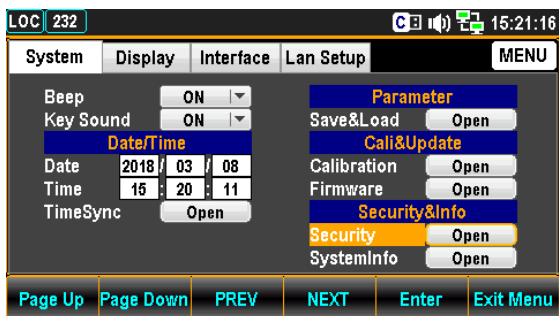

- Press the F5 (Enter) key or Knob key to enter the Please Input Password page.

**Enter**

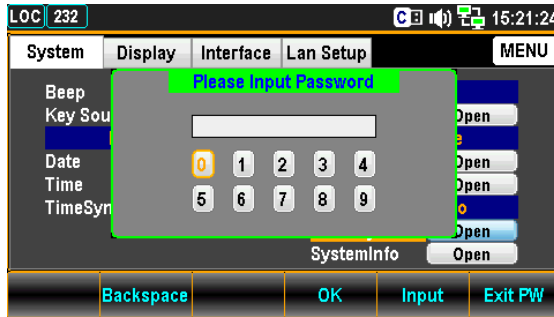

- Use the Left/Right and +/- keys or scroll the Knob key to move the cursor followed by pressing the F5 (Input) key or the Knob key to input the password.

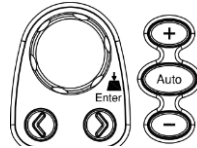

**Input**

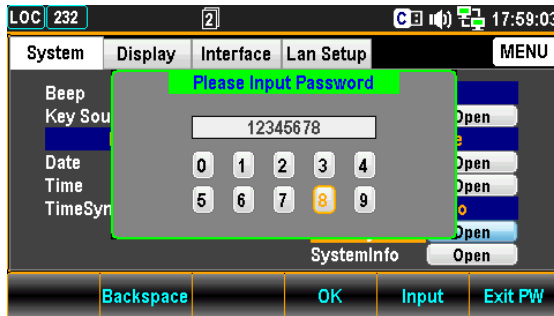

- Press the F4 (OK) key or Knob key to enter the Security page.

**OK**

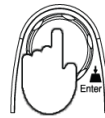



Security	Lan Password Enable	Enable or disable password requirement for Lan web and telnet Control. Check / Uncheck
	Old Password	Enter the old password
	New Password	Enter the new password
	Confirm Password	Enter the new password again
	Modify Password	Change password by clicking Start

## View System Info

Background	View system information including Vendor, Model Name, Serial Number, Master Firmware and Slave Firmware.
------------	--

- Step
1. Press the Menu key, the System configuration menu appears. And press the NEXT key repeatedly or scroll the Knob key to move to the Security&Info - SystemInfo field.

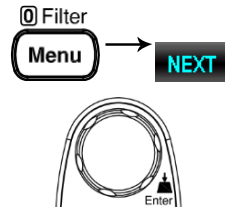

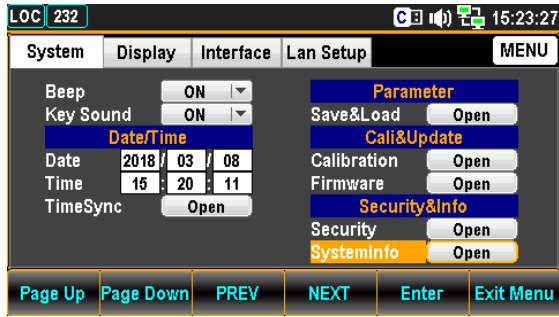

2. Press the F5 (Enter) key or Knob key to enter the System Information where all the critical contents are exposed for check.

**Enter**





# Configure Display

## Brightness Setting

Background      Backlight brightness adjustment

Step

1. Press the Menu key followed by pressing the Page Down key repeatedly until the Display configuration menu appears.

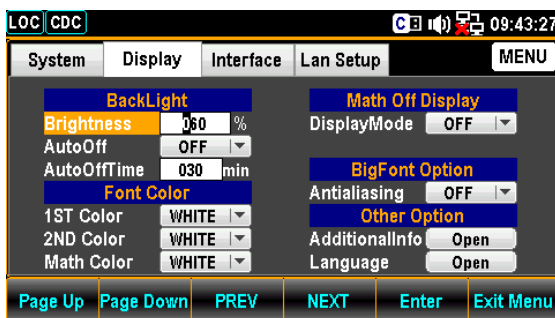

2. Use the Left/Right keys to move the cursor followed by scrolling Knob key or pressing +/- keys to define digit. Also, you can press Number keys to directly input a specific digit.

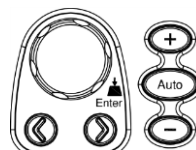

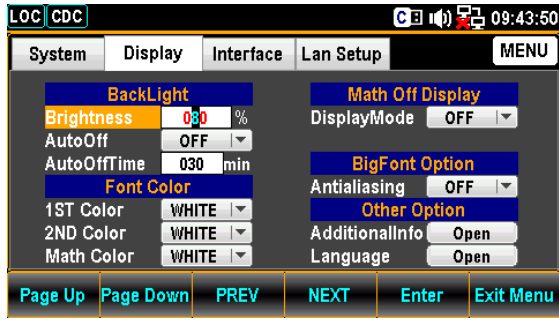

3. Press the F5 (Enter) key or Knob key to confirm the input digit for backlight brightness.

**Enter**



## Auto Off Setting

**Background** Enable or disable automatic brightness adjustment

**Step**

1. Press the Menu key followed by pressing the Page Down key repeatedly until the Display configuration menu appears.

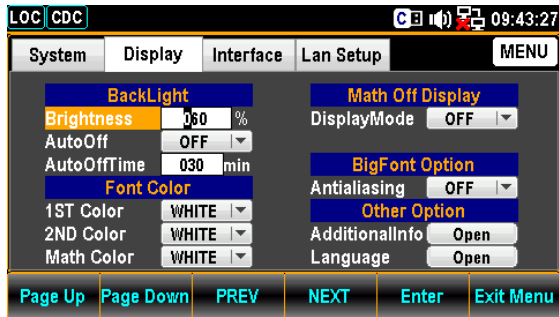

- Press the NEXT key repeatedly or scroll the Knob key to move to the BackLight - AutoOff field.

**NEXT**

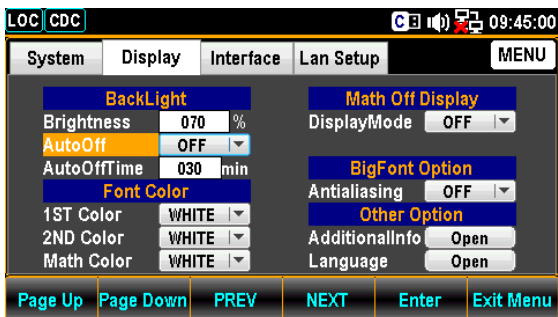
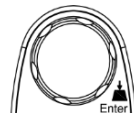

- Press the F5 (Enter) key or Knob key followed by scrolling Knob key or pressing +/- keys to select the ON option.

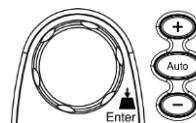

**Enter**

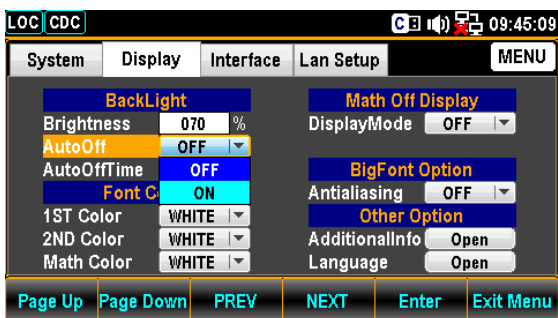

- Press the F5 (Enter) key or Knob key to confirm the ON option for AutoOff.

**Enter**

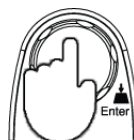

## Auto Off Time Setting

**Background** Set the duration before automatic brightness adjustment. When the machine has been idle for the set duration, the screen will change to automatic brightness adjustment.





**Note**

Auto Off Time will be activated only when Auto Off option is turned ON.

**Step**

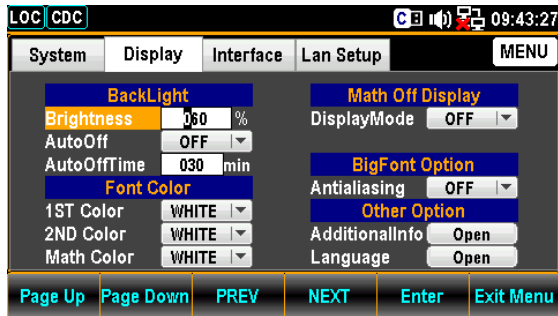
1. Press the Menu key followed by pressing the Page Down key repeatedly until the Display configuration menu appears.
 



2. Press the NEXT key repeatedly or scroll the Knob key to move to the BackLight - AutoOffTime field.
 

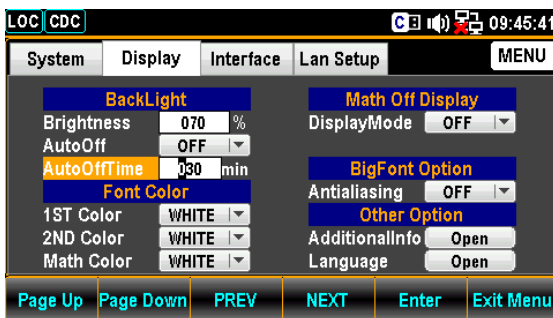

3. Use the Left/Right keys to move the cursor followed by scrolling Knob key or pressing +/- keys to define minutes. Also, you can press Number keys to directly input a specific minutes.

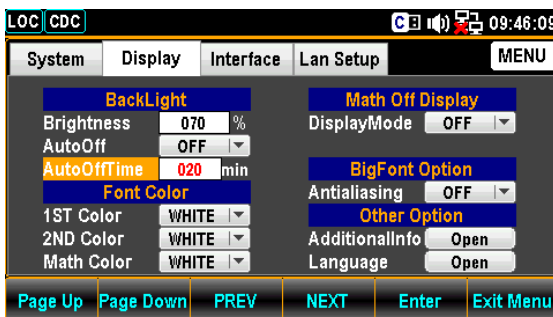
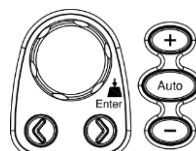

4. Press the F5 (Enter) key or Knob key to confirm the input minutes for Auto Off Time.

**Enter**



# 1ST Color Setting

Background Set the theme color of 1ST display

Step

1. Press the Menu key followed by pressing the Page Down key repeatedly until the Display configuration menu appears.

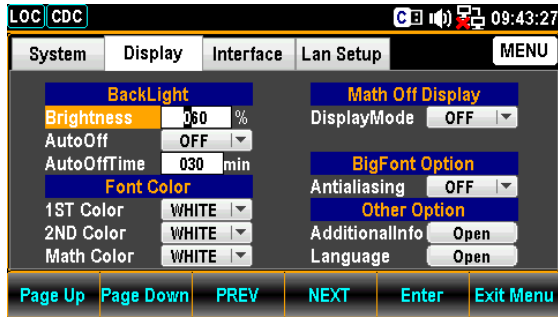

2. Press the NEXT key repeatedly or scroll the Knob key to move to the Font Color - 1ST Color field.

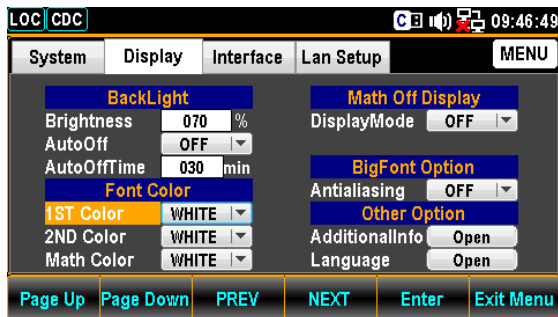
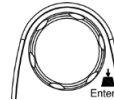

- Press the F5 (Enter) key or Knob key followed by scrolling Knob key or pressing +/- keys to select desired color for 1ST display.

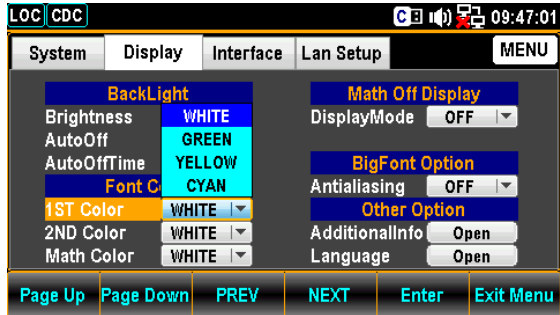
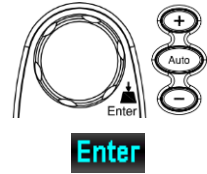

- Press the F5 (Enter) key or Knob key to confirm the selected color.



Display result

The following figure demonstrates the defined yellow color for 1ST display.

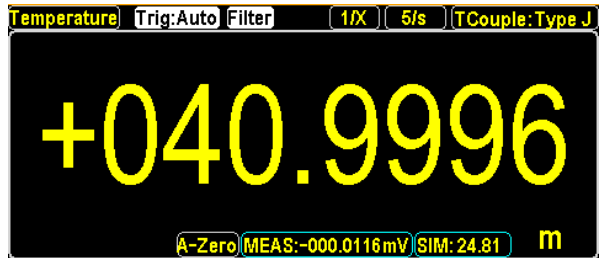



## 2ND Color Setting

**Background** Set the theme color of 2ND display

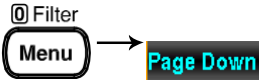
**Step**

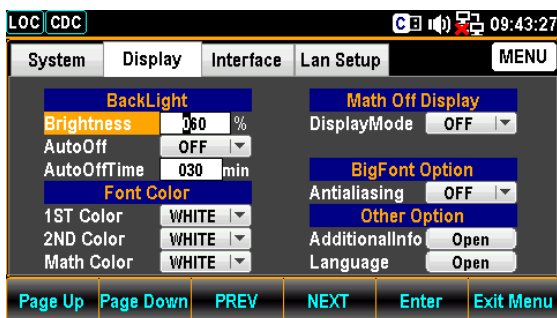
1. Press the Menu key followed by pressing the Page Down key repeatedly until the Display configuration menu appears.
 



2. Press the NEXT key repeatedly or scroll the Knob key to move to the Font Color – 2ND Color field.
 

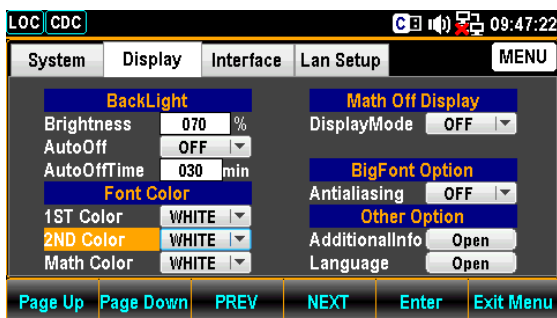



- Press the F5 (Enter) key or Knob key followed by scrolling Knob key or pressing +/- keys to select desired color for 2ND display.

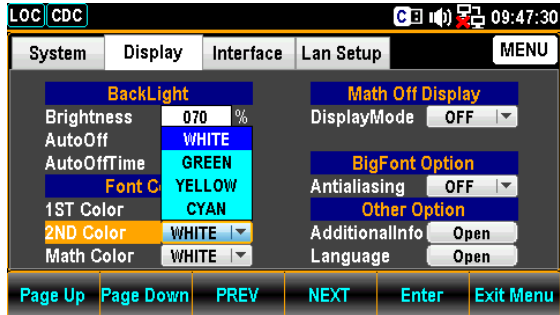
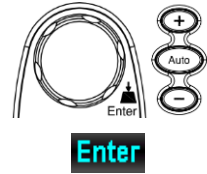

- Press the F5 (Enter) key or Knob key to confirm the selected color.



Display result

The following figure demonstrates the defined green color for 2ND display.



## Math Color Setting

**Background** Set the theme color of Math functions

- Step**
1. Press the Menu key followed by pressing the Page Down key repeatedly until the Display configuration menu appears.

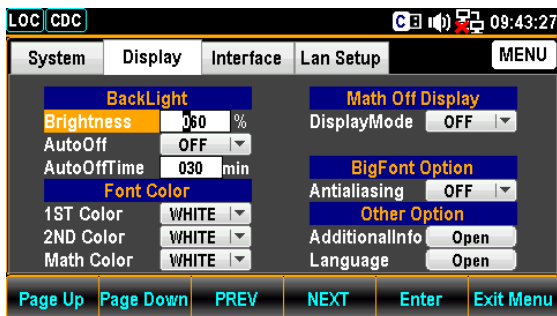

2. Press the NEXT key repeatedly or scroll the Knob key to move to the Font Color – Math Color field.

**NEXT**

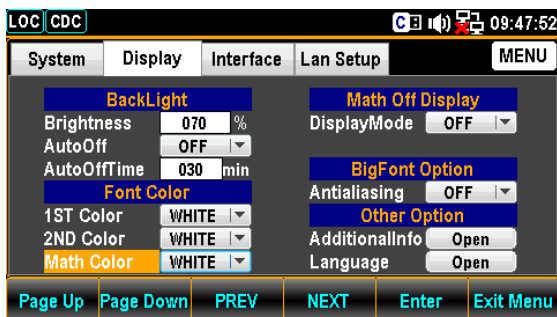
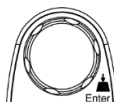

- Press the F5 (Enter) key or Knob key followed by scrolling Knob key or pressing +/- keys to select desired color for Math display.

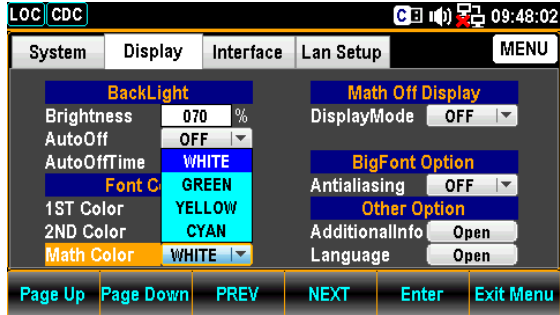
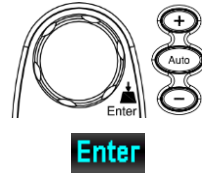

- Press the F5 (Enter) key or Knob key to confirm the selected color.



Display result

The following figure demonstrates the defined cyan color for Math display.

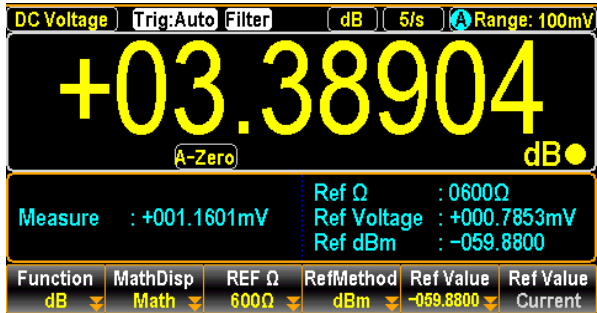

## Display Mode Setting

**Background** Enable or disable if time info or user-defined text is shown in the 1ST display only when MathDisp is off.

- Step**
1. Press the Menu key followed by pressing the Page Down key repeatedly until the Display configuration menu appears.

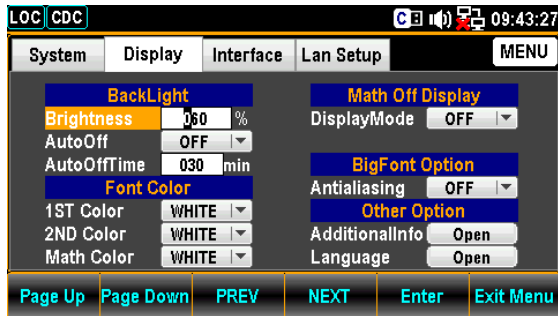

2. Press the NEXT key repeatedly or scroll the Knob key to move to the Math Off Display - DisplayMode field.

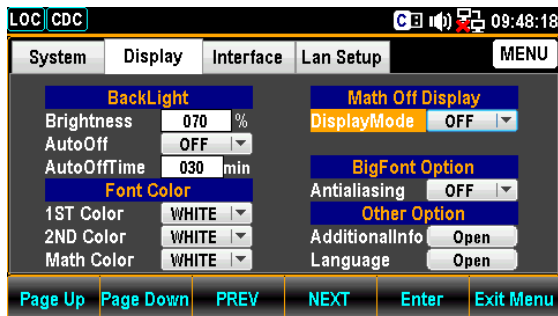

## Time display

1. Press the F5 (Enter) key or Knob key followed by scrolling Knob key or pressing +/- keys to select the Time option.

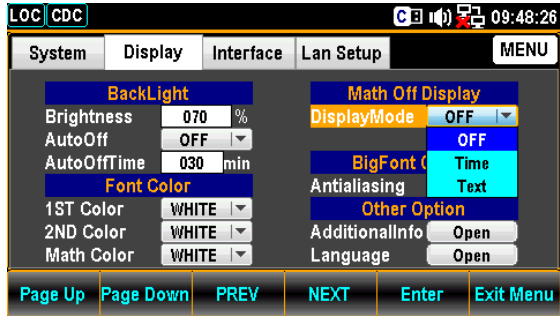
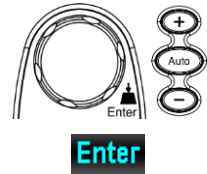

2. Press the F5 (Enter) key or Knob key to confirm the Time option.

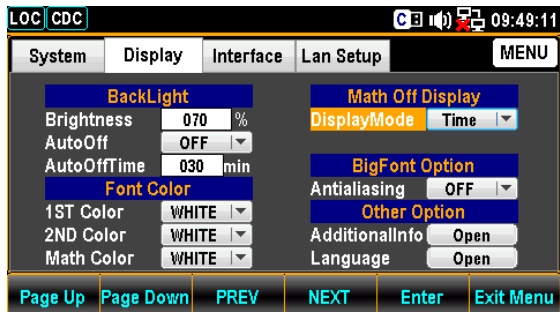
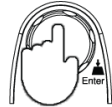

## Display result

The following figure demonstrates the time info shown in the 1ST display.

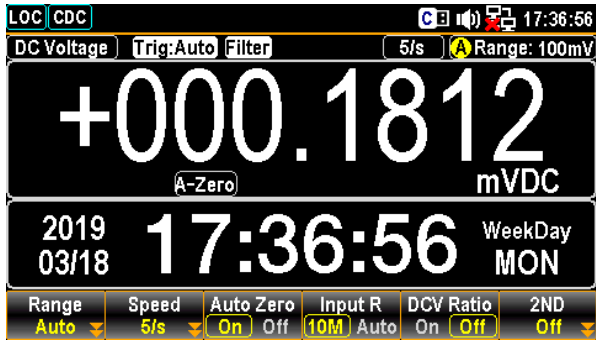

Text display

1. Press the F5 (Enter) key or Knob key followed by scrolling Knob key or pressing +/- keys to select the Text option.

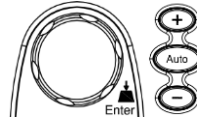

Enter

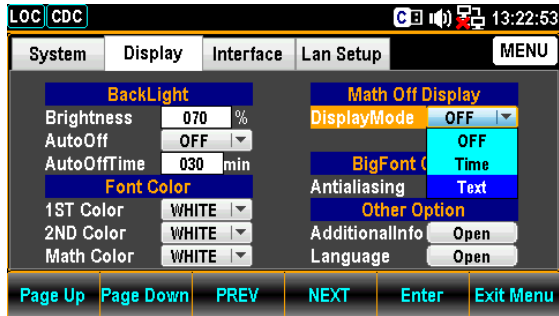

2. Press the F5 (Enter) key or Knob key to confirm the Text option.

Enter



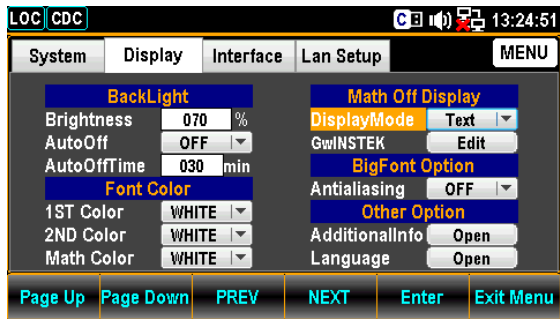

3. Press the NEXT key or scroll the Knob key to move to the Math Off Display - Edit field.

NEXT

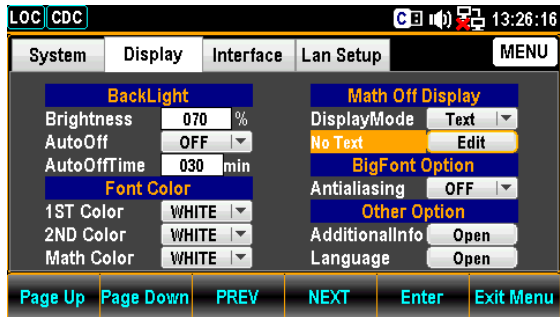
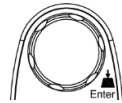

4. Press the F5 (Enter) key or Knob key to enter the KeyBoard page.

Enter

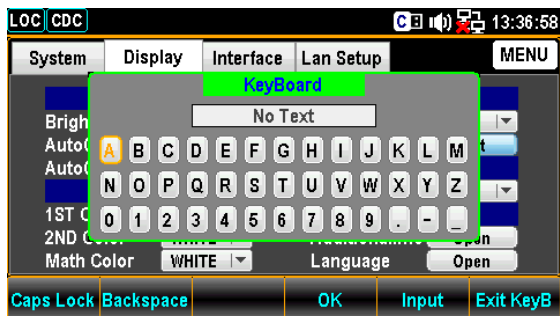
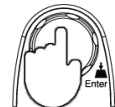

- Press Backspace to clear default text first. Use the Left/Right & +/- keys or scroll the Knob key to move the cursor followed by pressing the F5 (Input) key or Knob key to input desired words.

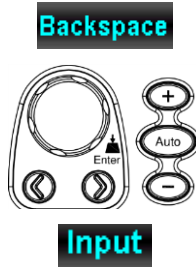

Note: F1 (Caps Lock) key is for high and low case shift.

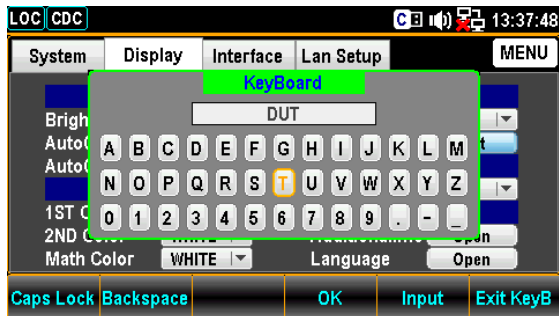

- Press the F4 (OK) key to confirm the input words.

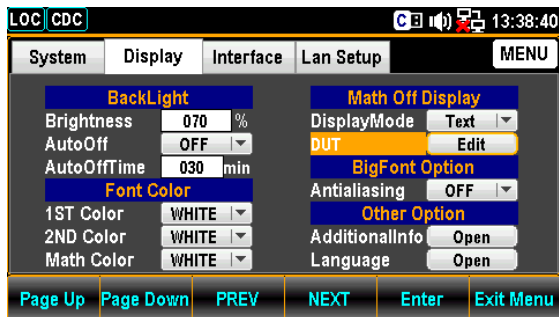

Display result

The following figure demonstrates the defined text shown in the 1ST display.



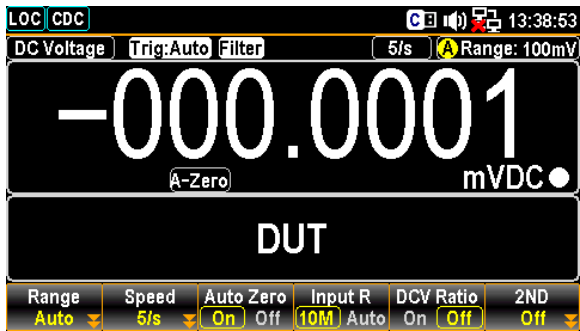

## Anti Aliasing Setting

**Background** Enable or disable the anti-aliasing function, which facilitates the display of measured value much smoother and easy-readable. Note that this function is available for up to 1.2k/s refresh rate. The 2.4k/s above refresh rates are Not supported by anti-aliasing.



Note

When Auto Zero or dual measure mode, both of which lower down computing speed, is activated, anti-aliasing function can support up to the maximum 10k/s refresh rate.

Step

1. Press the Menu key followed by pressing the Page Down key repeatedly until the Display configuration menu appears.

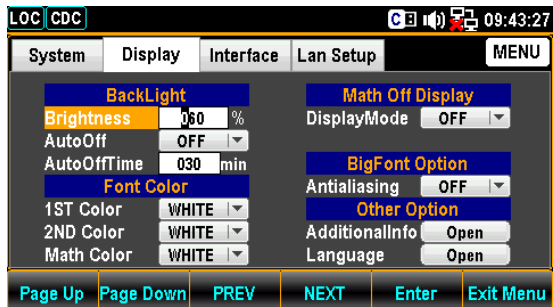

- Press the NEXT key repeatedly or scroll the Knob key to move to the BigFont Option – Antialiasing field.

NEXT

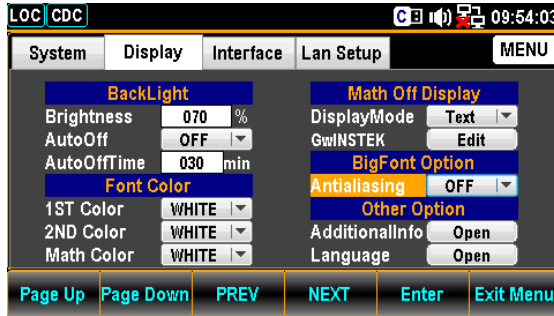

- Press the F5 (Enter) key or Knob key followed by scrolling Knob key or pressing +/- keys to select the ON option.

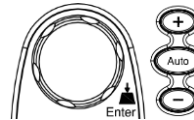

Enter

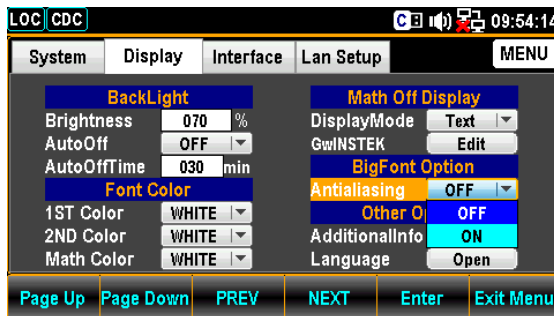

- Press the F5 (Enter) key or Knob key to confirm the ON selection.

Enter



## Additional Info Setting

Background      Enable or disable the additional information display.

Step

1. Press the Menu key followed by pressing the Page Down key repeatedly until the Display configuration menu appears.

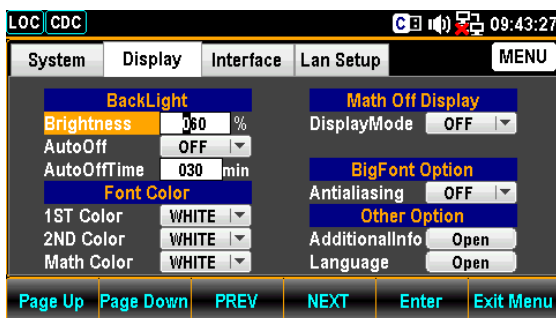

2. Press the NEXT key repeatedly or scroll the Knob key to move to the Other Option - AdditionalInfo field.

**NEXT**

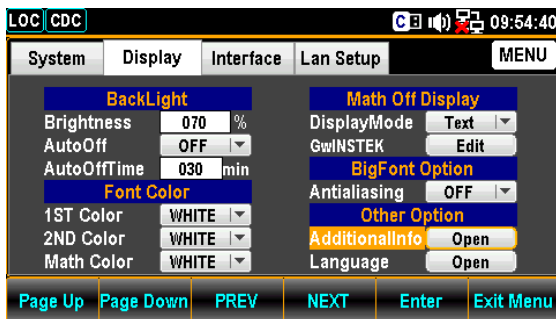
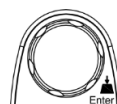

- Press the F5 (Enter) key or Knob key to enter the Additional menu. Press the Next key or scroll the Knob key followed by pushing the F5 (Enter) key or Knob key to enable/disable each option. Move to the Return option followed by pressing the F5 (Enter) key or Knob key to have the setting take effect.

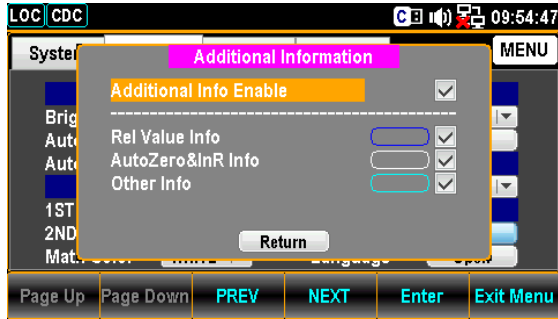
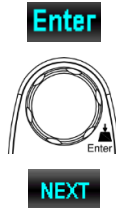

Display result

Take the Temperature mode for example as the figure below, we can clearly recognize the colors with info as follows.

- Rel Value Info is outlined by blue frame.
- Auto Zero Info is outlined by white frame.
- Additional (SIM) Info is outlined by cyan frame.

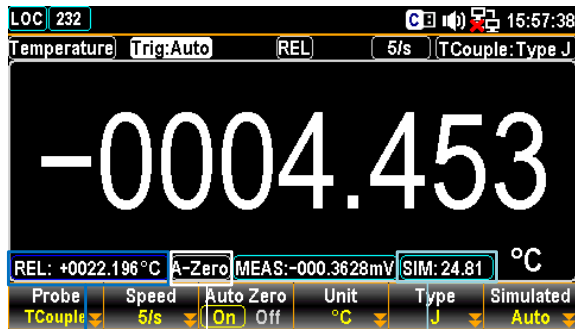

REL Info      Auto Zero Info      SIM Info  
(Additional Info)

# Language Setting

Background      Select language for user interface display.

Step

1. Press the Menu key followed by pressing the Page Down key repeatedly until the Display configuration menu appears.

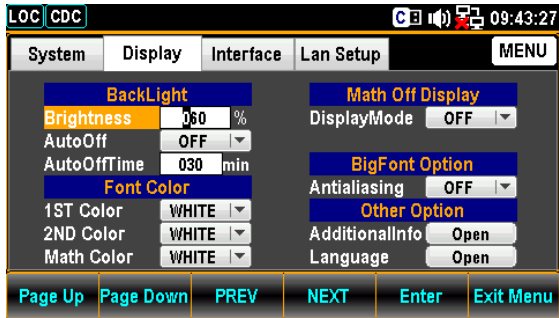
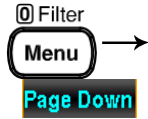

2. Press the NEXT key repeatedly or scroll the Knob key to move to the Other Option – Language field.

**NEXT**

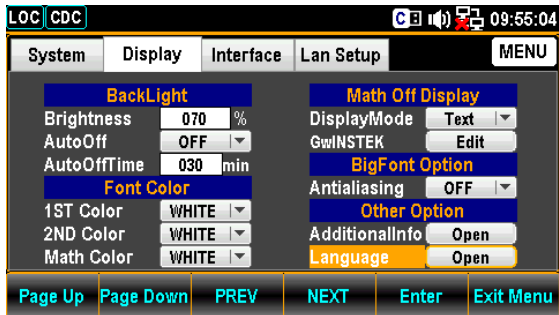
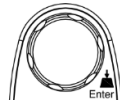

- Press the F5 (Enter) key or Knob key to enter the Language menu. Press the Next key or scroll the Knob key followed by pushing the F5 (Enter) key or Knob key to select one of the language options. Move to the Return option followed by pressing the F5 (Enter) key or Knob key to have the setting take effect.

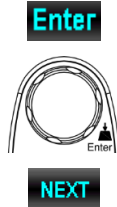

Options    English

繁體中文 (Traditional Chinese)

简体中文 (Simplified Chinese)

日本語 (Japanese)

한국어 (Korean)



Note

When “日本語” is checked, only prompt message will be shown in Japanese. The user interface still remains in full English display. See the figure below.



# SCREENHOT & LOG

---

Capture .....	212
Save Reading.....	215



# Capture

## Background

Configure the mode of screenshot capturing.

Supported USB Sticks:

USB Disk Type: Flash Disk Only

FAT Format: Fat16 or Fat32(Recommended)

Max memory size: 128GB



## Note

Flash disks which need to use card adaptors are not recommended to be used in this application.

## Step

1. Press the Shift key followed by the LOG/LOG# key and the following menu appears.

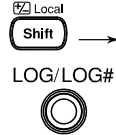

2. Press the F1 (Log Mode) key followed by clicking the F1 (Capture) key to enable the Capture mode for screenshot.

**Log Mode**

**Capture**



3. Press the F2 (FileName) key to enter the Log FileName Mode menu. Further press the F1 (Default) key to let system saves screenshot by auto name in serial number or press the F2 (Manual) key to determine file name by user.

**FileName**

**Default**

**Manual**



Number Range      The auto name in serial number ranges from SCREEN00 to SCREEN99.

Number Zero      Replugging the USB disk will zero the serial number to the initial.





Note

When the serial number reaches the maximum, e.g., SCREEN99, the save action will be Not available.

- Press the F3 (EditName) key to enter the KeyBoard page where user can press the F2 (Backspace) key to clear default text. Use the Left/Right & +/- keys or scroll the Knob key to move the cursor followed by pressing the F5 (Input) key or Knob key to input desired words. The F1 (Caps Lock) key is for high and low case shift.

**EditName**

**Backspace**

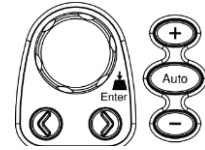

**Input**

**Caps Lock**



- Press the F4 (OK) key to confirm the input words.

**OK**



Note

It is only available when “Manual” is selected for Log FileName Mode.

- Press the F4 (OverWrite) key to enter the Log OverWrite Mode menu where user can press the F1 (Always) key to automatically overwrite filename when saving or press the F2 (Query) key to let system query first before saving.

**OverWrite**

**Always**

**Query**





Note

---

#### For File Name - Default

- Under Overwrite - “Always mode”, when replugging the USB disk, the serial number will be zeroed to the initial and the existed file in the USB disk will be overwritten automatically when saving.
- Under Overwrite - “Query mode”, when replugging the USB disk, the serial number will be zeroed to the initial and a prompt message asks, when saving, if to overwrite the existed file, click F1 (Yes) to overwrite, whilst click F2 (No) to save in a non-occupied serial number of file name. Click ESC key to simply discard the overwrite action.

#### For File Name - Manual

- Under Overwrite - “Always mode”, when replugging the USB disk, the file to save will overwrite the existed file in the USB disk by the user-editted name.
  - Under Overwrite - “Query mode”, when replugging the USB disk, a prompt message asks if to overwrite the existed file, click F1 (Yes) to overwrite, whilst click F2 (No) to bring out the KeyBoard page to reedit a file name to save. Click ESC key to simply discard the overwrite action.
-

# Save Reading

**Background** Configure the mode of data log saving.

**Step**

1. Press the Shift key followed by the LOG/LOG# key and the following menu appears.

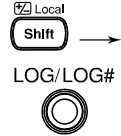

2. Press the F1 (Log Mode) key followed by clicking the F2 (SaveRead) key to enable the Save and Read mode for data log.

**Log Mode**

**SaveRead**



3. Press the F2 (FileName) key to enter the Log FileName Mode menu. Further press the F1 (Default) key to let system saves screenshot by auto name in serial number or press the F2 (Manual) key to determine file name by user.

**FileName**

**Default**

**Manual**



**Number Range** For Count Source

- The auto name in serial number ranges from DATAC000 to DATAC999.

For Recent Source

- The auto name in serial number ranges from DATAR000 to DATAR999.

**Number Zero** Replugging the USB disk will zero the serial number to the initial.



Note

When the serial number reaches the maximum, e.g., DATAC999, the save action will be Not available.

- Press the F3 (EditName) key to enter the KeyBoard page where user can press the F2 (Backspace) key to clear default text. Use the Left/Right & +/- keys or scroll the Knob key to move the cursor followed by pressing the F5 (Input) key or Knob key to input desired words. The F1 (Caps Lock) key is for high and low case shift.

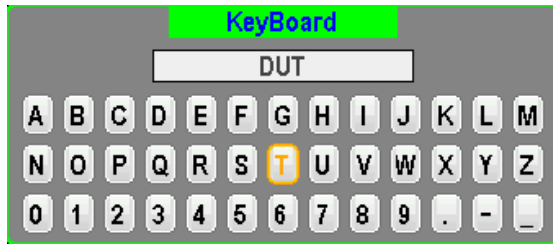
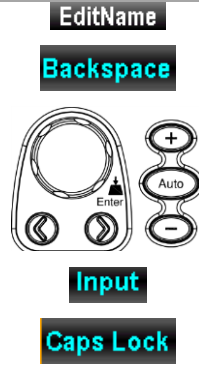

- Press the F4 (OK) key to confirm the input words.

**OK**

Note

It is only available when Manual is selected for Log FileName Mode.

- Press the F4 (OverWrite) key to enter the Log OverWrite Mode menu where user can press the F1 (Always) key to automatically overwrite filename when saving or press the F2 (Query) key to let system query first before saving.

**OverWrite**

**Always  
Query**





Note

#### For File Name - Default

- Under Overwrite - “Always mode”, when replugging the USB disk, the serial number will be zeroed to the initial and the existed file in the USB disk will be overwritten automatically when saving.
- Under Overwrite - “Query mode”, when replugging the USB disk, the serial number will be zeroed to the initial and a prompt message asks, when saving, if to overwrite the existed file, click F1 (Yes) to overwrite, whilst click F2 (No) to save in a non-occupied serial number of file name. Click ESC key to simply discard the overwrite action.

#### For File Name - Manual

- Under Overwrite - “Always mode”, when replugging the USB disk, the file to save will overwrite the existed file in the USB disk by the user-editted name.
- Under Overwrite - “Query mode”, when replugging the USB disk, a prompt message asks if to overwrite the existed file, click F1 (Yes) to overwrite, whilst click F2 (No) to bring out the KeyBoard page to reedit a file name to save. Click ESC key to simply discard the overwrite action.

- 
7. Press the F5 (Source) key to enter **Source** the SaveRead Source(Log) menu where user can select either source to save and read. Determine the source mode by further pressing the F1 (Count) key or the F2 (Recent) key. “Count” indicates the **Count** saved data log contains the total counts of measurement, whilst “Recent” represents each count of measurement has user-defined interval in the saved data log. For details, refer to page 54. **Recent**



# DISPLAY SETTING

---

Digit.....	220
Display.....	222
Number.....	222
Bar Meter .....	223
Trend Chart .....	227
Histogram .....	238



# Digit

**Background** Define the maximum digit numbers for each measurement.

- Step**
1. Press DISP key followed by clicking the F1 (Digit) key, the Digit menu appears where several digit options are available to select.



2. Further press F1 (6 1/2), F2 (5 1/2), F3 (4 1/2) keys for desired maximum digit numbers on display, or press the F1 (Auto) key to allow system determine digit numbers for display per measuring situation.



## Digit Parameter Display

6 1/2

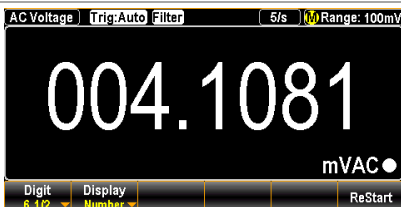

5 1/2

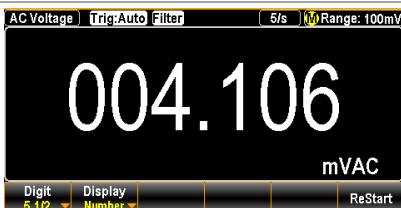

4 1/2

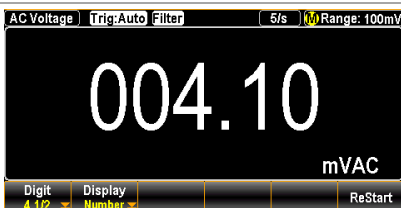



Auto

The maximum digit numbers may vary in accord with the applied measuring functions and refresh rates.

The correlation between measure types and speeds for available digit numbers

Speed Measure Type	1/s	2/s	5/s	20/s	60/s	100/s	400/s	1k/s	1.2k/s	2.4k/s	4.8k/s	7.2k/s	10k/s
DCV	-	-	6 1/2	6 1/2	6 1/2	6 1/2	5 1/2	5 1/2	5 1/2	5 1/2	4 1/2	4 1/2	4 1/2
ACV	6 1/2	-	5 1/2	4 1/2	-	-	-	-	-	-	-	-	-
DCI	-	-	6 1/2	6 1/2	6 1/2	6 1/2	5 1/2	5 1/2	5 1/2	5 1/2	4 1/2	4 1/2	4 1/2
ACI	6 1/2	-	5 1/2	4 1/2	-	-	-	-	-	-	-	-	-
2W/4W	-	-	6 1/2	6 1/2	6 1/2	6 1/2	5 1/2	5 1/2	5 1/2	5 1/2	4 1/2	4 1/2	4 1/2
Continuity	-	-	-	-	6 1/2	5 1/2	4 1/2	-	-	-	-	-	-
Diode	-	-	-	-	6 1/2	5 1/2	4 1/2	-	-	-	-	-	-
Temp	-	-	6 1/2	5 1/2	4 1/2	-	-	-	-	-	-	-	-
Cap	-	4 1/2	-	-	-	-	-	-	-	-	-	-	-



Note

■ is applicable to RSDM-9060, whilst ■ is specifically for RSDM-9061.

The correlation between frequency/period and gate time for available digit numbers

Measure Type	Gate Time		
	1/s	100ms	10ms
Frequency/Period	6 1/2	5 1/2	4 1/2

# Display

## Number

**Background** Shift to the Number display mode for each measurement.

**Step** 1. Press the DISP key followed by clicking the F2 (Display) key, the Display menu appears where several display options are available for selection.



2. Press the F1 (Number) key, the screen shows the Number mode for measurement display. The measured value is presented in the clear number way for viewing, along with the maximum digits display depending on the Digit selection.



Display

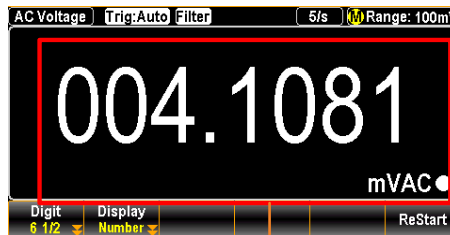

Measured value presented in Number

## Bar Meter

**Background** Shift to the Bar Meter display for each measurement.

**Step** 1. Press the DISP key followed by clicking the F2 (Display) key, the Display menu appears where several display options are available for selection.



**Digit**



2. Press the F2 (Bar Meter) key, the screen shows the Bar Meter mode for measurement display. The measured value is presented in the bar meter way for viewing, along with the maximum digits display depending on the Digit selection.

**Bar Meter**

**Display**

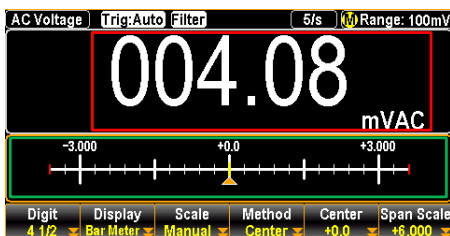

**Red Sect.** It indicates the currently measured value in number display.

**Green Sect.** It indicates the currently measured value in bar meter display.

**Background** Press the F3 (Scale) key to enter the Scale Mode menu where Normal and Manual options are available for selection.



F3 (Scale) key to decide scale mode Background Press the F3 (Scale) key to enter the Scale Mode menu where Normal and Manual options are available for selection.

Normal Selecting “Normal” allows the scale of meter bar to be symmetric with the selected range of measurement.

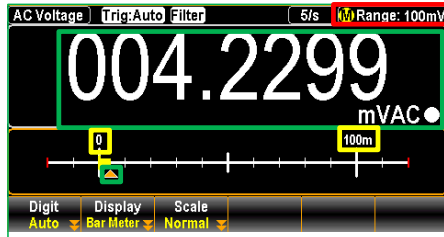

Red Sect. The user-specified range for measurement.

Yellow Sect. The endpoints of 2 sides are “0” and “100m” respectively, which perfectly correspond to the specified range of measurement.

Green Sect. The currently measured value.

Manual Selecting “Manual” allows user to customize the available scale for meter bar on display.

F4 (Method) key to decide Method mode Background When user selects “Manual” option under the F3 (Scale) key, the Method can be further defined here for varied applications.

LowHigh When LowHigh is selected, it is available to further determine the exact scales for both the high and low ends on the bar meter display.

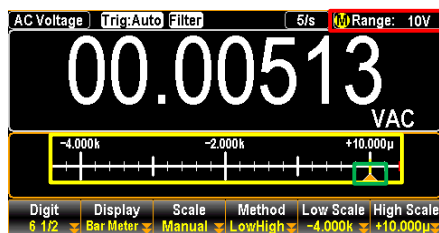

Yellow Sect. The available scale of bar meter starts from the lowest (-4.000k) to the highest (+10.000µ), which are defined by user individually.

Red Sect. The user-specified range for measurement.

Green Sect. The currently measured value.

Center When Center is selected, it is available to further determine the exact Center value and the Span Scale for the meter bar display.

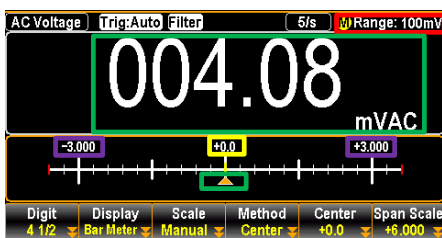

Yellow Sect. The Center value defined by user.

Purple Sect. The Span Scale defined by user.

Red Sect. The user-specified range for measurement.



Green Sect. The currently measured value.

F5 (Low Scale) & F6 (High Scale) keys After user selects “LowHigh” option under the F4 (Method) key, the low and high scales can be specified individually via F5 (Low Scale) & F6 (High Scale) keys.

Display

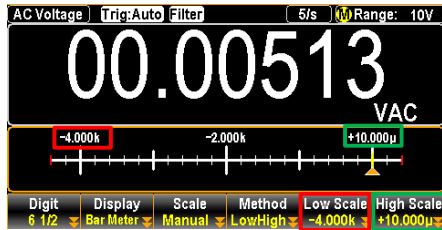

Red Sect. The specified Low Scale (-4.000k) in F5 key is identical with the upper value in red frame on the low scale of meter bar.

Green Sect. The specified High Scale (+10.000µ) in F6 key is identical with the upper value in green frame on high scale of meter bar.

F5 (Center) & F6 (Span Scale) keys When Center method is opted, user can further determine the Center and Span Scale individually via F5 (Center) & F6 (Span Scale) keys.

Display

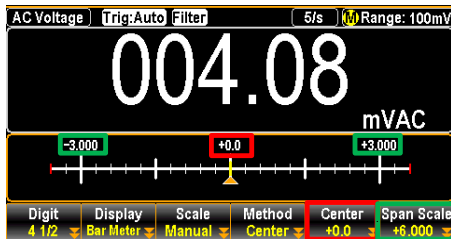

Red Sect. The specified Center (+0.0) in F5 key is identical with the upper value in red frame

on the center value of meter bar.

Green Sect. The specified Span Scale (+6.000) in F6 key indicates the whole scale of the meter bar, which means +6.000 will be evenly divided into 2 ends of the meter bar that results in -3.000 in the left end and +3.000 in the right end as the figure shown.

## Trend Chart

Background Shift to the Trend Chart display for each measurement.

Step

1. Press the DISP key followed by clicking the F2 (Display) key, the Display menu appears where several display options are available for selection.



Digit



2. Press the F3 (TrendChart) key, the screen shows the Trend Chart mode for measurement display. The measured value is presented in the trend chart way for viewing, along with the maximum digits display depending on the Digit selection.

TrendChart

Display

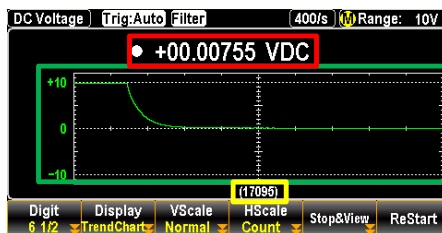

---

Red Sect. It indicates the currently measured value in number display.

---

Green Sect. It indicates the latest measurements of 400 counts in the intuitive trend chart.

---

Yellow Sect. The total counts of measurement with the maximum of 100,000. Only 400 counts, however, can be displayed in the trend chart at once.

---

F3 (VScale) key to Background define vertical scale Press the F3 (Scale) key to enter the VScale Setup menu where Normal and Manual options are available for selection.

---

Normal Selecting “Normal” allows the vertical scale of trend chart to be symmetric with the selected range of measurement.

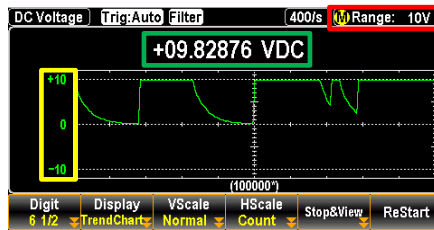

Red Sect. The user-specified range for measurement.

---

Yellow Sect. The highest scale (+10) corresponds to the upper defined manual range 10V, and the lowest scale is the relative value in the opposite spectrum.

---

Green Sect. The currently measured

---



Manual

Sect. value.

Selecting “Manual” allows user to customize the available scale for trend chart on display.

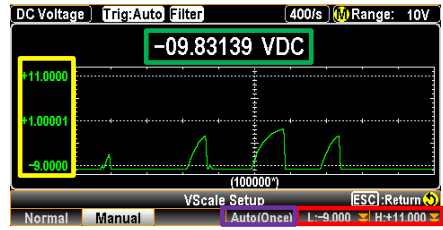

Red Sect. The user-specified highest and lowest scales. Press the F5 and F6 keys to set up individually.

Yellow Sect. Both the highest scale (+11.0000) and the lowest scale (-9.0000) correspond to the user-specified values in the red section.

Green Sect. The currently measured value.

Purple Sect. Press the F4 (Auto(Once)) key to obtain the highest and lowest scales from the latest 400 counts of measurements into the trend chart as a baseline of vertical scale. Take the figure below for instance, the highest and lowest ends in vertical scale are irregular values 20.573m and -9.8303 which come from the latest measurements.

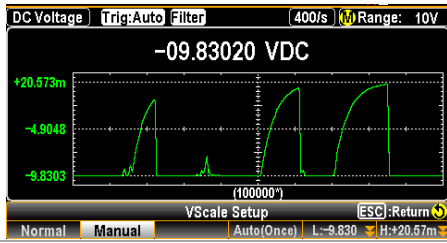

F4 (HScale) key to Background define horizontal scale

Press the F4 (HScale) key to enter the HScale Setup menu where Count and Recent options are available for selection.

Count

Selecting “Count” allows the horizontal scale of trend chart to be symmetric with the defined refresh rate of measurement.

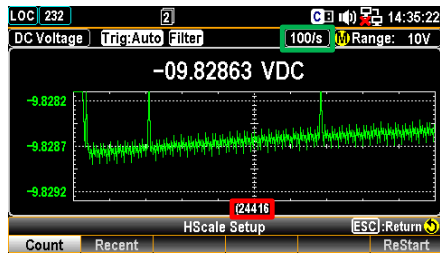

Green Sect.

The user-defined refresh rate.

Red Sect. The refreshing frequency of the total counts of measurements is consistent with the refresh rate. For example, setting 10k/s results in the fastest frequency, while 1s leading to the slowest frequency.

Recent

Selecting “Recent” allows the horizontal scale of trend chart to be customized by user.

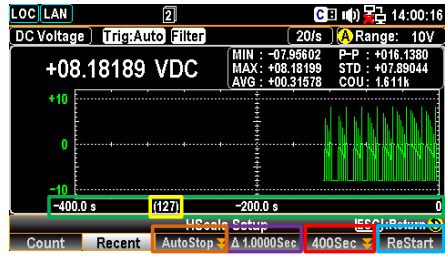

**Red Sect.** The user-specified range of horizontal scale in the unit of second. Press the F5 key to set up individually.

**Green Sect.** The horizontal scale ranging from the right-side 0 to the left-hand -400.0s that corresponds to the user-specified range of horizontal scale.

**Yellow Sect.** The currently total counts of measurement.

**Orange Sect.** The user-specified auto-stop feature of the F3 key, which automatically suspends recording after a course of time period defined by user from the field highlighted in red as follows.

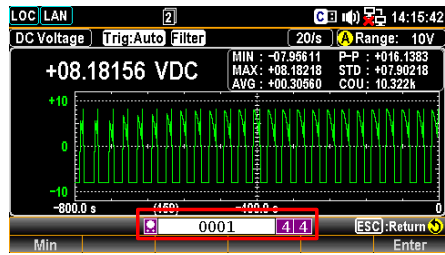

Value: 1~9999 Min



After confirming the time period for auto-stop, click “Start” in orange and the countdown appears on top of screen as the field highlighted in yellow below

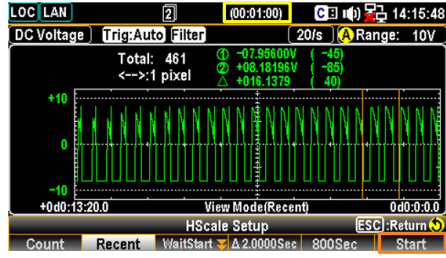

**Purple Sect.** The interval of each count of measurement which relates to the user-specified range of horizontal scale. To put it simply, due to the maximum 400 counts at once, when setting 400Sec, the interval is equal to 400Sec divided by 400 counts = 1 second. If setting 800Sec, it turns out  $800/400 = 2$  seconds.

**Blue Sect.** Press the F6 (Restart) key to recount the measurements.

**F5 (Stop&View) key for data** Press the F5 (Stop&View) key to enter the View Setup (Trend) mode which empowers user to have a detailed view into the measured data on the trend chart. Once clicking the key, measurement will stop right away.

## Display

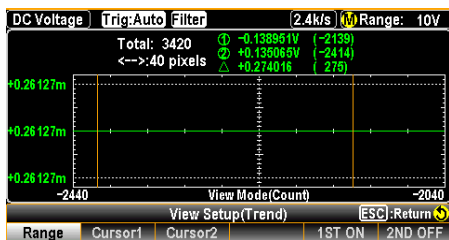

### F1 key (Range)

Press the F1 (Range) key to check a certain course of range of the measured counts. Scroll the Knob key rightward or leftward to move cursor on different sections.

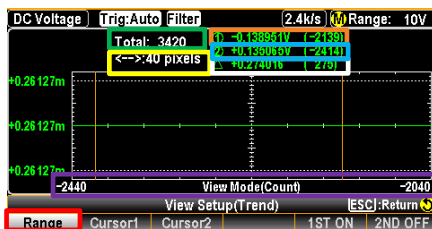

**Red Sect.** Press the F1 (Range) for range check.

**Green Sect.** The total counts of measurements before entering the Stop&View.

**Yellow Sect.** Press the Knob key to change the maximum counts for display.  
1 pixel – 4 pixels – 400 pixels

**Orange Sect.** The lowest value of the selected count with its affiliated serial number.

**Blue Sect.** The highest value of the selected count with its affiliated serial number.

White Sect. The delta between the highest and lowest values of the selected count with its affiliated serial number.

Purple Sect. The scale of measurements displayed, which relates to the yellow section – pixels. When 40 pixels are defined previously, scroll the Knob key once, the scale will increase or decrease 40 counts per time.

F2 key (Cursor1) Press the F2 (Cursor1) key to check the lowest value of each count. Scroll the Knob key rightward or leftward to move cursor on different sections.

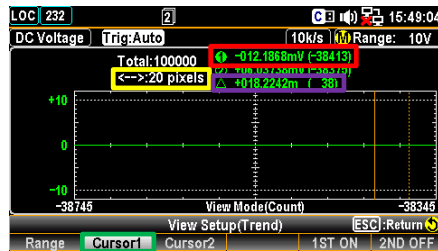

Green Sect. Press the F2 (Cursor1) for checking the lowest value of each count.

Red Sect. The lowest value of the selected count with its affiliated serial number.

Yellow Sect. Press the Knob key to change the maximum counts for display.

1 pixel – 10 pixels – 20 pixels

Purple Sect. The delta between the highest and lowest values

of the selected count with its affiliated serial number.

F3 key (Cursor2) Press the F3 (Cursor2) key to check the highest value of each count. Scroll the Knob key rightward or leftward to move cursor on different sections.

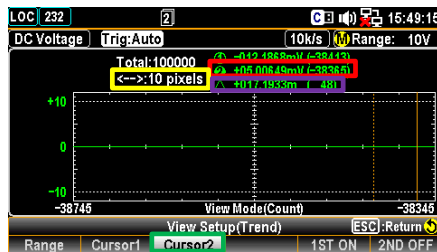

Green Sect. Press the F3 (Cursor2) for checking the highest value of each count.

Red Sect. The highest value of the selected count with its affiliated serial number.

Yellow Sect. Press the Knob key to change the maximum counts for display.  
1 pixel – 10 pixels – 20 pixels

Purple Sect. The delta between the highest and lowest values of the selected count with its affiliated serial number.

F4 key (COU/TIM)

**COU**

Press the F4 (COU/TIM) key to toggle between the 2 modes (COU/TIM). In association with the previous F1 (Range), F2 (Cursor1) and F3 (Cursor2) keys, user can utilize COU to check diversified values of each count per needs



Note

This option is only available when “Recent” under HScale is selected.

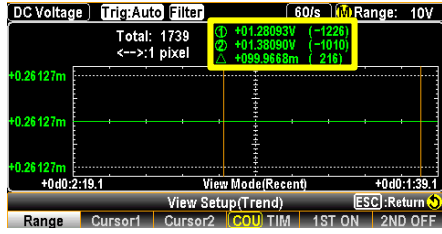

Yellow Sect. The display basically is identical with the previous introductions of F1 (Range), F2 (Cursor1) and F3 (Cursor2) keys. Refer to the each section for further details.

### TIM

Press the F4 (COU/TIM) key to toggle between the 2 modes (COU/TIM). In association with the previous F1 (Range), F2 (Cursor1) and F3 (Cursor2) keys, user can utilize TIM to check time parameters of each count per needs.



Note

This option is only available when “Recent” under HScale is selected.

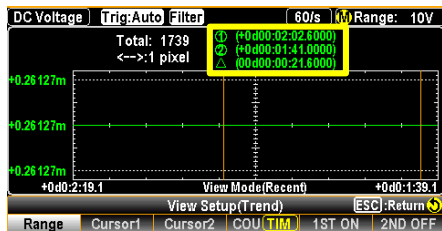



Yellow Sect. The time parameters of the selected lowest, highest and delta values display in the clear time format below, which indicate the exact day and time when the selected values occurred respectively.



F5 & F6 keys (1ST ON & 2ND ON) The Stop&View under Trend Chart is also applicable to the dual measurement. Activating dual measurement followed by entering this mode where the statistics are almost identical to those of the previous single measurement.

Display

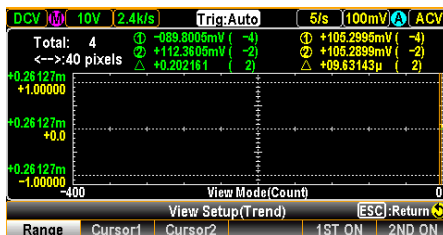

User can view each data for dual measurements or toggle on/off for either 1ST or 2ND channel at any time per requirement.

F6 (Start) key to restart measurement After entering the View Setup (Trend) mode, system will halt the measurement right away. Exit the View Setup (Trend) mode and press the F6 (Start) key to restart measurement.

When measurement is ongoing, press the F6 (ReStart) key to recount the accumulated measurements.

# Histogram

**Background** Shift to the Trend Chart display for each measurement.

**Step** 1. Press the DISP key followed by clicking the F2 (Display) key, the Display menu appears where several display options are available for selection.



2. Press the F4 (Histogram) key, the screen shows the Histogram mode for measurement display. The measured value is presented in the way of histogram for viewing, along with the maximum digits display depending on the Digit selection.



**Display**

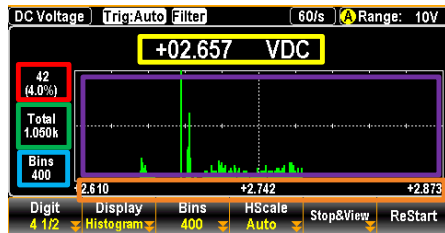

**Green Sect.** It indicates the total measured bins accumulated currently.

**Red Sect.** It indicates bins of the highest section of measured values with its affiliated percentage from the total counts of measurements.

Yellow Sect.	The currently measured value.
Purple Sect.	The histogram display for the measured bins. Up to the 400 latest bins can be shown concurrently.
Blue Sect.	The maximum bin numbers displayed within the purple section.
Orange Sect.	The range of horizontal scale of histogram display.

F3 (Bins) key to define bin numbers

Background

Press the F3 (Bins) key to enter the Bins Setup menu where user can customize the maximum numbers of stripe-like bins for display.

Note: The available options for bin numbers will vary in accordance with the defined refresh rate. Faster the refresh rate, smaller the numbers of bins available.

Display

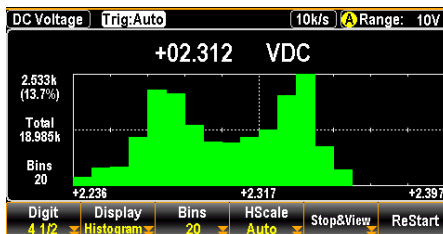

The histogram is defined with 20 bins display. The central line divides the left and right parts, each of which contains 10 bins respectively.

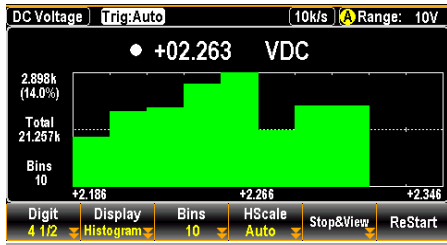

The 10 bins setting make the histogram display much thicker in its each bin compared to the previous 20 bins setting.

The max bin number varies by the refresh rate. Check the table below for correlative parameters.

Refresh Rate	5/s ~	4.8k/s	7.2k/s	10k/s
	2.4k/s			
Max. Bin Number	400	200	100	20

F4 (HScale) key to Background define horizontal scale

Press the F4 (HScale) key to enter the HScale Setup menu where Auto and Manual options are available for selection.

Auto

Selecting “Auto” allows the frequency of the measuring counts to be symmetric with the defined refresh rate. For example, setting 10k/s results in the fastest frequency, while 1s leading to the slowest frequency.

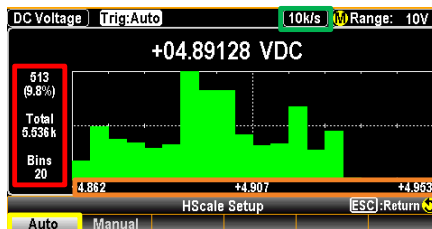

Yellow Sect. Press the F1 (Auto) key for auto HScale setup mode.

---

Green Sect. The user-defined refresh rate.

---

Red Sect. The frequency of the measured total counts, highest values percentage and bin numbers is consistent with the refresh rate.

---

Orange Sect. The range of horizontal scale of histogram display varies according to the currently measured value.

---

Manual Selecting “Manual” allows the horizontal scale of histogram display to be customized by user.

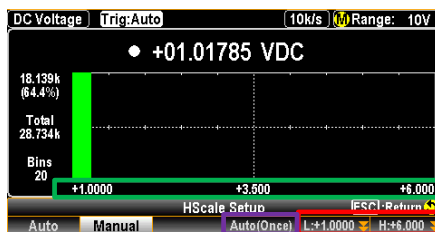

Red Sect. The user-specified highest and lowest scales. Press the F5 and F6 keys to set up individually.

---

Green Sect. The horizontal scale ranging from the right-side +6.000 to the left-hand +1.0000 that corresponds to the user-specified range of

---

horizontal scale.

Purple Sect. Press the F4 (Auto(Once)) key to obtain the highest and lowest scales from the latest bins of measurement within the histogram as a baseline for horizontal scale. Take the figure below for instance, the right and left ends in horizontal scale are irregular values +1.1022 and +1.0740 which come from the latest measurement of bins.

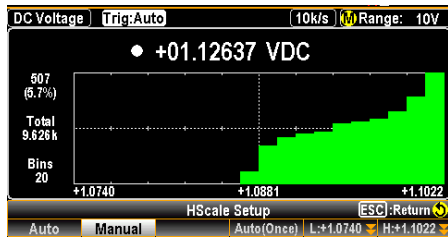

F5 (Stop&View) key for data

Press the F5 (Stop&View) key to enter the View Setup (His) mode which empowers user to have a detailed view into the measured data on the histogram. Once clicking the key, measurement will stop right away.

Display

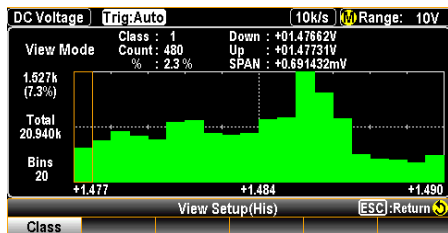

F1 key  
(Class)

Press the F1 (Class) key to check the detailed data of each bin from the histogram measurement.

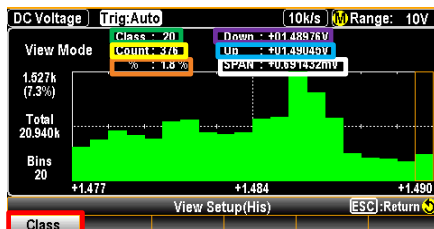

Red Sect. It indicates the Class mode under View Setup (His) is activated.

Green Sect. It indicates the selected bin number. Scroll the Knob key rightward or leftward to change bin number for checking.

Yellow Sect. It indicates the total accumulated counts of measurement categorized within the selected bin number.

Orange Sect. It indicates the exact percentage of the total counts of measurement from the selected bin number.

Purple Sect. It indicates the lowest value being measured within the selected bin number.

Blue Sect. It indicates the highest value being measured within the selected bin number.

---

White Sect. It indicates the difference in value between the purple section (Down) and the blue section (Up).

---

F6 (Start) key to restart measurement      After entering the View Setup (His) mode, system will halt the measurement right away. Exit the View Setup (His) mode and press the F6 (Start) key to restart measurement.

When measurement is ongoing, press the F6 (ReStart) key to recount the accumulated measurements.

---



# REMOTE CONTROL

---

Configure Interface .....	246
Return to Local Control Mode.....	246
Configure SCPI ID Setting .....	246
Configure USB Interface.....	248
Set the USB Protocol .....	250
Configure RS232 Interface.....	251
Set the FlowCtrl handshake.....	259
Set the EOL Character .....	259
Set the Separation Character.....	259
Insert GPIB Card (Optional).....	259
Configure GPIB Interface.....	260
Activate Ethernet Interface .....	264
Reboot LAN Setup .....	265
Configure Ethernet Interface to DHCP.....	266
Configure Ethernet IP .....	267
Configure Protocol.....	274
Remote Terminal Session (Telnet / TCP) .....	280
Command Syntax .....	282
Command Set .....	286
Speed & NPLC & Resolution Relation Table.....	298
Status system.....	370



# Configure Interface

## Return to Local Control Mode

**Background** When the unit is in remote control mode, the RMT icon  above the main display can be seen. When this icon is not displayed, it indicates that the unit is in local control mode.

In order to switch back to the Local control mode (front panel operation), press the Shift key.



## Configure SCPI ID Setting

**Background** The \*IDN? query returns the manufacturer, model number, serial number and system firmware version number. When SCPI ID is set to User, a user defined manufacturer and model number is returned with the \*IDN? query. Please see the SYSTem:IDNStr command on page 345 for details.

**Step** 1. Press the Menu key, and then the Page Down key repeatedly until the Interface configuration menu appears.

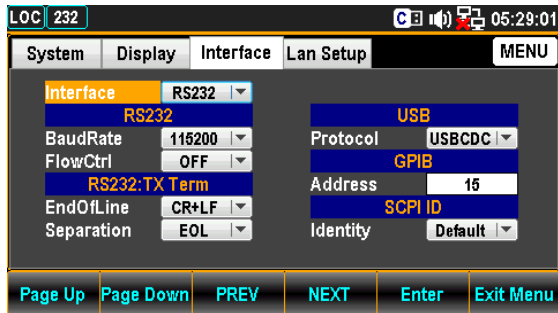
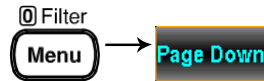

- Press the F4 (NEXT) key repeatedly or scroll the Knob key to move to the SCPI ID field.

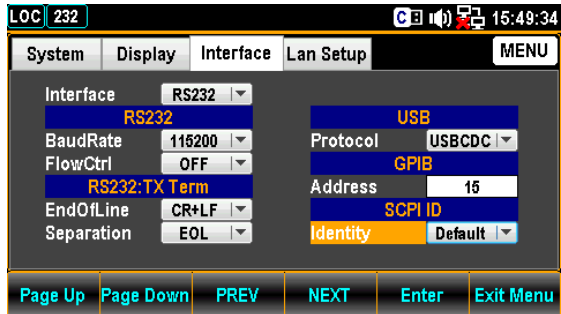

- Press the F5 (Enter) key or Knob key followed by scrolling Knob key or pressing +/- keys to land on the desired SCPI ID Identity option.

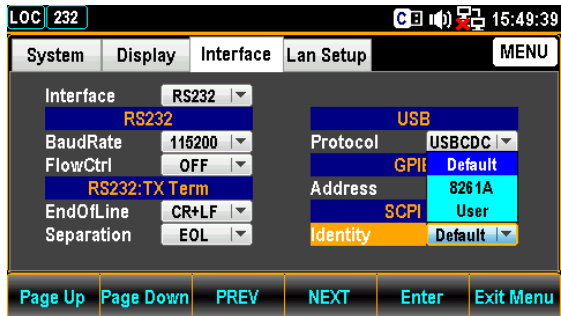

- Press the F5 (Enter) key or Knob key again to confirm the desired SCPI ID Identity option



## Configure USB Interface

USB Configuration	PC side connector	Front panel, Type A, host
	Unit side connector	Real panel, Type B, device
USB Speed		2.0 (Full speed)

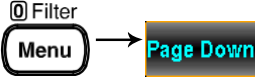
- Steps
1. Press the Menu key, and then the Page Down key repeatedly until the Interface configuration menu appears.
 

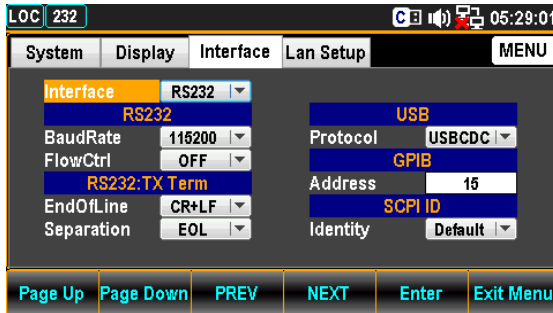

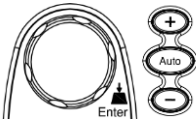
2. Press the F5 (Enter) key or Knob key followed by scrolling Knob key or pressing +/- keys to land on the USB option.
 

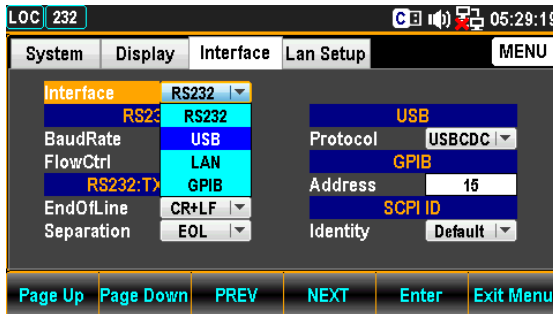

- Press the F5 (Enter) key or Knob key to select the USB option.

Enter

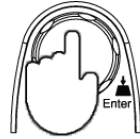

- Press the F4 (NEXT) key repeatedly or scroll the Knob key to move to the USB - Protocol field.

NEXT

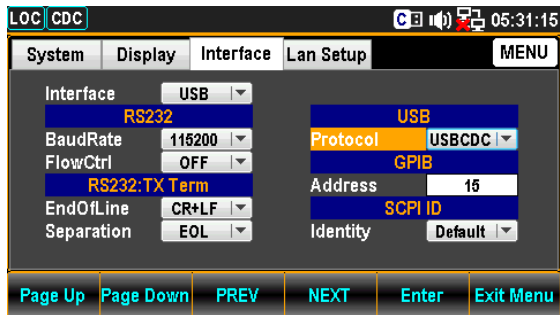
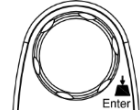

- Press the F5 (Enter) key or Knob key followed by scrolling Knob key or pressing +/- keys to land on the desired USB Protocol option.

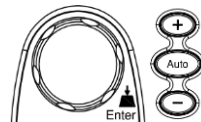

Enter

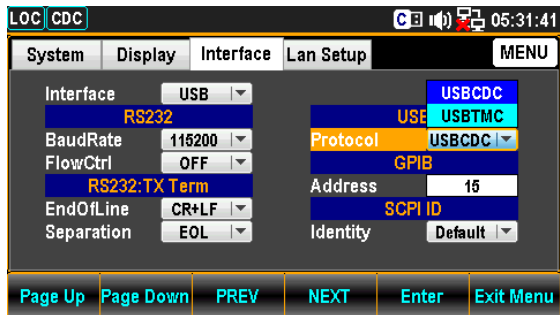

- 
6. Press the F5 (Enter) key or Knob key again to confirm the USB Protocol option.



- 
7. Connect the USB cable to the rear panel terminal (upper port).

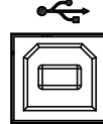

---

## Set the USB Protocol

---

### Description

The USB device port on the rear panel is used for remote control. The USB port can be configured as either a TMC or CDC interface.

Before the RSDM-9060/9061 can be used for remote control utilizing the CDC or TMC USB class, install the appropriate CDC or TMC USB driver included on the User Manual CD.

USBCDC:

The USB port on the RSDM-9060/9061 will appear as a virtual COM port to a connected PC.

USBTMC:

The RSDM-9060/9061 can be controlled using National Instruments NI-Visa software\*. NI-Visa supports USB TMC.



Note

\*To use the TMC interface National Instruments Measurement and Automation Explorer can be used. This program is available on the NI website, [www.ni.com](http://www.ni.com), via a search for the VISA Run-time Engine page, or “downloads” at the following URL, <http://www.ni.com/visa/>

## Configure RS232 Interface

RS232 Configuration	Connector	D-sub 9 pin, male
	Baud rate	115200/57600/38400/19200/9600
	Data bits	8
	Parity	none
	Stop bits	1
Flow control		none, RTS/CTS, DTR/DSR

Step

1. Press the Menu key, and then the Page Down key repeatedly until the Interface configuration menu appears.

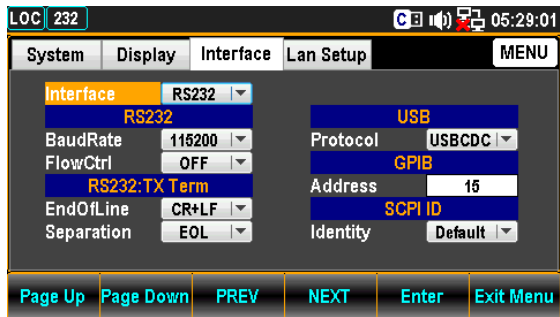

2. Press the F5 (Enter) key or Knob key followed by scrolling Knob key or pressing +/- keys to land on the RS232 option.

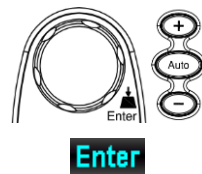

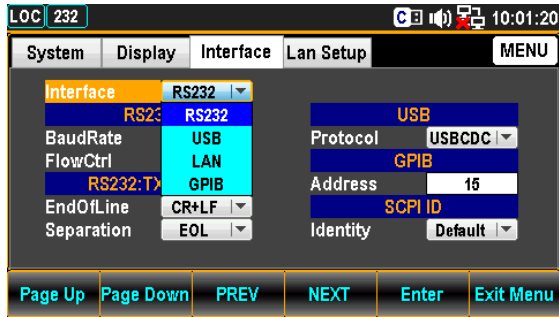

3. Press the F5 (Enter) key or Knob key to select the RS232 option.

**Enter**

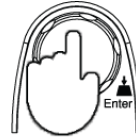

4. Press the F4 (NEXT) key repeatedly or scroll the Knob key to move to the RS232 - Baud Rate field.

**NEXT**

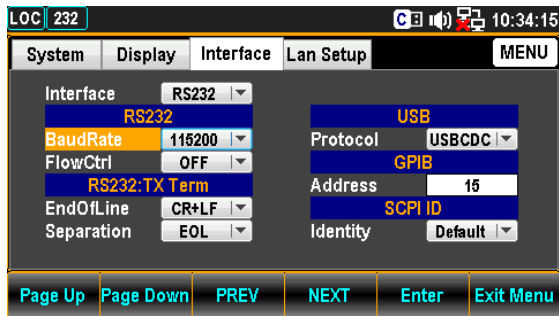

5. Press the F5 (Enter) key or Knob key followed by scrolling Knob key or pressing +/- keys to land on the desired RS232 Baud Rate option.

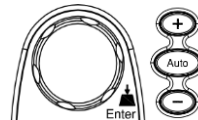

**Enter**



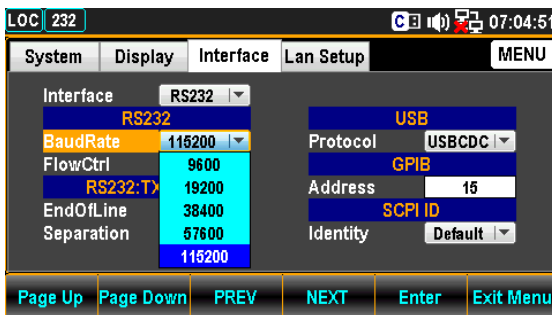

6. Press the F5 (Enter) key or Knob key again to confirm the desired RS232 Baud Rate option.

Enter

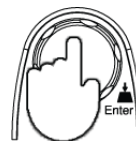

7. Press the F4 (NEXT) key repeatedly or scroll the Knob key to move to the RS232 - FlowCtrl field.

NEXT

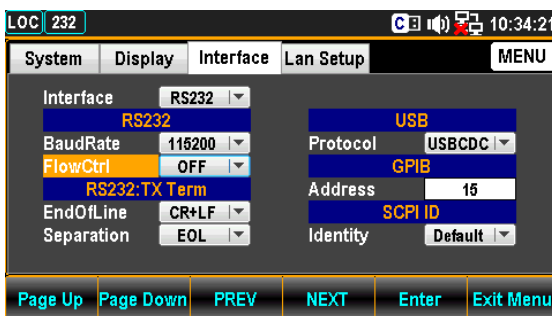
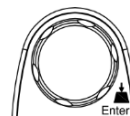

8. Press the F5 (Enter) key or Knob key followed by scrolling Knob key or pressing +/- keys to land on the desired RS232 FlowCtrl option.

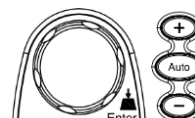

Enter

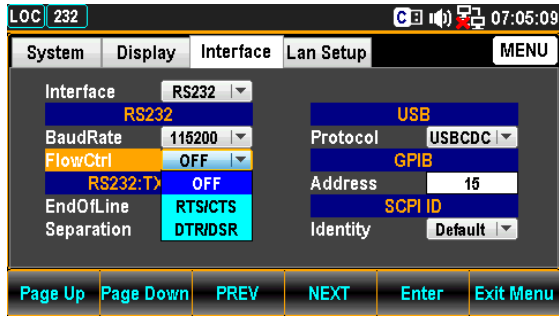

9. Press the F5 (Enter) key or Knob key again to confirm the desired RS232 FlowCtrl option.

**Enter**

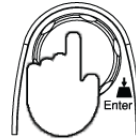

10. Press the F4 (NEXT) key repeatedly or scroll the Knob key to move to the RS232: TX Term - EndOfLine field.

**NEXT**

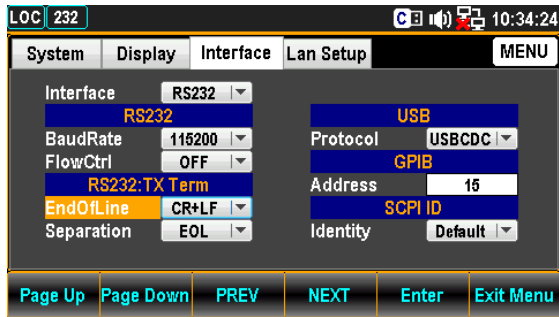
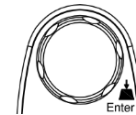

11. Press the F5 (Enter) key or Knob key followed by scrolling Knob key or pressing +/- keys to land on the desired RS232: TX Term - EndOfLine option.

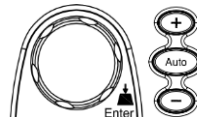

**Enter**

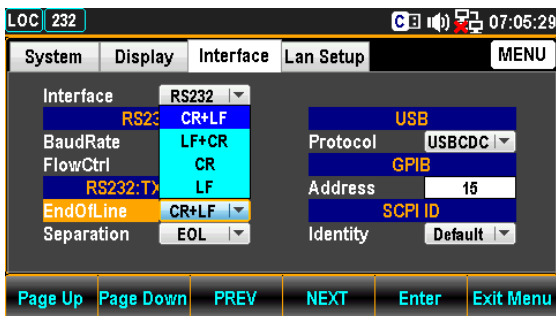

12. Press the F5 (Enter) key or Knob key again to confirm the desired RS232: TX Term EndOfLine option.

**Enter**

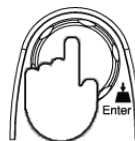

Note

GPIB, USBTMC and LAN are fixed with only LF option.

13. Press the F4 (NEXT) key repeatedly or scroll the Knob key to move to the RS232: TX Term - Separation field.

**NEXT**

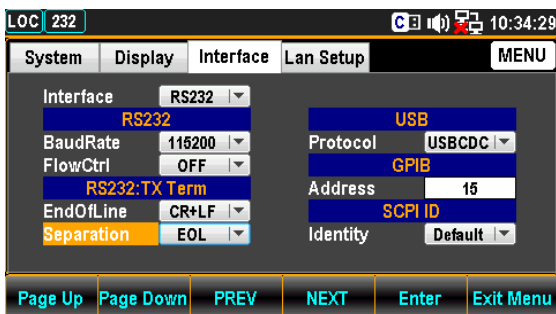
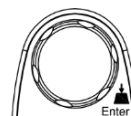

14. Press the F5 (Enter) key or Knob key followed by scrolling Knob key or pressing +/- keys to land on the desired RS232: TX Term - Separation option.

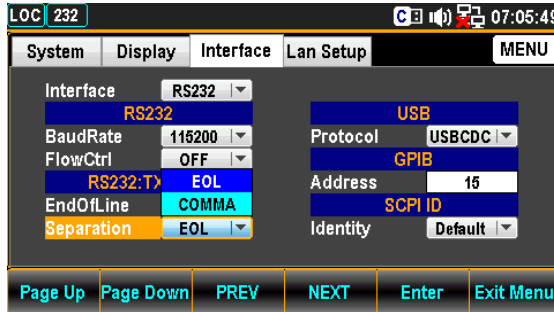
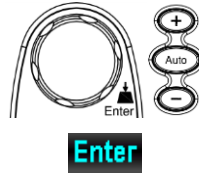

15. Press the F5 (Enter) key or Knob key again to confirm the desired RS232: TX Term Separation option.



Note

GPIO, USBTMC and LAN are fixed with only COMMA option.

16. Connect the RS232 cable to the rear panel terminal.

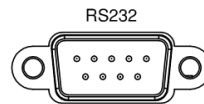

RS232 Pin Assignment

Pin	Input/Output	Description
1	-----	No Connection
2	Input	Receive Data (RxD)
3	Output	Transmit Data (TxD)
4	Output	Data Terminal Ready (DTR)
5	-----	Signal Ground (SG)

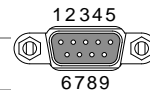

6	Input	Data Set Ready (DSR)
7	Input	Request To Send (RTS)
8	Output	Clear To Send (CTS)
9	-----	No Connection



Note

Do Not connect wire to pin 9 as it is specifically used for update function by certified factories.

### RS-232 Connection

RS232M-906X provides the complete RS-232 signals control. Select the corresponding null-modem cable, which has the DB-9 female connectors on both ends, when the port of DB-9 male connector on PC is utilized. The connecting diagram is shown as the following figure where the pin 2 (TxD) crossly links with the pin 3 (RxD) and the pin 5 (GND) is the necessary connection.

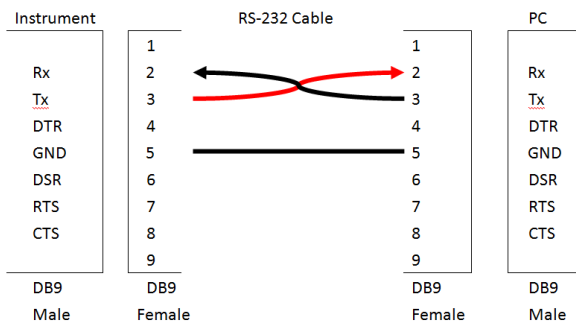

**GTL-234  
Connection**

An example below when optional accessory GTL-234 is being employed. Likewise, first crossly link the pin 2 (TxD) to the pin 3 (RxD) and the pin 5 (GND) is the necessary connection. Furthermore, crossly link the pin 7 (RTS) to pin 8 (CTS) for advanced function of GTL-234.

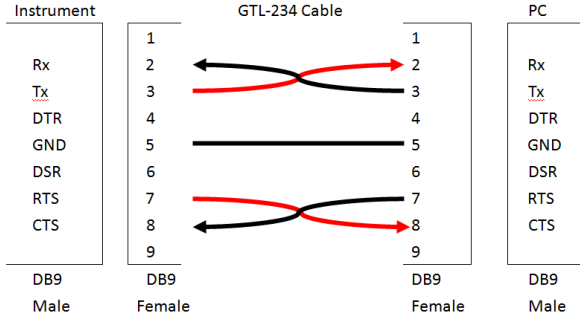

**More  
Connections**

If more other cables are applied, the diagram of full connections is illustrated as the following figure where the pin 2 (TxD), pin 3 (RxD) as well as pin 5 (GND), as mentioned previously, are necessary whilst the pin 4 (DTR), pin 6 (DSR), pin 7 (RTS) and pin 8 (CTS) are optionally required depending on different cables with varied functions to be used.

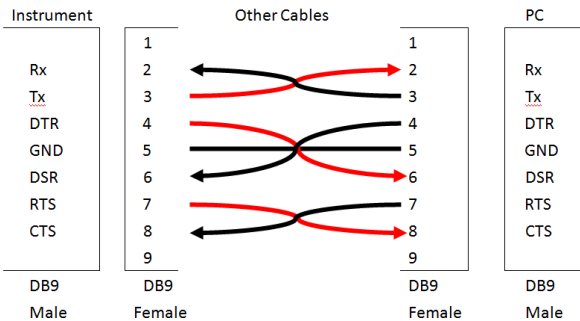

## Set the FlowCtrl handshake

---

Description      The FlowCtrl configuration menu can set the handshake for return messages.

---

## Set the EOL Character

---

Description      The TX TERM configuration menu can set the EOL (end-of-line) character for return messages.

The EOL characters that can be received from the PC include CR+LF, LF+CR, CR or LF. The most common EOL character is CR+LF.

---



Note

The USBTMC, GPIB and LAN's EOL character is fixed with LF.

---

EOL      CR+LF, LF+CR, CR, LF (default = CR+LF)

---

## Set the Separation Character

---

Description      The TX TERM configuration menu can set the separation character for multiple return measurement values.

---



Note

The USBTMC, GPIB and LAN's separation character is fixed with comma.

---

## Insert GPIB Card (Optional)

---

Power Off      Turn the Power Off and take out the power cord.

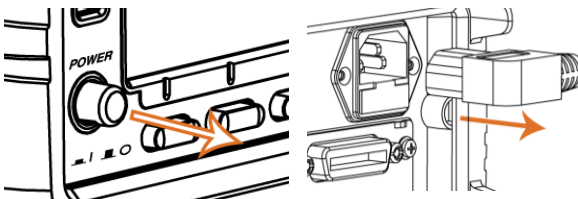

Open the RSDM-906X optional communication port

Take off the two screws on the slot corners to remove the optional communication port cover. Keep the screws for later reuse.

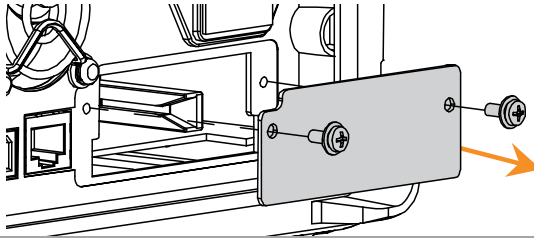

Insert the GPIB card

Insert the GPIB card into the slot. Close the cover by tightening the screws.

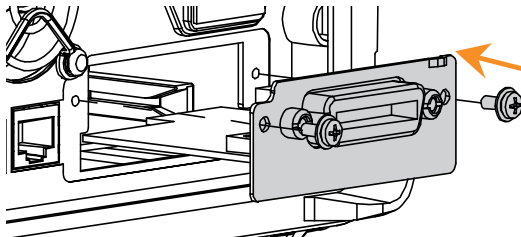

Power On

Connect the power cord and turn On the power.

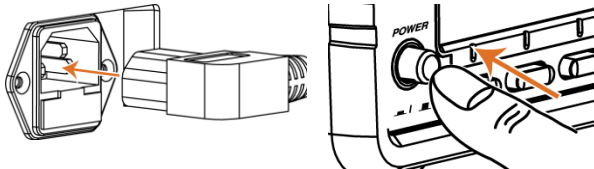

## Configure GPIB Interface

GPIB Configuration	Connector	24 Pin female GPIB port
	Address	0-30(default 15)

Step

1. Press the Menu key, and then the Page Down key repeatedly until the Interface configuration menu appears.

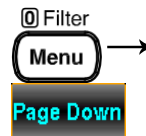



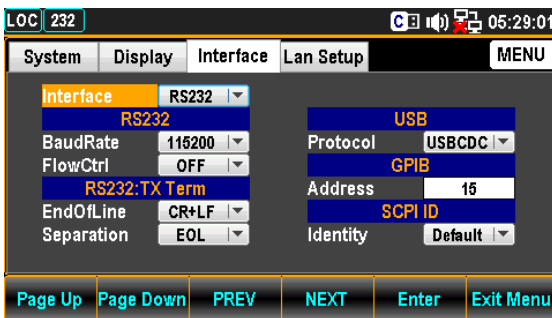

2. Press the F5 (Enter) key or Knob key followed by scrolling Knob key or pressing +/- keys to land on the GPIB option.

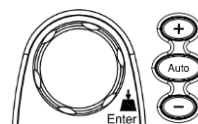

**Enter**

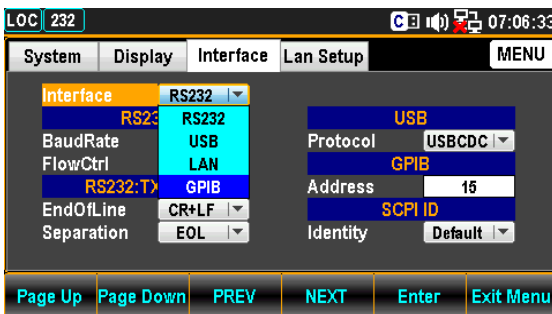

Note

As the figure shown below, GPIB option won't appear when optional GPIB card is not well installed.

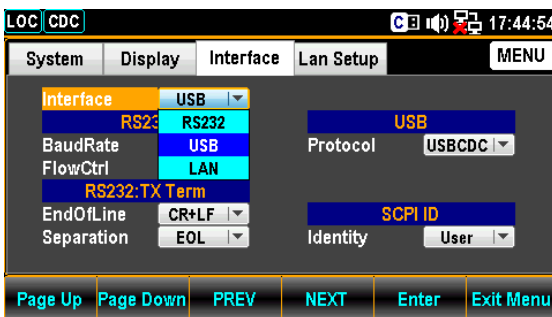

3. Press the F5 (Enter) key or Knob key to select the GPIB option.

**Enter**

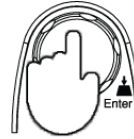

4. Press the F4 (NEXT) key repeatedly or scroll the Knob key to move to the GPIB - Address field.

**NEXT**

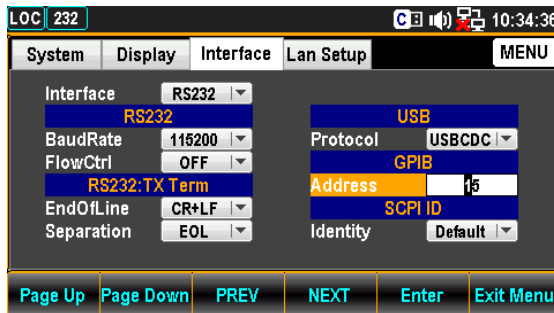

Note

As the figure shown below, the GPIB - Address field won't appear when optional GPIB card is not installed.

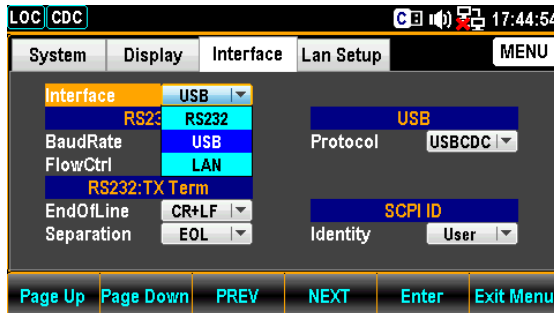

- Use the Left/Right keys to move the cursor followed by scrolling Knob key or pressing +/- keys to define GPIB Address. Also, you can press Number keys to directly input a specific digit.

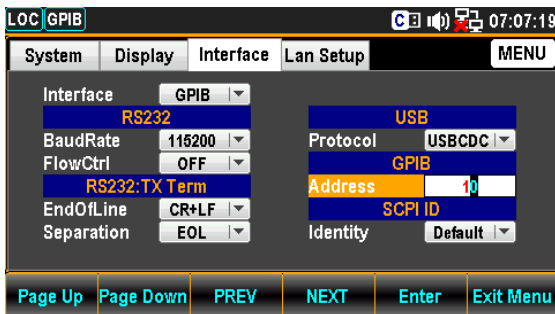
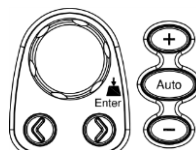

- Press the F5 (Enter) key or Knob key again to confirm the input digit for GPIB Address.

**Enter**

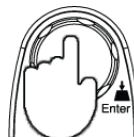

- Connect the GPIB cable to the rear panel optional communication port after the GPIB card has been installed.

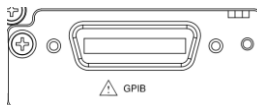

GPIB Pin Assignment

Pin	Signal	Pin	Signal
1	Data I/O 1	13	Data I/O 5
2	Data I/O 2	14	Data I/O 6
3	Data I/O 3	15	Data I/O 7
4	Data I/O 4	16	Data I/O 8
5	EOI	17	REN

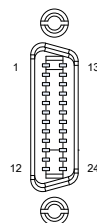

6	DAV	18	Ground (DAV)
7	NRFD	19	Ground (NRFD)
8	NDAC	20	Ground (NDAC)
9	IFC	21	Ground (IFC)
10	SRQ	22	Ground (SRQ)
11	ATN	23	Ground (ATN)
12	SHIELD Ground	24	Single GND

## Activate Ethernet Interface

Overview      Speed      10BaseT/100BaseTx

Ethernet(LAN)  
port activation

1. Press the Menu key, and then the Page Down key repeatedly until the Interface configuration menu appears.

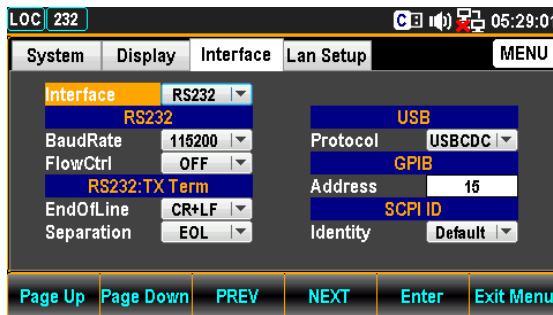
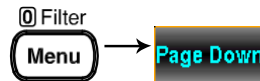

2. Press the F5 (Enter) key or Knob key followed by scrolling Knob key or pressing +/- keys to land on the LAN option.

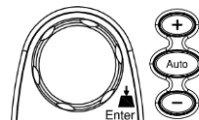

**Enter**

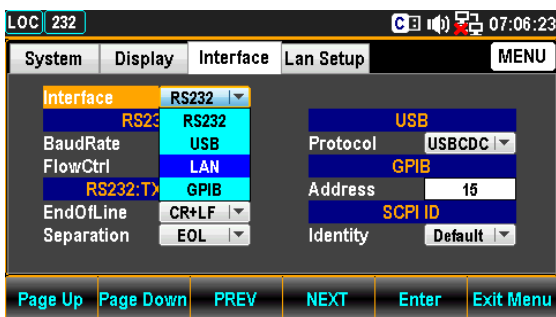

3. Press the F5 (Enter) key or Knob key to select the LAN option.

Enter

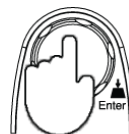

4. Connect the Ethernet cable to the rear panel Ethernet port.



## Reboot LAN Setup

### Background

To reboot is used to reset the Ethernet configuration when new settings have been made. When the Lan Setup settings have been edited, reboot to validate the changes and reset the Ethernet to the new configuration settings. New Ethernet configuration settings are only updated after the RSDM-906X has been reset.

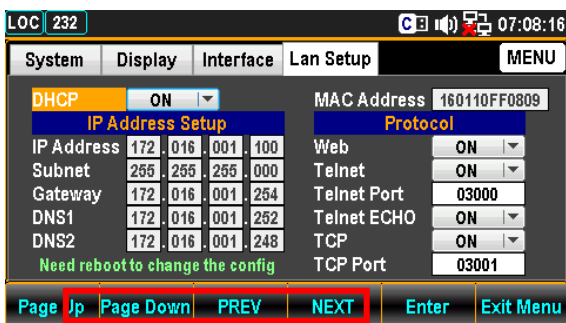

## Configure Ethernet Interface to DHCP

### Background

The RSDM-906X supports DHCP to have an IP address and other configuration parameters automatically assigned by a DHCP server.

### DHCP Configuration

1. Press the Menu key, and then the Page Down key repeatedly until the Lan Setup configuration menu appears.

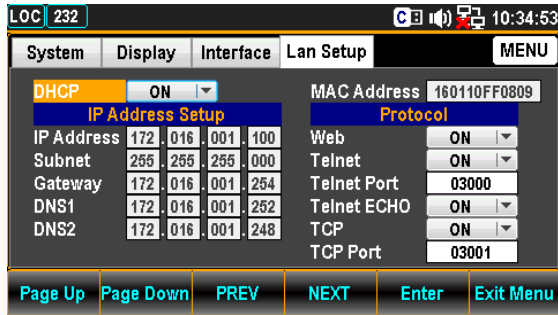
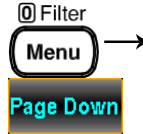

2. Press the F5 (Enter) key or Knob key followed by scrolling Knob key or pressing +/- keys to land on the ON option.

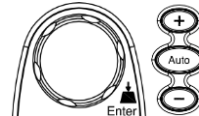

Enter

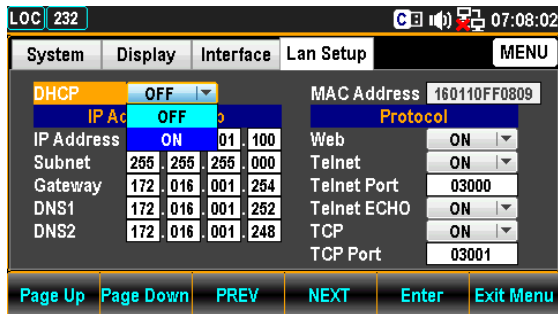

- Press the F5 (Enter) key or Knob key to select the DHCP ON option.

Enter

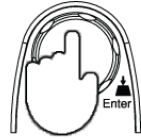

## Configure Ethernet IP

**Background** The RSDM-906X supports manually setting of the IP addresses, including the subnet mask, gateway, DNS1 and DNS2.



Note

The IP Address Setup can only be edited if DHCP is off.

**IP Address Configuration**

- Press the Menu key, and then the Page Down key repeatedly until the Lan Setup configuration menu appears.

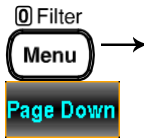

System	Display	Interface	Lan Setup	MENU
DHCP		OFF		MAC Address 160110FF0809
IP Address Setup			Protocol	
IP Address	172.016.001.100	Web	ON	
Subnet	255.255.255.000	Telnet	ON	
Gateway	172.016.001.254	Telnet Port	03000	
DNS1	172.016.001.252	Telnet ECHO	ON	
DNS2	172.016.001.248	TCP	ON	
		TCP Port	03001	
Page Up	Page Down	PREV	NEXT	Enter Exit Menu

- Press the F4 (NEXT) key repeatedly or scroll the Knob key to move to the IP Address Setup - IP Address field.

NEXT

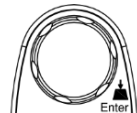

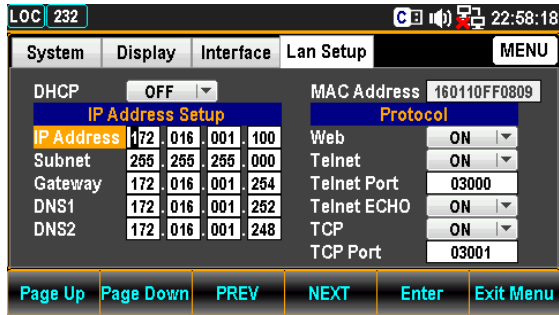

- Use the Left/Right keys to move the cursor followed by scrolling Knob key or pressing +/- keys to define IP Address. Also, you can press Number keys to directly input a specific digit.

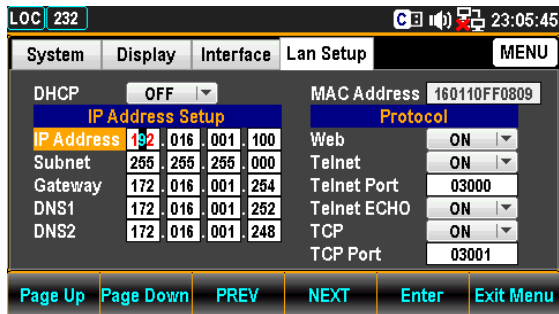
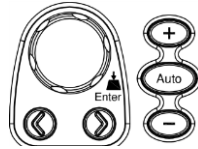

- Press the F5 (Enter) key or Knob key to confirm the input digit for IP1 Address. And the cursor will automatically jump to next groups.



- Repeat the steps 3 to 4 for IP2, IP3 and IP4.

Note

The IP address is divided in 4 groups; IP1:IP2:IP3:IP4.



Subnet Configuration

- Press the F4 (NEXT) key repeatedly or scroll the Knob key to move to the IP Address Setup - Subnet field.

**NEXT**

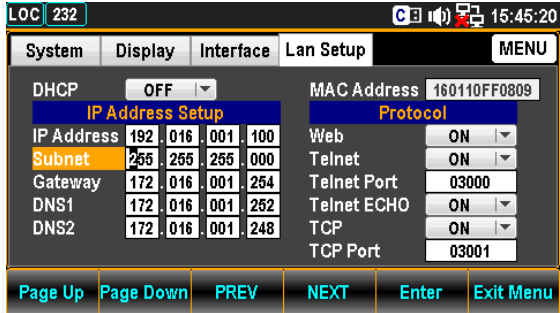
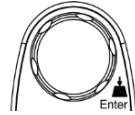

- Use the Left/Right keys to move the cursor followed by scrolling Knob key or pressing +/- keys to define Subnet. Also, you can press Number keys to directly input a specific digit.

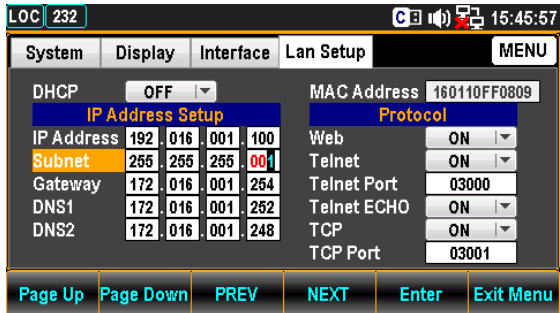
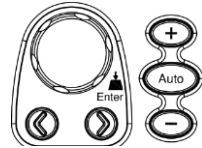

8. Press the F5 (Enter) key or Knob key again to confirm the input digit for S1. And the cursor will automatically jump to next groups.

**Enter**

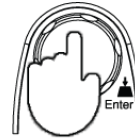

9. Repeat steps 7 to 8 for S2, S3 and S4.



Note

The Subnet is divided in 4 groups; S1:S2:S3:S4.

Gateway Configuration

10. Press the F4 (NEXT) key repeatedly or scroll the Knob key to move to the IP Address Setup – Gateway field.

**NEXT**

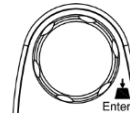

System	Display	Interface	Lan Setup	MENU			
DHCP		OFF		MAC Address 160110FF0809			
IP Address Setup		Protocol					
IP Address	192	016	001	100	Web	ON	
Subnet	255	255	255	001	Telnet	ON	
Gateway	172	016	001	254	Telnet Port	03000	
DNS1	172	016	001	252	Telnet ECHO	ON	
DNS2	172	016	001	248	TCP	ON	
					TCP Port	03001	
Page Up		Page Down		PREV	NEXT	Enter	Exit Menu

11. Use the Left/Right keys to move the cursor followed by scrolling Knob key or pressing +/- keys to define Gateway. Also, you can press Number keys to directly input a specific digit.

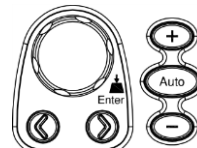

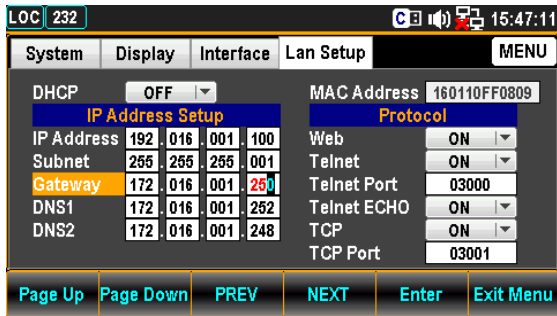

12. Press the F5 (Enter) key or Knob key to confirm the input digit for G1. And the cursor will automatically jump to next groups.



13. Repeat steps 11 to 12 for G2, G3 and G4.



Note

The Gateway is divided in 4 groups; G1:G2:G3:G4.

DNS1  
Configuration

14. Press the F4 (NEXT) key repeatedly or scroll the Knob key to move to the IP Address Setup - DNS1 field.

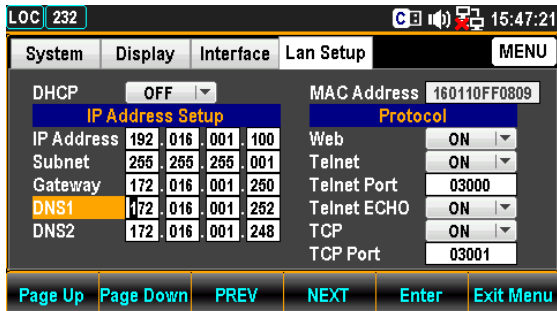

15. Use the Left/Right keys to move the cursor followed by scrolling Knob key or pressing +/- keys to define DNS1. Also, you can press Number keys to directly input a specific digit.

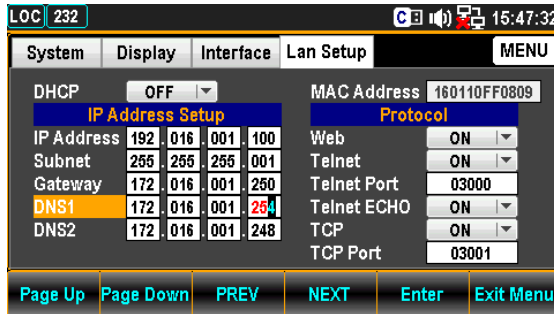
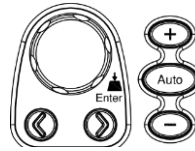

16. Press the F5 (Enter) key or Knob key again to confirm the input digit for D11. And the cursor will automatically jump to next groups.

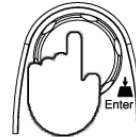

17. Repeat steps 15 to 16 for D12, D13 and D14.



Note

The Gateway is divided in 4 groups; D11:D12:D13:D14.

DNS2 Configuration

18. Press the F4 (NEXT) key repeatedly or scroll the Knob key to move to the IP Address Setup - DNS2 field.

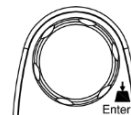

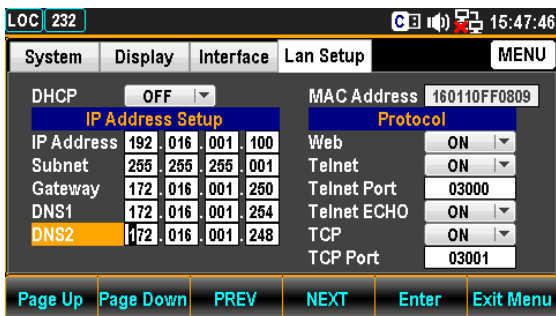

19. Use the Left/Right keys to move the cursor followed by scrolling Knob key or pressing +/- keys to define DNS2. Also, you can press Number keys to directly input a specific digit.

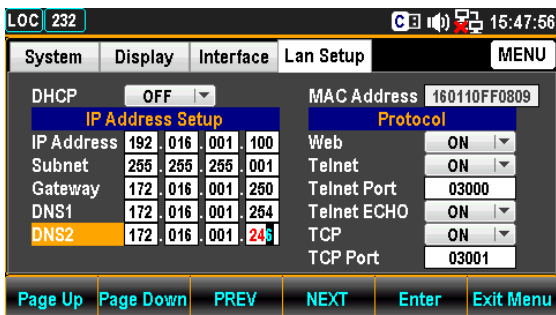
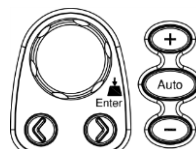

20. Press the F5 (Enter) key or Knob key again to confirm the input digit for D21. And the cursor will automatically jump to next groups.



21. Repeat steps 20 to 21 for D22, D23 and D24.



Note

The Gateway is divided in 4 groups;  
D21:D22:D23:D24.



## Configure Protocol

**Background** The RSDM-906X supports 3 Ethernet protocol to used, including the Web browser, Telnet and TCP.

**Web Configuration**

1. Press the Menu key, and then the Page Down key repeatedly until the Lan Setup configuration menu appears.

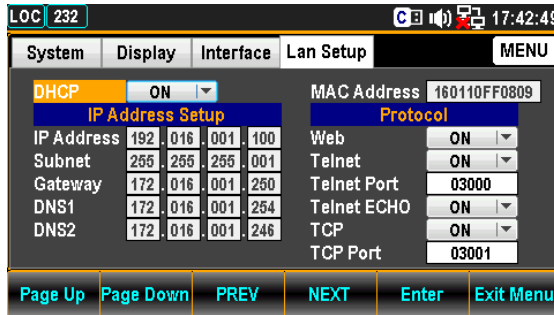
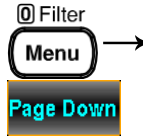

2. Press the F4 (NEXT) key repeatedly or scroll the Knob key to move to the Protocol - Web field.

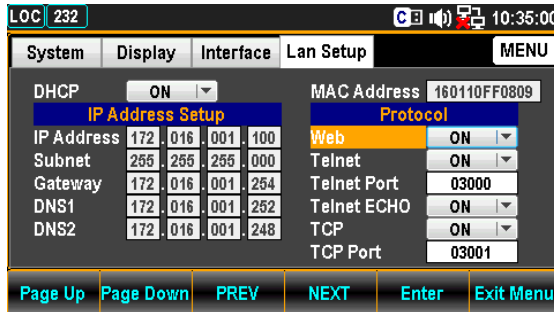

3. Press the F5 (Enter) key or Knob key followed by scrolling Knob key or pressing +/- keys to land on the ON option.

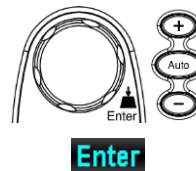

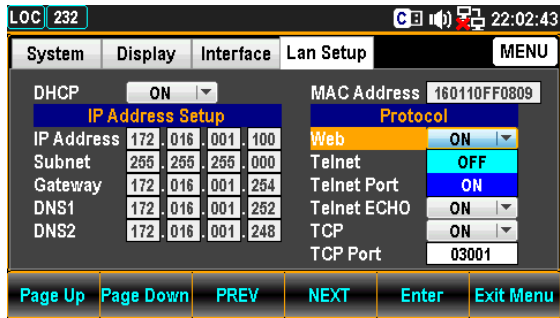

4. Press the F5 (Enter) key or Knob key to confirm the Web ON option.

**Enter**

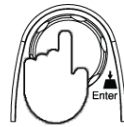

Telnet Configuration

5. Press the F4 (NEXT) key repeatedly or scroll the Knob key to move to the Protocol - Telnet field.

**NEXT**

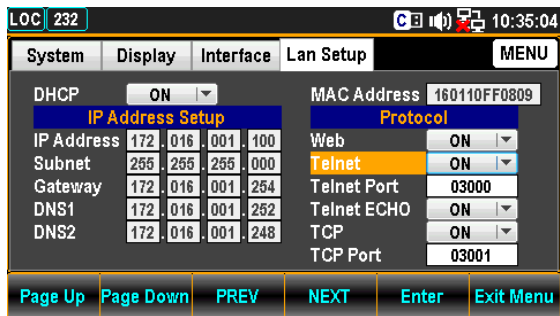
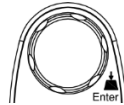

6. Press the F5 (Enter) key or Knob key followed by scrolling Knob key or pressing +/- keys to land on the ON option.

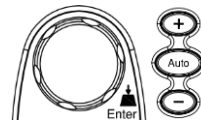

**Enter**

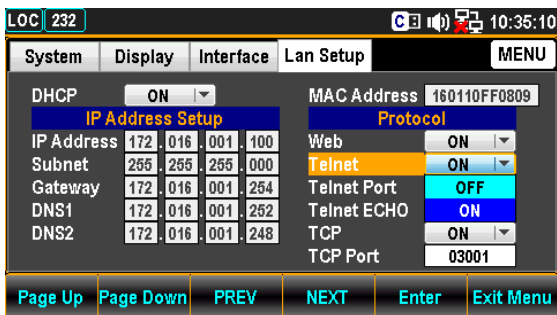

7. Press the F5 (Enter) key or Knob key to confirm the Telnet ON option.

Enter

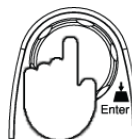

Telnet Port Configuration

8. Press the F4 (NEXT) key repeatedly or scroll the Knob key to move to the Protocol - Telnet Port field.

NEXT

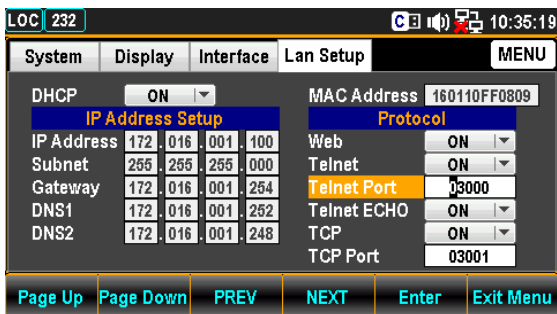
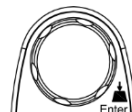



9. Use the Left/Right keys to move the cursor followed by scrolling Knob key or pressing +/- keys to define Telnet Port. Also, you can press Number keys to directly input a specific digit.

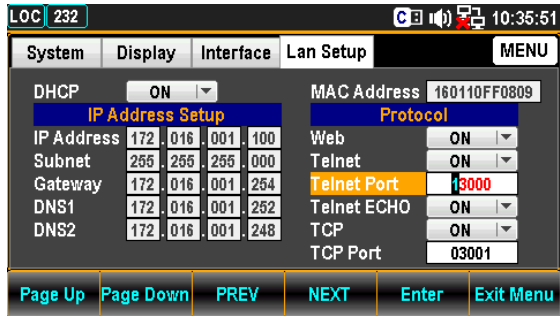
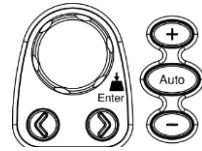

10. Press the F5 (Enter) key or Knob key to confirm the input digit for Telnet Port.

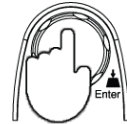

Range 1024~65535 (Default = 3000)

Telnet ECHO Configuration

11. Press the F4 (NEXT) key repeatedly or scroll the Knob key to move to the Protocol - Telnet ECHO field.

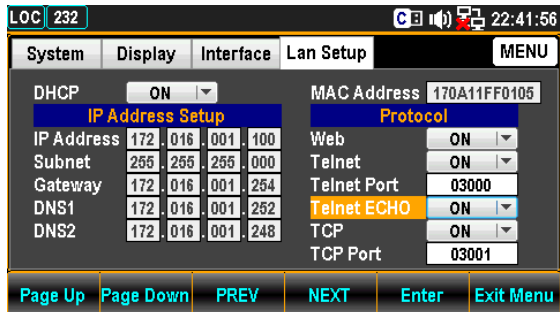
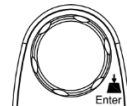

12. Press the F5 (Enter) key or Knob key followed by scrolling Knob key or pressing +/- keys to land on the ON option.

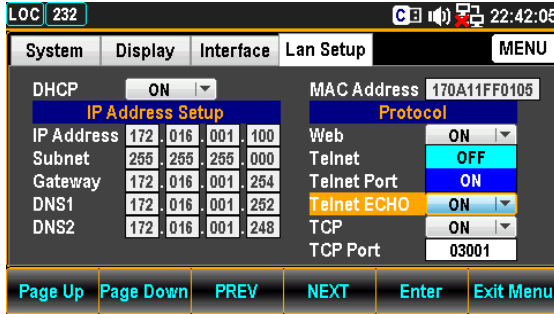
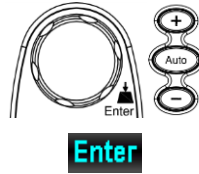

13. Press the F5 (Enter) key or Knob key again to confirm the Telnet ECHO ON option.



TCP Configuration

14. Press the F4 (NEXT) key repeatedly or scroll the Knob key to move to the Protocol - TCP field.

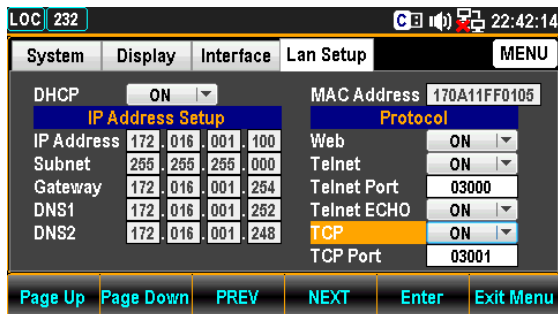

15. Press the F5 (Enter) key or Knob key followed by scrolling Knob key or pressing +/- keys to land on the ON option.

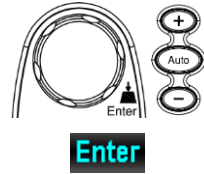

System		Display		Interface		Lan Setup		MENU	
DHCP		ON		MAC Address		170A11FF0105			
IP Address Setup						Protocol			
IP Address	172	016	001	100	Web	ON		▼	
Subnet	255	255	255	000	Telnet	ON		▼	
Gateway	172	016	001	254	Telnet Port	OFF			
DNS1	172	016	001	252	Telnet ECHO	ON			
DNS2	172	016	001	248	TCP	ON		▼	
					TCP Port	03001			
Page Up		Page Down		PREV		NEXT		Enter	
					Exit Menu				

16. Press the F5 (Enter) key or Knob key again to confirm the TCP ON option



### TCP Port Configuration

17. Press the F4 (NEXT) key repeatedly or scroll the Knob key to move to the Protocol - TCP Port field.



System		Display		Interface		Lan Setup		MENU	
DHCP		ON		MAC Address		170A11FF0105			
IP Address Setup						Protocol			
IP Address	172	016	001	100	Web	ON		▼	
Subnet	255	255	255	000	Telnet	ON		▼	
Gateway	172	016	001	254	Telnet Port	03000			
DNS1	172	016	001	252	Telnet ECHO	ON		▼	
DNS2	172	016	001	248	TCP	ON		▼	
					TCP Port	03001			
Page Up		Page Down		PREV		NEXT		Enter	
					Exit Menu				

18. Use the Left/Right keys to move the cursor followed by scrolling Knob key or pressing +/- keys to define TCP Port. Also, you can press Number keys to directly input a specific digit.

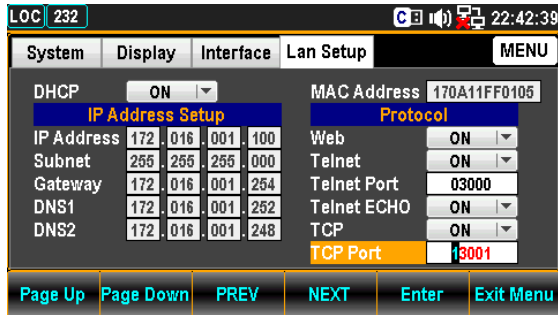
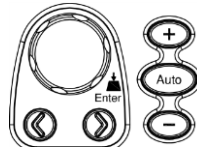

Range 1024~65535(Default = 3001)

19. Press the F5 (Enter) key or Knob key again to confirm the input digit for TCP Port.

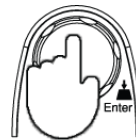

## Remote Terminal Session (Telnet / TCP)

**Background** A terminal application can be used to remotely control the RSDM-906X via the Telnet or TCP protocol.

**Operation**

1. Establish a connection via the Ethernet port.
2. Open a terminal program such as Hyper Terminal and enter the IP address and port number of the RSDM-906X.

3. Run this query via the terminal application:

```
*idn?
```

The command will return the instrument manufacturer, model number, serial number and firmware version in the following format:

```
>RSPRO, RSDM9061, 000000000,  
M0.69B_S0.25B
```



# Command Syntax

---

Compatible Standard	IEEE488.2	Partial compatibility
	SCPI, 1994	Partial compatibility
Command Structure	<p>SCPI (Standard Commands for Programmable Instruments) commands follow a tree-like structure, organized into nodes. Each level of the command tree is a node. Each keyword in a SCPI command represents each node in the command tree. Each keyword (node) of a SCPI command is separated by a colon (:).</p>	

For example, the diagram below shows an SCPI sub-structure and a command example.

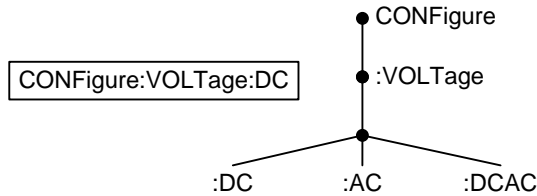

**Command Types** There are a number of different instrument commands and queries. A command sends instructions or data to the unit and a query receives data or status information from the unit.

## Command types

---

**Simple** A single command with/without a parameter

**Example** CONFigure:VOLTage:DC

---

**Query** A query is a simple or compound command followed by a question mark (?). A parameter (data) is returned.

**Example** CONFigure:RANGe?

---

**Command Forms** Commands and queries have two different forms, long and short. The command syntax is written with the short form of the command in capitals and the remainder (long form) in lower case.

The commands can be written either in capitals or lower-case, just so long as the short or long forms are complete. An incomplete command will not be recognized.

Below are examples of correctly written commands.

Long form	CONFigure:DIODe
	CONFIGURE:DIODE
	Configure:diode
Short form	CONF:DIOD conf:diod

**Square Brackets** Commands that contain square brackets indicate that the contents are optional. The function of the command is the same with or without the square bracketed items, as shown below. For example, for the query:

[SENSe:]UNIT?

Both SENSe:UNIT? and UNIT? are valid forms.

**Command Format**

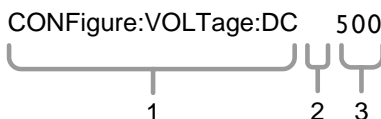

1. Command header
2. Space
3. Parameter 1

Common Input Parameters	Type	Description	Example
	<Boolean>	boolean logic	0, 1
	<NR1>	integers	0, 1, 2, 3
	<NR2>	decimal numbers	0.1, 3.14, 8.5

<NR3>	floating point with exponent	4.5e-1, 8.25e+1
<NRf>	any of NR1, 2, 3	1, 1.5, 4.5e-1
[MIN] (Optional parameter)	For commands, this will set the setting to the lowest value. This parameter can be used in place of any numerical parameter where indicated.	For queries, it will return the lowest possible value allowed for the particular setting.
[MAX] (Optional parameter)	For commands, this will set the setting to the highest value. This parameter can be used in place of any numerical parameter where indicated.	For queries, it will return the highest possible value allowed for the particular setting.
DEF	For commands, this will set the setting to the default value. This parameter can be used in place of any numerical parameter where indicated.	For queries, it will return the default value allowed for the particular setting.

---

Automatic parameter range selection      The RSDM-9060/9061 automatically sets the command parameter to the next available value.

---

Example      `conf:volt:dc 3`

This will set the measurement item to DC Voltage and the range to 10V. There is no 3V range so the DMM selects the next available range, 10V.

---



---

Message Terminator (EOL)	Remote Command	Marks the end of a command line. The following messages are in accordance with IEEE488.2 standard.  LF, CR, CR+LF, LF+CR The most common EOL character is CR+LF
--------------------------	----------------	---

---

Message Separator	EOL or ; (semicolon)	Command Separator
-------------------	----------------------	-------------------

---

# Command Set

---

ABORt.....	299
FETCh[X]? .....	299
HCOPy:SDUMp:DATA? .....	299
INITiate[:IMMEDIATE] .....	300
R? [<reading_number>].....	300
READ? .....	301
VAL? .....	301
VAL1?.....	301
VAL2? .....	301
ROUTe:TERMinate? .....	302
TIME:SYNC:SERVer.....	302
TIME:SYNC:SERVer? .....	302
CALCulate:CLEar[:IMMEDIATE] .....	303
CALCulate:DATA? .....	303
CALCulate:FUNCTion.....	303
CALCulate:FUNCTion? .....	303
CALCulate:HOLD:REFerence.....	303
CALCulate:HOLD:REFerence? .....	303
CALCulate:STATe .....	303
CALCulate:STATe?.....	303
CALCulate:AVERAge:ALL? .....	303
CALCulate:AVERAge:AVERAge?.....	304
CALCulate:AVERAge:CLEar[:IMMEDIATE] .....	304
CALCulate:AVERAge:COUNT? .....	304
CALCulate:AVERAge:MAXimum? .....	304
CALCulate:AVERAge:MINimum? .....	304
CALCulate:AVERAge:PTPeak?.....	304
CALCulate:AVERAge:SDEVIation?.....	304
CALCulate:AVERAge[:STATe].....	304
CALCulate:AVERAge[:STATe]? .....	304
CALCulate:LIMit:CLEar[:IMMEDIATE] .....	304
CALCulate:LIMit:BEEPer:MODE.....	304
CALCulate:LIMit:BEEPer:MODE? .....	304
CALCulate:LIMit:DATA? .....	305
CALCulate:LIMit:LOWer[:DATA].....	305
CALCulate:LIMit:LOWer[:DATA]? .....	305
CALCulate:LIMit:UPPer[:DATA].....	305
CALCulate:LIMit:UPPer[:DATA]? .....	305
CALCulate:LIMit[:STATe] .....	305
CALCulate:LIMit[:STATe]?.....	305
CALCulate:DB:REFerence.....	305
CALCulate:DB:REFerence? .....	305

CALCulate:DB:REFEre:METhod.....	306
CALCulate:DB:REFEre:METhod? .....	306
CALCulate:DBM:REFEre.....	306
CALCulate:DBM:REFEre? .....	306
CALCulate:SCALe:REFEre:AUTO .....	306
CALCulate:SCALe:REFEre:AUTO?.....	306
CALCulate:MATH:MMFactor .....	306
CALCulate:MATH:MMFactor?.....	306
CALCulate:MATH:MBFactor .....	306
CALCulate:MATH:MBFactor?.....	307
CALCulate:MATH:PERCent.....	307
CALCulate:MATH:PERCent?.....	307
CALCulate:TCHart[:STATe].....	307
CALCulate:TCHart [:STATe]?.....	307
CALCulate:TRANsform:HISTogram[:STATe] .....	307
CALCulate:TRANsform:HISTogram[:STATe]? .....	307
CALCulate:TRANsform:HISTogram:ALL? .....	307
CALCulate:TRANsform:HISTogram:CLEAr [:IMMediate].....	308
CALCulate:TRANsform:HISTogram:COUNT? .....	308
CALCulate:TRANsform:HISTogram:DATA? .....	308
CALCulate:TRANsform:HISTogram:POINts .....	308
CALCulate:TRANsform:HISTogram:POINts? .....	308
CALCulate:TRANsform:HISTogram:RANGe :AUTO .....	308
CALCulate:TRANsform:HISTogram:RANGe :AUTO?.....	308
CALCulate:TRANsform:HISTogram:RANGe :LOWer.....	309
CALCulate:TRANsform:HISTogram:RANGe :LOWer?.....	309
CALCulate:TRANsform:HISTogram:RANGe :UPPer .....	309
CALCulate:TRANsform:HISTogram:RANGe :UPPer?.....	309
CALCulate:TRANsform:HISTogram[:STATe] .....	309
CALCulate:TRANsform:HISTogram[:STATe]? .....	309
CONFigure? .....	309
CONFigure[:VOLTagE]:DC.....	309
CONFigure[:VOLTagE][:DC]:RATio.....	310
CONFigure[:VOLTagE]:AC .....	310
CONFigure:CURREnt[:DC] .....	310
CONFigure:CURREnt:AC .....	311
CONFigure:RESistance .....	311
CONFigure:FRESistance.....	311

CONFigure:FREQuency .....	312
CONFigure:PERiod.....	312
CONFigure:CAPacitance .....	312
CONFigure:CONTinuity .....	312
CONFigure:DIODE.....	312
CONFigure:TEMPerature .....	312
CONFigure2[:VOLTage]:DC.....	313
CONFigure2[:VOLTage]:AC .....	313
CONFigure2:CURREnt[:DC] .....	313
CONFigure2:CURREnt:AC .....	314
CONFigure2:FREQuency .....	314
CONFigure2:PERiod.....	314
CONFigure2:OFF .....	314
DATA[X]:LAST?.....	314
DATA:POINts?.....	315
DATA:POINts:EVENT:THReshold .....	315
DATA:POINts:EVENT:THReshold?.....	315
DATA:REMOve? <reading_number>,[WAIT] .....	315
DIGital:INTErface:MODE.....	316
DIGital:INTErface:MODE? .....	316
DIGital:INTErface:DATA:OUTPut .....	316
DIGital:INTErface:DATA:SETup .....	316
DISPlay[:STATe] .....	316
DISPlay[:STATe]? .....	316
DISPlay:TEXT:CLEAr.....	317
DISPlay:TEXT[:DATA] .....	317
DISPlay:TEXT[::DATA]?.....	317
DISPlay:VIEW .....	317
DISPlay:VIEW? .....	317
MEASure[:VOLTage]:DC?.....	317
MEASure[:VOLTage][::DC]:RATio? .....	318
MEASure[:VOLTage]:AC? .....	318
MEASure:CURREnt[:DC]? .....	318
MEASure:CURREnt:AC? .....	318
MEASure:RESistance?.....	319
MEASure:FRESistance? .....	319
MEASure:FREQuency? .....	319
MEASure:PERiod?.....	320
MEASure:CAPacitance.....	320
MEASure:CONTinuity? .....	320
MEASure:DIODE?.....	320
MEASure:TEMPerature? .....	320
MEASure2[:VOLTage]:DC?.....	321
MEASure2[:VOLTage]:AC? .....	321
MEASure2:CURREnt[:DC]?.....	321

MEASure2:CURRent:AC?	321
MEASure2:FREQuency?	322
MEASure2:PERiod?	322
[SENSe:]FUNCTion[X]	322
[SENSe:]FUNCTion[X]?	322
[SENSe:]DATA?	322
[SENSe:]DIGital:SHIFt	323
[SENSe:]DIGital:SHIFt?	323
[SENSe:]UNIT	323
[SENSe:]UNIT?	323
[SENSe:]AVErAge:COUNt[X]	323
[SENSe:]AVErAge:COUNt[X]?	323
[SENSe:]AVErAge:STATe[X]	323
[SENSe:]AVErAge:STATe[X]?	323
[SENSe:]AVErAge:TCONtrol[X]	324
[SENSe:]AVErAge:TCONtrol[X]?	324
[SENSe:]AVErAge:WINDow[X]	324
[SENSe:]AVErAge:WINDow[X]?	324
[SENSe:]AVErAge:WINDow:METHod[X]	324
[SENSe:]AVErAge:WINDow:METHod[X]?	324
[SENSe:]CAPacitance:CABLe:CALibratoin	324
[SENSe:]CAPacitance:RANGe	325
[SENSe:]CAPacitance:RANGe?	325
[SENSe:]CAPacitance:RANGe:AUTO	325
[SENSe:]CAPacitance:RANGe:AUTO?	325
[SENSe:]CONTinuity:NPLCycles	325
[SENSe:]CONTinuity:NPLCycles?	325
[SENSe:]CONTinuity:RESolution	325
[SENSe:]CONTinuity:RESolution?	325
[SENSe:]CONTinuity:THReshold	326
[SENSe:]CONTinuity:THReshold?	326
[SENSe:]CONTinuity:TRIGger:DELay	326
[SENSe:]CONTinuity:TRIGger:DELay?	326
[SENSe:]CONTinuity:ZERO:AUTO	326
[SENSe:]CONTinuity:ZERO:AUTO?	326
[SENSe:]DIODE:NPLCycles	326
[SENSe:]DIODE:NPLCycles?	327
[SENSe:]DIODE:RESolution	327
[SENSe:]DIODE:RESolution?	327
[SENSe:]DIODE:TRIGger:DELay	327
[SENSe:]DIODE:TRIGger:DELay?	327
[SENSe:]DIODE:ZERO:AUTO	327
[SENSe:]DIODE:ZERO:AUTO?	327
[SENSe:]VOLTage[:DC]:IMPedance:AUTO	327
[SENSe:]VOLTage[:DC]:IMPedance:AUTO?	328

[SENSe:]VOLTage[:DC]:NPLCycles.....	328
[SENSe:]VOLTage[:DC]:NPLCycles? .....	328
[SENSe:]VOLTage[:DC]:NULL[:STATe] .....	328
[SENSe:]VOLTage[:DC]:NULL[:STATe]? .....	328
[SENSe:]VOLTage[:DC]:NULL:VALue.....	328
[SENSe:]VOLTage[:DC]:NULL:VALue? .....	328
[SENSe:]VOLTage[:DC]:NULL:VALue:AUTO .....	329
[SENSe:]VOLTage[:DC]:NULL:VALue:AUTO? .....	329
[SENSe:]VOLTage[:DC]:RANGe.....	329
[SENSe:]VOLTage[:DC]:RANGe? .....	329
[SENSe:]VOLTage[:DC]:RANGe:AUTO .....	329
[SENSe:]VOLTage[:DC]:RANGe:AUTO? .....	329
[SENSe:]VOLTage[:DC]:RESolution.....	329
[SENSe:]VOLTage[:DC]:RESolution? .....	329
[SENSe:]VOLTage[:DC]:TRIGger:DELay .....	329
[SENSe:]VOLTage[:DC]:TRIGger:DELay?.....	330
[SENSe:]VOLTage[:DC]:ZERO:AUTO .....	330
[SENSe:]VOLTage[:DC]:ZERO:AUTO?.....	330
[SENSe:]VOLTage:AC:BANDwidth.....	330
[SENSe:]VOLTage:AC:BANDwidth? .....	330
[SENSe:]VOLTage:AC:NULL[:STATe] .....	330
[SENSe:]VOLTage:AC:NULL[:STATe]?.....	330
[SENSe:]VOLTage:AC:NULL:VALue.....	330
[SENSe:]VOLTage:AC:NULL:VALue? .....	330
[SENSe:]VOLTage:AC:NULL:VALue:AUTO.....	331
[SENSe:]VOLTage:AC:NULL:VALue:AUTO? .....	331
[SENSe:]VOLTage:AC:RANGe.....	331
[SENSe:]VOLTage:AC:RANGe? .....	331
[SENSe:]VOLTage:AC:RANGe:AUTO .....	331
[SENSe:]VOLTage:AC:RANGe:AUTO? .....	331
[SENSe:]VOLTage:AC:TRIGger:DELay .....	331
[SENSe:]VOLTage:AC:TRIGger:DELay?.....	331
[SENSe:]CURRent[:DC]:NPLCycles .....	332
[SENSe:]CURRent[:DC]:NPLCycles? .....	332
[SENSe:]CURRent[:DC]:NULL[:STATe].....	332
[SENSe:]CURRent[:DC]:NULL[:STATe]? .....	332
[SENSe:]CURRent[:DC]:NULL:VALue .....	332
[SENSe:]CURRent[:DC]:NULL:VALue? .....	332
[SENSe:]CURRent[:DC]:NULL:VALue:AUTO .....	333
[SENSe:]CURRent[:DC]:NULL:VALue:AUTO?.....	333
[SENSe:]CURRent[:DC]:RANGe .....	333
[SENSe:]CURRent[:DC]:RANGe?.....	333
[SENSe:]CURRent[:DC]:RANGe:AUTO .....	333
[SENSe:]CURRent[:DC]:RANGe:AUTO?.....	333
[SENSe:]CURRent[:DC]:RESolution .....	333

[SENSe:]CURRent[:DC]:RESolution? .....	333
[SENSe:]CURRent[:DC]:TERMinals.....	333
[SENSe:]CURRent[:DC]:TERMinals?.....	333
[SENSe:]CURRent[:DC]:TRIGger:DELay.....	334
[SENSe:]CURRent[:DC]:TRIGger:DELay?.....	334
[SENSe:]CURRent[:DC]:ZERO:AUTO .....	334
[SENSe:]CURRent[:DC]:ZERO:AUTO? .....	334
[SENSe:]CURRent:AC:BANDwidth .....	334
[SENSe:]CURRent:AC:BANDwidth? .....	334
[SENSe:]CURRent:AC:NULL[:STATe] .....	334
[SENSe:]CURRent:AC:NULL[:STATe]? .....	334
[SENSe:]CURRent:AC:NULL:VALue.....	334
[SENSe:]CURRent:AC:NULL:VALue? .....	335
[SENSe:]CURRent:AC:NULL:VALue:AUTO .....	335
[SENSe:]CURRent:AC:NULL:VALue:AUTO? .....	335
[SENSe:]CURRent:AC:RANGe .....	335
[SENSe:]CURRent:AC:RANGe? .....	335
[SENSe:]CURRent:AC:RANGe:AUTO .....	335
[SENSe:]CURRent:AC:RANGe:AUTO? .....	335
[SENSe:]CURRent:AC:TERMinals .....	335
[SENSe:]CURRent:AC:TERMinals?.....	335
[SENSe:]CURRent:AC:TRIGger:DELay.....	335
[SENSe:]CURRent:AC:TRIGger:DELay?.....	336
[SENSe:]RESistance:NPLCycles .....	336
[SENSe:]RESistance:NPLCycles?.....	336
[SENSe:]RESistance:NULL[:STATe].....	336
[SENSe:]RESistance:NULL[:STATe]?.....	336
[SENSe:]RESistance:NULL:VALue .....	336
[SENSe:]RESistance:NULL:VALue?.....	337
[SENSe:]RESistance:NULL:VALue:AUTO .....	337
[SENSe:]RESistance:NULL:VALue:AUTO?.....	337
[SENSe:]RESistance:RANGe .....	337
[SENSe:]RESistance:RANGe?.....	337
[SENSe:]RESistance:RANGe:AUTO.....	337
[SENSe:]RESistance:RANGe:AUTO?.....	337
[SENSe:]RESistance:RESolution.....	337
[SENSe:]RESistance:RESolution?.....	337
[SENSe:]RESistance:TRIGger:DELay.....	338
[SENSe:]RESistance:TRIGger:DELay? .....	338
[SENSe:]RESistance:ZERO:AUTO .....	338
[SENSe:]RESistance:ZERO:AUTO? .....	338
[SENSe:]FREStance:NPLCycles.....	338
[SENSe:]FREStance:NPLCycles? .....	338
[SENSe:]FREStance:NULL[:STATe] .....	339
[SENSe:]FREStance:NULL[:STATe]?.....	339

[SENSe:]FREStance:NULL:VALue.....	339
[SENSe:]FREStance:NULL:VALue? .....	339
[SENSe:]FREStance:NULL:VALue:AUTO .....	339
[SENSe:]FREStance:NULL:VALue:AUTO? .....	339
[SENSe:]FREStance:RANGe .....	339
[SENSe:]FREStance:RANGe? .....	339
[SENSe:]FREStance:RANGe:AUTO .....	340
[SENSe:]FREStance:RANGe:AUTO? .....	340
[SENSe:]FREStance:RESolution .....	340
[SENSe:]FREStance:RESolution? .....	340
[SENSe:]FREStance:TRIGger:DELay.....	340
[SENSe:]FREStance:TRIGger:DELay? .....	340
[SENSe:]FREStance:ZERO:AUTO.....	340
[SENSe:]FREStance:ZERO:AUTO? .....	340
[SENSe:]FREQuency:APERture .....	341
[SENSe:]FREQuency:APERture? .....	341
[SENSe:]FREQuency:CURREnt:RANGe.....	341
[SENSe:]FREQuency:CURREnt:RANGe? .....	341
[SENSe:]FREQuency:CURREnt:RANGe:AUTO .....	341
[SENSe:]FREQuency:CURREnt:RANGe:AUTO? .....	341
[SENSe:]FREQuency:INPutjack .....	341
[SENSe:]FREQuency:INPutjack? .....	341
[SENSe:]FREQuency:NULL[:STATe].....	341
[SENSe:]FREQuency:NULL[:STATe]? .....	342
[SENSe:]FREQuency:NULL:VALue .....	342
[SENSe:]FREQuency:NULL:VALue?.....	342
[SENSe:]FREQuency:NULL:VALue:AUTO .....	342
[SENSe:]FREQuency:NULL:VALue:AUTO?.....	342
[SENSe:]FREQuency:TIMEout:AUTO .....	342
[SENSe:]FREQuency:TIMEout:AUTO?.....	342
[SENSe:]FREQuency:TRIGger:DELay .....	342
[SENSe:]FREQuency:TRIGger:DELay? .....	342
[SENSe:]FREQuency:VOLTage:RANGe .....	343
[SENSe:]FREQuency:VOLTage:RANGe?.....	343
[SENSe:]FREQuency:VOLTage:RANGe:AUTO .....	343
[SENSe:]FREQuency:VOLTage:RANGe:AUTO?.....	343
[SENSe:]PERiod:APERture .....	343
[SENSe:]PERiod:APERture? .....	343
[SENSe:]PERiod:CURREnt:RANGe.....	343
[SENSe:]PERiod:CURREnt:RANGe? .....	343
[SENSe:]PERiod:CURREnt:RANGe:AUTO .....	343
[SENSe:]PERiod:CURREnt:RANGe:AUTO? .....	343
[SENSe:]PERiod:INPutjack .....	344
[SENSe:]PERiod:INPutjack?.....	344
[SENSe:]PERiod:NULL[:STATe] .....	344



[SENSe:]PERiod:NULL[:STATe]? .....	344
[SENSe:]PERiod:NULL:VALue .....	344
[SENSe:]PERiod:NULL:VALue? .....	344
[SENSe:]PERiod:NULL:VALue:AUTO .....	344
[SENSe:]PERiod:NULL:VALue:AUTO? .....	344
[SENSe:]PERiod:TIMEout:AUTO .....	344
[SENSe:]PERiod:TIMEout:AUTO? .....	345
[SENSe:]PERiod:TRIGger:DELay .....	345
[SENSe:]PERiod:TRIGger:DELay? .....	345
[SENSe:]PERiod:VOLTage:RANGe .....	345
[SENSe:]PERiod:VOLTage:RANGe? .....	345
[SENSe:]PERiod:VOLTage:RANGe:AUTO .....	345
[SENSe:]PERiod:VOLTage:RANGe:AUTO? .....	345
[SENSe:]TEMPerature:NPLCycles .....	345
[SENSe:]TEMPerature:NPLCycles? .....	346
[SENSe:]TEMPerature:NULL[:STATe] .....	346
[SENSe:]TEMPerature:NULL[:STATe]? .....	346
[SENSe:]TEMPerature:NULL:VALue .....	346
[SENSe:]TEMPerature:NULL:VALue? .....	346
[SENSe:]TEMPerature:NULL:VALue:AUTO .....	346
[SENSe:]TEMPerature:NULL:VALue:AUTO? .....	346
[SENSe:]TEMPerature:RESolution .....	346
[SENSe:]TEMPerature:RESolution? .....	347
[SENSe:]TEMPerature:TRANsducer:TYPE .....	347
[SENSe:]TEMPerature:TRANsducer:TYPE? .....	347
[SENSe:]TEMPerature:TRIGger:DELay .....	347
[SENSe:]TEMPerature:TRIGger:DELay? .....	347
[SENSe:]TEMPerature:ZERO:AUTO .....	347
[SENSe:]TEMPerature:ZERO:AUTO? .....	347
[SENSe:]TEMPerature:RJUNction:SIMulated .....	347
[SENSe:]TEMPerature:RJUNction:SIMulated? .....	347
[SENSe:]TEMPerature:RJUNction:SIMulated :AUTO .....	348
[SENSe:]TEMPerature:RJUNction:SIMulated :AUTO? .....	348
[SENSe:]TEMPerature:RJUNction:SIMulated :AUTO:OFFSet .....	348
[SENSe:]TEMPerature:RJUNction:SIMulated :AUTO:OFFSet? .....	348
[SENSe:]TEMPerature:RJUNction:SIMulated :AUTO:TEMPerature? .....	348
[SENSe:]TEMPerature:TCouple:TYPE .....	348
[SENSe:]TEMPerature:TCouple:TYPE? .....	348
[SENSe:]TEMPerature:RTD:ALPHa .....	348
[SENSe:]TEMPerature:RTD:ALPHa? .....	349

[SENSe:]TEMPerature:RTD:BETA .....	349
[SENSe:]TEMPerature:RTD:BETA? .....	349
[SENSe:]TEMPerature:RTD:DELTA .....	349
[SENSe:]TEMPerature:RTD:DELTA? .....	349
[SENSe:]TEMPerature:RTD:RESistance	
[:REFerence] .....	349
[SENSe:]TEMPerature:RTD:RESistance	
[:REFerence]? .....	349
[SENSe:]TEMPerature:RTD:TYPE .....	349
[SENSe:]TEMPerature:RTD:TYPE? .....	349
[SENSe:]TEMPerature:FRTD:ALPHA .....	349
[SENSe:]TEMPerature:FRTD:ALPHA? .....	349
[SENSe:]TEMPerature:FRTD:BETA .....	349
[SENSe:]TEMPerature:FRTD:BETA? .....	349
[SENSe:]TEMPerature:FRTD:DELTA .....	350
[SENSe:]TEMPerature:FRTD:DELTA? .....	350
[SENSe:]TEMPerature:FRTD:RESistance	
[:REFerence] .....	350
[SENSe:]TEMPerature:FRTD:RESistance	
[:REFerence]? .....	350
[SENSe:]TEMPerature:FRTD:TYPE .....	350
[SENSe:]TEMPerature:FRTD:TYPE? .....	350
[SENSe:]TEMPerature:THERmistor:APARAmeter .....	350
[SENSe:]TEMPerature:THERmistor:APARAmeter? .....	350
[SENSe:]TEMPerature:THERmistor:BPARAmeter .....	350
[SENSe:]TEMPerature:THERmistor:BPARAmeter? .....	350
[SENSe:]TEMPerature:THERmistor:CPARAmeter .....	350
[SENSe:]TEMPerature:THERmistor:CPARAmeter? .....	350
[SENSe:]TEMPerature:THERmistor:TYPE .....	351
[SENSe:]TEMPerature:THERmistor:TYPE? .....	351
[SENSe:]TEMPerature:FTHERmistor:APARAmeter .....	351
[SENSe:]TEMPerature:FTHERmistor:APARAmeter? .....	351
[SENSe:]TEMPerature:FTHERmistor:BPARAmeter .....	351
[SENSe:]TEMPerature:FTHERmistor:BPARAmeter? .....	351
[SENSe:]TEMPerature:FTHERmistor:CPARAmeter .....	351
[SENSe:]TEMPerature:FTHERmistor:CPARAmeter? .....	351
[SENSe:]TEMPerature:FTHERmistor:TYPE .....	351
[SENSe:]TEMPerature:FTHERmistor:TYPE? .....	351
SAMPlE:COUNT .....	352
SAMPlE:COUNT? .....	352
TRIGger:COUNT .....	352
TRIGger:COUNT? .....	352
TRIGger:DELay .....	352
TRIGger:DELay? .....	352
TRIGger:DELay:AUTO .....	353

TRIGger:DELAy:AUTO?	353
TRIGger:SLOPe	353
TRIGger:SLOPe?	353
TRIGger:SOURce	353
TRIGger:SOURce?	354
OUTPut:TRIGger:SLOPe	354
OUTPut:TRIGger:SLOPe?	354
SYSTem:BEEPer[:IMMediate]	355
SYSTem:BEEPer:ERRor	355
SYSTem:BEEPer:ERRor?	355
SYSTem:BEEPer:STATe	355
SYSTem:BEEPer:STATe?	355
SYSTem:BEEPer:COMPare:VOLume	355
SYSTem:BEEPer:COMPare:VOLume?	355
SYSTem:BEEPer:CONTInuity:VOLume	355
SYSTem:BEEPer:CONTInuity:VOLume?	356
SYSTem:BEEPer:HOLD:VOLume	356
SYSTem:BEEPer:HOLD:VOLume?	356
SYSTem:CLICk:STATe	356
SYSTem:CLICk:STATe?	356
SYSTem:DATE	356
SYSTem:DATE?	356
SYSTem:DISPlay	356
SYSTem:DISPlay?	356
SYSTem:ERRor[:NEXT]?	356
SYSTem:IDNStr	357
SYSTem:IDNStr?	357
SYSTem:LABel	357
SYSTem:LABel?	357
SYSTem:LFRequency?	357
SYSTem:OUTPut:EOF	357
SYSTem:OUTPut:EOF?	357
SYSTem:OUTPut:SEParate	358
SYSTem:OUTPut:SEParate?	358
SYSTem:PARAmeter:LOAD	358
SYSTem:PARAmeter:LOAD?	358
SYSTem:PARAmeter:SAVE	358
SYSTem:PRESet	358
SYSTem:SCPi:MODE	358
SYSTem:SCPi:MODE?	359
SYSTem:SERial?	359
SYSTem:TEMPerature?	359
SYSTem:TIME	359
SYSTem:TIME?	359
SYSTem:UPTime?	359

SYSTem:VERSion?	359
SYSTem:WMESsage	359
SYSTem:WMESsage?	359
SYSTem:COMMunicate:GPIB:ADDRess	360
SYSTem:COMMunicate:GPIB:ADDRess?	360
SYSTem:COMMunicate:LAN:DHCP	360
SYSTem:COMMunicate:LAN:DHCP?	360
SYSTem:COMMunicate:LAN:DNS[X]	360
SYSTem:COMMunicate:LAN:DNS[X]?	360
SYSTem:COMMunicate:LAN:GATeway	360
SYSTem:COMMunicate:LAN:GATeway?	360
SYSTem:COMMunicate:LAN:HOSTname	361
SYSTem:COMMunicate:LAN:HOSTname?	361
SYSTem:COMMunicate:LAN:IPADdress	361
SYSTem:COMMunicate:LAN:IPADdress?	361
SYSTem:COMMunicate:LAN:MAC?	361
SYSTem:COMMunicate:LAN:SMASK	361
SYSTem:COMMunicate:LAN:SMASK?	361
SYSTem:COMMunicate:LAN:TELNet:ECHO	361
SYSTem:COMMunicate:LAN:TELNet:ECHO?	361
SYSTem:COMMunicate:LAN:TELNet:ENABle	361
SYSTem:COMMunicate:LAN:TELNet:ENABle?	362
SYSTem:COMMunicate:LAN:TELNet:PORT	362
SYSTem:COMMunicate:LAN:TELNet:PORT?	362
SYSTem:COMMunicate:LAN:TELNet:PROMpt	362
SYSTem:COMMunicate:LAN:TELNet:PROMpt?	362
SYSTem:COMMunicate:LAN:TELNet:TIMeout	362
SYSTem:COMMunicate:LAN:TELNet:TIMeout?	362
SYSTem:COMMunicate:LAN:TELNet:WMESsage	362
SYSTem:COMMunicate:LAN:TELNet:WMESsage?	362
SYSTem:COMMunicate:LAN:TCP:ENABle	363
SYSTem:COMMunicate:LAN:TCP:ENABle?	363
SYSTem:COMMunicate:LAN:TCP:PORT	363
SYSTem:COMMunicate:LAN:TCP:PORT?	363
SYSTem:COMMunicate:LAN:TIMeout	363
SYSTem:COMMunicate:LAN:TIMeout?	363
SYSTem:COMMunicate:LAN:WEB:ENABle	363
SYSTem:COMMunicate:LAN:WEB:ENABle?	363
SYSTem:LOCAl	364
SYSTem:REMote	364
SYSTem:RWLock	364
STATus:OPERation:CONDition?	364
STATus:OPERation:ENABle	364
STATus:OPERation:ENABle?	364
STATus:OPERation[:EVENt]?	365

STATus:PRESet .....	365
STATus:QUEStionable:CONDition? .....	365
STATus:QUEStionable:ENABle .....	365
STATus:QUEStionable:ENABle?.....	365
STATus:QUEStionable[:EVENT]?.....	366
*CLS.....	366
*ESE? .....	366
*ESE .....	366
*ESR?.....	366
*IDN? .....	367
*OPC?.....	367
*OPC .....	367
*OPT? .....	367
*PSC.....	368
*PSC? .....	368
*RCL.....	368
*RST .....	368
*SAV .....	368
*SRE?.....	368
*SRE .....	369
*STB? .....	369
*TRG .....	369
*WAI.....	369

---

## Speed & NPLC & Resolution Relation Table

Speed	5/s	20/s	60(50)/s	100/s	400/s	1.2k/s	2.4k/s	4.8k/s	7.2k/s	10k/s
NPLC (16.6ms)	12	3	1	0.6	0.15	0.05	0.025	0.0125	0.0083	0.006
Resolution(Range * PPM)										
Range PPM	1	2	3	10	20	50	100	200	400	500
1n	1.0E-15	2.0E-15	3.0E-15	1.0E-14	2.0E-14	5.0E-14	1.0E-13	2.0E-13	4.0E-13	5.0E-13
10n	1.0E-14	2.0E-14	3.0E-14	1.0E-13	2.0E-13	5.0E-13	1.0E-12	2.0E-12	4.0E-12	5.0E-12
100n	1.0E-13	2.0E-13	3.0E-13	1.0E-12	2.0E-12	5.0E-12	1.0E-11	2.0E-11	4.0E-11	5.0E-11
1μ	1.0E-12	2.0E-12	3.0E-12	1.0E-11	2.0E-11	5.0E-11	1.0E-10	2.0E-10	4.0E-10	5.0E-10
10μ	1.0E-11	2.0E-11	3.0E-11	1.0E-10	2.0E-10	5.0E-10	1.0E-09	2.0E-09	4.0E-09	5.0E-09
100μ	1.0E-10	2.0E-10	3.0E-10	1.0E-09	2.0E-09	5.0E-09	1.0E-08	2.0E-08	4.0E-08	5.0E-08
1m	1.0E-09	2.0E-09	3.0E-09	1.0E-08	2.0E-08	5.0E-08	1.0E-07	2.0E-07	4.0E-07	5.0E-07
10m	1.0E-08	2.0E-08	3.0E-08	1.0E-07	2.0E-07	5.0E-07	1.0E-06	2.0E-06	4.0E-06	5.0E-06
100m	1.0E-07	2.0E-07	3.0E-07	1.0E-06	2.0E-06	5.0E-06	1.0E-05	2.0E-05	4.0E-05	5.0E-05
1	1.0E-06	2.0E-06	3.0E-06	1.0E-05	2.0E-05	5.0E-05	1.0E-04	2.0E-04	4.0E-04	5.0E-04
3	3.0E-06	6.0E-06	9.0E-06	3.0E-05	6.0E-05	1.5E-04	3.0E-04	6.0E-04	1.2E-03	1.5E-03
10	1.0E-05	2.0E-05	3.0E-05	1.0E-04	2.0E-04	5.0E-04	1.0E-03	2.0E-03	4.0E-03	5.0E-03
100	1.0E-04	2.0E-04	3.0E-04	1.0E-03	2.0E-03	5.0E-03	1.0E-02	2.0E-02	4.0E-02	5.0E-02
1k	1.0E-03	2.0E-03	3.0E-03	1.0E-02	2.0E-02	5.0E-02	1.0E-01	2.0E-01	4.0E-01	5.0E-01
10k	1.0E-02	2.0E-02	3.0E-02	1.0E-01	2.0E-01	5.0E-01	1.0E+00	2.0E+00	4.0E+00	5.0E+00
100k	1.0E-01	2.0E-01	3.0E-01	1.0E+00	2.0E+00	5.0E+00	1.0E+01	2.0E+01	4.0E+01	5.0E+01
1M	1.0E+00	2.0E+00	3.0E+00	1.0E+01	2.0E+01	5.0E+01	1.0E+02	2.0E+02	4.0E+02	5.0E+02
10M	1.0E+01	2.0E+01	3.0E+01	1.0E+02	2.0E+02	5.0E+02	1.0E+03	2.0E+03	4.0E+03	5.0E+03
100M	1.0E+02	2.0E+02	3.0E+02	1.0E+03	2.0E+03	5.0E+03	1.0E+04	2.0E+04	4.0E+04	5.0E+04
 Note	The above contents of table are only references to NPLC and Resolution mentioned within SCPI commands.									

## Other Commands

---

### ABORT

Aborts a measurement in progress, returning the instrument to the trigger idle state.

- Use this to abort a measurement when the instrument is waiting for a trigger, or for aborting a long measurement or series of measurements.

---

### FETCh[X]?

Waits for measurements to complete and copies all available measurements to the instrument's output buffer. The readings remain in reading memory.

X = null or 1 indicate 1<sup>st</sup> display value, X = 2 indicate 2<sup>nd</sup> display value

Example: SAMP:COUN 3

INIT

FETC?

Returns: -4.98748741E-01,-4.35163427E-01,-4.33118686E-01

- The FETCh? query does not erase measurements from the reading memory. You can send the query multiple times to retrieve the same data.
- You can store up to 10,000 measurements in the reading memory of the RSDM-9060 or 100,000 measurements on the RSDM-9061. If reading memory overflows, new measurements overwrite the oldest measurements stored; the most recent measurements are always preserved. No error is generated, but the Reading Mem Ovfl bit (bit 14) is set in the Questionable Data Register's condition register.

---

### HCOPY:SDUMp:DATA?

Executes TFT LCD screenshot action.

Returns the front panel display image ("screen shot").

Returns a count of data streaming by the image file format of BMP.

---

---

## INITiate[:IMMediate]

Changes the state of the triggering system from "idle" to "wait-for-trigger", and clears the previous set of measurements from reading memory. Measurements begin when the specified trigger conditions are satisfied following the receipt of INIT.

Example: CONF:VOLT:DC 10

SAMP:COUN 5

TRIG:SOUR BUS

INIT

\*TRG

FETC?

- Storing measurements in reading memory with INITiate is faster than sending measurements to the instrument's output buffer using READ? (provided you do not send FETCh? until done). The INITiate command is also an "overlapped" command. This means that after executing INITiate, you can send other commands that do not affect the measurements.
- To retrieve the measurements from the reading memory, use FETCh?. Use DATA:REMOve? or R? to read and erase all or part of the available measurements.
- Use ABORt to return to idle.

---

## R? [<reading\_number>]

Reads and erases measurements from reading memory up to the specified <reading\_number>.

The measurements are read and erased from the reading memory starting with the oldest measurement first.

Ex: SAMP:COUN 5

INIT

R? 4

Returns: #263-1.12816521E-04,-1.13148354E-04,-1.13485152E-04,-1.13365632E-04

"#2" represents the length of readback data is 2 digits.

"63" represents the total length of readback data.

- If you do not specify a value for <reading\_numbe>, all measurements are read and erased.

Ex: SAMP:COUN 2

INIT

R?

Returns: #231-1.12816521E-04,-1.13148354E-04

- The R? and DATA:REMOve? queries can be used during a long series of readings to periodically remove readings from memory that would normally cause the reading memory to
-



overflow. R? does not wait for all readings to complete. It sends the readings that are complete at the time the instrument receives the command.

- Use Read? or Fetch? if you want the instrument to wait until all readings are complete before sending readings.
- No error is generated if the reading memory contains less readings than requested. In this case, all available readings in memory are read and deleted.

#### READ?

Returns 1<sup>st</sup> display value.

Return parameter: <NRF>, Ex: -1.13148354E-04

- The Read query will not return the unit or count number of the reading.
- Sending READ? is similar to sending INITi te followed immediately by FETCh?

#### VAL?

Returns the 1<sup>st</sup> and 2<sup>nd</sup> display value.

Example: SAMP:COUN 5

VAL?

>+0.33452387E-4,+0.38954687E-4

>+0.32897125E-4,+0.32764551E-4

> etc, for 5 counts.

Queries 5 counts of stored samples from the reading memory.

#### VAL1?

Returns the 1<sup>st</sup> display value.

Example: SAMP:COUN 5

VAL1?

>+0.33452387E-4

>+0.32897125E -4

> etc, for 5 counts.

Queries 5 counts of stored samples from the 1<sup>st</sup> display.

#### VAL2?

Returns the 2<sup>nd</sup> display value.

Example: SAMP:COUN 5

VAL2?

>+0.38954687E -4

>+0.32764551E -4

> etc, for 5 counts.

Queries 5 counts of stored samples from the 2<sup>nd</sup> display.

---

**ROUTe:TERMinate?**

Indicates which input terminals are selected on the RSDM-9061 front panel Front/Rear switch. This switch is not programmable; this query reports the position of the switch, but cannot change it.

Return parameter: FRON | REAR

●On the RSDM-9060, this query always returns FRON.

---

**TIME:SYNC:SERVer**

Sets the server source for time sync of the 2nd group.

Parameter: "<server>", max length = 22 characters.

Example: TIME:SYNC:SERV "time-nv.nist.gov"

---

**TIME:SYNC:SERVer?**

Returns the server source for time sync of the 2nd group.

Return parameter: "<server>", Ex: "time-nv.nist.gov"

---

## CALCulate Commands

---

### CALCulate:CLEAr[:IMMEDIATE]

Clears all of the compare results, statistic calculation value, histogram calculation value, and measurement value.

Parameter: <None>

Example: CALC:CLE:IMM

---

### CALCulate:DATA?

Returns uncalculated original measurement.

---

### CALCulate:FUNCTion

Sets the Advanced function.

Parameter: OFF | HOLD | DB | DBM | LIM | MXB | INV | REF

Example: CALC:FUNC DB

Sets the Advanced function to DB mode

---

### CALCulate:FUNCTion?

Returns the current Advanced function.

Return parameter: OFF | HOLD | DB | DBM | LIM | MXB | INV | REF

---

### CALCulate:HOLD:REFerence

Sets the percentage threshold for the Hold function.

Parameter: <NRf> (0.01, 0.1, 1, 10)

Example: CALC:HOLD:REF 10

Sets the hold percentage to 10%.

---

### CALCulate:HOLD:REFerence?

Returns the percentage threshold from the Hold function.

Return parameter: 0.01 | 0.1 | 1 | 10

---

### CALCulate:STATe

Turns the Advanced function on/off.

Parameter: 0 | 1 | ON | OFF

Example: CALC:STAT OFF

Turns the Advanced function off.

---

### CALCulate:STATe?

Returns the status of the Advanced function.

Return Parameter: 0 | 1, 1=ON, 0=OFF

---

### CALCulate:AVERAge:ALL?

Returns all of the statistic calculation values.

Return parameter: average, standard deviation, minimum, maximum values.

---

---

CALCulate:AVERage:AVERage?

Returns the average value.

Return parameter: <NRf>

---

CALCulate:AVERage:CLEar[:IMMEDIATE]

Clears all of the statistic calculation values.

Parameter: <None>

Example: CALC:AVER:CLE:IMM

---

CALCulate:AVERage:COUNT?

Returns the total count of statistic.

Return parameter: <NRf>

---

CALCulate:AVERage:MAXimum?

Returns the maximum value.

Return parameter: <NRf>

---

CALCulate:AVERage:MINimum?

Returns the minimum value.

Return parameter: <NRf>

---

CALCulate:AVERage:PTPeak?

Returns the peak to peak value (max value – min value).

Return parameter: <NRf>

---

CALCulate:AVERage:SDEVIation?

Returns the Standard Deviation value.

Return parameter: <NRf>

---

CALCulate:AVERage[:STATe]

Turns the statistic calculation function on/off.

Parameter: 0 | 1 | ON | OFF

Example: CALC:AVER:STAT ON

Turns the statistic calculation function on.

---

CALCulate:AVERage[:STATe]?

Returns the statistic calculation function state.

Return parameter: 0 | 1, 1=ON, 0=OFF

---

CALCulate:LIMit:CLEar[:IMMEDIATE]

Clears compare function result counts

---

CALCulate:LIMit:BEEPer:MODE

Sets the beeper alarm mode of the compare function.

Parameter: OFF | PASS | FAIL

Example: CALC:LIM:BEEP:MODE:PASS

Sets the pass alarm to compare function.

---

CALCulate:LIMit:BEEPer:MODE?

Returns the beeper alarm mode of the compare function.

Return Parameter: OFF | PASS | FAIL

---

---

**CALCulate:LIMit:DATA?**

Returns the low / high fail count of the compare function.

Return Parameter: <NR1>

---

**CALCulate:LIMit:LOWer[:DATA]**

Sets the lower limit value of the compare function.

Parameter: <NRf> (-1.2E+08 ~ 1.2E+08) | MIN | MAX | DEF

Example: CALC:LIM:LOW:DATA -1.0

Sets the lower limit to -1.0

---

**CALCulate:LIMit:LOWer[:DATA]?**

Returns the lower limit value of the compare function.

Return parameter: <NRf>

---

**CALCulate:LIMit:UPPer[:DATA]**

Sets the upper limit value of the compare function.

Parameter: <NRf> (-1.2E+08 ~ 1.2E+08) | MIN | MAX | DEF

Example: CALC:LIM:UPP:DATA 1.0

Sets the upper limit to 1.0

---

**CALCulate:LIMit:UPPer[:DATA]?**

Returns the upper limit value of the compare function.

Return parameter: <NRf>

---

**CALCulate:LIMit[:STATe]**

Sets the status on/off for the compare function.

Parameter: 0 | 1 | ON | OFF

Example: CALC:LIM:STAT 1

Sets the compare function to on.

---

**CALCulate:LIMit[:STATe]?**

Returns the status of the compare function.

---

**CALCulate:DB:REFerence**

Sets the reference value for the dB function.

Parameter: <NRf> | MIN | MAX | DEF

RefMethod:

Voltage: (-1200 ~ 1200 V)

dBm: (-200.0 ~ 200 dBm)

Example: CALC:DB:REF MAX

Sets the reference value for dB measurements to the maximum allowed.

---

**CALCulate:DB:REFerence?**

Returns the reference value from the dB function.

Return parameter: <NRf>

---

---

**CALCulate:DB:REfERENCE:METhod**

Sets the unit of reference value for the dB function.

Parameter: VOLTage | DBM

Example: CALC:DB:REF:METH DBM

Sets the unit to dbm of reference value for dB function.

---

**CALCulate:DB:REfERENCE:METhod?**

Returns the unit of reference value from the dB function.

Return parameter: Voltage | dBm

---

**CALCulate:DBM:REfERENCE**

Sets the resistance value for the dBm function.

Parameter: <NR1> (2, 4, 8, 16, 50, 75, 93, 110, 124, 125, 135, 150, 250, 300, 500, 600, 800, 900, 1000, 1200, 8000) | MIN | MAX | DEF

Example: CALC:DBM:REF MAX

Sets the resistance value for dBm measurements to the maximum allowed.

---

**CALCulate:DBM:REfERENCE?**

Returns the resistance value from the dBm function.

Return parameter: <NRf>

---

**CALCulate:SCALe:REfERENCE:AUTO**

Sets the first measurement as the reference value.

Parameter: 0 | 1 | ON | OFF

Example: CALC:SCAL:REF:AUTO ON

Sets the reference value auto setting on for dB measurement.

---

**CALCulate:SCALe:REfERENCE:AUTO?**

Returns the auto setting status of the dB function.

Return parameter: 0 | 1, 1=ON, 0=OFF

---

**CALCulate:MATH:MMFactor**

Sets the scale factor M for math measurement.

Parameter: <NRf> | MIN | MAX | DEF

Example: CALC:MATH:MMF MIN

Sets the scale factor M to the minimum allowed value.

---

**CALCulate:MATH:MMFactor?**

Returns the scale factor M used in the math measurement.

Return parameter: <NRf>

---

**CALCulate:MATH:MBFactor**

Sets the offset factor B for math measurement.

Parameter: <NRf> | MIN | MAX | DEF

Example: CALC:MATH:MBF MIN

Sets the offset factor B to the minimum allowed value.

---

---

CALCulate:MATH:MBFactor?

Returns the offset factor B used in the math measurement.  
Return parameter: <NRF>

---

CALCulate:MATH:PERCent

Sets the reference value for the Percent function.

Parameter: <NRF> | MIN | MAX | DEF

Example: CALC:MATH:PERC MAX

Sets the reference value for the Percent function to the maximum.

---

CALCulate:MATH:PERCent?

Returns the reference value setting for the Percent function.

Return parameter: <NRF>

---

CALCulate:TCHart[:STATe]

Turns the trend chart function on/off.

Parameter: 0 | 1 | ON | OFF

Example: CALC:TCH:STAT ON

Turns the trend chart function on.

---

CALCulate:TCHart [:STATe]?

Returns the trend chart function state.

Return parameter: 0 | 1, 1=ON, 0=OFF

---

CALCulate:TRANSform:HISTogram[:STATe]

Turns the histogram function on/off.

Parameter: 0 | 1 | ON | OFF

Example: CALC:TRAN:HIST:STAT OFF

Turns the histogram function OFF.

---

CALCulate:TRANSform:HISTogram[:STATe]?

Returns the histogram function state.

Return parameter: 0 | 1, 1=ON, 0=OFF

---

CALCulate:TRANSform:HISTogram:ALL?

Returns all of the histogram calculation values.

Return parameter: lower limit, upper limit, total count and all of the histogram data.

<1> <2> <3> <4>

histogram data: refer to "CALC:TRAN:HIST:DATA"

Example: SAMP:COUN 5

CALC:TRAN:HIST:POIN 100

CALC:TRAN:HIST:STAT ON

INIT

CALC:TRAN:HIST:ALL?

Returns: -1.37201300E-04,-1.17674251E-04,+8,+0.....+0

<1> <2> <3> <4>

---

---

**CALCulate:TRANSform:HISTogram:CLEar[:IMMediate]**

Clears all of the histogram calculation values.

Parameter: <None>

Example: CALC:TRAN:HIST:CLE:IMM

---

**CALCulate:TRANSform:HISTogram:COUNT?**

Returns the total counts of histogram function.

Return parameter: <NR1>, Ex: +125

---

**CALCulate:TRANSform:HISTogram:DATA?**

Returns all of the histogram data.

Return parameter: low than lower limit count, histogram data  
and high than upper limit count.

<1>                      <2>                      <3>

Example: SAMP:COUN 5

        CALC:TRAN:HIST:POIN 100

        CALC:TRAN:HIST:STAT ON

        INIT

        CALC:TRAN:HIST:DATA?

Returns: +0,+0,+0,+0,+0,+0,+1,+1,+1,+1.....+0

<1> <2>                      <3>

---

**CALCulate:TRANSform:HISTogram:POINTS**

Sets the number of bins between the lower and upper range values for the histogram.

Parameter: <NR1> (10, 20, 40, 100, 200, 400) | MIN | MAX | DEF

Example: CALC:TRAN:HIST:POIN MAX

Sets the number of bins for the histogram to the maximum allowed.

---

**CALCulate:TRANSform:HISTogram:POINTS?**

Returns the number of bins for the histogram.

Return parameter: +10 | +20 | +40 | +100 | +200 | +400.

---

**CALCulate:TRANSform:HISTogram:RANGe:AUTO**

Turns the auto setting on/off of the histogram's lower and upper range values.

Parameter: 0 | 1 | ON | OFF

Example: CALC:TRAN:HIST:RANG:AUTO OFF

Turns the auto setting off of the histogram's lower and upper range values.

---

**CALCulate:TRANSform:HISTogram:RANGe:AUTO?**

Returns the auto setting state of the histogram's lower and upper range values.

Return parameter: 0 | 1, 1=ON, 0=OFF.

---



---

#### CALCulate:TRANSform:HISTogram:RANGe:LOWer

Sets the lower range value of the histogram function.

Parameter: <NRf> (-1.0E+15 ~ 1.0E+15) | MIN | MAX | DEF

Example: CALC:TRAN:HIST:RANG:LOW -0.5

Sets the lower range value to -0.5.

---

#### CALCulate:TRANSform:HISTogram:RANGe:LOWer?

Returns the lower range value of the histogram function.

Return parameter: <NRf>

---

#### CALCulate:TRANSform:HISTogram:RANGe:UPPer

Sets the upper range value of the histogram function.

Parameter: <NRf> (-1.0E+15 ~ 1.0E+15) | MIN | MAX | DEF

Example: CALC:TRAN:HIST:RANG:UPP 1.0

Sets the upper range value to 1.0

---

#### CALCulate:TRANSform:HISTogram:RANGe:UPPer?

Returns the upper range value of the histogram function.

Return parameter: <NRf>

---

#### CALCulate:TRANSform:HISTogram[:STATe]

Turns the histogram function on/off.

Parameter: 0 | 1 | ON | OFF

Example: CALC:TRAN:HIST:STAT OFF

Turns the histogram function OFF.

---

#### CALCulate:TRANSform:HISTogram[:STATe]?

Returns the histogram function state.

Return parameter: 0 | 1, 1=ON, 0=OFF

---

## CONFigure Commands

---

### CONFigure?

Return current function, range and resolution.

Example: CONF:VOLT:DC 10,MIN

CONF?

Rereuns: "VOLT +1.00000000E+01,+1.00000000E-05".

---

### CONFigure[:VOLTage]:DC

Sets measurement to DC Voltage on the 1<sup>st</sup> display and specifies range/resolution.

Parameter: [None] | [Range(<NRf> | AUTO | MIN | MAX | DEF)], [Resolution(<NRf> | MIN | MAX | DEF)]

Example: CONF:VOLT:DC 1,MAX

Sets the voltage range to 1V and the resolution to the maximum.

●Autoranging (AUTO or DEFault), will generate an error if you

---

specify a <resolution> because the instrument cannot accurately resolve the integration time (especially if the input continuously changes). If your application requires autoranging, specify DEFault for the <resolution> or omit the <resolution> altogether.

---

#### CONFigure[:VOLTage][:DC]:RATio

Sets measurement to DCV ratio mode on the 1<sup>st</sup> display and specifies range/resolution.

Parameter: [None] | [Range(<NRf> | AUTO | MIN | MAX | DEF)],Resolution(<NRf> | MIN | MAX | DEF)]

Example: CONF:VOLT:DC:RAT 1

Sets the DC voltage range to 1V using the default resolution.

●Autoranging (AUTO or DEFault), will generate an error if you specify a <resolution> because the instrument cannot accurately resolve the integration time (especially if the input continuously changes). If your application requires autoranging, specify DEFault for the <resolution> or omit the <resolution> altogether.

---

#### CONFigure[:VOLTage]:AC

Sets measurement to AC Voltage on the 1<sup>st</sup> display and specifies range.

Parameter: [None] | [Range(<NRf> | AUTO | MIN | MAX | DEF)]

Example: CONF:VOLT:AC

Sets the AC voltage range to auto range.

---

#### CONFigure:CURRent[:DC]

Sets measurement to DC Current on the 1<sup>st</sup> display and specifies range/resolution.

Parameter: [None] | [Range(<NRf> | AUTO | MIN | MAX | DEF)],Resolution(<NRf> | MIN | MAX | DEF)]

Example: CONF:CURR:DC 10e-3,DEF

Sets the DC current range to 10mA using the default resolution.

●Autoranging (AUTO or DEFault), will generate an error if you specify a <resolution> because the instrument cannot accurately resolve the integration time (especially if the input continuously changes). If your application requires autoranging, specify DEFault for the <resolution> or omit the <resolution> altogether.

---

---

### CONFigure:CURRent:AC

Sets measurement to AC Current on the 1<sup>st</sup> display and specifies range.

Parameter: [None] | [Range(<NRF> | AUTO | MIN | MAX | DEF)]

Example: CONF:CURR:AC 10e-2

Sets the measurement mode to AC Current with a 100mA range.

---

### CONFigure:RESistance

Sets measurement to 2-wire Resistance on the 1<sup>st</sup> display and specifies range/resolution.

Parameter: [None] | [Range(<NRF> | AUTO | MIN | MAX | DEF)][,Resolution(<NRF> | MIN | MAX | DEF)]

Example: CONF:RES 10e3,MIN

Sets the measurement mode to 2-wire Resistance with a 10kΩ range at the lowest resolution.

- Autoranging (AUTO or DEFault), will generate an error if you specify a <resolution> because the instrument cannot accurately resolve the integration time (especially if the input continuously changes). If your application requires autoranging, specify DEFault for the <resolution> or omit the <resolution> altogether.

---

### CONFigure:FRESistance

Sets measurement to 4-wire Resistance on the 1<sup>st</sup> display and specifies the range/resolution.

Parameter: [None] | [Range(<NRF> | AUTO | MIN | MAX | DEF)][,Resolution(<NRF> | MIN | MAX | DEF)]

Example: CONF:FRES 1e3,MAX

Sets the measurement mode to 4-wire Resistance with a range of 1kΩ at the maximum resolution.

- Autoranging (AUTO or DEFault), will generate an error if you specify a <resolution> because the instrument cannot accurately resolve the integration time (especially if the input continuously changes). If your application requires autoranging, specify DEFault for the <resolution> or omit the <resolution> altogether.

---

---

**CONFigure:FREQuency**

Sets measurement to Frequency on the 1<sup>st</sup> display and specifies range.

Parameter: [None] | [Range(<NRF> | AUTO | MIN | MAX | DEF),Resolution(<NRF> | MIN | MAX | DEF)]

Example: CONF:FREQ MIN:MAX

Sets the frequency range to max.

---

**CONFigure:PERiod**

Sets measurement to Period on the 1<sup>st</sup> display and specifies range/resolution.

Parameter: [None] | [Range(<NRF> | AUTO | MIN | MAX | DEF),Resolution(<NRF> | MIN | MAX | DEF)]

Example: CONF:PER AUTO,MAX

Sets the measurement mode to period with a auto range.

---

**CONFigure:CAPacitance**

Sets measurement to Capcitanace on the 1<sup>st</sup> display and specifies range.

Parameter: [None] | [Range(<NRF> | AUTO | MIN | MAX | DEF),]

Example: CONF:CAP 10e-7

Sets the Capcitanace range to 100nF.

---

**CONFigure:CONTInuity**

Sets measurement to Continuity on the 1<sup>st</sup> display.

Parameter: [None]

---

**CONFigure:DIODE**

Sets measurement to Diode on the 1<sup>st</sup> display.

Parameter: [None]

---

**CONFigure:TEMPerature**

Sets measurement to Temperature on the 1<sup>st</sup> display and specifies type/resolution.

Parameter: [None] | [Probe type [, Type [, 1 [, Resolution(<NRF> | MIN | MAX | DEF)]]]]

<Probe type>:TCouple, RTD, FRTD, THERmistor, FTHermistor.

<Type>:

Tcouple: J | K | N | R | S | T | B | E | USER

RTD / FRTD : PT100 | D100 | F100 | PT385 | PT3916 | USER

Thermistor / Fthermistor : 2.2kΩ | 5kΩ | 10kΩ | USER

Example: CONF:TEMP TCO,K

Sets the measurement mode to TCO with a type K sensor.

- Autoranging (AUTO or DEFault), will generate an error if you specify a <resolution> because the instrument cannot accurately resolve the integration time (especially if the input

---

---

continuously changes). If your application requires autoranging, specify DEFault for the <resolution> or omit the <resolution> altogether.

---

## Secondary Display: CONFigure2 Commands

---

### CONFigure2[:VOLTage]:DC

Sets measurement to DC Voltage on the 2<sup>nd</sup> display and specifies range/resolution.

Parameter: [None] | [Range(<NRf> | AUTO | MIN | MAX | DEF)][,Resolution(<NRf> | MIN | MAX | DEF)]

Example: CONF2:VOLT:DC 1,MAX

Sets the voltage range to 1 volt and the resolution to the maximum.

●Autoranging (AUTO or DEFault), will generate an error if you specify a <resolution> because the instrument cannot accurately resolve the integration time (especially if the input continuously changes). If your application requires autoranging, specify DEFault for the <resolution> or omit the <resolution> altogether.

---

### CONFigure2[:VOLTage]:AC

Sets measurement to AC Voltage on the 2<sup>nd</sup> display and specifies range.

Parameter: [None] | [Range(<NRf> | AUTO | MIN | MAX | DEF)]

Example: CONF2:VOLT:AC

Sets the measurement mode to AC voltage on the 2<sup>nd</sup> display.

---

### CONFigure2:CURREnt[:DC]

Sets measurement to DC Current on the 2<sup>nd</sup> display and specifies range/resolution.

Parameter: [None] | [Range(<NRf> | AUTO | MIN | MAX | DEF)][,Resolution(<NRf> | MIN | MAX | DEF)]

Example: CONF2:CURR:DC 10e-3,DEF

Sets the DC current range to 10mA using the default resolution on the 2<sup>nd</sup> display.

●Autoranging (AUTO or DEFault), will generate an error if you specify a <resolution> because the instrument cannot accurately resolve the integration time (especially if the input continuously changes). If your application requires autoranging, specify DEFault for the <resolution> or omit the <resolution> altogether.

---

---

**CONFigure2:CURRent:AC**

Sets measurement to AC Current on the 2<sup>nd</sup> display and specifies range.

Parameter: [None] | [Range(<NRf> | AUTO | MIN | MAX | DEF)]

Example: CONF2:CURR:AC 10e-2

Sets the measurement mode to AC Current with a 100mA range on the 2<sup>nd</sup> display.

---

**CONFigure2:FREQuency**

Sets measurement to Frequency on the 2<sup>nd</sup> display and specifies range.

Parameter: [None] | [Range(<NRf> | AUTO | MIN | MAX | DEF)],Resolution(<NRf> | MIN | MAX | DEF)]

Example: CONF2:FREQ MAX

Sets the frequency range to max on the 2<sup>nd</sup> display.

---

**CONFigure2:PERiod**

Sets measurement to Period on the 2<sup>nd</sup> display and specifies the range.

Parameter: [None] | [Range(<NRf> | AUTO | MIN | MAX | DEF)],Resolution(<NRf> | MIN | MAX | DEF)]

Example: CONF2:PER

Sets the measurement mode to period measurement using the auto range on the 2<sup>nd</sup> display.

---

**CONFigure2:OFF**

Turns the 2<sup>nd</sup> display function off.

Parameter: [None]

---

## DATA Commands

---

**DATA[X]:LAST?**

Returns the last measurement value with units taken. You can execute this query at any time, even during a series of measurements.

X = null or 1 indicate 1<sup>st</sup> display value, X = 2 indicate 2<sup>nd</sup> display value

Return parameter: <NRf>, Ex: +0.15900000E+01 VDC

● If no data is available, +9.91000000E+37 (Not a Number) is returned with units

---

---

### DATA:POINts?

Returns the total number of measurements currently in reading memory.

Return parameter: <NR1>, Ex: +100

- You can store up to 10,000 measurements values in the reading memory of the RSDM-9060 or 100,000 measurements values on the RSDM-9061.

---

### DATA:POINts:EVENT:THReshold

Sets the threshold for event number of measurement.

Parameter: <NR1> RSDM-9060 : 1-10,000 / RSDM-9061 : 1-100,000

Example: DATA:POIN:EVEN:THR 10

Sets the event threshold to 10.

- When measurement numbers reach the set threshold, the Bit9 within the Operator Event Register (STATus:OPERation:EVENT.) will be set as 1.
- Once the Memory Threshold bit (bit 9 in the Standard Operation Event register) is set, it remains set until cleared by STATus:OPERation:EVENT? or \*CLS.

---

### DATA:POINts:EVENT:THReshold?

Returns the event threshold number.

Return parameter: <NR1>, Ex: +10

---

### DATA:REMOve? <reading\_number>,[WAIT]

Reads and erases measurement values from reading memory up to the specified <reading\_number>.

The measurement values are read and erased from the reading memory starting with the oldest measurement first.

Ex:SAMP:COUN 10

INIT

DATA :REM? 4

Returns: -1.12816521E-04,-1.13148354E-04,-1.13485152E-04,-1.13365632E-04

- If you do not specify a value for <reading\_number>, +9.91000000E+37 (Not a Number) is returned.
  - If reading\_number is greater than the latest counts of measurement, it will return the error. However, it will return data if reading\_number of counts of measurement reach the set threshold only when WAIT parameter is specified.
  - The R? and DATA:REMOve? queries can be used during a long series of readings to periodically remove readings from memory that would normally cause the reading memory to overflow. R? does not wait for all readings to complete. It sends
-

---

the readings that are complete at the time the instrument receives the command.

---

## DIGital INTerface Commands

---

### DIGital:INTerface:MODE

Sets the application mode of digital I/O (Remote Control Only).

Parameter: COMP | 4094 | IO

Example: DIG:INT:MDOE IO

Sets the digital I/O to IO mode.

---

### DIGital:INTerface:MODE?

Returns the digital I/O mode.

Return parameter: COMP | 4094 | IO

---

### DIGital:INTerface:DATA:OUTPut

When the 4094 mode (serial to parallel) is selected for digital I/O, make use of this command to set output status.

Parameter: <NR1> (0-255), <Boolean> (0 | 1) / (serial input data, strobe pulse)

Example: DIG:INT:MDOE 4094

DIG:INT:DATA:OUPT 10,1

---

### DIGital:INTerface:DATA:SETup

When the IO mode is selected for digital I/O, make use of this command to set output status.

Parameter: <Boolean> (0 | 1) / (OUT1, OUT2, OUT3, OUT4)

Example: DIG:INT:MDOE IO

DIG:INT:DATA:SET 0,1,0,1

---

Sets OUT1 to low, OUT2 to high, OUT3 to low, OUT4 to high,

---

## DISPlay Commands

---

### DISPlay[:]STATe]

Sets TFT LCD display screen on/off.

Parameter: 0 | 1 | ON | OFF

Example: DISP OFF

Turns the TFT LCD display screen OFF.

---

### DISPlay[:]STATe]?

Returns the TFT LCD display screen state.

Return parameter: 0 | 1, 0=OFF, 1=ON

---



---

#### DISPlay:TEXT:CLEar

Clears the text message from the display.

- With DISP:STAT ON, DISP:TEXT:CLE returns the display to its normal mode.
  - With DISP:STAT OFF, DISP:TEXT:CLE clears the message and the display remains disabled. To enable the display, send DISPLAY ON or press the front panel Shift key (Local).
- 

#### DISPlay:TEXT[:DATA]

Sets the text message to TFTLCD display screen.

Parameter: "<message>"

Example: DISP:TEXT:DATA "testing"

Prints the testing characters to TFT LCD display screen.

---

#### DISPlay:TEXT[:DATA]?

Returns the text message of TFT LCD display screen.

Return parameter: "<message>", Ex: "testing"

---

#### DISPlay:VIEW

Sets the display form of measured value.

Parameter: NUMeric | HISTogram | TCHart | METer

Example: DISP:VIEW HIST

Sets display in the histogram mode.

---

#### DISPlay:VIEW?

Returns the display form of measured value.

Return parameter: NUM | HIST | TCH | MET

---

## MEASure Commands

---

#### MEASure[:VOLTage]:DC?

Returns the DC voltage measurement value on the 1<sup>st</sup> display.

Parameter: [None] | [Range(<NRf> | AUTO | MIN | MAX | DEF)], [Resolution(<NRf> | MIN | MAX | DEF)]

Example: MEAS:VOLT:DC? MIN

> +6.64925206E-04

Returns the DC voltage measurement value as 0.6649 mV.

- Autoranging (AUTO or DEFault), will generate an error if you specify a <resolution> because the instrument cannot accurately resolve the integration time (especially if the input continuously changes). If your application requires autoranging, specify DEFault for the <resolution> or omit the <resolution> altogether.

### MEASure[:VOLTage][:DC]:RATio?

Returns the DC ratio measurement value on the 1<sup>st</sup> display.

Parameter: [None] | [Range(<NRf> | AUTO | MIN | MAX | DEF)],Resolution(<NRf> | MIN | MAX | DEF)]

Example: MEAS:VOLT:DC:RAT?

> +2.87393920E-03

Returns the DC ratio measurement value as 2.87393 m.

- Autoranging (AUTO or DEFault), will generate an error if you specify a <resolution> because the instrument cannot accurately resolve the integration time (especially if the input continuously changes). If your application requires autoranging, specify DEFault for the <resolution> or omit the <resolution> altogether.

---

### MEASure[:VOLTage]:AC?

Returns the AC voltage measurement value on the 1<sup>st</sup> display.

Parameter: [None] | [Range(<NRf> | AUTO | MIN | MAX | DEF)]

Example: MEAS:VOLT:AC?

> +1.34567684E-04

Returns the AC voltage measurement value as 0.134 mV.

---

### MEASure:CURRent[:DC]?

Returns the DC current measurement value on the 1<sup>st</sup> display.

Parameter: [None] | [Range(<NRf> | AUTO | MIN | MAX | DEF)],Resolution(<NRf> | MIN | MAX | DEF)]

Example: MEAS:CURR:DC? 0.1

> -1.09750431E-07

Returns the DC current measurement value as -0.1097  $\mu$ A.

- Autoranging (AUTO or DEFault), will generate an error if you specify a <resolution> because the instrument cannot accurately resolve the integration time (especially if the input continuously changes). If your application requires autoranging, specify DEFault for the <resolution> or omit the <resolution> altogether.

---

### MEASure:CURRent:AC?

Returns the AC current measurement value on the 1<sup>st</sup> display.

Parameter: [None] | [Range(<NRf> | AUTO | MIN | MAX | DEF)]

Example: MEAS:CURR:AC?

> +1.46445157E-07

Returns the AC current measurement value as 0.000146 mA.

---

---

### MEASure:RESistance?

Returns the 2-wire resistance measurement value on the 1<sup>st</sup> display.

Parameter: [None] | [Range(<NRF> | AUTO | MIN | MAX | DEF)],Resolution(<NRF> | MIN | MAX | DEF)]

Example: MEAS:RES? 1,MIN

> +1.18137284E+06

Sets measurement mode to 2-wire resistance with a range of 1Ω at the minimum resolution and return measurement value.

- Autoranging (AUTO or DEFault), will generate an error if you specify a <resolution> because the instrument cannot accurately resolve the integration time (especially if the input continuously changes). If your application requires autoranging, specify DEFault for the <resolution> or omit the <resolution> altogether.

---

### MEASure:FRESistance?

Returns the 4-wire resistance measurement value on the 1<sup>st</sup> display.

Parameter: [None] | [Range(<NRF> | AUTO | MIN | MAX | DEF)],Resolution(<NRF> | MIN | MAX | DEF)]

Example: MEAS:FRES?

> +1.18134472E+06

Sets measurement mode to 4-wire resistance to auto range and return measurement value.

- Autoranging (AUTO or DEFault), will generate an error if you specify a <resolution> because the instrument cannot accurately resolve the integration time (especially if the input continuously changes). If your application requires autoranging, specify DEFault for the <resolution> or omit the <resolution> altogether.

---

### MEASure:FREQuency?

Returns the frequency measurement value on the 1<sup>st</sup> display.

Parameter: [None] | [Range(<NRF> | AUTO | MIN | MAX | DEF)],Resolution(<NRF> | MIN | MAX | DEF)]

Example: MEAS:FREQ?

> +0.21504529E+05

Returns the frequency measurement value as 21.5 kHz.

---

---

**MEASure:PERiod?**

Returns the period measurement value on the 1<sup>st</sup> display.

Parameter: [None] | [Range(<NRf> | AUTO | MIN | MAX | DEF)], Resolution(<NRf> | MIN | MAX | DEF)]

Example: MEAS:PER? MAX

Returns the period measurement value at the maximum range.

---

**MEASure:CAPacitance**

Returns the capacitance measurement value on the 1<sup>st</sup> display

Parameter: [None] | [Range(<NRf> | AUTO | MIN | MAX | DEF)]

Example: MEAS:CAP?

Returns the capacitance measurement value.

---

**MEASure:CONTinuity?**

Returns the continuity measurement value on the 1<sup>st</sup> display.

Example: MEAS:CONT?

Returns the continuity measurement value.

---

**MEASure:DIODe?**

Returns the diode measurement value on the 1<sup>st</sup> display.

Example: MEAS:DIOD?

Returns the diode measurement value.

---

**MEASure:TEMPerature?**

Returns the temperature measurement value with the selected probe and type on the 1<sup>st</sup> display.

Parameter: [None] | [Probe type [, Type [, 1 [, Resolution(<NRf> | MIN | MAX | DEF)]]]]

< Probe type >:

TCouple | RTD | FRTD | THERmistor | FTHERmistor

<Type>:

Tcouple: J | K | N | R | S | T | B | E

RTD / FRTD : PT100 | D100 | F100 | PT385 | PT3916 | USER

Thermistor / Fthermistor : 2.2k $\Omega$  | 5k $\Omega$  | 10k $\Omega$  | USER

Example: MEAS:TEMP? TCO,K

> +0.26561348E+02

Returns the temperature measurement value.

- Autoranging (AUTO or DEFault), will generate an error if you specify a <resolution> because the instrument cannot accurately resolve the integration time (especially if the input continuously changes). If your application requires autoranging, specify DEFault for the <resolution> or omit the <resolution> altogether.

---

## Secondary Display: MEASure2 Commands

---

### MEASure2[:VOLTage]:DC?

Returns the DC voltage measurement value on the 2<sup>nd</sup> display.

Parameter: [None] | [Range(<NRf> | AUTO | MIN | MAX | DEF)], [Resolution(<NRf> | MIN | MAX | DEF)]

Example: MEAS2:VOLT:DC? 1,MIN

> +4.88519457E-04

Returns the DC voltage measurement value as 0.000488 V.

●Autoranging (AUTO or DEFault), will generate an error if you specify a <resolution> because the instrument cannot accurately resolve the integration time (especially if the input continuously changes). If your application requires autoranging, specify DEFault for the <resolution> or omit the <resolution> altogether.

---

### MEASure2[:VOLTage]:AC?

Returns the AC voltage measurement value on the 2<sup>nd</sup> display.

Parameter: [None] | [Range(<NRf> | AUTO | MIN | MAX | DEF)]

Example: MEAS2:VOLT:AC? MIN

> +5.11895142E-04

Returns the AC voltage measurement value as 0.5118 mV.

---

### MEASure2:CURRent[:DC]?

Returns the DC current measurement value on the 2<sup>nd</sup> display.

Parameter: [None] | [Range(<NRf> | AUTO | MIN | MAX | DEF)], [Resolution(<NRf> | MIN | MAX | DEF)]

Example: MEAS2:CURR:DC? 1E-4

> -1.05580457E-07

Returns the DC current measurement value as -0.1055  $\mu$ A.

●Autoranging (AUTO or DEFault), will generate an error if you specify a <resolution> because the instrument cannot accurately resolve the integration time (especially if the input continuously changes). If your application requires autoranging, specify DEFault for the <resolution> or omit the <resolution> altogether.

---

### MEASure2:CURRent:AC?

Returns the AC current measurement value on the 2<sup>nd</sup> display.

Parameter: [None] | [Range(<NRf> | AUTO | MIN | MAX | DEF)]

Example: MEAS2:CURR:AC?

> +2.20387154E-07

Returns the AC current measurement value as 0.2203  $\mu$ A.

---

---

**MEASure2:FREQuency?**

Returns the frequency measurement value on the 2<sup>nd</sup> display.

Parameter: [None] | [Range(<NRf> | AUTO | MIN | MAX | DEF)], Resolution(<NRf> | MIN | MAX | DEF)]

Example: MEAS2:FREQ?

> +0.21501429E+05

Returns the frequency measurement value as 21.5kHz.

---

**MEASure2:PERiod?**

Returns the period measurement value on the 2<sup>nd</sup> display.

Parameter: [None] | [Range(<NRf> | AUTO | MIN | MAX | DEF)], Resolution(<NRf> | MIN | MAX | DEF)]

Example: MEAS2:PER? MAX

Returns the period measurement value at the maximum range.

---

## SENSe Related Commands

---

**[SENSe:]FUNctIon[X]**

Sets the function for the 1<sup>st</sup> or 2<sup>nd</sup> display, which X = 1 indicate 1<sup>st</sup> display, X = 2 indicate 2<sup>nd</sup> display

Parameter:

(1<sup>st</sup>): "VOLT[:DC]", "VOLT:AC", "CURR[:DC]", "CURR:AC", "RES", "FRES", "FREQ", "PER", "TEMP:TCO", "TEMP:RTD", "TEMP:FRTD", "TEMP:THER", "TEMP:FTH", "CAP", "DIOD", "CONT"

(2<sup>nd</sup>): "VOLT[:DC]", "VOLT:AC", "CURR[:DC]", "CURR:AC", "FREQ", "PER", "NON"

Example: SENS:FUNCI "VOLT:DC"

Sets the 1<sup>st</sup> display to the DCV function.

---

**[SENSe:]FUNctIon[X]?**

Returns the function displayed on the 1<sup>st</sup> or 2<sup>nd</sup> display, which X = 1 indicate 1<sup>st</sup> display, X = 2 indicate 2<sup>nd</sup> display

Return parameter:

(1<sup>st</sup>): "VOLT", "VOLT:AC", "CURR", "CURR:AC", "RES", "FRES", "FREQ", "PER", "TEMP", "CAP", "DIOD", "CONT"

(2<sup>nd</sup>): "VOLT", "VOLT:AC", "CURR", "CURR:AC", "FREQ", "PER", "NON"

---

**[SENSe:]DATA?**

Returns the auxiliary measurement value.

---

---

[SENSe:]DIGital:SHIFt

Sets the digital shift function on or off.

Parameter: 0 | 1 | ON | OFF

Example: SENS:DIG:SHIF ON

Turn the digital shift function on.

---

[SENSe:]DIGital:SHIFt?

Returns the digital shift function status.

Return parameter: 0 | 1 ,1=AUTO, 0=User selected

---

[SENSe:]UNIT

Sets the temperature unit.

Parameter: C | F | K

Example: SENS:UNIT C

Sets the temperature unit to °C.

---

[SENSe:]UNIT?

Returns the temperature unit.

Return parameter: C | F | K

---

## SENSe AVERage Commands

---

[SENSe:]AVERage:COUNT[X]

Sets the digital filter count, which X = 1 indicate 1<sup>st</sup> display, X = 2 indicate 2<sup>nd</sup> display.

Parameter: <NR1> (2 ~ 100) | MIN | MAX | DEF

Example: SENS:AVER:COUN 100

Sets 2<sup>nd</sup> display digital filter count number to 100.

---

[SENSe:]AVERage:COUNT[X]?

Returns the digital filter count.

Return parameter: <NR1>, Ex: +002

---

[SENSe:]AVERage:STATe[X]

Turns the digital filter function On/Off, which X = 1 indicate 1<sup>st</sup> display, X = 2 indicate 2<sup>nd</sup> display.

Parameter: 0 | 1 | ON | OFF

Example: SENS:AVER:STAT ON

Turns 1<sup>st</sup> display digital filter function on.

●If NPLC >= 7.2k/s, the filter function will be disabled.

---

[SENSe:]AVERage:STATe[X]?

Returns the state of the digital filter function (on or off).

Return parameter: 0 | 1, 0=OFF, 1=ON

---

[SENSe:]AVERAge:TCONtrol[X]

Selects the digital filter type, which X = 1 indicate 1<sup>st</sup> display, X = 2 indicate 2<sup>nd</sup> display.

Parameter: MOV | REP

Example: SENS:AVER:TCON MOV

Sets 1<sup>st</sup> display digital filter type to the moving filter.

---

[SENSe:]AVERAge:TCONtrol[X]?

Returns the digital filter type.

Return parameter: MOV (moving) | REP (repeating)

---

[SENSe:]AVERAge:WINDow[X]

Selects a digital filter window, which X = 1 indicate 1<sup>st</sup> display, X = 2 indicate 2<sup>nd</sup> display.

Parameters: 0.01 | 0.1 | 1 | 10 | NONE

Example: SENS:AVER:WIND 0.1

Sets 1<sup>st</sup> display digital filter window to 0.1%

---

[SENSe:]AVERAge:WINDow[X]?

Returns the digital filter window value.

Return parameter: 0.01 | 0.1 | 1 | 10 | NONE

---

[SENSe:]AVERAge:WINDow:METHod[X]

Selects a digital filter window method type, which X = 1 indicate 1<sup>st</sup> display, X = 2 indicate 2<sup>nd</sup> display.

Parameters: Measure | Range

Example: SENS:AVER:WIND: METH Measure

Sets 1<sup>st</sup> display digital filter window method to the measure type

---

[SENSe:]AVERAge:WINDow:METHod[X]?

Returns the digital filter window method type.

Return parameter: Measure | Range

---

## SENSe CAPacitance Commands

---

[SENSe:]CAPacitance:CABLE:CALibratoin

It is used like Relative function before capacitance measurement, (only be used at range 1nF,10nF)

Parameter: [None]

Example: CONF:CAP 1e-9

SENS:CAP:CABL:CAL

Makes test lead to zero before capacitance measurement.

---



---

[SENSe:]CAPacitance:RANGe

Sets the Capacitance measurement range.

Parameter: Range(<NRF> | MIN | MAX | DEF)

Example: SENS:CAP:RANG 1e-9

Sets the capacitance range to 1nF.

---

[SENSe:]CAPacitance:RANGe?

Returns the capacitance measurement range.

---

[SENSe:]CAPacitance:RANGe:AUTO

Sets the Capacitance Auto-range on, off or once only.

Parameter: 0 | 1 | ON | OFF | ONCE

Example: SENS:CAP:RANG:AUTO ON

Turns Auto-range on for capacitance measurements.

---

[SENSe:]CAPacitance:RANGe:AUTO?

Returns the capacitance Auto-range settings.

Return parameter: 0 | 1, 0=OFF, 1=ON

---

## SENSe CONTInuity Commands

---

[SENSe:]CONTInuity:NPLCycles

Sets the integration time for Continuity measurement in PLCs (power line cycles). Where one PLC is equal to 16.6 milliseconds. For any <NRF> parameter, the DMM will automatically set the PLC to the closest acceptable PLC value (0.15 | 0.6 | 1).

Parameter: NPLCycles(<NRF> | MIN | MAX | DEF)

Example: SENS:CONT:NPLC MIN

Sets the integration time to the 0.15 PLCs for continuity measurement.

---

[SENSe:]CONTInuity:NPLCycles?

Returns the integration time for Continuity measurement in PLCs (power line cycles). Where one PLC is equal to 16.6 milliseconds.

Return parameter: 0.15 | 0.6 | 1

---

[SENSe:]CONTInuity:RESolution

Sets the Continuity measurement resolution. The resolution depends on the rate and range settings.

Parameter: Resolution(<NRF> | MIN | MAX | DEF)

Example: SENS:CONT:RES 0.001

Sets the Continuity resolution to 0.001

---

[SENSe:]CONTInuity:RESolution?

Returns the Continuity measurement resolution.

---

---

[SENSe:]CONTInuity:THRShold

Sets the continuity threshold value in ohms.

Parameter: <NR1> (1 ~ 1000)

Example: SENS:CONT:THR 10

Sets the continuity threshold value to 10Ω

---

[SENSe:]CONTInuity:THRShold?

Returns the continuity threshold value.

Return parameter: <NR1>, Ex: +0010

---

[SENSe:]CONTInuity:TRIGger:DELay

Sets the trigger delay that minimum step is microseconds of Continuity measurement.

Parameter: <NRf>(0 ~ 3600 s) | MIN | MAX | DEF

Example: SENS:CONT:TRIG:DEL 0.0001

Sets the trigger delay time to 100us of Continuity measurement.

---

[SENSe:]CONTInuity:TRIGger:DELay?

Returns the trigger delay time in seconds of Continuity measurement.

Return parameter: <NRf>

---

[SENSe:]CONTInuity:ZERO:AUTO

Sets the auto zero mode to on, off or once only of Continuity measurement.

Parameter: 0 | 1 | ON | OFF | ONCE

Example: SENS:CONT:ZERO:AUTO OFF

Sets the auto zero to off.

---

[SENSe:]CONTInuity:ZERO:AUTO?

Returns the auto zero mode of Continuity measurement.

Return parameter: 0 | 1, 1=ON, 0=OFF

---

## SENSe DIODE Commands

---

[SENSe:]DIODE:NPLCycles

Sets the integration time for Diode measurement in PLCs (power line cycles). Where one PLC is equal to 16.6 milliseconds. For any <NRf> parameter, the DMM will automatically set the PLC to the closest acceptable PLC value (0.15 | 0.6 | 1).

Parameter: NPLCycles(<NRf> | MIN | MAX | DEF)

Example: SENS:DIOD:NPLC DEF

Sets the integration time to the 1 PLCs for diode measurement.

---

---

[SENSe:]DIODe:NPLCycles?

Returns the integration time for Diode measurement in PLCs (power line cycles). Where one PLC is equal to 16.6 milliseconds.

Return parameter: 0.15 | 0.6 | 1

---

[SENSe:]DIODe:RESolution

Sets the Diode measurement resolution. The resolution depends on the rate and range settings.

Parameter: Resolution(<NRf> | MIN | MAX | DEF)

Example: SENS:DIOD:RES 0.1e-4

Sets the Diode resolution to 0.00001

---

[SENSe:]DIODe:RESolution?

Returns the Diode measurement resolution.

---

[SENSe:]DIODe:TRIGger:DELay

Sets the trigger delay that minimum step is microseconds of Diode measurement.

Parameter: <NRf>(0 ~ 3600 s) | MIN | MAX | DEF

Example: SENS:DIOD:TRIG:DEL 0.5

Sets the trigger delay time to 500ms of Diode measurement.

---

[SENSe:]DIODe:TRIGger:DELay?

Returns the trigger delay time in seconds of Diode measurement.

Return parameter: <NRf>

---

[SENSe:]DIODe:ZERO:AUTO

Sets the auto zero mode to on, off or once only of Diode measurement.

Parameter: 0 | 1 | ON | OFF | ONCE

Example: SENS:DIOD:ZERO:AUTO ON

Sets the auto zero to on.

---

[SENSe:]DIODe:ZERO:AUTO?

Returns the auto zero mode of Diode measurement.

Return Parameter: 0 | 1, 1=ON, 0=OFF

---

## SENSe VOLTage Commands

---

[SENSe:]VOLTage[:DC]:IMPedance:AUTO

Sets the Automatic input impedance for DC Voltage measurement.

Parameter: 0 | 1 | ON | OFF

Example: SENS:VOLT:DC:IMP:AUTO ON

Turns the Automatic input impedance on.

---

---

[SENSe:]VOLTage[:DC]:IMPedance:AUTO?

Returns the Automatic input impedance mode.

Return parameter: 0 | 1, 0=OFF, 1=ON

---

[SENSe:]VOLTage[:DC]:NPLCycles

Sets the integration time for DC Voltage measurement in PLCs (power line cycles). Where one PLC is equal to 16.6 milliseconds. For any <NRF> parameter, the DMM will automatically set the PLC to the closest acceptable PLC value (0.006 | 0.0083 | 0.0125 | 0.025 | 0.05 | 0.15 | 0.6 | 1 | 3 | 12).

Parameter: NPLCycles(<NRF> | MIN | MAX | DEF)

Example: SENS:VOLT:DC:NPLC 12

Sets the integration time to 12 PLCs for DC Voltage measurements.

---

[SENSe:]VOLTage[:DC]:NPLCycles?

Returns the integration time for DC Voltage measurement in PLCs (power line cycles). Where one PLC is equal to 16.6 milliseconds.

Return parameter: 0.006 | 0.0083 | 0.0125 | 0.025 | 0.05 | 0.15 | 0.6 | 1 | 3 | 12

---

[SENSe:]VOLTage[:DC]:NULL[:STATe]

Sets the relative function on/off for DC Voltage measurement.

Parameter: 0 | 1 | ON | OFF

Example: SENS:VOLT:DC:NULL:STAT OFF

Turns the relative function off for DC Voltage measurement.

---

[SENSe:]VOLTage[:DC]:NULL[:STATe]?

Returns the relative function state of DC Voltage measurement.

Return parameter: 0 | 1, 0=OFF, 1=ON

---

[SENSe:]VOLTage[:DC]:NULL:VALue

Sets the relative value for DC Voltage measurement.

Parameter: <NRF> (-1200.0~1200.0 V) | MIN | MAX | DEF

Example: SENS:VOLT:DC:NULL:STAT ON

SENS:VOLT:DC:NULL:VAL 1.2

Sets the relative value to 1.2V for DC Voltage measurement.

---

[SENSe:]VOLTage[:DC]:NULL:VALue?

Returns the current relative value of DC Voltage measurement.

---

---

[SENSe:]VOLTage[:DC]:NULL:VALue:AUTO

Sets the relative value auto on/off for DC Voltage measurement.

Parameter: 0 | 1 | ON | OFF

Example: SENS:VOLT:DC:NULL:STAT ON

SENS:VOLT:DC:NULL:VAL:AUTO ON

READ ?

The unit automatically sets the 1st count of measurement as null value.

---

[SENSe:]VOLTage[:DC]:NULL:VALue:AUTO?

Returns the null value auto state of DC Voltage measurement.

---

[SENSe:]VOLTage[:DC]:RANGe

Sets the DC voltage measurement range.

Parameter: <NRf> | MIN | MAX | DEF

Example: SENS:VOLT:DC:RANG MIN

Set the DC voltage range to lowest range allowed.

---

[SENSe:]VOLTage[:DC]:RANGe?

Returns the DC voltage measurement range.

---

[SENSe:]VOLTage[:DC]:RANGe:AUTO

Sets the DC voltage Auto-range setting on, off or once only.

Parameter: 0 | 1 | ON | OFF | ONCE

Example: SENS:VOLT:DC:RANG:AUTO ON

Turns Auto-range on for DC voltage measurements.

---

[SENSe:]VOLTage[:DC]:RANGe:AUTO?

Returns the DC voltage Auto-range settings.

Return parameter: 0 | 1, 0=OFF, 1=ON

---

[SENSe:]VOLTage[:DC]:RESolution

Sets the DC Voltage measurement resolution. The resolution depends on the rate and range settings.

Parameter: Resolution(<NRf> | MIN | MAX | DEF)

Example: SENS:VOLT:DC:RES MAX

Sets the DC Voltage resolution to MAX.

---

[SENSe:]VOLTage[:DC]:RESolution?

Returns the DC Voltage resolution.

---

[SENSe:]VOLTage[:DC]:TRIGger:DELay

Sets the trigger delay that minimum step is microseconds of DC Voltage measurement.

Parameter: <NRf>(0 ~ 3600 s) | MIN | MAX | DEF

Example: SENS:VOLT:DC:TRIG:DEL MAX

Sets the trigger delay time to the maximum of DC Voltage measurement.

---

---

[SENSe:]VOLTage[:DC]:TRIGger:DELAy?

Returns the trigger delay time in seconds of DC Voltage measurement.

Return parameter: <NRf>

---

[SENSe:]VOLTage[:DC]:ZERO:AUTO

Sets the auto zero mode to on, off or once of DC Voltage measurement.

Parameter: 0 | 1 | ON | OFF | ONCE

Example: SENS:VOLT:DC:ZERO:AUTO ONCE

Sets the auto zero to once.

---

[SENSe:]VOLTage[:DC]:ZERO:AUTO?

Returns the auto zero mode of DC Voltage measurement.

Return Parameter: 0 | 1, 1=ON, 0=OFF

---

[SENSe:]VOLTage:AC:BANdwidth

Sets the AC bandwidth (AC filter).

Parameter: <NRf> (3 | 20 | 200) | MIN | MAX | DEF

Example: SENS:VOLT:AC:BANd 20

Sets the AC bandwidth to 20Hz.

---

[SENSe:]VOLTage:AC:BANdwidth?

Returns the AC bandwidth.

Return parameter: <NRf>, Ex: 3.00000000E+00

---

[SENSe:]VOLTage:AC:NULL[:STATe]

Sets the relative function on/off for AC Voltage measurement.

Parameter: 0 | 1 | ON | OFF

Example: SENS:VOLT:AC:NULL:STAT ON

Turns the relative function on for AC Voltage measurements.

---

[SENSe:]VOLTage:AC:NULL[:STATe]?

Returns the relative function state of AC Voltage measurement.

Return parameter: 0 | 1, 0=OFF, 1=ON

---

[SENSe:]VOLTage:AC:NULL:VALue

Sets the relative value for AC Voltage measurement.

Parameter: <NRf> (-1200.0~1200.0 V) | MIN | MAX | DEF

Example: SENS:VOLT:AC:NULL:VAL 1

Sets the relative value to 1V for AC Voltage measurement.

---

[SENSe:]VOLTage:AC:NULL:VALue?

Returns the current relative value of AC Voltage measurement.

---

---

[SENSe:]VOLTage:AC:NULL:VALue:AUTO

Sets the relative value auto on/off for AC Voltage measurement.

Parameter: 0 | 1 | ON | OFF

Example: SENS:VOLT:AC:NULL:STAT ON  
SENS:VOLT:AC:NULL:VAL:AUTO OFF  
READ?

The unit automatically sets the 1st count of measurement as null value.

---

[SENSe:]VOLTage:AC:NULL:VALue:AUTO?

Returns the null value auto state of AC Voltage measurement.

---

[SENSe:]VOLTage:AC:RANGe

Sets the AC voltage measurement range.

Parameter: (<NRf> | MIN | MAX | DEF)

Example: SENS:VOLT:AC:RANG MAX

Set the AC voltage range to highest range allowed.

---

[SENSe:]VOLTage:AC:RANGe?

Returns the AC Voltage measurement range.

---

[SENSe:]VOLTage:AC:RANGe:AUTO

Sets the AC voltage Auto-range setting on, off or once.

Parameter: 0 | 1 | ON | OFF | ONCE

Example: SENS:VOLT:AC:RANG:AUTO ON

Turns Auto-range on for AC voltage measurements.

---

[SENSe:]VOLTage:AC:RANGe:AUTO?

Returns the AC voltage Auto-range settings.

Return parameter: 0 | 1, 0=OFF, 1=ON

---

[SENSe:]VOLTage:AC:TRIGger:DELay

Sets the trigger delay time that minimum step is microseconds of AC Voltage measurement.

Parameter: <NRf>(0 ~ 3600 s) | MIN | MAX | DEF

Example: SENS:VOLT:AC:TRIG:DEL 0.4

Sets the trigger delay time to 400ms of AC Voltage measurement.

---

[SENSe:]VOLTage:AC:TRIGger:DELay?

Returns the trigger delay time in seconds of AC Voltage measurement.

Return parameter: <NRf>

---

## SENSe CURRent Commands

---

[SENSe:]CURRent[:DC]:NPLCycles

Sets the integration time for DC Current measurement in PLCs (power line cycles). Where one PLC is equal to 16.6 milliseconds. For any <Nrf> parameter, the DMM will automatically set the PLC to the closest acceptable PLC value (0.006 | 0.0083 | 0.0125 | 0.025 | 0.05 | 0.15 | 0.6 | 1 | 3 | 12).

Parameter: NPLCycles(<Nrf> | MIN | MAX | DEF)

Example: SENS:CURR:DC:NPLC 1

Sets the integration time to 1 PLCs for DC Current measurement.

---

[SENSe:]CURRent[:DC]:NPLCycles?

Returns the integration time for DC Current measurement in PLCs (power line cycles). Where one PLC is equal to 16.6 milliseconds.

Return parameter: 0.006 | 0.0083 | 0.0125 | 0.025 | 0.05 | 0.15 | 0.6 | 1 | 3 | 12

---

[SENSe:]CURRent[:DC]:NULL[:STATe]

Sets the relative function on/off for DC Current measurement.

Parameter: 0 | 1 | ON | OFF

Example: SENS:CURR:DC:NULL:STAT ON

Turns the relative function on for DC Current measurement.

---

[SENSe:]CURRent[:DC]:NULL[:STATe]?

Returns the relative function state of DC Current measurement.

Return parameter: 0 | 1, 0=OFF, 1=ON

---

[SENSe:]CURRent[:DC]:NULL:VALue

Sets the relative value for DC Current measurement.

Parameter: <Nrf> (-12.0~12.0 A) | MIN | MAX | DEF

Example: SENS:CURR:DC:NULL:VAL 1.1

Sets the relative value to 1.1A for DC Current measurement.

---

[SENSe:]CURRent[:DC]:NULL:VALue?

Returns the current relative value of DC Current measurement.

---



---

[SENSe:]CURRent[:DC]:NULL:VALue:AUTO

Sets the relative value auto on/off for DC Current measurement.

Parameter: 0 | 1 | ON | OFF

Example: SENS:CURR:DC:NULL:STAT ON

SENS:CURR:DC:NULL:VAL:AUTO ON

The unit automatically sets the 1st count of measurement as null value.

---

[SENSe:]CURRent[:DC]:NULL:VALueAUTO?

Returns the null value auto state of DC Current measurement.

---

[SENSe:]CURRent[:DC]:RANGe

Sets the DC current measurement range.

Parameter: Range(<NRf> | MIN | MAX | DEF)

Example: SENS:CURR:DC:RANG 10e-2

Sets the DC current range to 100mA.

---

[SENSe:]CURRent[:DC]:RANGe?

Returns the DC current measurement range.

---

[SENSe:]CURRent[:DC]:RANGe:AUTO

Sets the DC current Auto-range settings on, off or once.

Parameter: 0 | 1 | ON | OFF | ONCE

Example: SENS:CURR:DC:RANG:AUTO OFF

Turns Auto-range off for DC current measurement.

---

[SENSe:]CURRent[:DC]:RANGe:AUTO?

Returns the DC current Auto-range settings.

Return parameter: 0 | 1, 0=OFF, 1=ON

---

[SENSe:]CURRent[:DC]:RESolution

Sets the DC Current measurement resolution. The resolution depends on the rate and range settings.

Parameter: Resolution(<NRf> | MIN | MAX | DEF)

Example: SENS:CURR:DC:RES 0.01

Sets the DC Current resolution to 0.01

---

[SENSe:]CURRent[:DC]:RESolution?

Returns the DC Current resolution.

---

[SENSe:]CURRent[:DC]:TERMinals

Assigns an input port for the current function.

Parameter: <NR1> RSDM-9060 : 3 / RSDM-9061 : 3 | 10

Example: SENS:CURR:DC:TERM 3

Sets the input jack to the 3A current input port.

---

[SENSe:]CURRent[:DC]:TERMinals?

Returns the assigned input port used for the current function.

Return parameter: +3 | +10

---

---

[SENSe:]CURRent[:DC]:TRIGger:DELay
Sets the trigger delay time that minimum step is microseconds of DC Current measurement. Parameter: <NRf>(0 ~ 3600 s)   MIN   MAX   DEF Example: SENS:CURR:DC:TRIG:DEL 2e-4 Sets the trigger delay time to 200us of DC Current measurement.
[SENSe:]CURRent[:DC]:TRIGger:DELay?
Returns the trigger delay time in seconds of DC Current measurement. Return parameter: <NRf>
[SENSe:]CURRent[:DC]:ZERO:AUTO
Sets the auto zero to on, off or once of DC Current measurement. Parameter: 0   1   ON   OFF   ONCE Example: SENS:CURR:DC:ZERO:AUTO ON Sets the auto zero to on.
[SENSe:]CURRent[:DC]:ZERO:AUTO?
Returns the auto zero mode of DC Current measurement. Return Parameter: 0   1, 1=ON, 0=OFF
[SENSe:]CURRent:AC:BANDwidth
Sets the AC current bandwidth (AC filter). Parameter: <NRf> (3   20   200)   MIN   MAX   DEF Example: SENS:CURR:AC:BAND 3 Sets the AC current bandwidth to 3Hz.
[SENSe:]CURRent:AC:BANDwidth?
Returns the AC current bandwidth. Return parameter: <NRf>
[SENSe:]CURRent:AC:NULL[:STATe]
Sets the relative function on/off for AC Current measurement. Parameter: 0   1   ON   OFF Example: SENS:CURR:AC:NULL:STAT ON Turns the relative function on for AC Current measurement.
[SENSe:]CURRent:AC:NULL[:STATe]?
Returns the relative function state of AC Current measurement. Return parameter: 0 1, 0=OFF, 1=ON
[SENSe:]CURRent:AC:NULL:VALue
Sets the relative value for AC Current measurement. Parameter: <NRf> (-12.0~12.0 A)   MIN   MAX   DEF Example: SENS:CURR:AC:NULL:VAL 0.02 Sets the relative value to 0.02A for AC Current measurement.

---

---

[SENSe:]CURRent:AC:NULL:VALue?	Returns the current relative value of AC Current measurement.
[SENSe:]CURRent:AC:NULL:VALue:AUTO	Sets the relative value auto on/off for AC Current measurement. Parameter: 0   1   ON   OFF Example: SENS:CURR:AC:NULL:STAT ON SENS:CURR:AC:NULL:VAL:AUTO ON The unit automatically sets the 1st count of measurement as null value.
[SENSe:]CURRent:AC:NULL:VALue:AUTO?	Returns the null value auto state of AC Current measurement.
[SENSe:]CURRent:AC:RANGe	Sets the AC current measurement range. Parameter: Range(<NRf>   MIN   MAX   DEF) Example: SENS:CURR:AC:RANG 10e-3 Sets the AC current range to 10mA.
[SENSe:]CURRent:AC:RANGe?	Returns the AC current measurement range.
[SENSe:]CURRent:AC:RANGe:AUTO	Sets the AC current Auto-range settings on, off or once. Parameter: 0   1   ON   OFF   ONCE Example: SENS:CURR:AC:RANG:AUTO OFF Turns Auto-range off for AC current measurements.
[SENSe:]CURRent:AC:RANGe:AUTO?	Returns the AC current Auto-range settings. Return parameter: 0   1, 0=OFF, 1=ON
[SENSe:]CURRent:AC:TERMinals	Assigns an input port for the current function. Parameter: <NR1> RSDM-9060 : 3 / RSDM-9061 : 3   10 Example: SENS:CURR:AC:TERM 10 Sets the input jack to the 10A current input port.
[SENSe:]CURRent:AC:TERMinals?	Returns the assigned input port used for the current function. Return Parameter: +3   +10
[SENSe:]CURRent:AC:TRIGger:DELay	Sets the trigger delay time that minimum step is microseconds of AC Current measurement. Parameter: <NRf>(0 ~ 3600 s)   MIN   MAX   DEF Example: SENS:CURR:AC:TRIG:DEL 1 Sets the trigger delay time to 1s of AC Current measurement.

---

---

[SENSe:]CURRent:AC:TRIGger:DELAy?

Returns the trigger delay time in seconds of AC Current measurement.

Return parameter: <NRf>

---

## SENSe RESistance Commands

---

[SENSe:]RESistance:NPLCycles

Sets the integration time for 2-wire resistance measurement in PLCs (power line cycles). Where one PLC is equal to 16.6 milliseconds. For any <NRf> parameter, the DMM will automatically set the PLC to the closest acceptable PLC value (0.006 | 0.0083 | 0.0125 | 0.025 | 0.05 | 0.15 | 0.6 | 1 | 3 | 12).

Parameter: NPLCycles(<NRf> | MIN | MAX | DEF)

Example: SENS:RES:NPLC MIN

Sets the integration time to 0.006 PLCs for 2-wire resistance measurement.

---

[SENSe:]RESistance:NPLCycles?

Returns the integration time for 2-wire resistance measurement in PLCs (power line cycles). Where one PLC is equal to 16.6 milliseconds.

Return parameter: 0.006 | 0.0083 | 0.0125 | 0.025 | 0.05 | 0.15 | 0.6 | 1 | 3 | 12

---

[SENSe:]RESistance:NULL[:STATe]

Sets the relative function on/off for 2-wire resistance measurement.

Parameter: 0 | 1 | ON | OFF

Example: SENS:RES:NULL:STAT ON

Turns the relative function on for 2-wire resistance measurement.

---

[SENSe:]RESistance:NULL[:STATe]?

Returns the relative function state of 2-wire resistance measurement.

Return parameter: 0|1, 0=OFF, 1=ON

---

[SENSe:]RESistance:NULL:VALue

Sets the relative value for 2-wire resistance measurement.

Parameter: <NRf> (-120.0~120.0 M $\Omega$ ) | MIN | MAX | DEF

Example: SENS:RES:NULL:VAL 2

Sets the relative value to 2 $\Omega$  for 2-wire resistance measurements.

---

---

[SENSe:]RESistance:NULL:VALue?

Returns the current relative value of 2-wire resistance measurement.

---

[SENSe:]RESistance:NULL:VALue:AUTO

Sets the relative value auto on/off for 2-wire resistance measurement.

Parameter: 0 | 1 | ON | OFF

Example: SENS:RES:NULL:STAT ON

SENS:RES:NULL:VAL:AUTO OFF

The unit automatically sets the 1st count of measurement as null value.

---

[SENSe:]RESistance:NULL:VALue:AUTO?

Returns the null value auto state of 2-wire resistance measurement.

---

[SENSe:]RESistance:RANGe

Sets the 2-wire resistance measurement range.

Parameter: Range(<NRf> | MIN | MAX | DEF)

Example: SENS:RES:RANG 1000

Sets the 2-wire resistance range to 1k $\Omega$ .

---

[SENSe:]RESistance:RANGe?

Returns the 2-wire resistance measurement range.

---

[SENSe:]RESistance:RANGe:AUTO

Sets the 2-wire resistance Auto-range settings on, off or once.

Parameter: 0 | 1 | ON | OFF | ONCE

Example: SENS:RES:RANG:AUTO ON

Turns Auto-range on for 2-wire resistance measurement.

---

[SENSe:]RESistance:RANGe:AUTO?

Returns the 2-wire resistance Auto-range setting.

Return parameter: 0 | 1, 0=OFF, 1=ON

---

[SENSe:]RESistance:RESolution

Sets the 2-wire resistance measurement resolution. The resolution depends on the rate and range settings.

Parameter: Resolution(<NRf> | MIN | MAX | DEF)

Example: SENS:RES:RES 0.01

Sets the 2-wire resistance resolution to 0.01

---

[SENSe:]RESistance:RESolution?

Returns the 2-wire resistance resolution.

---

---

[SENSe:]RESistance:TRIGger:DELay

Sets the trigger delay time that minimum step is microseconds of 2-wire resistance measurement.

Parameter: <NRf>(0 ~ 3600 s) | MIN | MAX | DEF

Example: SENS:FRES:TRIG:DEL DEF

Sets the trigger delay time to 1s of 2-wire resistance measurement.

---

[SENSe:]RESistance:TRIGger:DELay?

Returns the trigger delay time in seconds of 2-wire resistance measurement.

Return parameter: <NRf>

---

[SENSe:]RESistance:ZERO:AUTO

Sets the auto zero mode to on, off or once of 2-wire resistance measurement.

Parameter: 0 | 1 | ON | OFF | ONCE

Example: SENS:RES:ZERO:AUTO ON

Sets the auto zero to on.

---

[SENSe:]RESistance:ZERO:AUTO?

Returns the auto zero mode of 2-wire resistance measurement.

Return Parameter: 0 | 1, 1=ON, 0=OFF

---

[SENSe:]FRESistance:NPLCycles

Sets the integration time for 4-wire resistance measurement in PLCs (power line cycles). Where one PLC is equal to 16.6 milliseconds. For any <NRf> parameter, the DMM will automatically set the PLC to the closest acceptable PLC value (0.006 | 0.0083 | 0.0125 | 0.025 | 0.05 | 0.15 | 0.6 | 1 | 3 | 12).

Parameter: NPLCycles(<NRf> | MIN | MAX | DEF)

Example: SENS:FRES:NPLC MAX

Sets the integration time to the 12 PLCs for 4-wire resistance measurement.

---

[SENSe:]FRESistance:NPLCycles?

Returns the integration time for 4-wire Resistance measurement in PLCs (power line cycles). Where one PLC is equal to 16.6 milliseconds.

Return parameter: 0.006 | 0.0083 | 0.0125 | 0.025 | 0.05 | 0.15 | 0.6 | 1 | 3 | 12

---

---

[SENSe:]FRESistance:NULL[:STATe]

Sets the relative function on/off for 4-wire resistance measurement.

Parameter: 0 | 1 | ON | OFF

Example: SENS:FRES:NULL:STAT ON

Turns the relative function on for 4-wire resistance measurement.

---

[SENSe:]FRESistance:NULL[:STATe]?

Returns the relative function state of 4-wire resistance measurement.

Return parameter: 0 | 1, 0=OFF, 1=ON

---

[SENSe:]FRESistance:NULL:VALue

Sets the relative value for 4-wire resistance measurement.

Parameter: <NRf> (-120.0~120.0 MΩ) | MIN | MAX | DEF

Example: SENS:FRES:NULL:VAL 2

Sets the relative value to 2Ω for 4-wire resistance measurement.

---

[SENSe:]FRESistance:NULL:VALue?

Returns the current relative value of 4-wire resistance measurement.

---

[SENSe:]FRESistance:NULL:VALue:AUTO

Sets the relative value auto on/off for 4-wire resistance measurement.

Parameter: 0 | 1 | ON | OFF

Example: SENS:FRES:NULL:STAT ON

SENS:FRES:NULL:VAL:AUTO ON

The unit automatically sets the 1st count of measurement as null value.

---

[SENSe:]FRESistance:NULL:VALue:AUTO?

Returns the null value auto state of 4-wire resistance measurement.

---

[SENSe:]FRESistance:RANGe

Sets the 4-wire resistance measurement range.

Parameter: Range(<NRf> | MIN | MAX | DEF)

Example: SENS:FRES:RANG 10e3

Sets the 4-wire resistance range to 10kΩ.

---

[SENSe:]FRESistance:RANGe?

Returns the 4-wire resistance measurement range.

---

---

[SENSe:]FRESistance:RANGe:AUTO

Sets the 4-wire resistance Auto-range settings on, off or once.

Parameter: 0 | 1 | ON | OFF | ONCE

Example: SENS:FRES:RANG:AUTO ON

Turns Auto-range on for 4-wire resistance measurement.

---

[SENSe:]FRESistance:RANGe:AUTO?

Returns the 4-wire resistance Auto-range setting.

Return parameter: 0 | 1, 0=OFF, 1=ON

---

[SENSe:]FRESistance:RESolution

Sets the 4-wire resistance measurement resolution. The resolution depends on the rate and range settings.

Parameter: Resolution(<NRf> | MIN | MAX | DEF)

Example: SENS:FRES:RES 0.01

Sets the 4-wire resistance resolution to 0.01

---

[SENSe:]FRESistance:RESolution?

Returns the 4-wire resistance resolution.

---

[SENSe:]FRESistance:TRIGger:DELay

Sets the trigger delay time that minimum step is microseconds of 4-wire resistance measurement.

Parameter: <NRf> (0 ~ 3600 s) | MIN | MAX | DEF

Example: SENS:RES:TRIG:DEL MIN

Sets the trigger delay time to 0s of 4-wire resistance measurement.

---

[SENSe:]FRESistance:TRIGger:DELay?

Returns the trigger delay time in seconds of 4-wire resistance measurement.

Return parameter: <NRf>

---

[SENSe:]FRESistance:ZERO:AUTO

Sets the auto zero mode to on, off or once of 4-wire resistance measurement.

Parameter: 0 | 1 | ON | OFF | ONCE

Example: SENS:FRES:ZERO:AUTO ON

Sets the auto zero to on.

---

[SENSe:]FRESistance:ZERO:AUTO?

Returns the auto zero mode of 4-wire resistance measurement.

Return Parameter: 0 | 1, 1=ON, 0=OFF

---



## SENSe FREQuency Commands

---

[SENSe:]FREQuency:APERture

Sets the aperture time (gate time) for the frequency function (0.01s, 0.1s, 1s).

Parameter: <NRf> (0.01 | 0.1 | 1)

Example: SENS:FREQ:APER 0.01

Sets the gate time to 0.01 seconds.

---

[SENSe:]FREQuency:APERture?

Returns aperture time (gate time) for the frequency function.

Return parameter: <NRf>

---

[SENSe:]FREQuency:CURRent:RANGe

Sets the frequency measurement range.

Parameter: Range(<NRf> | MIN | MAX | DEF)

Example: SENS:FREQ:CURR:RANG MIN

Sets the frequency to the minimum range.

---

[SENSe:]FREQuency:CURRent:RANGe?

Returns the frequency measurement range.

---

[SENSe:]FREQuency:CURRent:RANGe:AUTO

Sets the Frequency Auto-range settings on, off or once.

Parameter: 0 | 1 | ON | OFF | ONCE

Example: SENS:FREQ:CURR:RANG:AUTO ON

Turns the Auto-range on for the frequency function.

---

[SENSe:]FREQuency:CURRent:RANGe:AUTO?

Returns the frequency Auto-range setting.

Return parameter: 0 | 1, 0=OFF, 1=ON

---

[SENSe:]FREQuency:INPutjack

Assigns an input port for the frequency function.

Parameter: <NR1> (0 | 1 | 2), 0=Voltage, 1=3A, 2=10A

Example: SENS:FREQ:INP 0

Sets the input jack to the Voltage input port.

---

[SENSe:]FREQuency:INPutjack?

Returns the assigned input port used for the frequency function.

Return Parameter: VOLT | 3A | 10A

---

[SENSe:]FREQuency:NULL:STATe]

Sets the relative function on/off for Frequency measurement.

Parameter: 0 | 1 | ON | OFF

Example: SENS:FREQ:NULL:STAT ON

Turns the relative function on for Frequency measurement.

---

---

[SENSe:]FREQuency:NULL[:STATe]?	Returns the relative function state of Frequency measurement. Return parameter: 0   1, 0=OFF, 1=ON
[SENSe:]FREQuency:NULL:VALue	Sets the relative value for Frequency measurement. Parameter: <NRf> (-1.2e6~1.2e6 Hz)   MIN   MAX   DEF Example: SENS:FREQ:NULL:VAL 10 Sets the relative value to 10Hz for Frequency measurement.
[SENSe:]FREQuency:NULL:VALue?	Returns the current relative value of Frequency measurement.
[SENSe:]FREQuency:NULL:VALue:AUTO	Sets the relative value auto on/off for Frequency measurement. Parameter: 0   1   ON   OFF Example: SENS:FREQ:NULL:STAT ON SENS:FREQ:NULL:VAL:AUTO ON The unit automatically sets the 1st count of measurement as null value.
[SENSe:]FREQuency:NULL:VALue:AUTO?	Returns the null value auto state of Frequency measurement.
[SENSe:]FREQuency:TIMEout:AUTO	Assigns timeout time at the frequency measurement. Parameter: 0   1   ON   OFF Example: SENS:FREQ:TIM:AUTO OFF Sets the timeout time at 1 seconds.
[SENSe:]FREQuency:TIMEout:AUTO?	Returns the assigned timeout time used for the frequency function. Return parameter: 0   1, 0:timeout time = 1 second, 1:timeout time is different in according with ac filter bandwidth (gate time).
[SENSe:]FREQuency:TRIGger:DELay	Sets the trigger delay time that minimum step is microseconds of Frequency measurement. Parameter: <NRf> (0 ~ 3600 s)   MIN   MAX   DEF Example: SENS:FREQ:TRIG:DEL 0.5 Sets the trigger delay time to 0.5s of Frequency measurement.
[SENSe:]FREQuency:TRIGger:DELay?	Returns the trigger delay time in seconds of Frequency measurement. Return parameter: <NRf>

---

---

[SENSe:]FREQuency:VOLTage:RANGe

Sets the frequency measurement range.

Parameter: Range(<NRf> | MIN | MAX | DEF)

Example: SENS:FREQ:VOLT:RANG MIN

Sets the frequency to the minimum range.

---

[SENSe:]FREQuency:VOLTage:RANGe?

Returns the frequency measurement range.

---

[SENSe:]FREQuency:VOLTage:RANGe:AUTO

Sets the Frequency Auto-range settings on, off or once.

Parameter: 0 | 1 | ON | OFF | ONCE

Example: SENS:FREQ:VOLT:RANG:AUTO ON

Turns the Auto-range on for the frequency measurement.

---

[SENSe:]FREQuency:VOLTage:RANGe:AUTO?

Returns the Frequency Auto-range setting.

Return parameter: 0 | 1, 0=OFF, 1=ON

---

[SENSe:]PERiod:APERture

Sets the aperture time (gate time) for the period function(0.01s, 0.1s, 1s).

Parameter: <NRf> (0.01 | 0.1 | 1)

Example: SENS:PER:APER 0.1

Sets the gate time to 0.1 seconds for the period function.

---

[SENSe:]PERiod:APERture?

Returns the aperture time (gate time) for the period function.

Return parameter: <NRf>

---

[SENSe:]PERiod:CURRent:RANGe

Sets the frequency measurement range.

Parameter: Range(<NRf> | MIN | MAX | DEF)

Example: SENS:PER:CURR:RANG MAX

Sets the period to the maximum range.

---

[SENSe:]PERiod:CURRent:RANGe?

Returns the period measurement range.

---

[SENSe:]PERiod:CURRent:RANGe:AUTO

Sets the Period Auto-range settings on, off or once.

Parameter: 0 | 1 | ON | OFF | ONCE

Example: SENS:PER:CURR:RANG:AUTO OFF

Turns the Auto-range setting off for period measurement.

---

[SENSe:]PERiod:CURRent:RANGe:AUTO?

Returns the Period Auto-range setting.

Return parameter: 0 | 1, 0=OFF, 1=ON

---

---

[SENSe:]PERiod:INPutjack

Assigns an input port for the period function.

Parameter: <NR1> (0 | 1 | 2), 0=Voltage, 1=3A, 2=10A

Example: SENS:PER:INP 1

Sets the input jack to the current 3A input port.

---

[SENSe:]PERiod:INPutjack?

Returns the assigned input port used for the period function.

Return parameter: VOLT | 3A | 10A

---

[SENSe:]PERiod:NULL[:STATe]

Sets the relative function on/off for Period measurement.

Parameter: 0 | 1 | ON | OFF

Example: SENS:PER:NULL:STAT ON

Turns the relative function on for Period measurement.

---

[SENSe:]PERiod:NULL[:STATe]?

Returns the relative function state of Period measurement.

Return parameter: 0 | 1, 0=OFF, 1=ON

---

[SENSe:]PERiod:NULL:VALue

Sets the relative value for Period measurement.

Parameter: <NRf> (-1.2~1.2 s) | MIN | MAX | DEF

Example: SENS:FREQ:NULL:VAL 1

Sets the relative value to 1s for Period measurement.

---

[SENSe:]PERiod:NULL:VALue?

Returns the current relative value of Period measurement.

---

[SENSe:]PERiod:NULL:VALue:AUTO

Sets the relative value auto on/off for Period measurement.

Parameter: 0 | 1 | ON | OFF

Example: SENS:PER:NULL:STAT ON

SENS:PER:NULL:VAL:AUTO ON

The unit automatically sets the 1st count of measurement as null value.

---

[SENSe:]PERiod:NULL:VALue:AUTO?

Returns the null value auto state of Period measurement.

---

[SENSe:]PERiod:TIMEout:AUTO

Assigns timeout time at the period measurement.

Parameter: 0 | 1 | ON | OFF

Example: SENS:PER:TIM:AUTO ON

Sets the timeout time in according with ac filter bandwidth (gete time).

---

---

[SENSe:]PERiod:TIMEout:AUTO?

Returns the assigned timeout time used for the period function.

Return parameter: 0 | 1, 0:timeout time = 1 second, 1:timeout time is different in according with ac filter bandwidth (gate time).

---

[SENSe:]PERiod:TRIGger:DELay

Sets the trigger delay time that minimum step is microseconds of Period measurement.

Parameter: <NRf> (0 ~ 3600 s) | MIN | MAX | DEF

Example: SENS:PER:TRIG:DEL 0.05

Sets the trigger delay time to 50ms of Period measurement.

---

[SENSe:]PERiod:TRIGger:DELay?

Returns the trigger delay time in seconds of Period measurement.

Return parameter: <NRf>

---

[SENSe:]PERiod:VOLTage:RANGe

Sets the period measurement range.

Parameter: Range(<NRf> | MIN | MAX | DEF)

Example: SENS:PER:VOLT:RANG DEF

Sets the period to the default range.

---

[SENSe:]PERiod:VOLTage:RANGe?

Returns the period measurement range.

---

[SENSe:]PERiod:VOLTage:RANGe:AUTO

Sets the Period Auto-range settings on, off or once.

Parameter: 0 | 1 | ON | OFF | ONCE

Example: SENS:PER:VOLT:RANG:AUTO OFF

Turns the Auto-range setting off for period measurements.

---

[SENSe:]PERiod:VOLTage:RANGe:AUTO?

Returns the Period Auto-range setting.

Return parameter: 0 | 1, 0=OFF, 1=ON

---

## SENSe TEMPerature Commands

---

[SENSe:]TEMPerature:NPLCycles

Sets the integration time for Temperature measurement in PLCs (power line cycles). Where one PLC is equal to 16.6 milliseconds. For any <NRf> parameter, the DMM will automatically set the PLC to the closest acceptable PLC value (1 | 3 | 12).

Parameter: NPLCycles(<NRf> | MIN | MAX | DEF)

---

---

Example: SENS:TEMP:NPLC DEF

Sets the integration time to the 12 PLCs for Temperature measurement.

---

[SENSe:]TEMPerature:NPLCycles?

Returns the integration time for Temperature measurement in PLCs (power line cycles). Where one PLC is equal to 16.6 milliseconds.

Return parameter: 1 | 3 | 12

---

[SENSe:]TEMPerature:NULL[:STATe]

Sets the relative function on/off for Temperature measurement.

Parameter: 0 | 1 | ON | OFF

Example: SENS:TEMP:NULL:STAT ON

Turns the relative function on for Period measurement.

---

[SENSe:]TEMPerature:NULL[:STATe]?

Returns the relative function state of Temperature measurement.

Return parameter: 0 | 1, 0=OFF, 1=ON

---

[SENSe:]TEMPerature:NULL:VALue

Sets the relative value for Temperature measurement.

Parameter: <NRf> (-1.0e15~1.0e15) | MIN | MAX | DEF

Example: SENS:FREQ:NULL:VAL 5

Sets the relative value to 5°C for Temperature measurement.

---

[SENSe:]TEMPerature:NULL:VALue?

Returns the current relative value of Temperature measurement.

---

[SENSe:]TEMPerature:NULL:VALue:AUTO

Sets the relative value auto on/off for Temperature measurement.

Parameter: 0 | 1 | ON | OFF

Example: SENS:TEMP:NULL:STAT ON

SENS:TEMP:NULL:VAL:AUTO ON

The unit automatically sets the 1st count of measurement as null value.

---

[SENSe:]TEMPerature:NULL:VALue:AUTO?

Returns the null value auto state of Temperature measurement.

---

[SENSe:]TEMPerature:RESolution

Sets the Temperature measurement resolution. The resolution depends on the rate and range settings.

Parameter: Resolution(<NRf> | MIN | MAX | DEF)

Example: SENS:TEMP:RES MAX

Sets the Temperature resolution to the maximum.

---

[SENSe:]TEMPerature:RESolution?	Returns the temperature measurement resolution.
[SENSe:]TEMPerature:TRANsducer:TYPE	Sets the temperature probe type. Parameter: [None]   TC   RTD   FRTD   THER   FTH Example: SENS:TEMP:TRAN:TYPE RTD Sets the temperature probe type to RTD.
[SENSe:]TEMPerature:TRANsducer:TYPE?	Returns the temperature probe type. Return parameter: TC, RTD, FRTD, THER, FTH
[SENSe:]TEMPerature:TRIGger:DELAy	Sets the trigger delay time that minimum step is microseconds of Temperature measurement. Parameter: <NRf> (0 ~ 3600 s)   MIN   MAX   DEF Example: SENS:TEMP:TRIG:DEL 0.001 Sets the trigger delay time to 1ms of Temperature measurement.
[SENSe:]TEMPerature:TRIGger:DELAy?	Returns the trigger delay time in seconds of Temperature measurement. Return parameter: <NRf>
[SENSe:]TEMPerature:ZERO:AUTO	Sets the auto zero mode to on, off or once of Temperature measurement. Parameter: 0   1   ON   OFF   ONCE Example: SENS:TEMP:ZERO:AUTO OFF Sets the auto zero to off.
[SENSe:]TEMPerature:ZERO:AUTO?	Returns the auto zero mode of Temperature measurement. Return Parameter: 0   1, 1=ON, 0=OFF
[SENSe:]TEMPerature:RJUNction:SIMulated	Sets temperature simulation value of thermocouple measurement. Parameter: <NRf> (-20.00 ~ 80.00)   MIN   MAX   DEF Example: SENS:TEMP:RJUN:SIM 25.00 Sets the thermocouple junction temperature to 25°C.
[SENSe:]TEMPerature:RJUNction:SIMulated?	Returns temperature simulation value of thermocouple measurement. Return parameter: <NRf> (-2.00000000E+01~+8.00000000E+01), where unit = °C

[SENSe:]TEMPerature:RJUNction:SIMulated:AUTO

Sets junction reference temperature of thermocouple measurement used by simulation temperature or internal temperature of front panel.

Parameter: 0 | 1 | ON | OFF

Example: SENS:TEMP:RJUN:SIM:AUTO ON

Sets the thermocouple junction temperature used by internal temperature.

---

[SENSe:]TEMPerature:RJUNction:SIMulated:AUTO?

Returns thermocouple measurement which junction reference temperature is selected.

Return Parameter: 0 | 1, 1= internal temperature, 0= simulation temperature

---

[SENSe:]TEMPerature:RJUNction:SIMulated:AUTO:OFFSet

Sets junction reference temperature adjust value of thermocouple measurement which internal temperature is selected.

Parameter: <NRf> (-20.00 ~ 20.00) | MIN | MAX | DEF

Example: SENS:TEMP:RJUN:SIM:AUTO:OFFS 5

Sets the junction reference temperature adjust value to 5 °C

---

[SENSe:]TEMPerature:RJUNction:SIMulated:AUTO:OFFSet?

Returns junction reference temperature adjust value of thermocouple measurement.

Return Parameter: <NRf> (-2.00000000E+01~+2.00000000E+01), where unit = °C

---

[SENSe:]TEMPerature:RJUNction:SIMulated:AUTO:TEMPerature?

Returns internal temperature of thermocouple measurement.

Return Parameter: <NRf> (-5.50000000E+01~+1.25000000E+02), where unit = °C

---

[SENSe:]TEMPerature:TCOuple:TYPE

Sets the thermocouple type.

Parameter: Type(J | K | N | R | S | T | B | E)

Example: SENS:TEMP:TCO:TYPE J

Sets the thermocouple to type J.

---

[SENSe:]TEMPerature:TCOuple:TYPE?

Returns the thermocouple type.

Return parameter: J | K | N | R | S | T | B | E

---

[SENSe:]TEMPerature:RTD:ALPHA

Sets the 2-wire RTD Alpha coefficient.

Parameter: <NRf> (0.0~9.999999) | MIN | MAX | DEF

Example: SENS:TEMP:RTD:ALPH 0.00385

---



[SENSe:]TEMPerature:RTD:ALPHA?	Returns the 2-wire RTD Alpha coefficient.
[SENSe:]TEMPerature:RTD:BETA	Sets the 2-wire RTD Beta coefficient. Parameter: <Nrf> (0.0~9.999999)   MIN   MAX   DEF Example: SENS:TEMP:RTD:BETA 0.00495
[SENSe:]TEMPerature:RTD:BETA?	Returns the 2-wire RTD Beta coefficient.
[SENSe:]TEMPerature:RTD:DELTA	Sets the 2-wire RTD Delta coefficient. Parameter: <Nrf> (0.0~9.999999)   MIN   MAX   DEF Example: SENS:TEMP:RTD:DELT 0.000568
[SENSe:]TEMPerature:RTD:DELTA?	Returns the 2-wire RTD Delta coefficient.
[SENSe:]TEMPerature:RTD:RESistance[:REFERENCE]	Sets the reference resistance (R0) of 2-wire RTD measurement. Parameter: <Nrf> (80.0~120.0)   MIN   MAX   DEF Example: SENS:TEMP:RTD:RES:REF 100
[SENSe:]TEMPerature:RTD:RESistance[:REFERENCE]?	Returns the 2-wire RTD reference resistance (R0).
[SENSe:]TEMPerature:RTD:TYPE	Sets the 2-wire RTD sensor type. Return parameter: Type(PT100   D100   F100   PT385   PT3916   USER) Example: SENS:TEMP:RTD:TYPE PT100 Sets the 2-wire RTD sensor to PT100
[SENSe:]TEMPerature:RTD:TYPE?	Returns the 2-wire RTD sensor type. Return parameter: PT100   D100   F100   PT385   PT3916   USER
[SENSe:]TEMPerature:FRTD:ALPHA	Sets the 4-wire RTD Alpha coefficient. Parameter: <Nrf> (0.0~9.999999)   MIN   MAX   DEF Example: SENS:TEMP:FRTD:ALPH 0.00385
[SENSe:]TEMPerature:FRTD:ALPHA?	Returns the 4-wire RTD Alpha coefficient.
[SENSe:]TEMPerature:FRTD:BETA	Sets the 4-wire RTD Beta coefficient. Parameter: <Nrf> (0.0~9.999999)   MIN   MAX   DEF Example: SENS:TEMP:FRTD:BETA 0.00495
[SENSe:]TEMPerature:FRTD:BETA?	Returns the 4-wire RTD Beta coefficient.

[SENSe:]TEMPerature:FRTD:DELTA

Sets the 4-wire RTD Delta coefficient.

Parameter: <NRf> (0.0~9.999999) | MIN | MAX | DEF

Example: SENS:TEMP:FRTD:DELT 0.000568

---

[SENSe:]TEMPerature:FRTD:DELTA?

Returns the 4-wire RTD Delta coefficient.

---

[SENSe:]TEMPerature:FRTD:RESistance[:REFerence]

Sets the reference resistance (R0) of 4-wire RTD measurement

Parameter: <NRf> (80.0 ~ 120.0) | MIN | MAX | DEF

Example: SENS:TEMP:FRTD:RES:REF 100

---

[SENSe:]TEMPerature:FRTD:RESistance[:REFerence]?

Returns the 4-wire RTD reference resistance (R0).

---

[SENSe:]TEMPerature:FRTD:TYPE

Sets the 4-wire RTD sensor type.

Parameter: Type(PT100 | D100 | F100 | PT385 | PT3916 | USER)

Example: SENS:TEMP:FRTD:TYPE PT100

Sets the 4-wire RTD sensor to PT100

---

[SENSe:]TEMPerature:FRTD:TYPE?

Returns the 4-wire RTD sensor type.

Return parameter: PT100 | D100 | F100 | PT385 | PT3916 |

USER

---

[SENSe:]TEMPerature:THERmistor:APARAmeter

Sets the 2-wire Thermistor A coefficient.

Parameter: <NRf> (0.0~9.999999) | MIN | MAX | DEF

Example: SENS:TEMP:THER:APAR 0.002154.

---

[SENSe:]TEMPerature:THERmistor:APARAmeter?

Returns the 2-wire Thermistor A coefficient.

---

[SENSe:]TEMPerature:THERmistor:BPARAmeter

Sets the 2-wire Thermistor B coefficient.

Parameter: <NRf> (0.0~9.999999) | MIN | MAX | DEF

Example: SENS:TEMP:THER:BPAPAR 0.003425

---

[SENSe:]TEMPerature:THERmistor:BPARAmeter?

Returns the 2-wire Thermistor B coefficient.

---

[SENSe:]TEMPerature:THERmistor:CPARAmeter

Sets the 2-wire Thermistor C coefficient.

Parameter: <NRf> (0.0~9.999999) | MIN | MAX | DEF

Example: SENS:TEMP:THER:CPAPAR 0.006993

---

[SENSe:]TEMPerature:THERmistor:CPARAmeter?

Returns the 2-wire Thermistor C coefficient.

---

- 
- [SENSe:]TEMPerature:THERmistor:TYPE  
 Sets the 2-wire Thermistor sensor type.  
 Parameter: Type(2.2k $\Omega$  | 5k $\Omega$  | 10k $\Omega$  | USER)  
 Example: SENS:TEMP:THER:TYPE 2200  
 Sets the 2-wire Thermistor sensor type to 2.2k $\Omega$ .
- 
- [SENSe:]TEMPerature:THERmistor:TYPE?  
 Returns the 2-wire Thermistor sensor type.  
 Return parameter: +2200 | +5000 | +10000 | USER.
- 
- [SENSe:]TEMPerature:FTHermistor:APARAmeter  
 Sets the 4-wire Thermistor A coefficient.  
 Parameter: <NRf> (0.0~9.999999) | MIN | MAX | DEF  
 Example: SENS:TEMP:FTH:APAR 0.002154
- 
- [SENSe:]TEMPerature:FTHermistor:APARAmeter?  
 Returns the 4-wire Thermistor A coefficient.
- 
- [SENSe:]TEMPerature:FTHermistor:BPARAmeter  
 Sets the 4-wire Thermistor B coefficient.  
 Parameter: <NRf> (0.0~9.999999) | MIN | MAX | DEF  
 Example: SENS:TEMP:FTH:BPAR 0.003425
- 
- [SENSe:]TEMPerature:FTHermistor:BPARAmeter?  
 Returns the 4-wire Thermistor B coefficient.
- 
- [SENSe:]TEMPerature:FTHermistor:CPARAmeter  
 Sets the 4-wire Thermistor C coefficient.  
 Parameter: <NRf> (0.0~9.999999) | MIN | MAX | DEF  
 Example: SENS:TEMP:FTH:CPAR 0.006993
- 
- [SENSe:]TEMPerature:FTHermistor:CPARAmeter?  
 Returns the 4-wire Thermistor C coefficient.
- 
- [SENSe:]TEMPerature:FTHermistor:TYPE  
 Sets the 4-wire Thermistor sensor type.  
 Parameter: Type(2.2k $\Omega$  | 5k $\Omega$  | 10k $\Omega$  | USER)  
 Example: SENS:TEMP:FTH:TYPE 10000  
 Sets the 4-wire Thermistor sensor type to 10k $\Omega$ .
- 
- [SENSe:]TEMPerature:FTHermistor:TYPE?  
 Returns the 4-wire Thermistor sensor type.  
 Return parameter: +2200 | +5000 | +10000 | USER.
-

## TRIGger Commands

---

### SAMPlE:COUNT

Sets the number of samples.

Parameter: <NRf>(1.0 ~ 1000000.0) | MIN | MAX | DEF

Example: TRIG:COUN 10

SAMP:COUN 10

INIT

FETC?

Will returns 100 measurment results.

Sets the number of samples to 10.

- The total measurement counts is trigger count multiplication sample count.

---

### SAMPlE:COUNT?

Returns the number of samples.

Return parameter: <NRf>

---

### TRIGger:COUNT

Sets the number of trigger counts.

Parameter: <NRf>(1.0 ~ 1000000.0) | MIN | MAX | DEF

Example: TRIG:COUN 10

SAMP:COUN 10

READ?

Will returns 100 measurment results.

Sets the number of trigger counts to 10.

- The total measurement counts is trigger count multiplication sample count.

---

### TRIGger:COUNT?

Returns the number of trigger counts.

Return parameter: <NRf>

---

### TRIGger:DELaY

Sets the trigger delay time that minimum step is microseconds in all of the function.

Parameter: <NRf> (0 ~ 3600 s) | MIN | MAX | DEF

Example: TRIG:DEL MAX

Sets the trigger delay time to the maximum.

---

### TRIGger:DELaY?

Returns the trigger delay time in seconds of current function.

Return parameter: <NRf>

---

---

TRIGger:DELAy:AUTO

Sets the trigger delay time auto mode on/off in all of the function.

Parameter: 0 | 1 | ON | OFF

Example: TRIG:DEL:AUTO OFF

Turns trigger delay time auto mode off.

---

TRIGger:DELAy:AUTO?

Returns the trigger delay time auto mode state.

Return parameter: 0 | 1, 1=ON, 0=OFF.

---

TRIGger:SLOPe

Selects whether the instrument uses the rising edge (POS) or the falling edge (NEG) of the trigger signal on the rear-panel Digital I/O connector when external trigger is selected;

Parameter: POSitive | NEGative

Example: TRIG:SLOP POS

Sets the trigger signal in rising edge (POS).

---

TRIGger:SLOPe?

Returns the method of external trigger.

Return parameter: POS | NEG

---

TRIGger:SOURce

Selects the trigger source.

Parameter: IMMEDIATE | EXTERNAL | BUS

Example: TRIG:SOUR EXT

Sets the trigger source as external trigger.

IMMEDIATE:

The trigger signal is always present. When you place the instrument in the "wait-for-trigger" state, the trigger is issued immediately.

Ex:SAMP:COUN 5

TRIG:SOUR IMM

READ?

Returns : 5 measurement values.

EXTERNAL:

The instrument accepts hardware triggers applied to the rear-panel Ext Trig input and takes the specified number of measurements (SAMP:COUN), each time a TTL pulse specified by

TRIG:SLOP is received. If the instrument receives an external trigger before it is ready, it buffers one trigger.

Ex:SAMP:COUN 5

---

---

TRIG:SOUR EXT  
TRIG :SLOP NEG  
INIT  
<wait external trigger in signal>  
FETC ?  
Returns : 5 measurement values.

BUS:  
The instrument is triggered by \*TRG over the remote interface once the DMM is in the "wait-for-trigger" state.  
Ex:SAMP:COUN 5  
TRIG:SOUR EXT  
TRIG :SLOP NEG  
INIT  
\*TRG  
FETC ?  
Returns : 5 measurement values.

- After selecting the trigger source, you must place the instrument in the "wait-for-trigger" state by sending INITiate or READ?. A trigger is not accepted from the selected trigger source until the instrument is in the "wait-for-trigger" state.

---

TRIGger:SOURce?  
Returns current trigger source.  
Return parameter: IMM | EXT | BUS

---

OUTPut:TRIGger:SLOPe  
Sets the output signal method after each measurement.  
Parameter: POSitive | NEGative  
Example: OUTP:TRIG:SLOP POS  
Sets the output signal as positive pulse after measurement.

---

OUTPut:TRIGger:SLOPe?  
Returns the output signal method after measurement.  
Return parameter: POS | NEG

---

## SYSTEM Related Commands

---

### SYSTem:BEEPer[:IMMEDIATE]

Makes buzzer beep once.

Parameter: <None>

Example: SYST:BEEP:IMM

- This function is Not affected by the state of SYST:BEEP:STAT.

---

### SYSTem:BEEPer:ERRor

Sets the beeper to sound on an SCPI error.

Parameter: 0 | 1 | ON | OFF

Example: SYST:BEEP:ERR ON

Allows the beeper to sound when an SCPI error occurs.

---

### SYSTem:BEEPer:ERRor?

Returns the beeper error mode.

Return parameter: 0 | 1, 0=OFF, 1=ON

---

### SYSTem:BEEPer:STATe

Turns the buzzer on/off.

Parameter: 0 | 1 | ON | OFF

Example: SYST:BEEP:STAT OFF

Turns the buzzer off.

- The key sound of front panel is Not affected by the state.

- The command of SYSTem:BEEPer is Not affected by the state.

---

### SYSTem:BEEPer:STATe?

Returns the buzzer state.

Return parameter: 0 | 1, 1=ON, 0=OFF.

---

### SYSTem:BEEPer:COMPare:VOLume

Sets the beeper volume of Compare function.

Parameter: <NR1> (0 ~ 2)

0(small), 1(Medium) , 2(Large)

Example: SYST:BEEP:COMP:VOL 2

Sets the beeper volume to large of Compare function.

---

### SYSTem:BEEPer:COMPare:VOLume?

Returns the beeper volume of Compare function.

Return parameter: SMALL | MEDIUM | LARGE

---

### SYSTem:BEEPer:CONTInuity:VOLume

Sets the beeper volume of Continuity function.

Parameter: <NR1> (0 ~ 3)

Example: SYST:BEEP:CONT:VOL 1

Sets the beeper volume to small of Continuity function.

---

---

SYSTEM:BEEPer:CONTInuity:VOLUme?

Returns the beeper volume of Continuity function.

Return parameter: OFF | SMALL | MEDIUM | LARGE

---

SYSTEM:BEEPer:HOLD:VOLUme

Sets the beeper volume of Hold function.

Parameter: <NR1> (0 ~ 3)

Example: SYST:BEEP:HOLD:VOL 2

Sets the beeper volume to medium of Hold function.

---

SYSTEM:BEEPer:HOLD:VOLUme?

Returns the beeper volume of Hold function.

Return parameter: OFF | SMALL | MEDIUM | LARGE

---

SYSTEM:CLICk:STATe

Turns the key sound of front panel on/off.

Parameter: 0 | 1 | ON | OFF

Example: SYST:CLIC:STAT OFF

Turns key sound off.

---

SYSTEM:CLICk:STATe?

Returns the key sound of front panel state.

Return Parameter: 0 | 1, 1=ON, 0=OFF.

---

SYSTEM:DATE

Sets the date for the instrument's real-time clock.

Parameter: <NR1> (year, month, day)

Example: SYST:DATE 2018,03,19

Sets the date to 2018/3/19.

year: 2000~2099

month: 1~12

day: 1~31

---

SYSTEM:DATE?

Returns system date.

Return parameter: <Date>, Ex: 2018,3,19

---

SYSTEM:DISPlay

Turns the TFT LCD display on/off.

Parameter: 0 | 1 | ON | OFF

Example: SYST:DISP ON

Turns the TFT LCD display on.

---

SYSTEM:DISPlay?

Returns the status of the TFT LCD display

Return parameter: 0 | 1, 0=OFF, 1=ON

---

SYSTEM:ERRor[:NEXT]?

Returns the current system error, if any.

---



---

**SYSTem:IDNStr**

Sets a user-defined identification string for the \*IDN? query when the SYSTem:SCPi:MODE command is set to "Compatible".

Parameter: "<manufacturer>", "<model number>", max length 24 characters

Example: SYST:IDNS "ABCDE", "12345"

Sets the user-defined manufacturer as ABCDE and the model number as 12345.

---

**SYSTem:IDNStr?**

Returns the manufacturer and model number set with the SYSTem:IDNStr command.

Return parameter: manufacturer, model number

Example: SYST:IDNS?

>ABCDE, 12345

Returns the manufacturer as ABCDE and the model number as 12345.

---

**SYSTem:LABel**

Places a message in a large font on the bottom half of the instrument's front panel display.

Parameter: "< message >", max length 40 characters

Example: SYST:LAB "RSPRO"

- To turn off the message, send the following to change the label to a null string. This also removes the label area from the screen: SYST:LAB ""

- The parameters will not be saved.

---

**SYSTem:LABel?**

Returns the display message.

Return parameter: "< message >"

---

**SYSTem:LFRequency?**

Returns the AC source line frequency.

Parameter: +50 | +60

---

**SYSTem:OUTPut:EOF**

Sets the EOL character (CR+LF, LF+CR, CR, LF).

Parameter: <NR1>(0~ 3) (0=CR+LF, 1=LF+CR, 2=CR, 3=LF)

Example: SYST:OUTP:EOF 0

Sets the EOL character as CR+LF.

- The parameters will not be saved.

---

**SYSTem:OUTPut:EOF?**

Returns the EOL character.

Return parameter: +0 | +1 | +2 | +3 (0=CR+LF, 1=LF+CR, 3=CR, 4=LF)

---

---

**SYSTEM:OUTPut:SEParate**

Sets the command separation character.

Parameter: 0 | 1 (0=EOL, 1=,)

Example: SYST:OUTP:SEP 0

Sets the command separation character as the EOL character.

- The parameters will not be saved.
- 

**SYSTEM:OUTPut:SEParate?**

Returns the command separation character.

Return parameter: 0 | 1 (0=EOL, 1=,)

---

**SYSTEM:PARAmeter:LOAD**

Load the system parameters from 0 of 5 memory locations.

Parameter: <NR1> (0~5) (0=Default settings, 1~5= memory number)

Example: SYST:PAR:LOAD 0

Loads the default system parameters.

---

**SYSTEM:PARAmeter:LOAD?**

Returns the loaded system parameters.

Return parameter: <NR1> (0~5) (0=Default settings, 1~5= memory number, Last = State before power-off)

---

**SYSTEM:PARAmeter:SAVE**

Saves the system parameters into 1 of 5 memory slots.

Parameter: <NR1> (1~5)

Example: SYST:PAR:SAVE 1

Saves the system parameters to memory 1.

---

**SYSTEM:PRESet**

This command is nearly identical to \*RST. The difference is that \*RST resets the instrument for SCPI operation, and SYSTEM:PRESet resets the instrument for front panel operation. As a result, \*RST turns the histogram and statistics off, and SYSTEM:PRESet turns them on.

---

**SYSTEM:SCPi:MODE**

Sets the SCPI mode. The SCPI mode is used to determine whether the \*IDN? query returns the “Normal” or “Compatible” identification string. See the SYSTEM:IDNStr command for details.

Parameter: NOR | GDM | COMP (NOR=Normal, GDM=8261A, COMP= User-define)

Example: SYST:SCP:MODE NOR

Sets the SCPI mode to normal.

- The parameters will not be saved.
-

---

**SYSTem:SCPi:MODE?**

Returns the SCPI mode. The SCPI mode is used to determine whether the \*IDN? query returns the “Normal” or “Compatible” identification string . See the SYSTem:IDNStr command for details.

Return parameter: NORMAL | GDM8261A | COMPATIBLE

---

**SYSTem:SERial?**

Returns the serial number (nine characters/numbers)

---

**SYSTem:TEMPerature?**

Returns the internal temperature of machine.

Return parameter: <NRf>, where unit = °C

---

**SYSTem:TIME**

Sets the time for the instrument's real-time clock.

Parameter: <NR1> (hour, minute, second)

Example: SYST:TIME 16,20,30

Sets the time to 16:20:30

hour: 0~23

minute: 0~60

second: 0~60

---

**SYSTem:TIME?**

Returns system time.

Return parameter: <Time>, Ex: 16:20:40.000

---

**SYSTem:UPTime?**

Returns the amount of time that the instrument has been running since the last power-on.

Return parameter: +0, +1, +25, +53 (day, hour, minute, second)

---

**SYSTem:VERSion?**

Returns SCPI version.

Return parameter: 1994.0.

---

**SYSTem:WMESsage**

Displays a power-on message.

Parameter: “<string>”, max length 40 characters

Example: SYST:WMES “RSPRO”

● Specifying a null string (“”) disables the power-on message.

---

**SYSTem:WMESsage?**

Returns the display string that is showing after power on.

Return parameter: “<string>”

---

## SYSTEM COMMunication Commands

---

SYSTEM:COMMunicate:GPIB:ADDRess

Sets the GPIB address that is only on GPIB communication bus.

Parameter: <NR1> (0 ~ 30) | MIN | MAX | DEF

Example: SYST:COMM:GPIB:ADDR 15

Sets the GPIB address to 15.

---

SYSTEM:COMMunicate:GPIB:ADDRess?

Returns the GPIB address.

Return parameter: <NR1> (0~30)

---

SYSTEM:COMMunicate:LAN:DHCP

Sets the DHCP on/off.

Parameter: 0 | 1 | ON | OFF

Example: SYST:COMM:LAN:DHCP ON

Sets the DHCP on to automaticall get related configuration information.

---

SYSTEM:COMMunicate:LAN:DHCP?

Returns the DHCP state.

Return parameter: 0 | 1, 0=OFF, 1=ON

---

SYSTEM:COMMunicate:LAN:DNS[X]

Sets the DNS address. which X = 1 indicate DNS1, X = 2 indicate DNS2.

Parameter: "<address>"

Example: SYST:COMM:LAN:DNS1 "172.16.1.252"

Sets the DNS1 address to 172.16.1.252.

---

SYSTEM:COMMunicate:LAN:DNS[X]?

Returns the DNS address. which X = 1 indicate DNS1, X = 2 indicate DNS2.

Return parameter: xxx.xxx.xxx.xxx

---

SYSTEM:COMMunicate:LAN:GATeway

Sets the Gateway address.

Parameter: "<address>"

Example: SYST:COMM:LAN:GAT "192.168.31.254"

Sets the Gatway address to 192.168.31.254.

---

SYSTEM:COMMunicate:LAN:GATeway?

Returns the Gateway address.

Return parameter: xxx.xxx.xxx.xxx

---

---

SYSTem:COMMunicate:LAN:HOSTname

Sets the hostname.

Parameter: "<string>", max length = 15 characters

Example: SYST:COMM:LAN:HOST "DMM"

Sets the Hostname to DMM.

---

SYSTem:COMMunicate:LAN:HOSTname?

Returns the hostname.

Return parameter: "<string>"

---

SYSTem:COMMunicate:LAN:IPADdress

Sets the IP address.

Parameter: "<address>"

Example: SYST:COMM:LAN:IPAD "192.168.31.117"

Sets the IP address to 192.168.31.117.

---

SYSTem:COMMunicate:LAN:IPADdress?

Returns the IP address.

Return parameter: xxx.xxx.xxx.xxx

---

SYSTem:COMMunicate:LAN:MAC?

Returns the MAC number.

Return parameter: 12 Hexadecimal characters.

---

SYSTem:COMMunicate:LAN:SMASk

Sets the subnet mask address.

Parameter: "<address>"

Example: SYST:COMM:LAN:SMAS "255.255.255.0"

Sets the subnet mask address to 255.255.255.0.

---

SYSTem:COMMunicate:LAN:SMASk?

Returns the subnet mask address.

Return parameter: xxx.xxx.xxx.xxx

---

SYSTem:COMMunicate:LAN:TELNet:ECHO

Sets the Telnet communication echo state.

Parameter: 0 | 1 | ON | OFF

Example: SYST:COMM:LAN:TELN:ECHO ON

Sets the Telnet communication echo to on.

---

SYSTem:COMMunicate:LAN:TELNet:ECHO?

Returns the Telnet communication echo state.

Return parameter: 0 | 1, 0=OFF, 1=ON

---

SYSTem:COMMunicate:LAN:TELNet:ENABle

Sets the Telnet communication enable/disable.

Parameter: 0 | 1 | ON | OFF

Example: SYST:COMM:LAN:TELN:ENAB ON

Enables the Telnet communication.

---

---

SYSTEM:COMMunicate:LAN:TELNet:ENABLE?

Returns the Telnet communication state.

Return parameter: 0 | 1, 0=OFF, 1=ON

---

SYSTEM:COMMunicate:LAN:TELNet:PORT

Sets the Telnet communication port number.

Parameter: <NR1> (1024~65535) | MIN | MAX | DEF

Example: SYST:COMM:LAN:TELN:PORT "3000"

Sets the Telnet port to 3000.

---

SYSTEM:COMMunicate:LAN:TELNet:PORT?

Returns the Telnet port number.

Return parameter: <NR1>

---

SYSTEM:COMMunicate:LAN:TELNet:PROMpt

Sets the telnet prompt message.

Parameter: "<string>", max length 15 characters

Example: SYST:COMM:LAN:TELN:PROM "RSDM906X>"

Sets the telnet prompt characters to RSDM906X>.

---

SYSTEM:COMMunicate:LAN:TELNet:PROMpt?

Returns the telnet prompt message.

Return parameter: "<string>"

---

SYSTEM:COMMunicate:LAN:TELNet:TIMEout

Sets the timeout time for auto logout from Telnet communication, where unit of time is second.

Parameter: <NR1> (0~60000)

Example: SYST:COMM:LAN:TELN:TIM 0

Since 0 indicates infinite, Telnet communication has no timeout always.

---

SYSTEM:COMMunicate:LAN:TELNet:TIMEout?

Returns the set time for timeout of Telnet communication.

Return parameter: <NR1>

---

SYSTEM:COMMunicate:LAN:TELNet:WMESsage

Sets the telnet welcome message that telnet communication connect success.

Parameter: "<string>", max length 63 characters

Example: SYST:COMM:LAN:TELN:WMES "Welcome to RSDM906X Telnet Server"

Sets the telnet welcome message to Welcome to RSDM906X Telnet Server.

---

SYSTEM:COMMunicate:LAN:TELNet:WMESsage?

Returns the telnet welcome message.

Return parameter: "<string>"

---

---

SYSTem:COMMunicate:LAN:TCP:ENABLE

Sets the TCP communication enable/disable.

Parameter: 0 | 1 | ON | OFF

Example: SYST:COMM:LAN:TCP:ENAB ON

Enables the TCP communication.

---

SYSTem:COMMunicate:LAN:TCP:ENABLE?

Returns the TCP communication state.

Return parameter: 0 | 1, 0=OFF, 1=ON

---

SYSTem:COMMunicate:LAN:TCP:PORT

Sets the TCP communication port number.

Parameter: <NR1> (1024~65535) | MIN | MAX | DEF

Example: SYST:COMM:LAN:TCP:PORT "3001"

Sets the TCP port to 3001.

---

SYSTem:COMMunicate:LAN:TCP:PORT?

Returns the TCP port number.

Return parameter: <NR1>

---

SYSTem:COMMunicate:LAN:TIMEout

Sets the TCP communication timeout time, where unit = second.

Parameter: <NR1> (1~60000)

Example: SYST:COMM:LAN:TIM 10

Makes the TCP communication timeout time to 10s.

---

SYSTem:COMMunicate:LAN:TIMEout?

Returns the TCP communication timeout time.

Return parameter: <NR1>

---

SYSTem:COMMunicate:LAN:WEB:ENABLE

Sets the Web page communication enable/disable.

Parameter: 0 | 1 | ON | OFF

Example: SYST:COMM:LAN:WEB:ENAB ON

Enables the Web page communication.

---

SYSTem:COMMunicate:LAN:WEB:ENABLE?

Returns the Web page communication state.

Return parameter: 0 | 1, 0=OFF, 1=ON

---

## RS-232C Interface Commands

---

### SYSTem:LOCal

Enables local control (front panel control) and disables remote control.

---

### SYSTem:REMOte

Enables remote control and disables local control (front panel control, all key are disable except Shift key(return to local control)).

---

### SYSTem:RWLock

Enables remote control and disables local control (front panel control, all key are disable).

---

## STATus Report Commands

---

### STATus:OPERation:CONDition?

Returns the total number of the Operation Condition register.  
Return parameter: <NR1>, Ex: +4096

- A condition register continuously monitors the state of the instrument. Condition register bits are updated in real time; they are neither latched nor buffered.

This register is read-only; bits are not cleared when read.

---

### STATus:OPERation:ENABle

Sets bits in the Operation Enable register.

Parameter: <NR1> (0~32767)

Example: STAT:OPER:ENAB 10

Sets the bit1 and bit3 in Operation Enable register,  $10 = 2^1 + 2^3$ .

- The selected bits are then reported to the Status Byte. An enable register defines which bits in the event register will be reported to the Status Byte register group. You can write to or read from an enable register.

- A STATus:PRESet clears all bits in the enable register.

- The \*PSC command controls whether the enable register is cleared at power on.
- 

### STATus:OPERation:ENABle?

Returns the total number of the Operation Enable register.

Return parameter: <NR1>, Ex: +256

---



---

**STATus:OPERation[:EVENT]?**

Returns the total number of the Operation Event register.  
Return parameter: <NR1>, Ex: +786

- An event register is a read-only register that latches events from the condition register. While an event bit is set, subsequent events corresponding to that bit are ignored.
  - Once a bit is set, it remains set until cleared by reading the event register or by sending \*CLS (clear status).
- 

**STATus:PRESet**

Clears the Operation Enable register and Questionable Enable register.

Example: STAT:PRES

---

**STATus:QUEStionable:CONDition?**

Returns the contents of the Questionable Condition register.  
Return parameter: <NR1>, Ex: +2

- A condition register continuously monitors the state of the instrument. Condition register bits are updated in real time; they are neither latched nor buffered.
  - This register is read-only; bits are not cleared when read.
- 

**STATus:QUEStionable:ENABle**

Set bits in the Ouesrionable Enable register.

Parameter: <NR1> (0~32767)

Example: STAT:QUES:ENAB 4099

Sets the bit0, bit1 and bit12 in Ouesrionable Enable register,  
 $4099 = 2^0 + 2^1 + 2^{12}$ .

- The selected bits are then reported to the Status Byte. An enable register defines which bits in the event register will be reported to the Status Byte register group. You can write to or read from an enable register.
  - A STATus:PRESet clears all bits in the enable register.
  - The \*PSC command controls whether the enable register is cleared at power on.
- 

**STATus:QUEStionable:ENABle?**

Returns the total number of the Ouesrionable Enable register.  
Return parameter: <NR1>, Ex: +1

---

---

### STATUS:QUESTIONABLE[:EVENT]?

Returns the total number of the Questionable Event register.  
Return parameter: <NR1>, Ex: +2

- An event register is a read-only register that latches events from the condition register. While an event bit is set, subsequent events corresponding to that bit are ignored.
  - Once a bit is set, it remains set until cleared by reading the event register or by sending \*CLS (clear status).
- 

## IEEE 488.2 Common Commands

---

### \*CLS

Clears the Event Status register (Output Queue, Operation Event Status, Questionable Event Status, Standard Event Status Register)

---

### \*ESE?

Returns the ESER (Event Status Enable Register) contents.  
Example: \*ESE?

>130

Returns 130. ESER=10000010

---

### \*ESE

Sets the ESER contents.  
Parameter: <NR1> (0~255)  
Ex: \*ESE 65  
Sets the ESER to 01000001

- The selected bits are then reported to bit 5 of the Status Byte Register. An enable register defines which bits in the event register will be reported to the Status Byte register group. You can write to Or read from an enable register.
- 

### \*ESR?

Returns SESR (Standard Event Status Register) contents.  
Ex: \*ESR?

>198

Returns 198. SESR=11000110

- An event register is a read-only register that latches events from the condition register. While an event bit is set, subsequent events corresponding to that bit are ignored.
  - Once a bit is set, it remains set until cleared by reading the
-

---

event register or by sending \*CLS (clear status).

---

\*IDN?

Returns the manufacturer, model No., serial number and system version number.

Example: \*IDN?

>RSPRO,RSDM9061,000000000,M0.70\_S0.25B

---

\*OPC?

Returns 1 to the output buffer after all pending commands complete. Other commands cannot be executed until this command completes.

Ex: CONF:VOLT:DC

SAMP:COUN 100

INIT

\*OPC?

- The difference between \*OPC and \*OPC? is that\*OPC sets a status bit when the operation completes,and \*OPC? outputs "1" when the operation completes.
- 

\*OPC

Sets operation complete bit (bit0) in SESR (Standard Event Status Register) when all pending operations are completed.

Ex: \*CLS

\*ESE 1

\*SRE 32

CONF:VOLT:DC

SAMP:COUN 10

INIT

\*OPC

- The difference between \*OPC and \*OPC? is that\*OPC sets a status bit when the operation completes,and \*OPC? outputs "1" when the operation completes.
- 

\*OPT?

Returns a string identifying any installed options.

---

---

**\*PSC**

Clears Power On status.

Parameter: <Boolean>(0|1) 0= disables, 1= enables

- Enables (1) or disables (0) the clearing of certain enable registers at power on:

Questionable Data Register (STATus:OPERation:ENABLE)

Standard Operation Register (STATus:QUEStionable:ENABLE)

Status Byte Condition Register (\*SRE)

Standard Event Enable Register (\*ESE)

- The \*PSC command does not affect the clearing of the condition or event registers, just the enable registers.
- 

**\*PSC?**

Returns power on clear status.

Return parameter: <Boolean>(0|1) 0= disables, 1= enables

---

**\*RCL**

Load the system parameters from 0 of 5 memory locations.

Parameter: <NR1> (0~5) (0=Default settings, 1~5= memory number)

Example: \*RCL 1

Loads the memory 1 system parameters.

---

**\*RST**

Recalls default panel setup.

- Resets instrument to factory default state. This is similar to SYSTem:PRESet. The difference is that \*RST resets the instrument for SCPI operation, and SYSTem:PRESet resets the instrument for front panel operation. As a result, \*RST turns the histogram and statistics off, and SYSTem:PRESet turns them on.
- 

**\*SAV**

Save the system parameters to 1 of 5 memory locations.

Parameter: <NR1> (1~5) (1~5= memory number)

Example: \*SAV 2

Saves the system parameters to memory 2.

---

**\*SRE?**

Returns the SRER (Service Request Enable Register) contents.

---

---

**\*SRE**

Sets SRER contents.

Parameter: <NR1>(0~255)

Example: \*SRE 7

Sets the SRER to 00000111.

- An enable register defines which bits in the event register will be reported to the Status Byte register group. You can write to or read from an enable register.

---

**\*STB?**

Returns the SBR (Status Byte Register) contents.

Example:\*STB?

>81

Returns the contents of the SBR as 01010001.

- A condition register continuously monitors the state of the instrument. Condition register bits are updated in real time; they are neither latched nor buffered.
- This register is read-only; bits are not cleared when read.

---

**\*TRG**

Manually triggers the RSDM-906X if TRIG:SOUR is selected to BUS.

Ex:SAMP:COUN 10

TRIG:SOUR BUS

INIT

\*TRG

FETC?

---

**\*WAI**

Configures the instrument's output buffer to wait for all pending operations to complete before executing any additional commands over the interface.

---

# Status system

The diagram below is a description of the status system

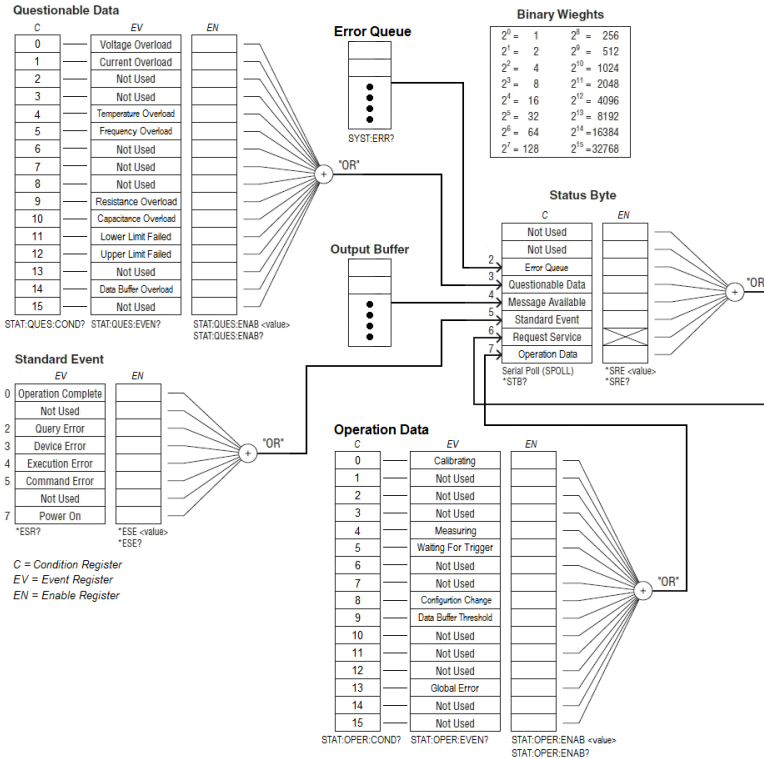

The following table lists the bit definitions for the Questionable Data Register:



Note: The overload bits are set once per INITiate command. If you clear an overload bit, it is not set again until a new INITiate is sent.

Bit	Name	Decimal	Definition
0	Voltage Overload	1	Only reported as event. In Condition Register this bit always returns 0. Read the Event Register.

1	Current Overload	2	Only reported as event. In Conditon Register this bit always returns 0. Read the Event Register.
2	Not Used	4	(Reserved for future use)
3	Not Used	8	(Reserved for future use)
4	Temperature Overload	16	Only reported as event. In Conditon Register this bit always returns 0. Read the Event Register.
5	Frequency Overload	32	Only reported as event. In Conditon Register this bit always returns 0. Read the Event Register.
6	Not Used	64	(Reserved for future use)
7	Not Used	128	(Reserved for future use)
8	Not Used	256	(Reserved for future use)
9	Resistance Overload	512	Only reported as event. In Conditon Register this bit always returns 0. Read the Event Register.
10	Capacitance Overload	1024	Only reported as event. In Conditon Register this bit always returns 0. Read the Event Register.
11	Lower Limit Failed	2048	The most recent measurement failed the lower limit test.
12	Upper Limit Failed	4096	The most recent measurement failed the upper limit test.
13	Not Used	8192	(Reserved for future use)
14	Data Buffer Overload	16384	Data buffer is full. One or more (oldest) measurements have been lost.
15	Not Used	32768	(Reserved for future use)

The following table lists the bit definitions for the Operation Data Register:

Bit	Name	Decimal	Definition
0	Calibrating	1	Instrument is performing a calibration.
1	Not Used	2	(Reserved for future use)
2	Not Used	4	(Reserved for future use)
3	Not Used	8	(Reserved for future use)
4	Measuring	16	Instrument is initiated, and is making or about to make a measurement.
5	Waitig For Trigger	32	Instrument is waiting for a trigger.
6	Not Used	64	(Reserved for future use)
7	Not Used	128	(Reserved for future use)
8	Configurition Change	256	Instrument configuration has been changed since the last INIT, READ? or MEASure?, either from the front panel or from SCPI.
9	Data Output Threshold	512	Programmed number of measurements (DATA:POINts:EVENT:THReshold) have been stored in measurement memory.
10	Not Used	1024	(Reserved for future use)
11	Not Used	2048	(Reserved for future use)
12	Not Used	4096	(Reserved for future use)
13	Global Error	8192	Set if any remote interface has an error in its error queue; cleared otherwise.
14	Not Used	16384	(Reserved for future use)
15	Not Used	32768	(Reserved for future use)



The following table describes the Standard Event Register

Bit	Name	Decimal	Definition
0	Operation Complete	1	All commands prior to and including *OPC have been executed.
1	Not Used	2	(Reserved for future use)
2	Query Error	4	The instrument tried to read the output buffer but it was empty. Or, a new command line was received before a previous query has been read. Or, both the input and output buffers are full.
3	Device Error	8	A device error, including a self-test error or calibration error, occurred (an error in the -300 range or any positive error has been generated).
4	Execution Error	16	An execution error occurred (an error in the -200 range has been generated).
5	Command Error	32	A command syntax error occurred (an error in the -100 range has been generated).
6	Not Used	64	(Reserved for future use)
7	Power On	128	Power has been cycled since the last time the event register was read or cleared.

The following table describes the Status Byte Register.

Bit	Name	Decimal	Definition
0	Not Used	1	(Reserved for future use)
1	Not Used	2	(Reserved for future use)
2	Error Queue	4	One or more errors have been stored in the Error Queue. Use SYST:ERR? to read and delete errors.
3	Questionable Data	8	One or more bits are set in the Questionable Data Register (bits must be enabled, see STAT:QUES:ENAB).
4	Message Available	16	Data is available in the instrument's output buffer.
5	Standard Event	32	One or more bits are set in the Standard Event Register (bits must be enabled, see *ESE).
6	Request Service	64	One or more bits are set in the Status Byte Register and may generate a Request for Service(RQS). Bits must be enabled using *SRE.
7	Operation Data	128	One or more bits are set in the Standard Operation Register (bits must be enabled, see STAT:OPER:ENAB).

# APPENDIX

---

Fuse Replacement .....	376
Replace AC Source Fuse .....	376
Replace 3A Input Current Fuse.....	377
Replace Internal 3A/10A Input Current Fuse .....	378
Battery Replacement .....	380
Factory Default Parameters .....	382
Specifications.....	387
General.....	387
RSDM-9061 .....	389
DC Characteristics <sup>[1]</sup> .....	389
Measuring Characteristics .....	390
AC Characteristics <sup>[1]</sup> .....	392
Measuring Characteristics .....	394
Operating Characteristics .....	394
Frequency and Period Characteristics .....	395
Measuring Characteristics .....	395
Operating Characteristics .....	396
Temperature Characteristics <sup>[1]</sup> (Exclusive of probe errors) .....	396
Capacitance.....	398
RSDM-9060 .....	399
DC Characteristics <sup>[1]</sup> .....	399
Measuring Characteristics .....	400
AC Characteristics <sup>[1]</sup> .....	402
Measuring Characteristics .....	403
Operating Characteristics .....	404
Frequency and Period Characteristics .....	405
Measuring Characteristics .....	405
Operating Characteristics .....	405
Temperature Characteristics <sup>[1]</sup> (Exclusive of probe errors) .....	406
Capacitance.....	407
Dimensions.....	409
Declaration of Conformity .....	410

# Fuse Replacement

## Replace AC Source Fuse

### Steps

1. Take off the power cord and place dual flat-blade drivers into the grooves of fuse socket sideways followed by pinch together to pull out the fuse socket.

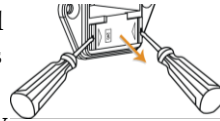

2. The fuse socket appears. The "240" symbol within the hole on fuse socket indicates the line voltage is positioned as 240V.

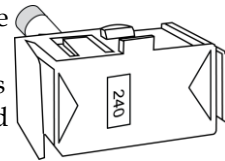

3. Pull the fuse holder out of the fuse socket gently as the right figure illustrates.

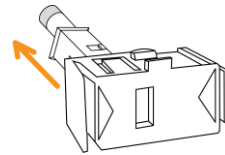

4. Further pull the fuse out of the fuse holder and replace it with a new fuse.

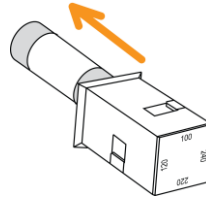

5. Restore the fuse holder with new fuse back to the fuse socket. Ensure the correct line voltage shows within the hole of the fuse socket per requirement.

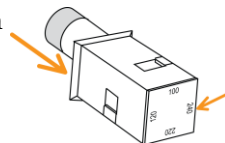

Rating	Type of fuse (time-lag)	Input line voltage
	T0.25A,250V,5x20mm	100/120VAC
	T0.125A,250V,5x20mm	220/240VAC

## Replace 3A Input Current Fuse

**Preparation** To make sure if 3A input current needs to be replaced, press the button to set RSDM-9060/9061 in Continuity mode and short circuit the HI input terminal with the 3A input current terminal.

If the test result shows OPEN, either one of the fuses requires replacement. The one is accessible from the rear panel, and the other one is within the internal part.

If either one of the fuses of 3A input current is damaged, please first check the one (3.15 A, 500 V) in the lower-left corner of rear panel.

- Step**
1. Turn the RSDM-9060/9061 off
  2. Press and hold the fuse holder in the rear panel followed by rotating it counterclockwise with a flat-blade screwdriver.

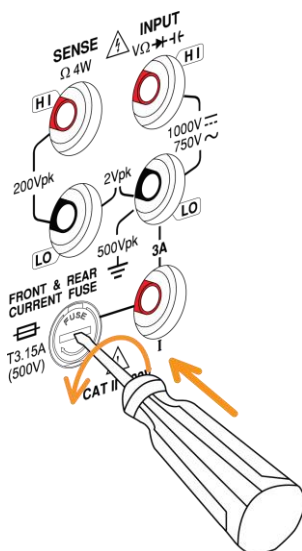

- The fuse holder comes out. Replace the fuse inserted at the end of the holder followed by rotating the fuser holder clockwise to fasten it firmly.

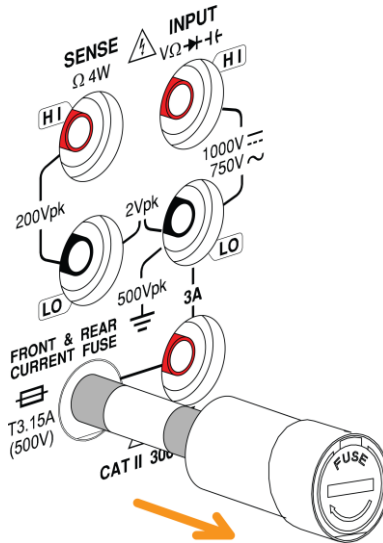

Rating T3.15A, 500V , 5\*20mm

### Replace Internal 3A/10A Input Current Fuse

Preparation	Replace internal 3A input fuse	If there is still a damaged fuse in 3A input current, follow the instructions in the following section to replace fuse of internal 3A input current.
	Replace internal 10A input fuse (RSDM-9061 only)	To make sure if 10A input current needs to be replaced, press the  button to set RSDM-9060/9061 in Continuity mode and short circuit the HI input terminal with the 10A input current terminal. If the test result shows OPEN, follow the following section to replace fuse of internal 10A input current.

## Internal Fuse Spec

	Location	Current	Voltage	Type	Dimension
Internal 3A input current fuse	F502	6A	1000V	Fast-blow type	10 x 38mm
Internal 10A input current fuse	F601	12A	1000V	Fast-blow type	10 x 38mm

### Steps for Internal Fuse Replacement

1. Power off properly and disconnect all the test leads, cables including power cord.
2. Disassemble the instrument case in light of the disassembling instructions.
3. Make sure the certain fuse to be replaced as the figures below shown.

Internal 3A input current fuse



Internal 10A input current fuse



4. Pull the fuse out from the fuse holder with a flat-blade screwdriver. Be cautious Not to damage the printed circuit board (PCB).
5. Disassemble the fuse.

- 
6. Place the new fuse into the fuse holder. Gently push the fuse downwards to make it firmly fixed within the fuse holder.
  7. Reassemble the instrument properly followed by connecting all the cables and cords.
- 
8. Fuse replacement is completed.

## Battery Replacement

---

### Beforehand

This chapter describes the procedure of battery replacement in the front panel.

Before start, it is required to let a certified and trained technician properly aware of potential risks to disassemble instrument case. Unplug power cord and disconnect external circuit from the instrument before opening the case. Some of the electrical connections are dynamic and even available after powering off the instrument. Consequently, Do disconnect all the inputs, cords and cables before disassembling the instrument.

### The steps to replace battery

1. Power off properly and disconnect all the test leads, cables including power cord.
2. Disassemble the instrument case in light of the disassembling instructions.
3. Find the battery (CR2032) on the main board, which is perfectly located in the BT101 behind the transformer.





4. Gently remove the metal guard plate on top of the battery as the figure shown.

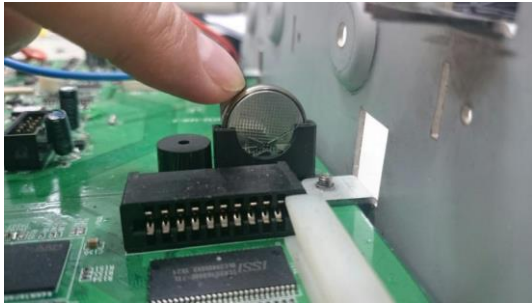

5. Pinch the battery out off the compartment with 2 fingers.

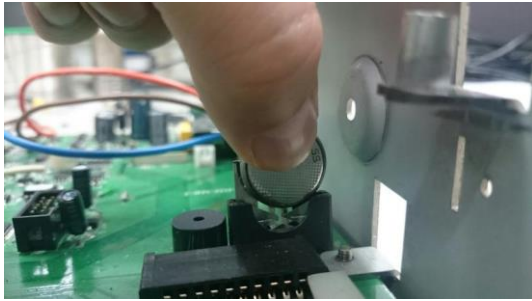

6. Remove the battery and dispose or recycle it in accord with the applicable regulations.
7. Place the new battery (CR2032) into the compartment and beware of the polarity (+, -). “+” is way close to the metal guard plate. Gently press the battery downwards to make it firmly fixed.
8. Connect every cable and cord in need and reassemble the instrument in proper order. The procedure of battery replacement is completed.

## Factory Default Parameters

Measurement		
Item List	Factory Default Parameter	Parameter Save/Load for Group 1 - 5
1ST Function	DCV	✓
1ST Range	Auto Range	✓
1ST Speed	5/s	✓
2ND Function	Off	✓
DCV Ratio	Off	✓
Filter	On	✓
Filter Type	Move	✓
Filter Count	10	✓
Filter Windows	0.10%	✓
Filter Method	Measure	✓
Auto Zero	On	✓
Input Impedance	10M(fixed for DCV)	✓
AC Speed (Bandwidth)	5/s(20Hz)	✓
Freq GetTime	100ms	✓
Freq InJack	Voltage	✓
Freq Timeout	1sec	✓
Continuity Threshold	10Ω	✓
Continuity Beep Volume	Small	✓

Temperature			
Item List		Factory Default Parameter	Parameter Save/ Load for Group 1 - 5
Probe		Themocouple	✓
Unit		°C	✓
	Type	J	✓
Themocouple	Simulated Method	Auto	✓
	Simulated junction	23	✓
	Auto Simulated ADJ	0	✓
RTD	Type	PT100	✓
	R0	100	✓
Thermistor	Type	5kΩ	✓
Display			
Item List		Factory Default Parameter	Parameter Save/ Load for Group 1 - 5
Digit		Auto	✓
Display		Number	✓
Bar Meter	Scale	Normal	✓
	VScale	Normal	✓
TrendChart	HScale	Count	✓
	Recent HScale	400sec	✓
Histogram	Bins	100	✓
	HScale	Auto	✓
Math			

Item List	Factory Default Parameter	Parameter Save/ Load for Group 1 - 5	
Math Function	Off	✓	
Math Display	Off	✓	
	Function	Off	✓
Hold	Beep Volume	Small	✓
	Threshold	0.10%	✓
Rel	Function	Off	✓
	Reference Method	dBm	✓
dB	Reference Resistance	600Ω	✓
	Reference Resistance	600Ω	✓
Compare	Beep Mode	Off	✓
	Beep Volume	Medium	✓
	Low Limit	-1	✓
	High Limit	1	✓
MX+B	M Value	1	✓
	B Value	0	✓
Trigger			
Item List	Factory Default Parameter	Parameter Save/ Load for Group 1 - 5	
Trigger Source	Auto	✓	
Trigger Delay	Auto	✓	
Trigger Signal	NEG	✓	
Sample Count	1	✓	
EOM Out	NEG	✓	

Menu			
Item List	Factory Default	Parameter	Parameter Save/ Load for Group 1 - 5
System	Beep	On	✓
	Key Sound	On	✓
	Internet Time Sync	Disable	✗
	FREQ Compensate	Enable	✗
	Lab Password	Enable	✗
Display	Brightness	60%	✓
	AutoOff	OFF	✓
	AutoOff Time	30min	✓
	1ST Font Color	White	✓
	2ND Font Color	White	✓
	Math Font Color	White	✓
	Math Off Display Mode	Off	✓
	Antialiasing	Off	✓
	Additional Info	All On	✓
	Languge	English	✗
Interface	Interface	RS232	✗
	BaudRate	115200	✗
	FlowCtrl	Off	✗
	EOL Character	CR+LF	✗
	Separation Character	Comma	✗
	USB Protocol	USBCDC	✗
	GPIB Address	15	✗

Lan	Identity	Default	✗
	DHCP	ON	✗
	Web	ON	✗
	Telnet	ON	✗
	Telnet Port	3000	✗
	Telnet Echo	ON	✗
	TCP	ON	✗
	TCP Port	3001	✗



Only utilized parameters are listed here due to over-amount parameters. The rest of the parameters unlisted, however, can be saved and loaded as well.



It indicates parameters can be saved and loaded from the groups 1 to 5.



It indicates the independent save zone which is free from impact of reboot.

# Specifications

## General

This section lists the general characteristics of the instrument.



Note:

- All specifications are ensured only under a single display.
- At least 1 hour of warm-up time is required before applying these specifications.
- Make sure that the Sense LO terminal to Input LO is limited to 2Vpk, the Sense HI to Sense LO terminals are limited to 200Vpk and the Input LO to earth is limited to 500Vpk. CAT II 300V. MAX DC1000V, AC 750V

Line Power	<ul style="list-style-type: none"> <li>• Power Supply: 100 / 120 / 220 / 240 VAC <math>\pm 10\%</math></li> <li>• Power Line Frequency: 50 Hz / 60 Hz / 400 Hz <math>\pm 10\%</math></li> <li>• Power Consumption: Max. 25 VA</li> </ul>
Environment	<ul style="list-style-type: none"> <li>• Operating Environment: Full accuracy for 0 °C to 55 °C</li> <li>• Full accuracy to 80% R.H. at 40 °C Non-condensing</li> <li>• Operating Altitude Up to 2,000 m</li> <li>• Storage Temperature -40 to 70 °C</li> </ul>
Mechanical	<ul style="list-style-type: none"> <li>• Rack Dimensions: 88mm(H) X 220mm(W) X 276.6mm(D) (without bumpers)</li> <li>• Bench Dimensions: 107mm(H) X 266.9mm(W) X 301.8mm(D) (with bumpers)</li> <li>• Weight (9060): 3.30 kg (7.3 lbs)</li> <li>• Weight (9061): 3.53 kg (7.8lbs)</li> </ul>
Display	<ul style="list-style-type: none"> <li>• 4.3" color TFT WQVGA (480x272) with LED backlight</li> <li>• Supports basic number, bar meter, trend chart</li> </ul>



---

and histogram views

---

Temperature Coefficient	<ul style="list-style-type: none"><li>• Increment of one coefficient per one degree celsius when the range is beyond TCAL <math>\pm 5</math> °C.</li></ul>
Accuracy Specification	<ul style="list-style-type: none"><li>• It is relevant to the calibration standard.</li></ul>
Real-Time Clock/Calendar	<ul style="list-style-type: none"><li>• Set and read, year, month, day, hour, minute, seconds</li><li>• Battery CR-2032 coin-type, replaceable</li></ul>

---



# RSDM-9061

## DC Characteristics<sup>[1]</sup>

### DC Voltage

Range <sup>[2]</sup>	24 Hour TCAL ± 1 °C	90 Day TCAL ± 5 °C	1 Year TCAL ± 5 °C	Temperature Coefficient/°C
100.0000 mV	0.0030 + 0.0030	0.0040 + 0.0035	0.0050 + 0.0035	0.0005 + 0.0005
1.000000 V	0.0020 + 0.0006	0.0035 + 0.0007	0.0048 + 0.0007	0.0005 + 0.0001
10.00000 V	0.0015 + 0.0004	0.0020 + 0.0005	0.0035 + 0.0005	0.0005 + 0.0001
100.0000 V	0.0020 + 0.0006	0.0035 + 0.0006	0.0050 + 0.0006	0.0005 + 0.0001
1000.000 V	0.0025 + 0.0006	0.0040 + 0.0010	0.0050 + 0.0010	0.0005 + 0.0001

Accuracy Specifications: ± ( % of reading + % of range )

### Resistance <sup>[3]</sup>

Range <sup>[2]</sup>	Test Current	24 Hour TCAL ± 1 °C	90 Day TCAL ± 5 °C	1 Year TCAL ± 5 °C	Temperature Coefficient/°C
100.0000 Ω	1 mA	0.003 + 0.0030	0.008 + 0.004	0.010 + 0.004	0.0008+ 0.0005
1.000000 kΩ	1 mA	0.002 + 0.0005	0.008 + 0.001	0.010 + 0.001	0.0008+ 0.0001
10.00000 kΩ	100 μA	0.002 + 0.0005	0.008 + 0.001	0.010 + 0.001	0.0008+ 0.0001
100.0000 kΩ	10 μA	0.002 + 0.0005	0.008 + 0.001	0.010 + 0.001	0.0008+ 0.0001
1.000000 MΩ	5 μA	0.002 + 0.0010	0.008 + 0.001	0.010 + 0.001	0.0010+ 0.0002
10.00000 MΩ	500 nA	0.015 + 0.0010	0.020 + 0.001	0.040 + 0.001	0.0030+ 0.0004
100.0000 MΩ	500 nA //10 MΩ	0.300 + 0.0100	0.800 + 0.010	0.800 + 0.010	0.1500+ 0.0002

Accuracy Specifications: ± ( % of reading + % of range )

### DC Current

Range <sup>[2]</sup>	Burden Voltage	24 Hour TCAL ± 1 °C	90 Day TCAL ± 5 °C	1 Year TCAL ± 5 °C	Temperature Coefficient/°C
100.0000 μA	< 0.11 V	0.010 + 0.020	0.040 + 0.025	0.050 + 0.025	0.002 + 0.003
1.000000 mA	< 0.11 V	0.007 + 0.006	0.030 + 0.006	0.050 + 0.006	0.002 + 0.001
10.00000 mA	< 0.04 V	0.007 + 0.020	0.030 + 0.020	0.050 + 0.020	0.002 + 0.002
100.0000 mA	< 0.4 V	0.010 + 0.004	0.030 + 0.005	0.050 + 0.005	0.002 + 0.001



1.000000 A	< 0.7 V	0.050 + 0.006	0.080 + 0.010	0.100 + 0.010	0.005 + 0.001
3.000000 A	< 2.0 V	0.180 + 0.020	0.200 + 0.020	0.200 + 0.020	0.005 + 0.002
10.000000 A <sup>[6]</sup>	< 0.5 V	0.100 + 0.010	0.120 + 0.010	0.150 + 0.010	0.005 + 0.001

Accuracy Specifications: ± ( % of reading + % of range )

### Continuity

Range <sup>[2]</sup>	24 Hour	90 Day	1 Year	Temperature Coefficient/°C
1 kΩ	0.002 + 0.030	0.008 + 0.030	0.01 + 0.03	0.001 + 0.002

Accuracy Specifications: ± ( % of reading + % of range )

### Diode Test<sup>[4]</sup>

Range <sup>[2]</sup>	24 Hour	90 Day	1 Year	Temperature Coefficient/°C
5 V	0.002 + 0.030	0.008 + 0.030	0.01 + 0.03	0.001 + 0.002

Accuracy Specifications: ± ( % of reading + % of range )

### DCV Ratio<sup>[5]</sup>

Accuracy Specification: ± (DC Input accuracy + DC Reference accuracy)

## Measuring Characteristics

DC Voltage	Input Resistance Range	
	100 mV	10 MΩ or >10 GΩ
1 V		
10 V		
100 V	10 MΩ ± 1%	
1000 V		
Input Bias	30 pA (Typ, 25°C)	
Input Protection	1000 V on all ranges	

Measurement Method: Sigma-delta A/D Converter

Resistance	Max. Lead Resistance	Input Protection
	10% of range per lead for 100Ω, 1 kΩ ranges. 1 kΩ per lead on all other ranges.	1000 V on all ranges

Measurement Method: Selectable 4-wire or 2-wire ohms. Current source referenced to Input LO Terminal

DC Current	Range	Shunt	Burden Voltage
	100 $\mu$ A	100 $\Omega$	<0.011 V
	1 mA	100 $\Omega$	<0.11 V
	10 mA	1 $\Omega$	<0.04 V
	100 mA	1 $\Omega$	<0.4 V
	1 A	0.1 $\Omega$	<0.7 V
	3 A	0.1 $\Omega$	<2 V
	10 A	10m $\Omega$	<0.5 V
Input Protection		External 3.15 A, 500 V fuse for 3 A Internal 6 A, 1 kV fuse for 3 A Internal 12 A, 1 kV fuse for 10 A	

Reading Rate (Readings/sec)		Speed	Digits
	DCV	5 /s , 20 /s , 60 /s , 100 /s	6 ½
	DCI	400 /s , 1.2 k /s , 2.4 k /s	5 ½
	2W/4W-Resistance	4.8 k /s , 7.5 k /s , 10 k/s	4 ¼
		Speed	Digits
	Continuity	60 /s	6 ½
Diode	100 /s	5 ½	
	400 /s	4 ¼	

<sup>[1]</sup>DC Specification: In addition to the availability that requires warm-up of 60 minutes, it must be set in 5/s speed rate (60/s speed rate for Continuity and Diode), A-Zero on.

<sup>[2]</sup>The entire range of measurement will pass the set range by 20% except the tests of 1000 V DC, 3 A DC, 10 A DC and diode.

<sup>[3]</sup>This specification applies to 4-wire resistance measurement, whilst it requires using "REL" function for offset on 2-wire resistance measurement. 2-wire resistance measurement will cause additional error of 0.2 $\Omega$  if REL function is not executed.

<sup>[4]</sup>This specification applies to the voltage measured from input terminal. 1 mA test current is the typical value. The change of current source leads to the variation in buck of diode junction.

<sup>[5]</sup>Accuracy is  $\pm$  (DC Input accuracy + DC Reference accuracy), where Input accuracy = DC Voltage accuracy for the Input HI to LO (in % of the Input voltage), and Reference accuracy = DC Voltage accuracy for the HI to LO (Sense) Reference (in % of the Reference voltage).

<sup>[6]</sup>The 10 A range of measurement is available for the terminals on front panel only. Due to power factor resulting in temperature rise, 2 mA increment per one ampere when input is greater than 5 A.



## AC Characteristics<sup>[1]</sup>

### True RMS AC Voltage<sup>[2] [3] [4]</sup>

Range [2]	Frequency	24 Hour TCAL ± 1 °C	90 Day TCAL ± 5 °C	1 Year TCAL ± 5 °C	Temperature Coefficient/°C
100 mV	3 Hz - 5 Hz	1.00 + 0.03	1.00 + 0.04	1.00 + 0.04	0.100 + 0.004
	5 Hz - 10 Hz	0.35 + 0.03	0.35 + 0.04	0.35 + 0.04	0.035 + 0.004
	10 Hz - 20 kHz	0.04 + 0.03	0.05 + 0.04	0.06 + 0.04	0.005 + 0.003
	20 kHz - 50 kHz	0.10 + 0.05	0.11 + 0.05	0.12 + 0.05	0.011 + 0.005
	50 kHz - 100 kHz	0.55 + 0.08	0.60 + 0.08	0.60 + 0.08	0.060 + 0.008
	100 kHz - 300 kHz	4.00 + 0.50	4.00 + 0.50	4.00 + 0.50	0.200 + 0.020
1 V ~ 750 V	3 Hz - 5 Hz	1.00 + 0.02	1.00 + 0.03	1.00 + 0.03	0.100 + 0.004
	5 Hz - 10 Hz	0.35 + 0.02	0.35 + 0.03	0.35 + 0.03	0.035 + 0.004
	10 Hz - 20 kHz	0.04 + 0.02	0.05 + 0.03	0.06 + 0.03	0.005 + 0.003
	20 kHz - 50 kHz	0.10 + 0.04	0.11 + 0.05	0.12 + 0.05	0.011 + 0.005
	50 kHz - 100 kHz	0.55 + 0.08	0.60 + 0.08	0.60 + 0.08	0.060 + 0.008
	100 kHz - 300 kHz	4.00 + 0.50	4.00 + 0.50	4.00 + 0.50	0.200 + 0.020

Accuracy Specifications: ± ( % of reading + % of range )

### True RMS AC Current<sup>[2] [4] [5]</sup>

Range [2]	Burden Voltage	Frequency	24 Hour TCAL ± 1 °C	90 Day TCAL ± 5 °C	1 Year TCAL ± 5 °C	Temperature Coefficient/°C
100 µA/	<0.011 V,	3Hz~5 Hz	1.00 + 0.04	1.00 + 0.04	1.00 + 0.04	0.100 + 0.006
10 mA	<0.04 V	5Hz~10Hz	0.35 + 0.04	0.35 + 0.04	0.35 + 0.04	0.035 + 0.006
		10Hz~5kHz	0.10 + 0.04	0.10 + 0.04	0.10 + 0.04	0.015 + 0.006
		5kHz~ 10kHz	0.18 + 0.04	0.18 + 0.04	0.18 + 0.04	0.030 + 0.006
		1 mA/	<0.11 V,	3Hz~5Hz	1.00 + 0.04	1.00 + 0.04
100 mA	<0.4 V	5Hz~10Hz	0.30 + 0.04	0.30 + 0.04	0.30 + 0.04	0.035 + 0.006
		10Hz~ 5 kHz	0.10 + 0.04	0.10 + 0.04	0.10 + 0.04	0.015 + 0.006
		5kHz~ 10 kHz	0.15 + 0.04	0.15 + 0.04	0.15 + 0.04	0.030 + 0.006
		1 A	< 0.7 V	3 Hz – 5 Hz	1.00 + 0.04	1.00 + 0.04
		5 Hz – 10	0.30 + 0.04	0.30 + 0.04	0.30 + 0.04	0.035 + 0.006

		Hz				
		10 Hz – 5	0.10 + 0.04	0.10 + 0.04	0.10 + 0.04	0.015 + 0.006
		kHz				
		5 kHz – 10	0.15 + 0.04	0.15 + 0.04	0.15 + 0.04	0.030 + 0.006
		kHz				
3 A	< 2.0 V	3 Hz – 5	1.00 + 0.04	1.00 + 0.04	1.00 + 0.04	0.100 + 0.006
		Hz				
		5 Hz – 10	0.35 + 0.04	0.35 + 0.04	0.35 + 0.04	0.035 + 0.006
		Hz				
		10 Hz – 5	0.23 + 0.04	0.23 + 0.04	0.23 + 0.04	0.015 + 0.006
		kHz				
		5 kHz – 10	0.23 + 0.04	0.23 + 0.04	0.23 + 0.04	0.030 + 0.006
		kHz				
10 A [6]	< 0.5 V	3 Hz – 5	1.10 + 0.04	1.10 + 0.04	1.10 + 0.04	0.100 + 0.006
		Hz				
		5 Hz – 10	0.35 + 0.04	0.35 + 0.04	0.35 + 0.04	0.035 + 0.006
		Hz				
		10 Hz – 5	0.15 + 0.04	0.15 + 0.04	0.15 + 0.04	0.015 + 0.006
		kHz				
		5 kHz – 10	0.35 + 0.04	0.35 + 0.04	0.35 + 0.04	0.030 + 0.006
		kHz				

Accuracy Specifications:  $\pm$  ( % of reading + % of range )

#### Additional Crest Factor Errors (non-sine wave)

Crest Factor	Error (% of reading)
1-2	0.05%
2-3	0.15%
3-4	0.30%
4-5	0.40%

#### Additional Low Frequency Errors (% of reading)

Frequency	Speed		
	1/s (>3 Hz)	5/s (>20 Hz)	20/s (>200 Hz)
10 Hz~20 Hz	0	0.74	-
20 Hz~40 Hz	0	0.22	-
40 Hz~100 Hz	0	0.06	0.73
100 Hz~200 Hz	0	0.01	0.22
200 Hz~1 k Hz	0	0	0.18

>1 k Hz	0	0	0
---------	---	---	---

## Measuring Characteristics

True RMS AC Voltage	Measurement Method:	AC-coupled True RMS – measures the ac component of input with up to 400 Vdc of bias on any range.	
	Crest Factor	Maximum 5:1 at full scale	
AC Bandwidth	Speed	Bandwidth	
	1/s (>3 Hz)	3 Hz – 300 kHz (ACI:3 Hz – 10 kHz)	
	5/s (>20 Hz)	20 Hz – 300 kHz (ACI:20 Hz – 10 kHz)	
	20/s (>200 Hz)	200 Hz – 300 kHz (ACI:200 Hz – 10 kHz)	
	Input Impedance:	1 M $\Omega$ $\pm$ 2%, in parallel with 100 pF	
	Input Protection: 750 Vrms on all ranges		
True RMS AC Current	Range	Shunt	Burden Voltage
	100 $\mu$ A	100 $\Omega$	<0.011 V
	1 mA	100 $\Omega$	<0.11 V
	10 mA	1 $\Omega$	<0.04 V
	100 mA	1 $\Omega$	<0.4 V
	1 A	0.1 $\Omega$	<0.7 V
	3 A	0.1 $\Omega$	<2 V
	10 A	10 m $\Omega$	<0.5 V
	Input Protection: External 3.15 A, 500 V fuse for 3 A Internal 6 A, 1 kV fuse for 3 A Internal 12 A, 1 kV fuse for 10 A		

## Operating Characteristics

Function	Speed	Digits	AC Bandwidth
ACV	1/s (>3 Hz)	6 ½	3 Hz – 300 kHz
	5/s (>20 Hz)	5 ½	20 Hz – 300 kHz
	20/s (>200 Hz)	4 ½	200 Hz – 300 kHz
ACI	1/s (>3 Hz)	6 ½	3 Hz – 10 kHz
	5/s (>20 Hz)	5 ½	20 Hz – 10 kHz
	20/s (>200 Hz)	4 ½	200 Hz – 10 kHz

AC Specification: It will be available after 60 minutes of warm-up, sine wave as well as 1/s speed rate.

The entire range of measurement will pass the set range by 20% except the tests of 750 VAC, 3 A AC and 10 A AC.

Specifications are for sinewave input >5% of range. For inputs from 1% to 5% of range and <50 kHz, add 0.1% of range additional error. For 50 kHz to 100 kHz, add 0.13% of range. The measurement range of 750 VAC is limited within the range of  $7.5 \times 10^7$  Volt-Hz.

Three speed settings provided for low-frequency performance: 1/s (3 Hz), 5/s (20 Hz), 20/s (200 Hz). Additional errors will Not occur for the frequency greater than the filter settings.

Specifications are for sinewave input >5% of range, and is beyond  $10 \mu$  A AC. For inputs from 1% to 5% of range, add 0.1% of range additional error.

The 10A range of measurement is available for the terminals on front panel only. Due to power factor resulting in temperature rise, 2 mA increment per one ampere when input is greater than 5 A rms.

## Frequency and Period Characteristics

Frequency Period [1] [2]

Range	Frequency	24 Hour TCAL $\pm 1^\circ\text{C}$	90 Day TCAL $\pm 5^\circ\text{C}$	1 Year TCAL $\pm 5^\circ\text{C}$	Temperature Coefficient/ $^\circ\text{C}$
100 mV~	3 Hz – 5 Hz	0.100	0.100	0.100	0.100
750 V [3]	5 Hz – 10 Hz	0.050	0.050	0.050	0.035
	10 Hz – 40 Hz	0.030	0.030	0.030	0.015
	40 Hz – 1 MHz <sup>[4]</sup>	0.006	0.006	0.006	0.015

Accuracy Specifications:  $\pm$  % of reading

## Measuring Characteristics

Frequency and Period	Measurement Method:	Reciprocal-counting technique. AC-coupled input using the ac voltage measurement function.
	Voltage Ranges	100 mVrms full scale to 750 Vrms. Auto or manual ranging.
Settling Considerations	Errors will occur when attempting to measure the frequency or period of an input following a dc offset voltage change. The input blocking RC time constant must be allowed to fully settle (up to 1 sec) before the most accurate measurements are possible.	
Measurement	All frequency counters are susceptible to error when	



Considerations	measuring low-voltage, low-frequency signals.
	Shielding inputs from external noise pickup is critical for minimizing measurement errors.

## Operating Characteristics

Function	Gate Time	Digits
Frequency, Period	1 s	6 ½
	100 ms	5 ½
	10 ms	4 ½

This specification will be available after 60 minutes of warm-up and sine wave input, unless stated otherwise. This specification applies to 1s gate time.

This specification is available when both sine wave and square wave input  $\geq 100$  mV. For the input of 10 mV to 100 mV, the % of reading error needs to be multiplied by 10 times.

The amplitude range is from 10% to 120% and is lower than 750 VAC.

The input  $\geq 60$  mV, for 300 k ~ 1 MHz, within 100mV range.

## Temperature Characteristics<sup>[1]</sup> (Exclusive of probe errors)

RTD (Accuracy based on PT100):

(100  $\Omega$  platinum [PT100], D100, F100, PT385, PT3916, or user type)

Range	Resolution	1 Year (23°C $\pm 5^\circ\text{C}$ )	Temperature Coefficient 0°-18°C & 28°-55°C
-200 °C ~ -100 °C	0.001 °C	0.09 °C	0.004 °C / °C
-100 °C ~ -20 °C	0.001 °C	0.08 °C	0.005 °C / °C
-20 °C ~ -20 °C	0.001 °C	0.06 °C	0.005 °C / °C
20 °C ~ 100 °C	0.001 °C	0.08 °C	0.005 °C / °C
100 °C ~ 300 °C	0.001 °C	0.12 °C	0.007 °C / °C
300 °C ~ 600 °C	0.001 °C	0.22 °C	0.009 °C / °C

Thermocouples (Accuracy based on ITS-90):

Type	Range	Resolution	90 Day/1 Year (23 °C $\pm 5^\circ\text{C}$ )*	Temperature Coefficient 0°-18 °C & 28°-55 °C
E	-200 to +1000 °C	0.002 °C	0.2 °C	0.03 °C / °C
J	-210 to +1200 °C	0.002 °C	0.2 °C	0.03 °C / °C
T	-200 to +400 °C	0.002 °C	0.3 °C	0.04 °C / °C



K	-200 to +1372 °C	0.002 °C	0.3 °C	0.04 °C / °C
N	-200 to +1300 °C	0.003 °C	0.4 °C	0.05 °C / °C
R	-50 to +1768 °C	0.01 °C	1 °C	0.14 °C / °C
S	-50 to +1768 °C	0.01 °C	1 °C	0.14 °C / °C
B	+350 to +1820 °C	0.01 °C	1 °C	0.14 °C / °C

\*Relative to simulated junction

Thermistor: (2.2 kΩ, 5 kΩ, 10 kΩ or User Type)

Range	Resolution	90 Day/1 Year (23 °C±5 °C)*	Temperature Coefficient / °C
-80 ° to 150 °C	0.001 °C	0.1 °C	0.003 °C/ °C

Reading Rate (Readings/sec)	TCO/RTD/ Thermistor	Speed	Digits
		5/s	6 ½
		20/s	5 ½
		60/s	4 ½

The actual measurement range and test lead error will be constrained by the adopted test lead. The test lead accuracy adder covers all errors of measurements and ITS-90 temperature change.

Capacitance [1]

Range	24 Hour TCAL ± 1 °C	90 Day TCAL ± 5 °C	1 Year TCAL ± 5 °C	Temperature Coefficient/ °C
1.000 nF	2.00 + 2.00	2.00 + 2.00	2.00 + 2.00	0.05 + 0.01
10.00 nF	2.00 + 1.00	2.00 + 1.00	2.00 + 1.00	0.05 + 0.01
100.0 nF	2.00 + 0.40	2.00 + 0.40	2.00 + 0.40	0.05 + 0.01
1.000 μF	2.00 + 0.40	2.00 + 0.40	2.00 + 0.40	0.05 + 0.01
10.00 μF	2.00 + 0.40	2.00 + 0.40	2.00 + 0.40	0.05 + 0.01
100.0 μF	2.00 + 0.40	2.00 + 0.40	2.00 + 0.40	0.05 + 0.01

Accuracy Specifications: ± ( % of reading + % of range )

Specifications are for film Capacitance inputs that are greater than 10% range.

## Capacitance

---

Measurement method: DC recharge & discharge.

---

Input protection: 500 V<sub>peak</sub> on all ranges.

---

The capacitor under test ( $C_x$ ) is charged using a constant current source. The time to charge  $C_x$  is recorded. The capacitor is then discharged using a known resistance and the discharge time is recorded. The value of the resistance depends on the capacitance range that is selected. The charge and discharge time is used to calculate the capacitance of  $C_x$  if the selected capacitance range is equal to or less than 10 nF. Only the charge time is used to calculate the capacitance of  $C_x$  if the selected capacitance range is equal to or greater than 100 nF.

As measuring capacitance with the DMM is effectively a DC measurement, the measured capacitance tends to be higher than what is measured by LCR meters. For best measurement results, first perform a zeroing of the test leads when the cables are “open” to compensate for the test lead capacitance.

# RSDM-9060

## DC Characteristics<sup>[1]</sup>

### DC Voltage

Range <sup>[2]</sup>	24 Hour TCAL ± 1 °C	90 Day TCAL ± 5 °C	1 Year TCAL ± 5 °C	Temperature Coefficient/°C
100.0000 mV	0.0040 + 0.0060	0.0070 + 0.0065	0.0090 + 0.0065	0.0005 + 0.0005
1.000000 V	0.0030 + 0.0009	0.0060 + 0.0010	0.0080 + 0.0010	0.0005 + 0.0001
10.00000 V	0.0025 + 0.0004	0.0050 + 0.0005	0.0075 + 0.0005	0.0005 + 0.0001
100.0000 V	0.0030 + 0.0006	0.0065 + 0.0006	0.0085 + 0.0006	0.0005 + 0.0001
1000.000 V	0.0030 + 0.0006	0.0065 + 0.0010	0.0085 + 0.0010	0.0005 + 0.0001

Accuracy Specifications: ± (% of reading + % of range )

### Resistance<sup>[3]</sup>

Range <sup>[2]</sup>	Test Current	24 Hour TCAL ± 1 °C	90 Day TCAL ± 5 °C	1 Year TCAL ± 5 °C	Temperature Coefficient/°C
100.0000 Ω	1 mA	0.004 + 0.0060	0.011 + 0.007	0.014 + 0.007	0.0006 + 0.0005
1.000000 kΩ	1 mA	0.003 + 0.0008	0.011 + 0.001	0.014 + 0.001	0.0006 + 0.0001
10.00000 kΩ	100 μA	0.003 + 0.0005	0.011 + 0.001	0.014 + 0.001	0.0006 + 0.0001
100.0000 kΩ	10 μA	0.003 + 0.0005	0.011 + 0.001	0.014 + 0.001	0.0006 + 0.0001
1.000000 MΩ	5 μA	0.003 + 0.0010	0.011 + 0.001	0.014 + 0.001	0.0010 + 0.0002
10.00000 MΩ	500 nA	0.015 + 0.0010	0.020 + 0.001	0.040 + 0.001	0.0030 + 0.0004
100.0000 MΩ	500 nA //10 MΩ	0.300 + 0.0100	0.800 + 0.010	0.800 + 0.010	0.1500 + 0.0002

Accuracy Specifications: ± (% of reading + % of range )

### DC Current

Range <sup>[2]</sup>	Burden Voltage	24 Hour TCAL ± 1 °C	90 Day TCAL ± 5 °C	1 Year TCAL ± 5 °C	Temperature Coefficient/°C
100.0000 μA	< 0.011V	0.010 + 0.020	0.040 + 0.025	0.050 + 0.025	0.0020 + 0.0030
1.000000 mA	< 0.11 V	0.007 + 0.006	0.030 + 0.006	0.050 + 0.006	0.0020 + 0.0005
10.00000 mA	< 0.04 V	0.007 + 0.020	0.030 + 0.020	0.050 + 0.020	0.0020 + 0.0020
100.0000 mA	< 0.4 V	0.010 + 0.004	0.030 + 0.005	0.050 + 0.005	0.0020 + 0.0005



---

1.000000 A < 0.7 V 0.050 + 0.006 0.080 + 0.010 0.100 + 0.010 0.0050 + 0.0010

3.000000 A < 2.0 V 0.180 + 0.020 0.200 + 0.020 0.200 + 0.020 0.0050 + 0.0020

---

Accuracy Specifications:  $\pm$  ( % of reading + % of range )

### Continuity

Range <sup>[2]</sup>	24 Hour TCAL $\pm$ 1 °C	90 Day TCAL $\pm$ 5 °C	1 Year TCAL $\pm$ 5 °C	Temperature Coefficient/°C
1 k $\Omega$	0.003 + 0.030	0.011 + 0.030	0.014 + 0.030	0.001 + 0.002

Accuracy Specifications:  $\pm$  ( % of reading + % of range )

### Diode Test <sup>[4]</sup>

Range <sup>[2]</sup>	24 Hour TCAL $\pm$ 1 °C	90 Day TCAL $\pm$ 5 °C	1 Year TCAL $\pm$ 5 °C	Temperature Coefficient/°C
5 V	0.003 + 0.030	0.011 + 0.030	0.014 + 0.030	0.0010 + 0.0020

Accuracy Specifications:  $\pm$  ( % of reading + % of range )

### DCV Ratio <sup>[5]</sup>

Accuracy Specification:  $\pm$  (DC Input accuracy + DC Reference accuracy)

---

## Measuring Characteristics

DC Voltage	Input Resistance Range	
	100 mV	10 M $\Omega$ or >10 G $\Omega$
1 V	Selectable	
10 V		
100 V	10 M $\Omega$ $\pm$ 1%	
1000 V		
Input Bias	30 pA (Typ, 25°C)	
Input Protection	1000 V on all ranges	

Measurement Method: Sigma-delta A/D Converter

Resistance	Max. Lead Resistance	10% of range per lead for 100 $\Omega$ , 1 k $\Omega$ ranges. 1 k $\Omega$ per lead on all other ranges.
	Input Protection	1000 V on all ranges

Measurement Method: Selectable 4-wire or 2-wire ohms. Current source

referenced to Input LO Terminal

	Range	Shunt	Burden Voltage
<b>DC Current</b>	100 $\mu$ A	100 $\Omega$	<0.011 V
	1 mA	100 $\Omega$	<0.11 V
	10 mA	1 $\Omega$	<0.04 V
	100 mA	1 $\Omega$	<0.4 V
	1 A	0.1 $\Omega$	<0.7 V
	3 A	0.1 $\Omega$	<2 V
	Input Protection	External 3.15 A, 500 V fuse for 3 A Internal 6 A, 1 kV fuse for 3 A	
<b>Reading Rate (Readings/sec)</b>		Speed	Digits
	DCV	5 /s, 20 /s, 60 /s, 100 /s	6 ½
	DCI, 2W/4W-Resistance	400 /s, 1 k /s	5 ½
		Speed	Digits
	Continuity Diode	60 /s	6 ½
		100 /s	5 ½
		400 /s	4 ¼

<sup>[1]</sup>DC Specification: In addition to the availability that requires warm-up of 60 minutes, it must be set in 5/s speed rate (60/s speed rate for Continuity and Diode), A-Zero on.

<sup>[2]</sup>The entire range of measurement will pass the set range by 20% except the tests of 1000 V DC, 3 A DC, 10 A DC and diode.

<sup>[3]</sup>This specification applies to 4-wire resistance measurement, whilst it requires using "REL" function for offset on 2-wire resistance measurement. 2-wire resistance measurement will cause additional error of 0.2 $\Omega$  if REL function is not executed.

<sup>[4]</sup>This specification applies to the voltage measured from input terminal. 1 mA test current is the typical value. The change of current source leads to the variation in buck of diode junction.

<sup>[5]</sup>Accuracy is  $\pm$  (DC Input accuracy + DC Reference accuracy), where Input accuracy = DC Voltage accuracy for the Input HI to LO (in % of the Input voltage), and Reference accuracy = DC Voltage accuracy for the HI to LO (Sense) Reference (in % of the Reference voltage).

## AC Characteristics<sup>[1]</sup>

### True RMS AC Voltage<sup>[2] [3] [4]</sup>

Range [2]	Frequency	24 Hour TCAL ± 1 °C	90 Day TCAL ± 5 °C	1 Year TCAL ± 5 °C	Temperature Coefficient/°C
100 mV	3 Hz - 5 Hz	1.00 + 0.03	1.00 + 0.04	1.00 + 0.04	0.100 + 0.004
	5 Hz - 10 Hz	0.35 + 0.03	0.35 + 0.04	0.35 + 0.04	0.035 + 0.004
	10 Hz - 20 kHz	0.04 + 0.03	0.05 + 0.04	0.06 + 0.04	0.005 + 0.003
	20 kHz - 50 kHz	0.10 + 0.05	0.11 + 0.05	0.12 + 0.05	0.011 + 0.005
	50 kHz - 100 kHz	0.55 + 0.08	0.60 + 0.08	0.60 + 0.08	0.060 + 0.008
	100 kHz - 300 kHz	4.00 + 0.50	4.00 + 0.50	4.00 + 0.50	0.200 + 0.020
1 V ~ 750 V	3 Hz - 5 Hz	1.00 + 0.02	1.00 + 0.03	1.00 + 0.03	0.100 + 0.004
	5 Hz - 10 Hz	0.35 + 0.02	0.35 + 0.03	0.35 + 0.03	0.035 + 0.004
	10 Hz - 20 kHz	0.04 + 0.02	0.05 + 0.03	0.06 + 0.03	0.005 + 0.003
	20 kHz - 50 kHz	0.10 + 0.04	0.11 + 0.05	0.12 + 0.05	0.011 + 0.005
	50 kHz - 100 kHz	0.55 + 0.08	0.60 + 0.08	0.60 + 0.08	0.060 + 0.008
	100 kHz - 300 kHz	4.00 + 0.50	4.00 + 0.50	4.00 + 0.50	0.200 + 0.020

Accuracy Specifications: ± ( % of reading + % of range )

### True RMS AC Current<sup>[2] [4] [5]</sup>

Range [2]	Burden Voltage	Frequency	24 Hour TCAL ± 1 °C	90 Day TCAL ± 5 °C	1 Year TCAL ± 5 °C	Temperature Coefficient/°C
100 μA/	<0.011 V,	3Hz~5 Hz	1.00 + 0.04	1.00 + 0.04	1.00 + 0.04	0.100 + 0.006
10 mA	<0.04 V	5Hz~10Hz	0.35 + 0.04	0.35 + 0.04	0.35 + 0.04	0.035 + 0.006
		10Hz~5kHz	0.10 + 0.04	0.10 + 0.04	0.10 + 0.04	0.015 + 0.006
		5kHz~ 10kHz	0.18 + 0.04	0.18 + 0.04	0.18 + 0.04	0.030 + 0.006
1 mA/	<0.11 V,	3Hz~5Hz	1.00 + 0.04	1.00 + 0.04	1.00 + 0.04	0.100 + 0.006
100 mA	<0.4 V	5Hz~10Hz	0.30 + 0.04	0.30 + 0.04	0.30 + 0.04	0.035 + 0.006
		10Hz~ 5kHz	0.10 + 0.04	0.10 + 0.04	0.10 + 0.04	0.015 + 0.006
		5kHz~ 10kHz	0.15 + 0.04	0.15 + 0.04	0.15 + 0.04	0.030 + 0.006
		3Hz~5 Hz	1.00 + 0.04	1.00 + 0.04	1.00 + 0.04	0.100 + 0.006
1 A	< 0.7 V	5Hz~10Hz	0.30 + 0.04	0.30 + 0.04	0.30 + 0.04	0.035 + 0.006

		10Hz~5 kHz	0.10 + 0.04	0.10 + 0.04	0.10 + 0.04	0.015 + 0.006
		5 kHz~10 kHz	0.15 + 0.04	0.15 + 0.04	0.15 + 0.04	0.030 + 0.006
3 A	< 2.0 V	3Hz~5Hz	1.00 + 0.04	1.00 + 0.04	1.00 + 0.04	0.100 + 0.006
		5Hz~10Hz	0.35 + 0.04	0.35 + 0.04	0.35 + 0.04	0.035 + 0.006
		10 Hz ~5 kHz	0.23 + 0.04	0.23 + 0.04	0.23 + 0.04	0.015 + 0.006
		5 kHz ~ 10 kHz	0.23 + 0.04	0.23 + 0.04	0.23 + 0.04	0.030 + 0.006

Accuracy Specifications:  $\pm$  ( % of reading + % of range )

Additional Crest Factor Errors (non-sine wave)

Crest Factor	Error (% of reading)
1-2	0.05%
2-3	0.15%
3-4	0.30%
4-5	0.40%

Additional Low Frequency Errors (% of reading)

Frequency	Speed		
	1/s (>3 Hz)	5/s (>20 Hz)	20/s (>200 Hz)
10 Hz~20 Hz	0	0.74	-
20 Hz~40 Hz	0	0.22	-
40 Hz~100 Hz	0	0.06	0.73
100 Hz~200 Hz	0	0.01	0.22
200 Hz~1 k Hz	0	0	0.18
>1 k Hz	0	0	0

## Measuring Characteristics

True RMS AC Voltage	Measurement Method:	AC-coupled True RMS – measures the ac component of input with up to 400 Vdc of bias on any range.
	Crest Factor	Maximum 5:1 at full scale
AC Bandwidth	Speed	Bandwidth
	1/s (>3 Hz)	3 Hz – 300 kHz (ACI:3 Hz – 10 kHz)



5/s (>20 Hz)	20 Hz – 300 kHz (ACI:20 Hz – 10 kHz)
20/s(>200 Hz)	200 Hz – 300 kHz(ACI:200 Hz – 10 kHz)
Input Impedance:	1 MΩ ± 2%, in parallel with 100 pF
Input Protection: 750 Vrms on all ranges	

True RMS AC Current	Range	Shunt	Burden Voltage
	100 μA	100Ω	<0.011 V
	1 mA	100Ω	<0.11 V
	10 mA	1Ω	<0.04 V
	100 mA	1Ω	<0.4 V
	1 A	0.1Ω	<0.7 V
	3 A	0.1Ω	<2 V
	Input Protection: External 3.15 A, 500 V fuse for 3 A Internal 6 A, 1 kV fuse for 3 A		

## Operating Characteristics

Function	Speed	Digits	AC Bandwidth
ACV	1/s (>3 Hz)	6 ½	3 Hz – 300 kHz
	5/s (>20 Hz)	5 ½	20 Hz – 300 kHz
	20/s (>200 Hz)	4 ½	200 Hz – 300 kHz
ACI	1/s (>3 Hz)	6 ½	3 Hz – 10 kHz
	5/s (>20 Hz)	5 ½	20 Hz – 10 kHz
	20/s (>200 Hz)	4 ½	200 Hz – 10 kHz

<sup>[1]</sup>AC Specification: It will be available after 60 minutes of warm-up, sine wave as well as 1/s speed rate.

<sup>[2]</sup>The entire range of measurement will pass the set range by 20% except the tests of 750 VAC, 3 A AC and 10 A AC.

<sup>[3]</sup>Specifications are for sinewave input >5% of range. For inputs from 1% to 5% of range and <50 kHz, add 0.1% of range additional error. For 50 kHz to 100 kHz, add 0.13% of range. The measurement range of 750 VAC is limited within the range of  $7.5 \times 10^7$  Volt-Hz.

<sup>[4]</sup>Three speed settings provided for low-frequency performance: 1/s (3 Hz), 5/s (20 Hz), 20/s (200 Hz). Additional errors will Not occur for the frequency greater than the filter settings.

<sup>[5]</sup>Specifications are for sinewave input >5% of range, and is beyond 10 μ A AC. For inputs from 1% to 5% of range, add 0.1% of range additional error.

<sup>[6]</sup>The 10A range of measurement is available for the terminals on front panel



only. Due to power factor resulting in temperature rise, 2 mA increment per one ampere when input is greater than 5 A rms.

## Frequency and Period Characteristics

Frequency Period <sup>[1]</sup> <sup>[2]</sup>

Range	Frequency	24 Hour TCAL $\pm 1^\circ\text{C}$	90 Day TCAL $\pm 5^\circ\text{C}$	1 Year TCAL $\pm 5^\circ\text{C}$	Temperature Coefficient/ $^\circ\text{C}$
100 mV~	3 Hz – 5 Hz	0.100	0.100	0.100	0.100
750 V <sup>[3]</sup>	5 Hz – 10 Hz	0.050	0.050	0.050	0.035
	10 Hz – 40 Hz	0.030	0.030	0.030	0.015
	40 Hz – 1 MHz <sup>[4]</sup>	0.006	0.006	0.006	0.015

Accuracy Specifications:  $\pm$  % of reading

## Measuring Characteristics

Frequency and Period	Measurement Method:	Reciprocal-counting technique. AC-coupled input using the ac voltage measurement function.
	Voltage Ranges	100 mVrms full scale to 750 Vrms. Auto or manual ranging.
Settling Considerations		Errors will occur when attempting to measure the frequency or period of an input following a dc offset voltage change. The input blocking RC time constant must be allowed to fully settle (up to 1 sec) before the most accurate measurements are possible.
Measurement Considerations		All frequency counters are susceptible to error when measuring low-voltage, low-frequency signals. Shielding inputs from external noise pickup is critical for minimizing measurement errors.

## Operating Characteristics

Function	Gate Time	Digits
Frequency, Period	1 s	6 ½
	100 ms	5 ½
	10 ms	4 ½

<sup>[1]</sup>This specification will be available after 60 minutes of warm-up and sine wave input, unless stated otherwise. This specification applies to 1s gate time.



<sup>[2]</sup>This specification is available when both sine wave and square wave input  $\geq$  100 mV. For the input of 10 mV to 100 mV, the % of reading error needs to be multiplied by 10 times.

<sup>[3]</sup>The amplitude range is from 10% to 120% and is lower than 750 VAC.

<sup>[4]</sup>The input  $\geq$  60 mV, for 300 k ~ 1 MHz, within 100mV range.

## Temperature Characteristics<sup>[1]</sup> (Exclusive of probe errors)

RTD (Accuracy based on PT100):

(100Ω platinum [PT100], D100, F100, PT385, PT3916, or user type)

Range	Resolution	1 Year (23°C ±5°C)	Temperature Coefficient 0°-18°C & 28°-55°C
-200 °C~ -100 °C	0.001 °C	0.09 °C	0.004 °C / °C
-100 °C~-20 °C	0.001 °C	0.08 °C	0.005 °C / °C
-20 °C~-20 °C	0.001 °C	0.06 °C	0.005 °C / °C
20 °C~100 °C	0.001 °C	0.08 °C	0.005 °C / °C
100 °C~300 °C	0.001 °C	0.12 °C	0.007 °C / °C
300 °C~600 °C	0.001 °C	0.22 °C	0.009 °C / °C

Thermocouples (Accuracy based on ITS-90):

Type	Range	Resolution	90 Day/1 Year (23 °C±5 °C)*	Temperature Coefficient 0°-18 °C & 28°-55 °C
E	-200 to +1000 °C	0.002 °C	0.2 °C	0.03 °C / °C
J	-210 to +1200 °C	0.002 °C	0.2 °C	0.03 °C / °C
T	-200 to +400 °C	0.002 °C	0.3 °C	0.04 °C / °C
K	-200 to +1372 °C	0.002 °C	0.3 °C	0.04 °C / °C
N	-200 to +1300 °C	0.003 °C	0.4 °C	0.05 °C / °C
R	-50 to +1768 °C	0.01 °C	1 °C	0.14 °C / °C
S	-50 to +1768 °C	0.01 °C	1 °C	0.14 °C / °C
B	+350 to +1820 °C	0.01 °C	1 °C	0.14 °C / °C

\*Relative to simulated junction

Thermistor: (2.2 kΩ, 5 kΩ, 10 kΩ or User Type)

Range	Resolution	90 Day/1 Year (23 °C±5 °C)*	Temperature Coefficient / °C
-80 ° to 150 °C	0.001 °C	0.1 °C	0.003 °C / °C

Reading Rate (Readings/sec)	TCO/RTD/ Thermistor	Speed	Digits
		5/s	6 ½
		20/s	5 ½
		60/s	4 ½

[1] The actual measurement range and test lead error will be constrained by the adopted test lead. The test lead accuracy adder covers all errors of measurements and ITS-90 temperature change.

### Capacitance [1]

Range	24 Hour TCAL ± 1 °C	90 Day TCAL ± 5 °C	1 Year TCAL ± 5 °C	Temperature Coefficient/ °C
1.000 nF	2.00 + 2.00	2.00 + 2.00	2.00 + 2.00	0.05 + 0.01
10.00 nF	2.00 + 1.00	2.00 + 1.00	2.00 + 1.00	0.05 + 0.01
100.0 nF	2.00 + 0.40	2.00 + 0.40	2.00 + 0.40	0.05 + 0.01
1.000 µF	2.00 + 0.40	2.00 + 0.40	2.00 + 0.40	0.05 + 0.01
10.00 µF	2.00 + 0.40	2.00 + 0.40	2.00 + 0.40	0.05 + 0.01
100.0 µF	2.00 + 0.40	2.00 + 0.40	2.00 + 0.40	0.05 + 0.01

Accuracy Specifications: ± ( % of reading + % of range )

[1] Specifications are for film Capacitance inputs that are greater than 10% range.

## Capacitance

Measurement method: DC recharge & discharge.

Input protection: 500 Vpeak on all ranges.

---

The capacitor under test ( $C_x$ ) is charged using a constant current source. The time to charge  $C_x$  is recorded. The capacitor is then discharged using a known resistance and the discharge time is recorded. The value of the resistance depends on the capacitance range that is selected. The charge and discharge time is used to calculate the capacitance of  $C_x$  if the selected capacitance range is equal to or less than 10 nF. Only the charge time is used to calculate the capacitance of  $C_x$  if the selected capacitance range is equal to or greater than 100 nF.

As measuring capacitance with the DMM is effectively a DC measurement, the measured capacitance tends to be higher than what is measured by LCR meters.

For best measurement results, first perform a zeroing of the test leads when the cables are “open” to compensate for the test lead capacitance.

# Dimensions

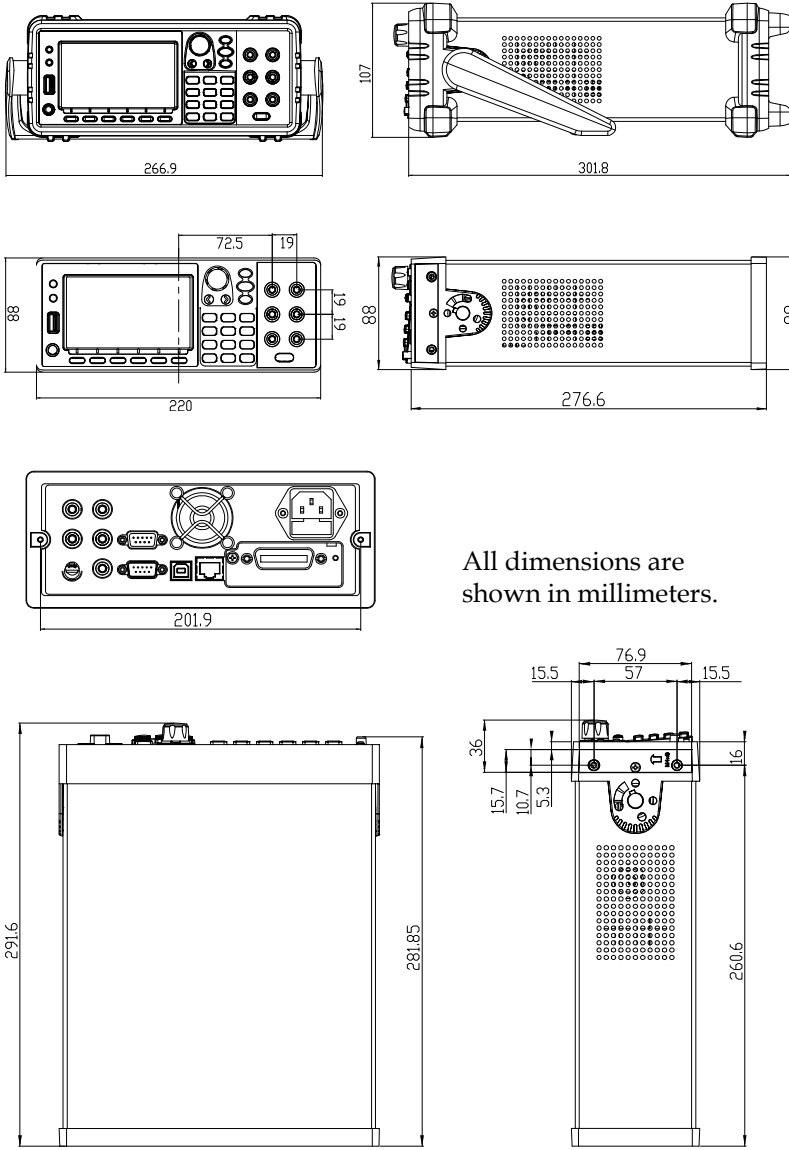

All dimensions are shown in millimeters.



# Declaration of Conformity

We Declare that the below mentioned product  
 Type of Product: **Digital Multimeter**  
 Model Number: **RSDM-9060 / RSDM-9061**  
 satisfies all the technical relations application to the product within the scope of council:  
**Directive:** 2014/30/EU; 2014/35/EU; 2011/65/EU; 2012/19/EU  
 The above product is in conformity with the following standards or other normative documents:

## © EMC

<b>EN 61326-1:</b>	Electrical equipment for measurement, control and laboratory use — EMC requirements (2013)	
<b>EN 61326-2-1:</b>		
<b>EN 61326-2-2:</b>		
Conducted & Radiated Emission EN 55011: 2016+A1:2017 Class A	Electrical Fast Transients EN 61000-4-4: 2012	
Current Harmonics EN 61000-3-2: 2014	Surge Immunity EN 61000-4-5: 2014	
Voltage Fluctuations EN 61000-3-3: 2013	Conducted Susceptibility EN 61000-4-6: 2014	
Electrostatic Discharge EN 61000-4-2: 2009	Power Frequency Magnetic Field EN 61000-4-8: 2010	
Radiated Immunity EN 61000-4-3: 2006+A1: 2008+A2: 2010	Voltage Dip/ Interruption EN 61000-4-11: 2004	

## © Safety

<b>Low Voltage Equipment Directive 2014/35/EU</b>	
Safety Requirements	EN 61010-1: 2010 / EN 61010-2-030: 2010

## **Africa**

RS Components SA  
P.O. Box 12182, Vorna Valley 1686  
20 Indianapolis Street, Kyalami Business Park  
Kyalami, Midrand, South Africa

## **Asia**

RS Components Ltd.  
Suite 1601, Level 16, Tower 1, Kowloon Commerce Centre,  
51 Kwai Cheong Road, Kwai Chung, Hong Kong

## **China**

RS Components Ltd.  
Suite 23 A-C, East Sea Business Centre Phase 2  
NO. 618 Yan'an Eastern Road, Shanghai, 200001, China

## **Europe**

RS Components Ltd.  
PO Box 99, Corby, Northants NN17 9RS  
United Kingdom

## **Japan**

RS Components Ltd.  
West Tower (12th Floor), Yokohama Business Park,  
134 Godocho, Hodogaya, Yokohama,  
Kanagawa 240-0005 Japan

## **North America**

Allied Electronics  
7151 Jack Newell Blvd. S. Fort Worth, Texas 76118  
U.S.A.

## **South America**

RS Componentes Electrónicos Limitada  
Av. Pdte. Eduardo Frei M. 6001-71, Centro Empresas El Cortijo  
Conchali, Santiago, Chile



## AUDITED

In compliance with industry standards



## INSPECTED

For guaranteed quality and performance



## TESTED

By leading engineers

