

# Metal Film Precision Resistors

## CSR Series

**multicomp** PRO

**RoHS  
Compliant**



### Features

- Excellent overall stability
- Tight tolerance down to  $\pm 0.1\%$
- Extremely low TCR down to  $\pm 10$  PPM/ $^{\circ}\text{C}$
- High power rating up to 1 Watts

### Applications

- Automotive
- Telecommunication
- Medical Equipment
- Measurement / Testing Equipment

### Construction

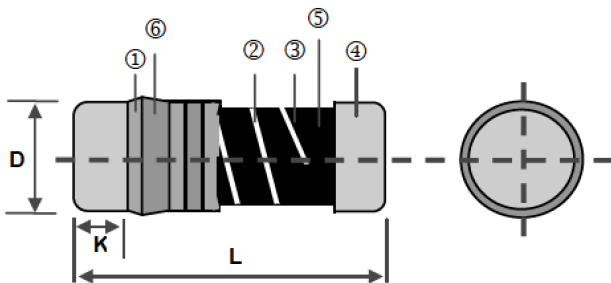

①	Insulation Coating	④	Electrode Cap (Fe, Cu, Sn)
②	Trimming Line	⑤	Resistor Layer
③	Ceramic Road	⑥	Marking

### Dimensions

Type	Case Style	L	$\Phi D$	K min.	Weight (g) (1,000pcs)	Packaging
						180mm (7")
MCFRBTNV MCFRFTDV	1405 [3614 Metric]	$3.50 \pm 0.2$	$1.40 \pm 0.15$	0.5	18.7	3,000EA
MCFRFTDU	2409 [6123 Metric]	$5.90 \pm 0.2$	$2.20 \pm 0.20$	0.5	80.9	2,000EA

Dimensions : Millimetres

### Derating Curve

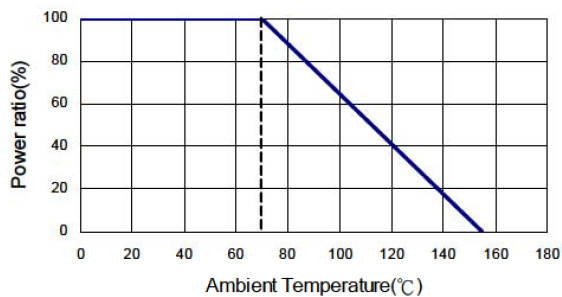

# Metal Film Precision Resistors

## CSR Series



### Standard Electrical Specifications

Item Type	Power Rating at 70°C	Operating Temp. Range	Max. Operating Voltage	Max. Overload Voltage	Resistance Range					TCR (PPM/°C)
					±0.1%	± 0.25%	± 0.5%	± 1%	± 5%	
MCFRBTN MCFRFTDV	1 / 4W	-55 ~ +155°C	200V	400V	49.9Ω - 20KΩ					± 10
					49.9Ω - 300KΩ					± 15
					10Ω - 1MΩ		10Ω - 4.7MΩ			± 25
					10Ω - 1MΩ	1Ω - 1MΩ	0.2Ω - 10MΩ			± 50
					-			0.1Ω - 10MΩ		± 100
	Jumper: 2A	-			0Ω (<15mΩ)	-				
MCFRFTDU	1 / 2W	-55 ~ +155°C	300V	500V	49.9Ω - 20KΩ					± 10
					49.9Ω - 300KΩ					± 15
					10Ω - 1MΩ		10Ω - 4.7MΩ			± 25
					10Ω - 1MΩ	1Ω - 1MΩ	0.2Ω - 10MΩ			± 50
					-			0.1Ω - 10MΩ		± 100
	Jumper: 4A	-			0Ω (<15mΩ)	-				

### High Power Rating Electrical Specifications

Item Type	Power Rating at 70°C	Operating Temp. Range	Max. Operating Voltage	Max. Overload Voltage	Resistance Range					TCR (PPM/°C)
					± 0.1%	± 0.25%	± 0.5%	± 1%	± 5%	
MCFRFTDU	1W	-55 ~ +155°C	350V	700V	49.9Ω - 100KΩ					± 15
					10Ω - 1MΩ					± 25
					10Ω - 1MΩ	1Ω - 1MΩ	0.2Ω - 10MΩ			± 50
					-			0.1Ω - 10MΩ		± 100

### Environmental Characteristics

Item	Requirement	Test Method
Temperature Coefficient of Resistance (T.C.R.)	As Spec	<b>JIS-C-5201-1 4.8</b> <b>IEC 60115-1 4.8</b> -55°C ~ +125°C, 25°C is the reference temperature
Short Time Overload	± (0.15% + 0.05Ω)	<b>JIS-C-5201-1 4.13</b> <b>IEC-60115-1 4.13</b> RCWV × 2.5 or Max. overload voltage for 5 seconds
Insulation Resistance	≥ 10G	<b>JIS-C-5201-1 4.6</b> <b>IEC-60115-1 4.6</b> Max.overload voltage for 1minute
Endurance	± (0.5% + 0.05Ω)	<b>JIS-C-5201-1 4.25</b> <b>IEC-60115-1 4.25.1</b> 70 ± 2°C, Max. working voltage for 1,000 hrs with 1.5 hrs "ON" and 0.5 hrs "OFF"
Damp Heat with Load	± (1.0% + 0.05Ω)	<b>JIS-C-5201-1 4.24</b> 40 ± 2°C, 90 ~ 95% R.H. Max. working voltage for 1,000 hrs with 1.5 hrs "ON" and 0.5 hrs "OFF"
Dry Heat	± (1.0% + 0.05Ω)	<b>JIS-C-5201-1 4.23</b> <b>IEC-60115-1 2.23.2</b> at +155°C for 1,000 hrs
Bending Strength	± (0.5% + 0.05Ω)	<b>JIS-C-5201-1 4.33</b> <b>IEC 60115-1 4.33</b> Bending once for 5 seconds with 2mm
Solderability	95% min.coverage	<b>JIS-C-5201-1 4.17</b> <b>IEC 60115-1 4.17</b> 245 ± 5°C for 3 seconds
Resistance to Soldering Heat	± (0.5% + 0.05Ω)	<b>JIS-C-5201-1 4.18</b> <b>IEC 60115-1 4.18</b> 260 ± 5°C for 10 seconds
Voltage Proof	No breakdown or flash-over	<b>JIS-C-5201-1 4.7</b> <b>IEC 60115-1 4.7</b> 1.42 times RCWV (RMS) for 1minute
Leaching	Individual leaching area ≤ 5% Total leaching area ≤ 10%	<b>JIS-C-5201-1 4.18</b> <b>IEC 60068-2-58 8.2.1</b> 260 ± 5°C for 30 seconds
Rapid Change of Temperature	± (0.5% + 0.05Ω)	<b>JIS-C-5201-1 4.18</b> <b>IEC 60115-1 4.18</b> -55°C ~ +155°C, 5 cycles

Storage Temperature : 25 ± 3°C; Humidity < 80%RH

### Soldering Condition

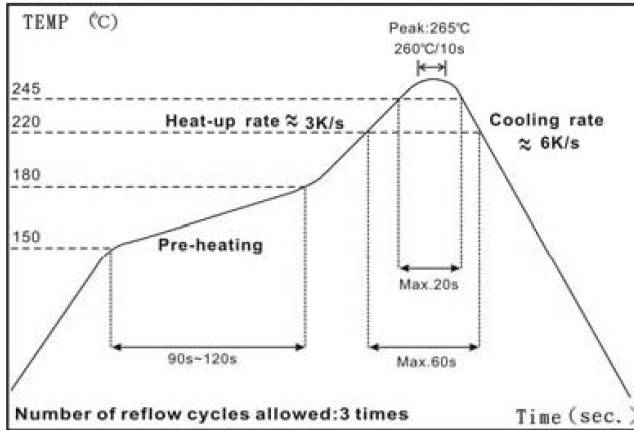

IR Reflow Soldering

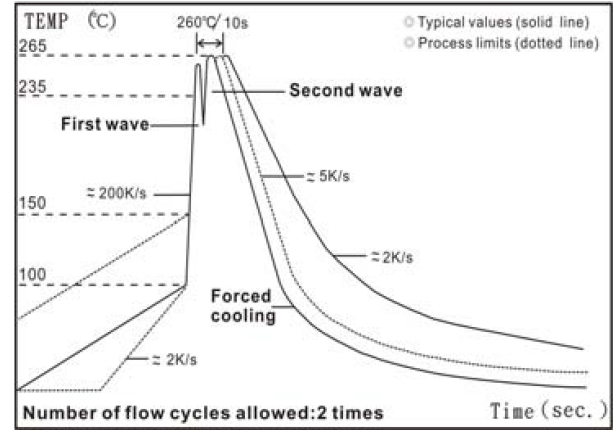

Wave Soldering (Flow Soldering)

- (1) Time of IR reflow soldering at maximum temperature point 260°C : 10s
- (2) Time of wave soldering at maximum temperature point 260°C : 10s
- (3) Time of soldering iron at maximum temperature point 410°C : 5s

### Packing

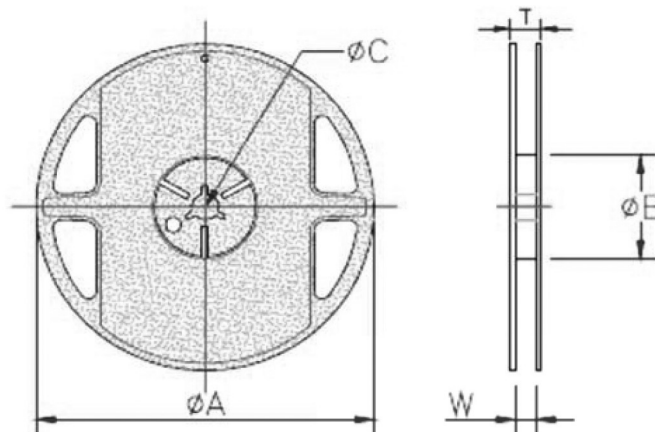

### Packing Quantity & Real Specifications

Type	ΦA	ΦB	ΦC	W	T	Emboss Plastic Tape (EA)
MCFRBTNV MCFRFTDV	178.5 ± 1.5	60 ± 1	13 ± 0.2	9 ± 0.5	12.5 ± 0.5	3,000
MCFRFTDU	178.5 ± 1.5	60 ± 1	13 ± 0.5	13 ± 0.5	15.5 ± 0.5	2,000

Dimensions: mm

# Metal Film Precision Resistors

## CSR Series



### Emboss Plastic Tape Specifications

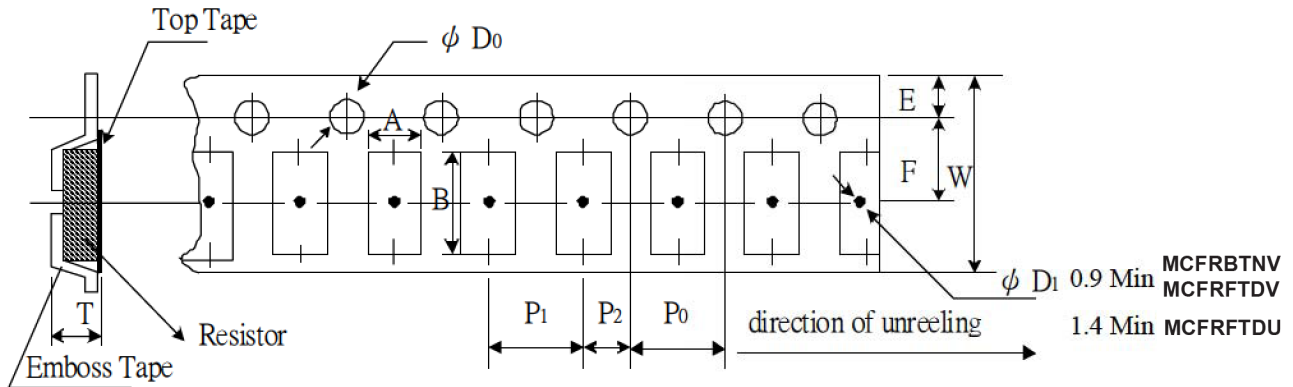

Type	A	8	w	E	F	P <sub>0</sub>	p <sub>1</sub>	p <sub>2</sub>	ΦD <sub>0</sub>	T
MCFRBTNV MCFRFTDV	1.6 ± 0.10	3.7 ± 0.1	8 ± 0.1	1.75 ± 0.1	3.5 ± 0.05	4 ± 0.1	4 ± 0.1	2 ± 0.05	1.5 + 0.1	1.87 ± 0.1
MCFRFTDU	2.4 ± 0.1	6.05 ± 0.1	12 ± 0.1	1.75 ± 0.1	5.5 ± 0.05	4 ± 0.1	4 ± 0.1	2 ± 0.05	1.5 + 0.1	2.8 ± 0.1

Dimensions: mm

### Pulse withstanding capacity

The single impulse graph is the result of 50 impulses of rectangular shape applied at one-minute intervals. The limit of acceptance was a shift in resistance of less than 1% from the initial value. The power applied was subject to the restrictions of the maximum permissible impulse voltage graph shown.

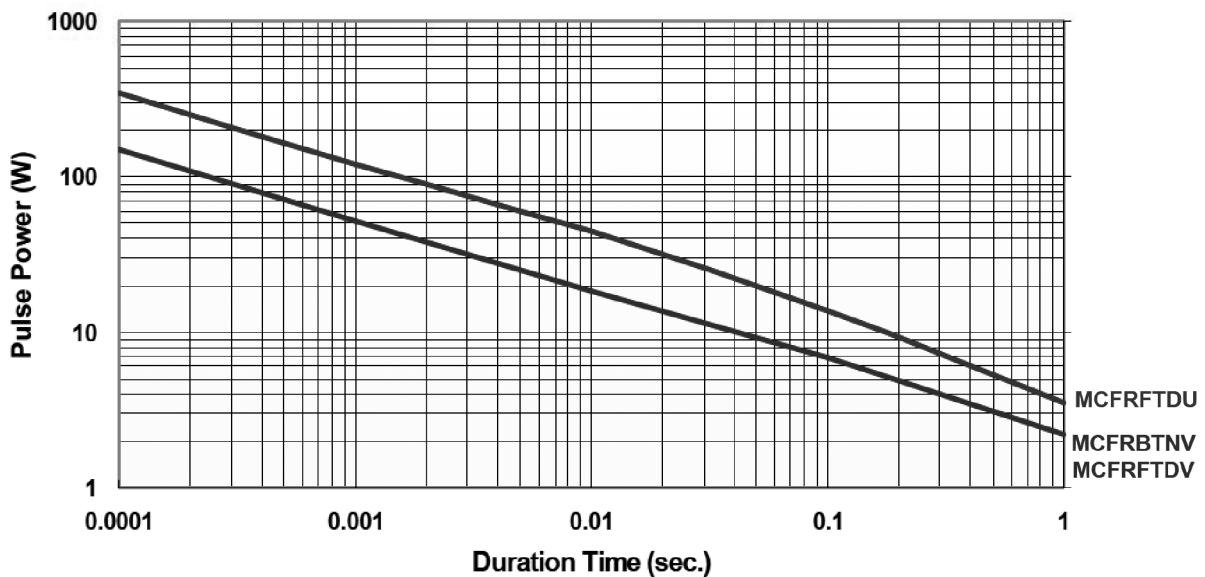

### Continuous Pulse

The continuous load graph was obtained by applying repetitive rectangular pulses where the pulse period was adjusted so that the average power dissipated in the resistor was equal to its rated power at 70°C. Again the limit of acceptance was a shift in resistance of less than 1% from the initial value.

**CSR Series Continuous Pulse (100Ω)**

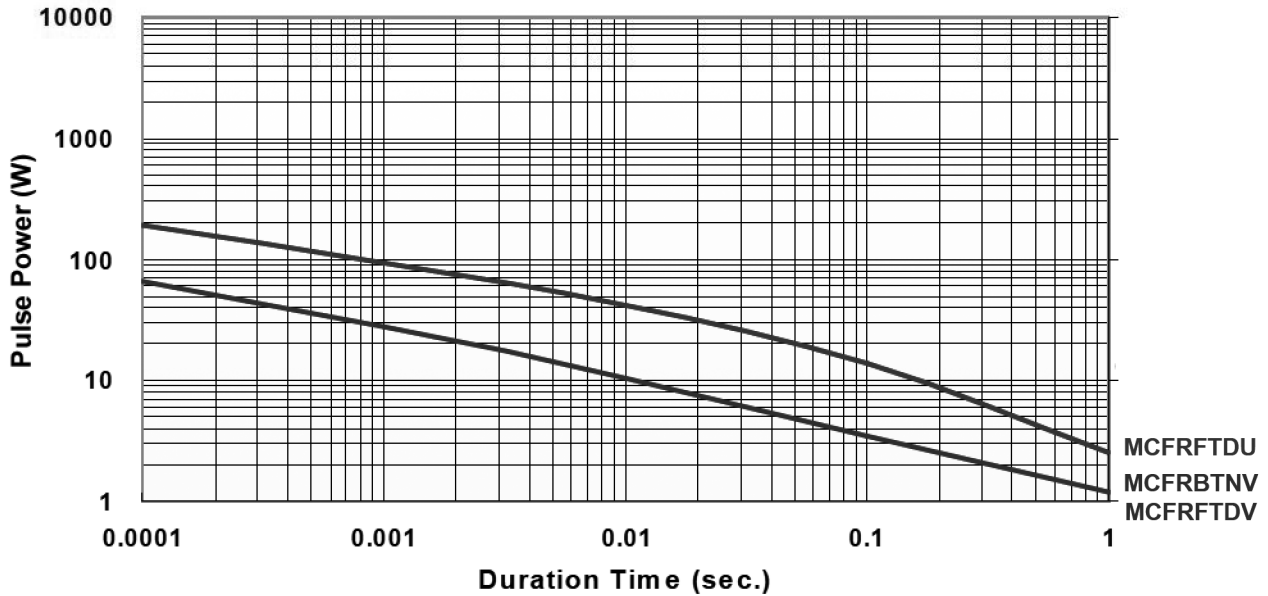

**CSR Series Pulse (100Ω)**

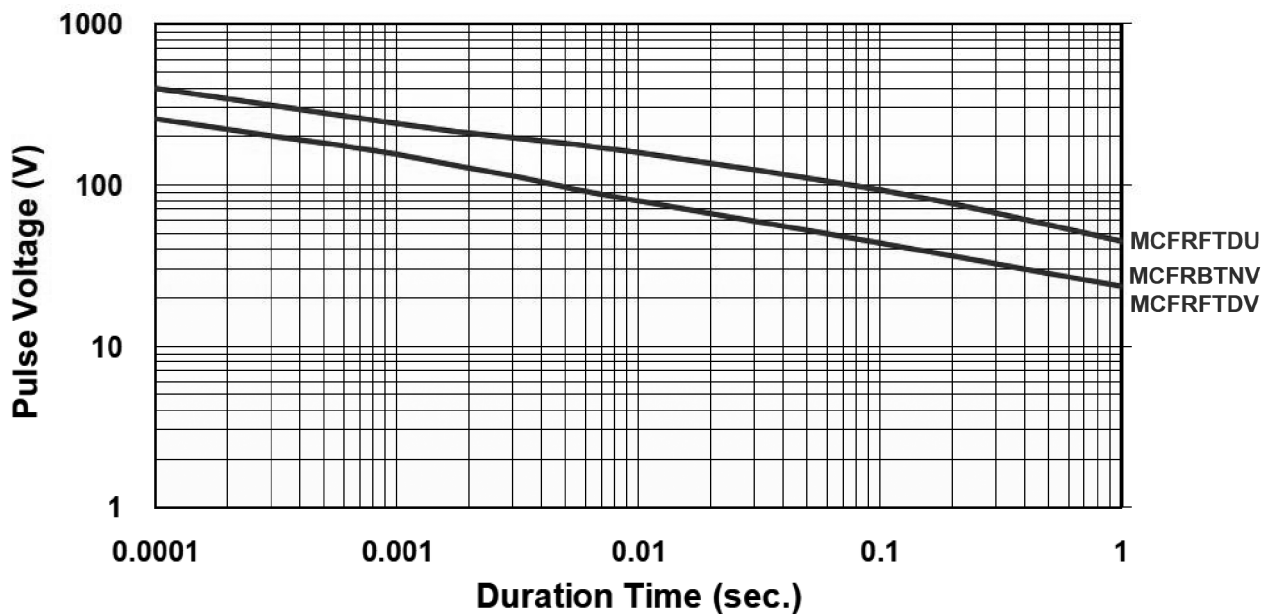

### Frequency behavior

Resistors are designed to function according to ohmic laws. This is basically true of resistors for frequencies up to 100KHz. At higher frequencies, there is an additional contribution to the impedance by an ideal resistor switched in series with a coil and both switched parallel to a capacitor. The values of the capacitance and inductance are mainly determined by the dimensions of the terminations and the conductive path length.

The environment surrounding components has a large influence on the behavior of the component on the printed-circuit board.

**Frequency vs. Impedance**  
CSR Series (MCFRBTNV / MCFRFTDV)

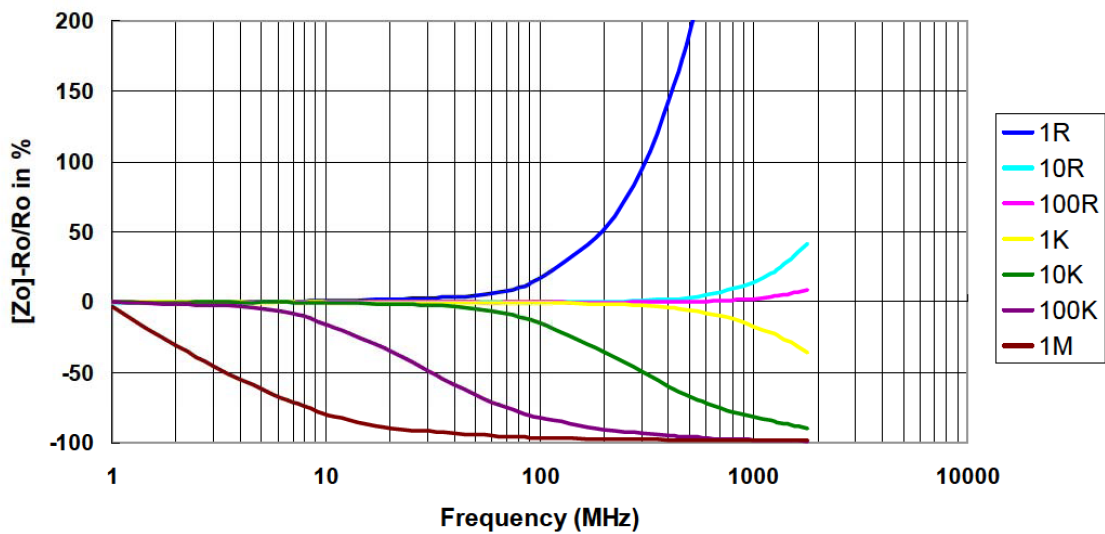

**Frequency vs. Phase Angle**  
CSR Series (MCFRBTNV / MCFRFTDV)

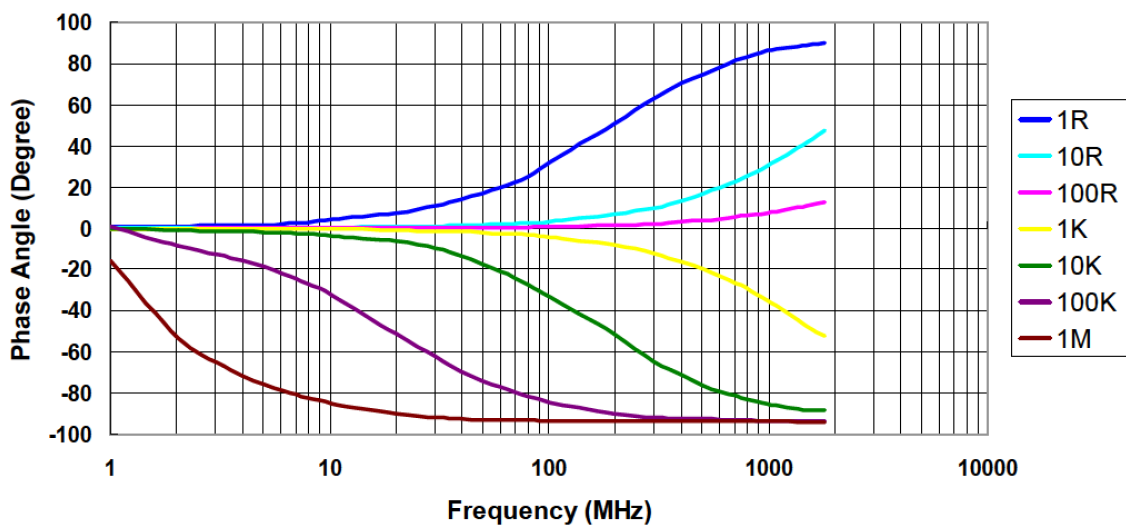

Frequency vs. Impedance  
CSR Series (MCFRFTDU)

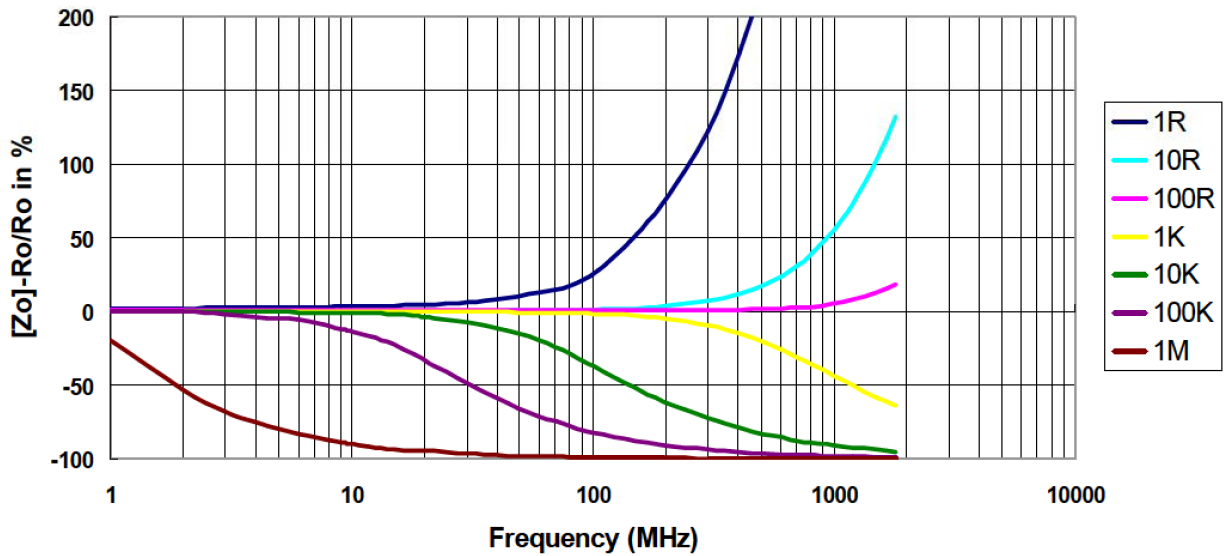

Frequency vs. Phase Angle  
CSR Series (MCFRFTDU)

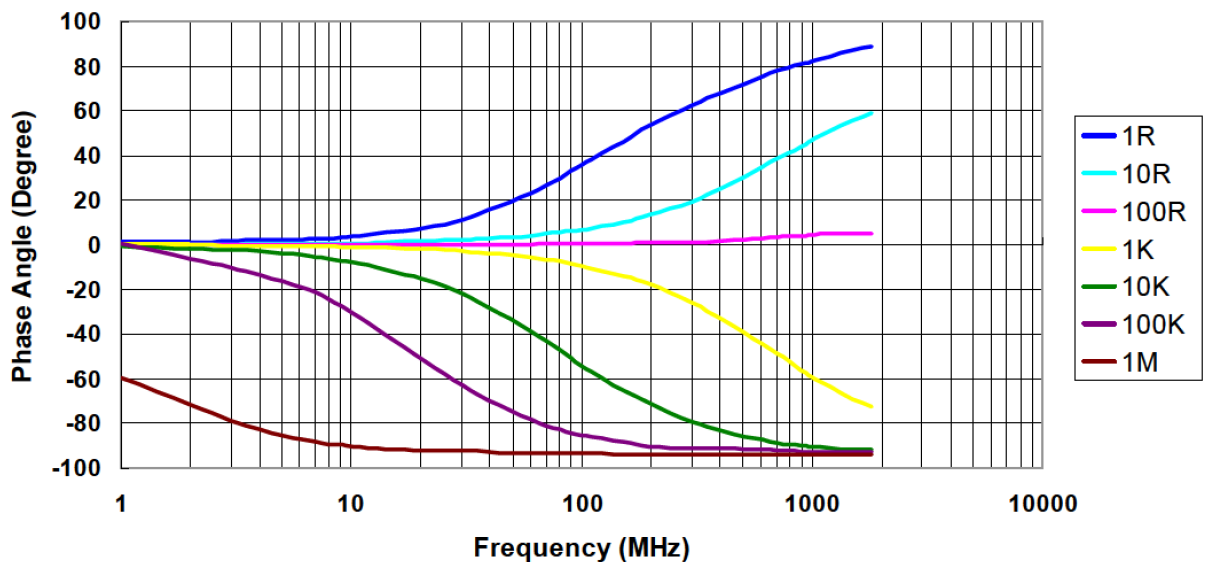



### Lightning Surge

Resistors are tested in accordance with IEC 60 115-1 using both 1.2 / 50µs and 10 / 700µs pulse shapes. The limit of acceptance is a shift in resistance of less than 0.5% from the initial value.

#### 1.2 / 50µs Lightning Surge

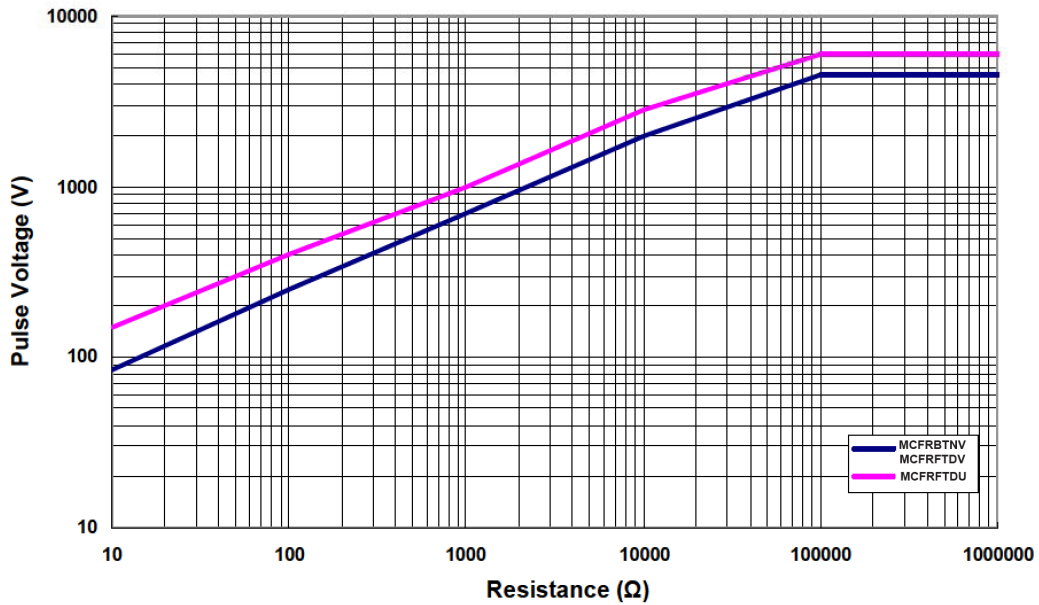

#### 10 / 700µs Lightning Surge

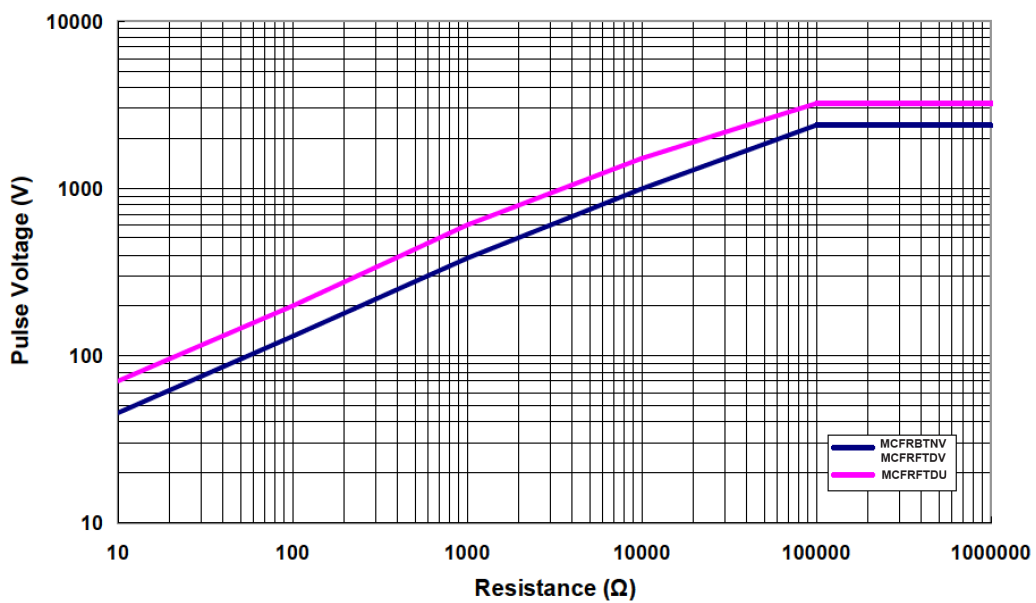

# Metal Film Precision Resistors

## CSR Series



### Marking and Resistance Tolerance



1st digit    2nd digit    Multiplier

±5%	E-24	1.0	1.1	1.2	1.3	1.5	1.6	1.8	2.0	2.2	2.4	2.7	3.0	3.3	3.6	3.9	4.3	4.7	5.1	5.6	6.2	6.8	7.5	8.2	9.1
-----	------	-----	-----	-----	-----	-----	-----	-----	-----	-----	-----	-----	-----	-----	-----	-----	-----	-----	-----	-----	-----	-----	-----	-----	-----

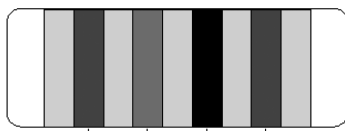

1st digit    2nd digit    3rd digit    Multiplier

±1%	E-96	1.00	1.02	1.05	1.07	1.10	1.13	1.15	1.18	1.21	1.24	1.27	1.30	1.33	1.37	1.40	1.43	1.47	1.50	1.54	1.58	1.62	1.65	1.69	1.74
		1.78	1.82	1.87	1.91	1.96	2.00	2.05	2.10	2.15	2.21	2.26	2.32	2.37	2.43	2.49	2.55	2.61	2.67	2.74	2.80	2.87	2.94	3.01	3.09
		3.16	3.24	3.32	3.40	3.48	3.57	3.65	3.74	3.83	3.92	4.02	4.12	4.22	4.32	4.42	4.53	4.64	4.75	4.87	4.99	5.11	5.23	5.36	5.49
		5.62	5.76	5.90	6.04	6.19	6.34	6.49	6.65	6.81	6.98	7.15	7.32	7.50	7.68	7.87	8.06	8.25	8.45	8.66	8.87	9.09	9.31	9.53	9.76
±0.5% ±0.25% ±0.1%	E-192	10.0	10.1	10.2	10.4	10.5	10.6	10.7	10.9	11.0	11.1	11.3	11.4	11.5	11.7	11.8	12.0	12.1	12.3	12.4	12.6	12.7	12.9	13.0	13.2
		13.3	13.5	13.7	13.8	14.0	14.2	14.3	14.5	14.7	14.9	15.0	15.2	15.4	15.6	15.8	16.0	16.2	16.4	16.5	16.7	16.9	17.2	17.4	17.6
		17.8	18.0	18.2	18.4	18.7	18.9	19.1	19.3	19.6	19.8	20.0	20.3	20.5	20.8	21.0	21.3	21.5	21.8	22.1	22.3	22.6	22.9	23.2	23.4
		23.7	24.0	24.3	24.6	24.9	25.2	25.5	25.8	26.1	26.4	26.7	27.1	27.4	27.7	28.0	28.4	28.7	29.1	29.4	29.8	30.1	30.5	30.9	31.2
		31.6	32.0	32.4	32.8	33.2	33.6	34.0	34.4	34.8	35.2	35.7	36.1	36.5	37.0	37.4	37.9	38.3	38.8	39.2	39.7	40.2	40.7	41.2	41.7
		42.2	42.7	43.2	43.7	44.2	44.8	45.3	45.9	46.4	47.0	47.5	48.1	48.7	49.3	49.9	50.5	51.1	51.7	52.3	53.0	53.6	54.2	54.9	55.6
		56.2	56.9	57.6	58.3	59.0	59.7	60.4	61.2	61.9	62.6	63.4	64.2	64.9	65.7	66.5	67.3	68.1	69.0	69.8	70.6	71.5	72.3	73.2	74.1
		75.0	75.9	76.8	77.7	78.7	79.6	80.6	81.6	82.5	83.5	84.5	85.6	86.6	87.6	88.7	89.8	90.9	92.0	93.1	94.2	95.3	96.5	97.6	98.8

Colour	Digit	Multiplier
Silver	-	10 <sup>-2</sup>
Gold	-	10 <sup>-1</sup>
Black	0	10 <sup>0</sup>
Brown	1	10 <sup>1</sup>
Red	2	10 <sup>2</sup>
Orange	3	10 <sup>3</sup>
Yellow	4	10 <sup>4</sup>
Green	5	10 <sup>5</sup>
Blue	6	10 <sup>6</sup>
Violet	7	10 <sup>7</sup>
Grey	8	10 <sup>8</sup>
White	9	10 <sup>9</sup>

Resistance more than two significant figures(<1R) or more than three significant figures(>1R) will not provide colour code.

Newark.com/multicomp-pro  
 Farnell.com/multicomp-pro  
 sg.element14.com/b/multicomp-pro



# Metal Film Precision Resistors

## CSR Series

**multicomp** PRO

### Part Number Table

Description	Part Number
Resistor, MELF, 0R0, 5%, 0.25W	MCFRJT-VR0R0
Resistor, MELF, 0R0, 1%, 0.25W	MCFRFT-VR0R0
Resistor, MELF, 51R, 0.1%, 0.25W	MCFRBTN0510
Resistor, MELF, 56R, 0.1%, 0.25W	MCFRBTN0560
Resistor, MELF, 62R, 0.1%, 0.25W	MCFRBTN0620
Resistor, MELF, 68R, 0.1%, 0.25W	MCFRBTN0680
Resistor, MELF, 75R, 0.1%, 0.25W	MCFRBTN0750
Resistor, MELF, 82R, 0.1%, 0.25W	MCFRBTN0820
Resistor, MELF, 91R, 0.1%, 0.25W	MCFRBTN0910
Resistor, MELF, 100R, 0.1%, 0.25W	MCFRBTN1000
Resistor, MELF, 110R, 0.1%, 0.25W	MCFRBTN1100
Resistor, MELF, 120R, 0.1%, 0.25W	MCFRBTN1200
Resistor, MELF, 130R, 0.1%, 0.25W	MCFRBTN1300
Resistor, MELF, 150R, 0.1%, 0.25W	MCFRBTN1500
Resistor, MELF, 160R, 0.1%, 0.25W	MCFRBTN1600
Resistor, MELF, 180R, 0.1%, 0.25W	MCFRBTN1800
Resistor, MELF, 200R, 0.1%, 0.25W	MCFRBTN2000
Resistor, MELF, 220R, 0.1%, 0.25W	MCFRBTN2200
Resistor, MELF, 240R, 0.1%, 0.25W	MCFRBTN2400
Resistor, MELF, 270R, 0.1%, 0.25W	MCFRBTN2700
Resistor, MELF, 300R, 0.1%, 0.25W	MCFRBTN3000
Resistor, MELF, 330R, 0.1%, 0.25W	MCFRBTN3300
Resistor, MELF, 360R, 0.1%, 0.25W	MCFRBTN3600
Resistor, MELF, 390R, 0.1%, 0.25W	MCFRBTN3900
Resistor, MELF, 430R, 0.1%, 0.25W	MCFRBTN4300
Resistor, MELF, 470R, 0.1%, 0.25W	MCFRBTN4700
Resistor, MELF, 510R, 0.1%, 0.25W	MCFRBTN5100
Resistor, MELF, 560R, 0.1%, 0.25W	MCFRBTN5600
Resistor, MELF, 620R, 0.1%, 0.25W	MCFRBTN6200
Resistor, MELF, 680R, 0.1%, 0.25W	MCFRBTN6800
Resistor, MELF, 750R, 0.1%, 0.25W	MCFRBTN7500
Resistor, MELF, 820R, 0.1%, 0.25W	MCFRBTN8200
Resistor, MELF, 910R, 0.1%, 0.25W	MCFRBTN9100
Resistor, MELF, 1K, 0.1%, 0.25W	MCFRBTN1001
Resistor, MELF, 1K1, 0.1%, 0.25W	MCFRBTN1101
Resistor, MELF, 1K2, 0.1%, 0.25W	MCFRBTN1201
Resistor, MELF, 1K3, 0.1%, 0.25W	MCFRBTN1301

Description	Part Number
Resistor, MELF, 1K5, 0.1%, 0.25W	MCFRBTN1501
Resistor, MELF, 1K6, 0.1%, 0.25W	MCFRBTN1601
Resistor, MELF, 1K8, 0.1%, 0.25W	MCFRBTN1801
Resistor, MELF, 2K, 0.1%, 0.25W	MCFRBTN2001
Resistor, MELF, 2K2, 0.1%, 0.25W	MCFRBTN2201
Resistor, MELF, 2K4, 0.1%, 0.25W	MCFRBTN2401
Resistor, MELF, 2K7, 0.1%, 0.25W	MCFRBTN2701
Resistor, MELF, 3K, 0.1%, 0.25W	MCFRBTN3001
Resistor, MELF, 3K3, 0.1%, 0.25W	MCFRBTN3301
Resistor, MELF, 3K6, 0.1%, 0.25W	MCFRBTN3601
Resistor, MELF, 3K9, 0.1%, 0.25W	MCFRBTN3901
Resistor, MELF, 4K3, 0.1%, 0.25W	MCFRBTN4301
Resistor, MELF, 4K7, 0.1%, 0.25W	MCFRBTN4701
Resistor, MELF, 5K1, 0.1%, 0.25W	MCFRBTN5101
Resistor, MELF, 5K6, 0.1%, 0.25W	MCFRBTN5601
Resistor, MELF, 6K2, 0.1%, 0.25W	MCFRBTN6201
Resistor, MELF, 6K8, 0.1%, 0.25W	MCFRBTN6801
Resistor, MELF, 7K5, 0.1%, 0.25W	MCFRBTN7501
Resistor, MELF, 8K2, 0.1%, 0.25W	MCFRBTN8201
Resistor, MELF, 9K1, 0.1%, 0.25W	MCFRBTN9101
Resistor, MELF, 10K, 0.1%, 0.25W	MCFRBTN1002
Resistor, MELF, 11K, 0.1%, 0.25W	MCFRBTN1102
Resistor, MELF, 12K, 0.1%, 0.25W	MCFRBTN1202
Resistor, MELF, 13K, 0.1%, 0.25W	MCFRBTN1302
Resistor, MELF, 15K, 0.1%, 0.25W	MCFRBTN1502
Resistor, MELF, 16K, 0.1%, 0.25W	MCFRBTN1602
Resistor, MELF, 18K, 0.1%, 0.25W	MCFRBTN1802
Resistor, MELF, 20K, 0.1%, 0.25W	MCFRBTN2002
Resistor, MELF, 22K, 0.1%, 0.25W	MCFRBTN2202
Resistor, MELF, 24K, 0.1%, 0.25W	MCFRBTN2402
Resistor, MELF, 27K, 0.1%, 0.25W	MCFRBTN2702
Resistor, MELF, 30K, 0.1%, 0.25W	MCFRBTN3002
Resistor, MELF, 33K, 0.1%, 0.25W	MCFRBTN3302
Resistor, MELF, 36K, 0.1%, 0.25W	MCFRBTN3602
Resistor, MELF, 39K, 0.1%, 0.25W	MCFRBTN3902
Resistor, MELF, 43K, 0.1%, 0.25W	MCFRBTN4302
Resistor, MELF, 47K, 0.1%, 0.25W	MCFRBTN4702

Newark.com/multicomp-pro  
 Farnell.com/multicomp-pro  
 sg.element14.com/b/multicomp-pro

**multicomp** PRO

# Metal Film Precision Resistors

## CSR Series

**multicomp** PRO

Description	Part Number
Resistor, MELF, 51K, 0.1%, 0.25W	MCFRBTN5102
Resistor, MELF, 56K, 0.1%, 0.25W	MCFRBTN5602
Resistor, MELF, 62K, 0.1%, 0.25W	MCFRBTN6202
Resistor, MELF, 68K, 0.1%, 0.25W	MCFRBTN6802
Resistor, MELF, 75K, 0.1%, 0.25W	MCFRBTN7502
Resistor, MELF, 82K, 0.1%, 0.25W	MCFRBTN8202
Resistor, MELF, 91K, 0.1%, 0.25W	MCFRBTN9102
Resistor, MELF, 100K, 0.1%, 0.25W	MCFRBTN1003
Resistor, MELF, 110K, 0.1%, 0.25W	MCFRBTN1103
Resistor, MELF, 120K, 0.1%, 0.25W	MCFRBTN1203
Resistor, MELF, 130K, 0.1%, 0.25W	MCFRBTN1303
Resistor, MELF, 150K, 0.1%, 0.25W	MCFRBTN1503
Resistor, MELF, 160K, 0.1%, 0.25W	MCFRBTN1603
Resistor, MELF, 180K, 0.1%, 0.25W	MCFRBTN1803
Resistor, MELF, 200K, 0.1%, 0.25W	MCFRBTN2003
Resistor, MELF, 220K, 0.1%, 0.25W	MCFRBTN2203
Resistor, MELF, 1R, 1%, 0.25W	MCFRFTDV1R00
Resistor, MELF, 1R2, 1%, 0.25W	MCFRFTDV1R20
Resistor, MELF, 1R5, 1%, 0.25W	MCFRFTDV1R50
Resistor, MELF, 1R8, 1%, 0.25W	MCFRFTDV1R80
Resistor, MELF, 2R2, 1%, 0.25W	MCFRFTDV2R20
Resistor, MELF, 2R7, 1%, 0.25W	MCFRFTDV2R70
Resistor, MELF, 3R3, 1%, 0.25W	MCFRFTDV3R30
Resistor, MELF, 3R9, 1%, 0.25W	MCFRFTDV3R90
Resistor, MELF, 4R7, 1%, 0.25W	MCFRFTDV4R70
Resistor, MELF, 5R6, 1%, 0.25W	MCFRFTDV5R60
Resistor, MELF, 6R8, 1%, 0.25W	MCFRFTDV6R80
Resistor, MELF, 8R2, 1%, 0.25W	MCFRFTDV8R20
Resistor, MELF, 10R, 1%, 0.25W	MCFRFTDV0100
Resistor, MELF, 12R, 1%, 0.25W	MCFRFTDV0120
Resistor, MELF, 15R, 1%, 0.25W	MCFRFTDV0150
Resistor, MELF, 18R, 1%, 0.25W	MCFRFTDV0180
Resistor, MELF, 22R, 1%, 0.25W	MCFRFTDV0220
Resistor, MELF, 27R, 1%, 0.25W	MCFRFTDV0270
Resistor, MELF, 33R, 1%, 0.25W	MCFRFTDV0330
Resistor, MELF, 39R, 1%, 0.25W	MCFRFTDV0390
Resistor, MELF, 47R, 1%, 0.25W	MCFRFTDV0470

Description	Part Number
Resistor, MELF, 56R, 1%, 0.25W	MCFRFTDV0560
Resistor, MELF, 68R, 1%, 0.25W	MCFRFTDV0680
Resistor, MELF, 82R, 1%, 0.25W	MCFRFTDV0820
Resistor, MELF, 100R, 1%, 0.25W	MCFRFTDV1000
Resistor, MELF, 120R, 1%, 0.25W	MCFRFTDV1200
Resistor, MELF, 150R, 1%, 0.25W	MCFRFTDV1500
Resistor, MELF, 180R, 1%, 0.25W	MCFRFTDV1800
Resistor, MELF, 220R, 1%, 0.25W	MCFRFTDV2200
Resistor, MELF, 270R, 1%, 0.25W	MCFRFTDV2700
Resistor, MELF, 330R, 1%, 0.25W	MCFRFTDV3300
Resistor, MELF, 390R, 1%, 0.25W	MCFRFTDV3900
Resistor, MELF, 470R, 1%, 0.25W	MCFRFTDV4700
Resistor, MELF, 560R, 1%, 0.25W	MCFRFTDV5600
Resistor, MELF, 680R, 1%, 0.25W	MCFRFTDV6800
Resistor, MELF, 820R, 1%, 0.25W	MCFRFTDV8200
Resistor, MELF, 1K, 1%, 0.25W	MCFRFTDV1001
Resistor, MELF, 1K2, 1%, 0.25W	MCFRFTDV1201
Resistor, MELF, 1K5, 1%, 0.25W	MCFRFTDV1501
Resistor, MELF, 1K8, 1%, 0.25W	MCFRFTDV1801
Resistor, MELF, 2K2, 1%, 0.25W	MCFRFTDV2201
Resistor, MELF, 2K7, 1%, 0.25W	MCFRFTDV2701
Resistor, MELF, 3K3, 1%, 0.25W	MCFRFTDV3301
Resistor, MELF, 3K9, 1%, 0.25W	MCFRFTDV3901
Resistor, MELF, 4K7, 1%, 0.25W	MCFRFTDV4701
Resistor, MELF, 5K6, 1%, 0.25W	MCFRFTDV5601
Resistor, MELF, 6K8, 1%, 0.25W	MCFRFTDV6801
Resistor, MELF, 8K2, 1%, 0.25W	MCFRFTDV8201
Resistor, MELF, 10K, 1%, 0.25W	MCFRFTDV1002
Resistor, MELF, 12K, 1%, 0.25W	MCFRFTDV1202
Resistor, MELF, 15K, 1%, 0.25W	MCFRFTDV1502
Resistor, MELF, 18K, 1%, 0.25W	MCFRFTDV1802
Resistor, MELF, 22K, 1%, 0.25W	MCFRFTDV2202
Resistor, MELF, 27K, 1%, 0.25W	MCFRFTDV2702
Resistor, MELF, 33K, 1%, 0.25W	MCFRFTDV3302
Resistor, MELF, 39K, 1%, 0.25W	MCFRFTDV3902
Resistor, MELF, 47K, 1%, 0.25W	MCFRFTDV4702
Resistor, MELF, 56K, 1%, 0.25W	MCFRFTDV5602

Newark.com/multicomp-pro  
 Farnell.com/multicomp-pro  
 sg.element14.com/b/multicomp-pro

**multicomp** PRO

# Metal Film Precision Resistors

## CSR Series

**multicomp** PRO

Description	Part Number
Resistor, MELF, 68K, 1%, 0.25W	MCFRFTDV6802
Resistor, MELF, 82K, 1%, 0.25W	MCFRFTDV8202
Resistor, MELF, 100K, 1%, 0.25W	MCFRFTDV1003
Resistor, MELF, 120K, 1%, 0.25W	MCFRFTDV1203
Resistor, MELF, 150K, 1%, 0.25W	MCFRFTDV1503
Resistor, MELF, 180K, 1%, 0.25W	MCFRFTDV1803
Resistor, MELF, 220K, 1%, 0.25W	MCFRFTDV2203
Resistor, MELF, 270K, 1%, 0.25W	MCFRFTDV2703
Resistor, MELF, 330K, 1%, 0.25W	MCFRFTDV3303
Resistor, MELF, 390K, 1%, 0.25W	MCFRFTDV3903
Resistor, MELF, 470K, 1%, 0.25W	MCFRFTDV4703
Resistor, MELF, 560K, 1%, 0.25W	MCFRFTDV5603
Resistor, MELF, 680K, 1%, 0.25W	MCFRFTDV6803
Resistor, MELF, 820K, 1%, 0.25W	MCFRFTDV8203
Resistor, MELF, 1M, 1%, 0.25W	MCFRFTDV1004
Resistor, MELF, 1M2, 1%, 0.25W	MCFRFTDV1204
Resistor, MELF, 1M5, 1%, 0.25W	MCFRFTDV1504
Resistor, MELF, 1M8, 1%, 0.25W	MCFRFTDV1804
Resistor, MELF, 2M2, 1%, 0.25W	MCFRFTDV2204
Resistor, MELF, 2M7, 1%, 0.25W	MCFRFTDV2704
Resistor, MELF, 3M3, 1%, 0.25W	MCFRFTDV3304
Resistor, MELF, 3M9, 1%, 0.25W	MCFRFTDV3904
Resistor, MELF, 4M7, 1%, 0.25W	MCFRFTDV4704
Resistor, MELF, 0R0, 0.5W	MCFRFT-UR0R0
Resistor, MELF, 1R, 1%, 0.5W	MCFRFTDU1R00
Resistor, MELF, 1R2, 1%, 0.5W	MCFRFTDU1R20
Resistor, MELF, 1R5, 1%, 0.5W	MCFRFTDU1R50
Resistor, MELF, 1R8, 1%, 0.5W	MCFRFTDU1R80
Resistor, MELF, 2R2, 1%, 0.5W	MCFRFTDU2R20
Resistor, MELF, 2R7, 1%, 0.5W	MCFRFTDU2R70
Resistor, MELF, 3R3, 1%, 0.5W	MCFRFTDU3R30
Resistor, MELF, 3R9, 1%, 0.5W	MCFRFTDU3R90
Resistor, MELF, 4R7, 1%, 0.5W	MCFRFTDU4R70
Resistor, MELF, 6R8, 1%, 0.5W	MCFRFTDU6R80
Resistor, MELF, 8R2, 1%, 0.5W	MCFRFTDU8R20
Resistor, MELF, 10R, 1%, 0.5W	MCFRFTDU0100

Description	Part Number
Resistor, MELF, 12R, 1%, 0.5W	MCFRFTDU0120
Resistor, MELF, 15R, 1%, 0.5W	MCFRFTDU0150
Resistor, MELF, 18R, 1%, 0.5W	MCFRFTDU0180
Resistor, MELF, 33R, 1%, 0.5W	MCFRFTDU0330
Resistor, MELF, 39R, 1%, 0.5W	MCFRFTDU0390
Resistor, MELF, 47R, 1%, 0.5W	MCFRFTDU0470
Resistor, MELF, 56R, 1%, 0.5W	MCFRFTDU0560
Resistor, MELF, 68R, 1%, 0.5W	MCFRFTDU0680
Resistor, MELF, 82R, 1%, 0.5W	MCFRFTDU0820
Resistor, MELF, 100R, 1%, 0.5W	MCFRFTDU1000
Resistor, MELF, 120R, 1%, 0.5W	MCFRFTDU1200
Resistor, MELF, 150R, 1%, 0.5W	MCFRFTDU1500
Resistor, MELF, 180R, 1%, 0.5W	MCFRFTDU1800
Resistor, MELF, 220R, 1%, 0.5W	MCFRFTDU2200
Resistor, MELF, 270R, 1%, 0.5W	MCFRFTDU2700
Resistor, MELF, 330R, 1%, 0.5W	MCFRFTDU3300
Resistor, MELF, 390R, 1%, 0.5W	MCFRFTDU3900
Resistor, MELF, 470R, 1%, 0.5W	MCFRFTDU4700
Resistor, MELF, 560R, 1%, 0.5W	MCFRFTDU5600
Resistor, MELF, 680R, 1%, 0.5W	MCFRFTDU6800
Resistor, MELF, 820R, 1%, 0.5W	MCFRFTDU8200
Resistor, MELF, 1K, 1%, 0.5W	MCFRFTDU1001
Resistor, MELF, 1K2, 1%, 0.5W	MCFRFTDU1201
Resistor, MELF, 1K5, 1%, 0.5W	MCFRFTDU1501
Resistor, MELF, 1K8, 1%, 0.5W	MCFRFTDU1801
Resistor, MELF, 2K2, 1%, 0.5W	MCFRFTDU2201
Resistor, MELF, 2K7, 1%, 0.5W	MCFRFTDU2701
Resistor, MELF, 3K3, 1%, 0.5W	MCFRFTDU3301
Resistor, MELF, 3K9, 1%, 0.5W	MCFRFTDU3901
Resistor, MELF, 4K7, 1%, 0.5W	MCFRFTDU4701
Resistor, MELF, 5K6, 1%, 0.5W	MCFRFTDU5601
Resistor, MELF, 6K8, 1%, 0.5W	MCFRFTDU6801
Resistor, MELF, 8K2, 1%, 0.5W	MCFRFTDU8201
Resistor, MELF, 10K, 1%, 0.5W	MCFRFTDU1002
Resistor, MELF, 12K, 1%, 0.5W	MCFRFTDU1202
Resistor, MELF, 15K, 1%, 0.5W	MCFRFTDU1502

Newark.com/multicomp-pro  
 Farnell.com/multicomp-pro  
 sg.element14.com/b/multicomp-pro

**multicomp** PRO

# Metal Film Precision Resistors

## CSR Series



Description	Part Number
Resistor, MELF, 18K, 1%, 0.5W	MCFRFTDU1802
Resistor, MELF, 22K, 1%, 0.5W	MCFRFTDU2202
Resistor, MELF, 27K, 1%, 0.5W	MCFRFTDU2702
Resistor, MELF, 33K, 1%, 0.5W	MCFRFTDU3302
Resistor, MELF, 39K, 1%, 0.5W	MCFRFTDU3902
Resistor, MELF, 47K, 1%, 0.5W	MCFRFTDU4702
Resistor, MELF, 56K, 1%, 0.5W	MCFRFTDU5602
Resistor, MELF, 68K, 1%, 0.5W	MCFRFTDU6802
Resistor, MELF, 82K, 1%, 0.5W	MCFRFTDU8202
Resistor, MELF, 100K, 1%, 0.5W	MCFRFTDU1003
Resistor, MELF, 120K, 1%, 0.5W	MCFRFTDU1203
Resistor, MELF, 150K, 1%, 0.5W	MCFRFTDU1503
Resistor, MELF, 180K, 1%, 0.5W	MCFRFTDU1803
Resistor, MELF, 220K, 1%, 0.5W	MCFRFTDU2203
Resistor, MELF, 270K, 1%, 0.5W	MCFRFTDU2703
Resistor, MELF, 330K, 1%, 0.5W	MCFRFTDU3303

Description	Part Number
Resistor, MELF, 390K, 1%, 0.5W	MCFRFTDU3903
Resistor, MELF, 470K, 1%, 0.5W	MCFRFTDU4703
Resistor, MELF, 560K, 1%, 0.5W	MCFRFTDU5603
Resistor, MELF, 680K, 1%, 0.5W	MCFRFTDU6803
Resistor, MELF, 820K, 1%, 0.5W	MCFRFTDU8203
Resistor, MELF, 1M, 1%, 0.5W	MCFRFTDU1004
Resistor, MELF, 1M2, 1%, 0.5W	MCFRFTDU1204
Resistor, MELF, 1M5, 1%, 0.5W	MCFRFTDU1504
Resistor, MELF, 1M8, 1%, 0.5W	MCFRFTDU1804
Resistor, MELF, 2M2, 1%, 0.5W	MCFRFTDU2204
Resistor, MELF, 3M3, 1%, 0.5W	MCFRFTDU3304
Resistor, MELF, 4M7, 1%, 0.5W	MCFRFTDU4704
Resistor, MELF, 5M6, 1%, 0.5W	MCFRFTDU5604
Resistor, MELF, 6M8, 1%, 0.5W	MCFRFTDU6804
Resistor, MELF, 8M2, 1%, 0.5W	MCFRFTDU8204
Resistor, MELF, 22R, 1%, 0.5W	MCFRFTDU0220

**Important Notice :** This data sheet and its contents (the "Information") belong to the members of the AVNET group of companies (the "Group") or are licensed to it. No licence is granted for the use of it other than for information purposes in connection with the products to which it relates. No licence of any intellectual property rights is granted. The Information is subject to change without notice and replaces all data sheets previously supplied. The Information supplied is believed to be accurate but the Group assumes no responsibility for its accuracy or completeness, any error in or omission from it or for any use made of it. Users of this data sheet should check for themselves the Information and the suitability of the products for their purpose and not make any assumptions based on information included or omitted. Liability for loss or damage resulting from any reliance on the Information or use of it (including liability resulting from negligence or where the Group was aware of the possibility of such loss or damage arising) is excluded. This will not operate to limit or restrict the Group's liability for death or personal injury resulting from its negligence. Multicomp Pro is the registered trademark of Premier Farnell Limited 2019.

Newark.com/multicomp-pro  
 Farnell.com/multicomp-pro  
 sg.element14.com/b/multicomp-pro

