

Residual Current Circuit-breaker (RCCB) FH 200 Series



Technical Data	FH200
Standards	IEC/EN 61008
Type (wave form of the earth leakage sensed)	AC
Poles	2P, 4P
Rated current I_n	25, 40, 63 A
Rated sensitivity $I_{\Delta n}$	30, 100, 300 mA
Rated voltage U_n	230/400 - 240/415 V
Insulation voltage U_i	500 V
Max. operating voltage of circuit test	254 V
Min. operating voltage of circuit test	110 V
Rated frequency	50, 60 Hz
Dielectric test voltage at ind. freq. for 1 min.	2.5 kV
Mechanical features	
Toggle	BLACK sealable in ON-OFF position
Contact position indicator (CPI)	not available
Ambient temperature (with daily average $\leq +35$ °C)	-5...+40 °C
Storage temperature	-40...+70 °C
Installation	
Terminal type	Failsafe bi-directional cylinder-lift terminal at top and bottom (shock protected)
Terminal size top/bottom for cable	25/25 mm ²
Terminal size top/bottom for busbar	10/10 mm ²
Tightening torque	2.8 N*m
Connection	from top and bottom
Accessories mountability	No

Residual Current Circuit-breaker (RCCB)

FH 200 Series



3

Product Description	Product Code	Current Rating (A)	Residual rated current (mA)	M.R.P.(₹)	Pack Unit (Pc)
Two pole					
FH202 AC-25/0.03	1SYF202006R1250	25	30		1
FH202 AC-25/0.1	1SYF202006R2250	25	100		1
FH202 AC-25/0.3	1SYF202006R3250	25	300		1
FH202 AC-40/0.03	1SYF202006R1400	40	30		1
FH202 AC-40/0.1	1SYF202006R2400	40	100		1
FH202 AC-40/0.3	1SYF202006R3400	40	300		1
FH202 AC-63/0.03	1SYF202006R1630	63	30		1
FH202 AC-63/0.1	1SYF202006R2630	63	100		1
FH202 AC-63/0.3	1SYF202006R3630	63	300		1
Four pole					
FH204 AC-25/0.03	1SYF204006R1250	25	30		1
FH204 AC-25/0.1	1SYF204006R2250	25	100		1
FH204 AC-25/0.3	1SYF204006R3250	25	300		1
FH204 AC-40/0.03	1SYF204006R1400	40	30		1
FH204 AC-40/0.1	1SYF204006R2400	40	100		1
FH204 AC-40/0.3	1SYF204006R3400	40	300		1
FH204 AC-63/0.03	1SYF204006R1630	63	30		1
FH204 AC-63/0.1	1SYF204006R2630	63	100		1
FH204 AC-63/0.3	1SYF204006R3630	63	300		1

■ Stock items

Residual Current Circuit-breaker (RCCB) F 200 Series

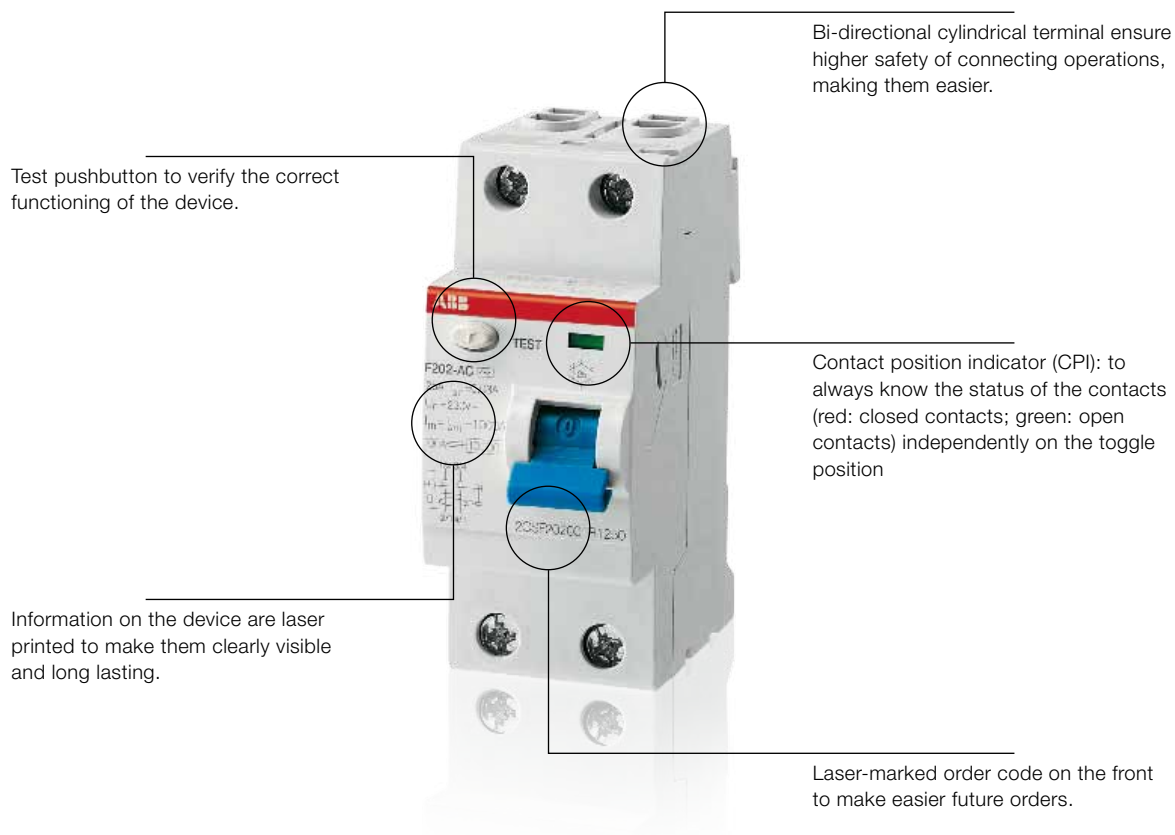

3

Technical Data	F200	
Standards	IEC/EN 61008	
Type (wave form of the earth leakage sensed)	AC	A
Poles	2P, 4P	
Rated current I_n	25, 40, 63, 80, 100 & 125 A	
Rated sensitivity $I_{\Delta n}$	30, 100, 300 mA	
Rated voltage U_n	230/400 - 240/415 V	
Insulation voltage U_i	500 V	
Max. operating voltage of circuit test	254 V	
Min. operating voltage of circuit test	110 V	
Rated frequency	50..60 Hz	
Dielectric test voltage at ind. freq. for 1 min.	2.5 kV	
Mechanical features		
Toggle	BLUE sealable in ON-OFF position	
Contact position indicator (CPI)	yes	
Ambient temperature (with daily average $\leq +35$ °C)	-25...+55 °C	
Storage temperature	-40...+70 °C	
Installation		
Terminal type	Failsafe bi-directional cylinder-lift terminal at top and bottom (shock protected)	
Terminal size top/bottom for cable	25/25 mm ²	
Terminal size top/bottom for busbar	10/10 mm ²	
Tightening torque	2.8 N*m	
Connection	from top and bottom	
Accessories mountability	Yes	

Residual Current Circuit-breaker (RCCB) F 200 Series



3

Product Description	Product Code	Current Rating (A)	Residual rated current (mA)	M.R.P.(₹)	Pack Unit (Pc)
Two pole					
F202 AC-25/0,03	1SYF202005R1250	25	30		1
F202 AC-25/0,1	1SYF202005R2250	25	100		1
F202 AC-25/0,3	1SYF202005R3250	25	300		1
F202 AC-40/0,03	1SYF202005R1400	40	30		1
F202 AC-40/0,1	1SYF202005R2400	40	100		1
F202 AC-40/0,3	1SYF202005R3400	40	300		1
F202 AC-63/0,03	1SYF202005R1630	63	30		1
F202 AC-63/0,1	1SYF202005R2630	63	100		1
F202 AC-63/0,3	1SYF202005R3630	63	300		1
F202 AC-80/0,03	2CSF202005R1800	80	30		1
F202 AC-80/0,1	2CSF202005R2800	80	100		1
F202 AC-80/0,3	2CSF202005R3800	80	300		1
F202 AC-100/0,03	2CSF202005R1900	100	30		1
F202 AC-100/0,1	2CSF202005R2900	100	100		1
F202 AC-100/0,3	2CSF202005R3900	100	300		1
Four pole					
F204 AC-25/0,03	1SYF204005R1250	25	30		1
F204 AC-25/0,1	1SYF204005R2250	25	100		1
F204 AC-25/0,3	1SYF204005R3250	25	300		1
F204 AC-40/0,03	1SYF204005R1400	40	30		1
F204 AC-40/0,1	1SYF204005R2400	40	100		1
F204 AC-40/0,3	1SYF204005R3400	40	300		1
F204 AC-63/0,03	1SYF204005R1630	63	30		1
F204 AC-63/0,1	1SYF204005R2630	63	100		1
F204 AC-63/0,3	1SYF204005R3630	63	300		1
F204 AC-80/0,03	2CSF204005R1800	80	30		1
F204 AC-80/0,1	2CSF204005R2800	80	100		1
F204 AC-80/0,3	2CSF204005R3800	80	300		1
F204 AC-100/0,03	2CSF204005R1900	100	30		1
F204 AC-100/0,1	2CSF204005R2900	100	100		1
F204 AC-100/0,3	2CSF204005R3900	100	300		1
F204 AC-125/0,03	2CSF204001R1950	125	30		1
F204 AC-125/0,1	2CSF204001R2950	125	100		1
F204 AC-125/0,3	2CSF204001R3950	125	300		1

Residual Current Circuit-breaker with Over current Protection

RCBO - DS200M series



Features

- Complies to standard to IEC/EN 61009
- DS201 available in 4.5kA, 6kA & 10kA breaking capacity.
- Available in AC, A and APR types to meet all protection needs
- B and C characteristics with rated current up to 40 A available on all the versions
- Contact Position Indicator (CPI) to indicate the exact information of the circuit-breaker status
- Equipped with an RFID tag accor. to standard ISO/IEC FCD 15693-3 to authenticate the product.
- Bidirectional cylinder-lift terminals for easier the parallel feed
- Flag indicators - Differential trip indicator - blue
 - Contact position indicator - green / red

Description	Ordering Code	Current Rating (A)	Residual rated current (mA)	M.R.P.(₹)	Pack Unit (Pc)
-------------	---------------	--------------------	-----------------------------	-----------	----------------

RCBO 10kA AC Type - DS200M

DS201 M C6 AC30	2CSR275040R1064	6	30		1
DS201 M C6 AC100	2CSR275040R2064	6	100		1
DS201 M C6 AC300	2CSR275040R3064	6	300		1
DS201 M C10 AC30	2CSR275040R1104	10	30		1
DS201 M C10 AC100	2CSR275040R2104	10	100		1
DS201 M C10 AC300	2CSR275040R3104	10	300		1
DS201 M C16 AC30	2CSR275040R1164	16	30		1
DS201 M C16 AC100	2CSR275040R2164	16	100		1
DS201 M C16 AC300	2CSR275040R3164	16	300		1
DS201 M C20 AC30	2CSR275040R1204	20	30		1
DS201 M C20 AC100	2CSR275040R2204	20	100		1
DS201 M C20 AC300	2CSR275040R3204	20	300		1
DS201 M C25 AC30	2CSR275040R1254	25	30		1
DS201 M C25 AC100	2CSR275040R2254	25	100		1
DS201 M C25 AC300	2CSR275040R3254	25	300		1
DS201 M C32 AC30	2CSR275040R1324	32	30		1
DS201 M C32 AC100	2CSR275040R2324	32	100		1
DS201 M C32 AC300	2CSR275040R3324	32	300		1
DS201 M C40 AC30	2CSR275040R1404	40	30		1
DS201 M C40 AC100	2CSR275040R2404	40	100		1
DS201 M C40 AC300	2CSR275040R3404	40	300		1

Residual Current Circuit-breaker with Over current Protection Blocks

RCD Blocks - DDA200 series

3

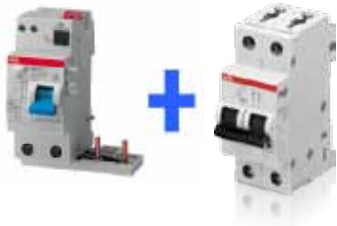

DDA - 200 AC type

Function: RCD-block for assembly on site with MCBs S 200M series. Protection against the effects of sinusoidal alternating earth fault currents; protection against indirect contacts and additional protection against direct (with $I_{\Delta n}=30$ mA) contacts.

Standard: IEC/EN 61009 Ann. G

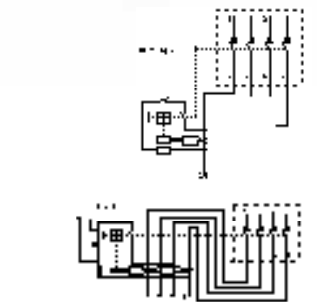
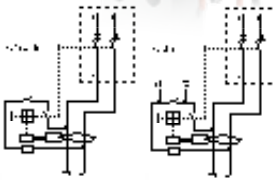

DDA 200 AC

Description	Ordering Code	Current Rating (A)	Residual rated current (mA)	M.R.P.(₹)	Pack Unit (Pc)
Two pole					
DDA202 AC-63/0.03	2CSB202001R1630	63	30		1
DDA202 AC-63/0.1	2CSB202001R2630	63	100		1
DDA202 AC-63/0.3	2CSB202001R3630	63	300		1

Four pole

DDA204 AC-25/0.03	2CSB204001R1250	25	30		1
DDA204 AC-40/0.03	2CSB204001R1400	40	30		1
DDA204 AC-63/0.03	2CSB204001R1630	63	30		1
DDA204 AC-25/0.1	2CSB204001R2250	25	100		1
DDA204 AC-40/0.1	2CSB204001R2400	40	100		1
DDA204 AC-63/0.1	2CSB204001R2630	63	100		1
DDA204 AC-25/0.3	2CSB204001R3250	25	300		1
DDA204 AC-40/0.3	2CSB204001R3400	40	300		1
DDA204 AC-63/0.3	2CSB204001R3630	63	300		1

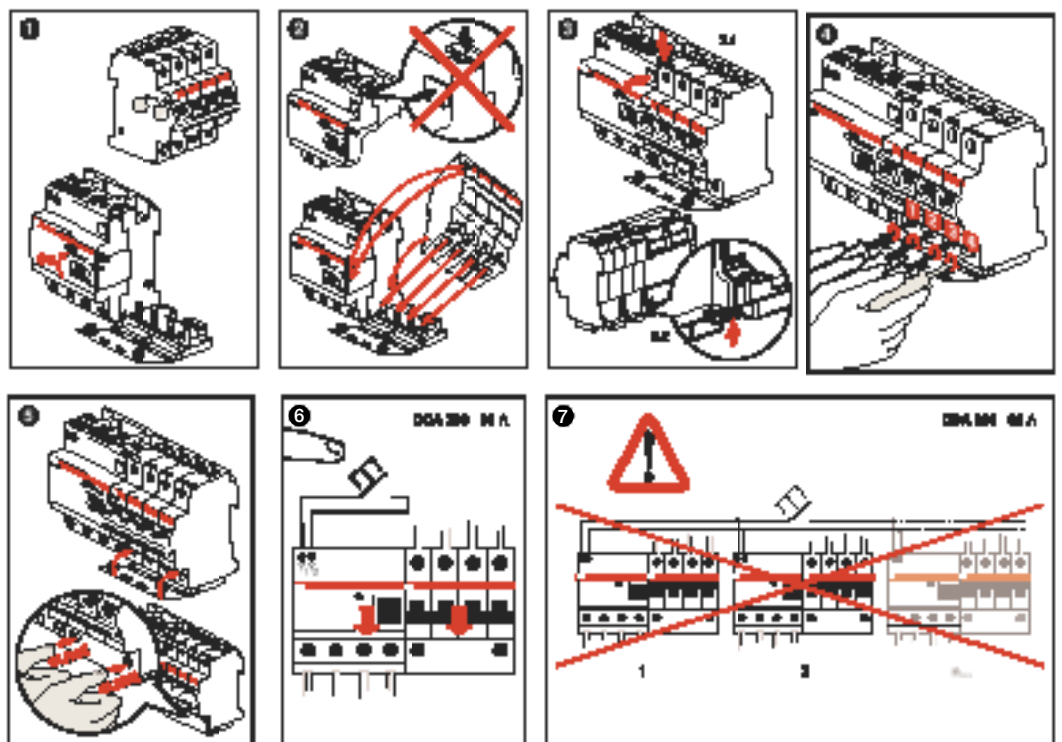

Solution for unwanted tripping - AP-R type (high immunity) RCCB / RCBO

The ABB range of AP-R anti-disturbance residual current circuit-breakers and blocks was designed to overcome the problem of unwanted tripping due to overvoltages of atmospheric or operational origin.

The electronic circuit in these devices can distinguish between temporary leakage caused by disturbances on the mains and permanent leakage due to actual faults, only breaking the circuit in the latter case.

AP-R residual current circuit-breakers and blocks have a slight delay into the tripping time, but this does not compromise the safety limits set by the Standards in force (release time at $2 I_{\Delta n}=150$ ms).

Compared with standard type breakers, AP-R residual current breakers are therefore characterised, for any given sensibility, by:

- Higher residual trip current
- Tripping time delay
- Better resistance to overvoltages, harmonics and impulse disturbances.

Guaranteeing conventional residual current protection, their installation in the electrical circuit therefore allows any unwanted tripping to be avoided in domestic and industrial systems in which service continuity is essential.

This delay makes the AP-R residual current devices especially

suited for installations involving motor starters/variable speed drives, fluorescent lamps or IT/electronic equipment.

The use of multiple electronic reactors for the supply of fluorescent lamps instead generates permanent leakage currents and inrush currents that can cause nuisance tripping of a standard residual current circuit breaker.

IT system loads and other electronic equipment (e.g. dimmers, computers, inverters) with capacitive input filters connected between the phases and ground can also generate permanent earth leakage currents whose sum may provoke the nuisance tripping of a standard residual current circuit breaker. For these situations, the AP-R breakers allow a greater number of devices to be connected to the installation.

Frequency converters include a rectifier section and an inverter section.

In case of fault within a single-phase frequency converter AP-R type RCDs provide complete protection, because an earth fault occurring downstream the inverter, produces an earth fault current with multi-frequency shape with high amount of harmonics.

While, in case of fault within a three-phase frequency converter, B type RCDs ensure complete protection because in case of insulation fault between the rectifier and the inverter or downstream the inverter we can have a smooth DC earth fault current.

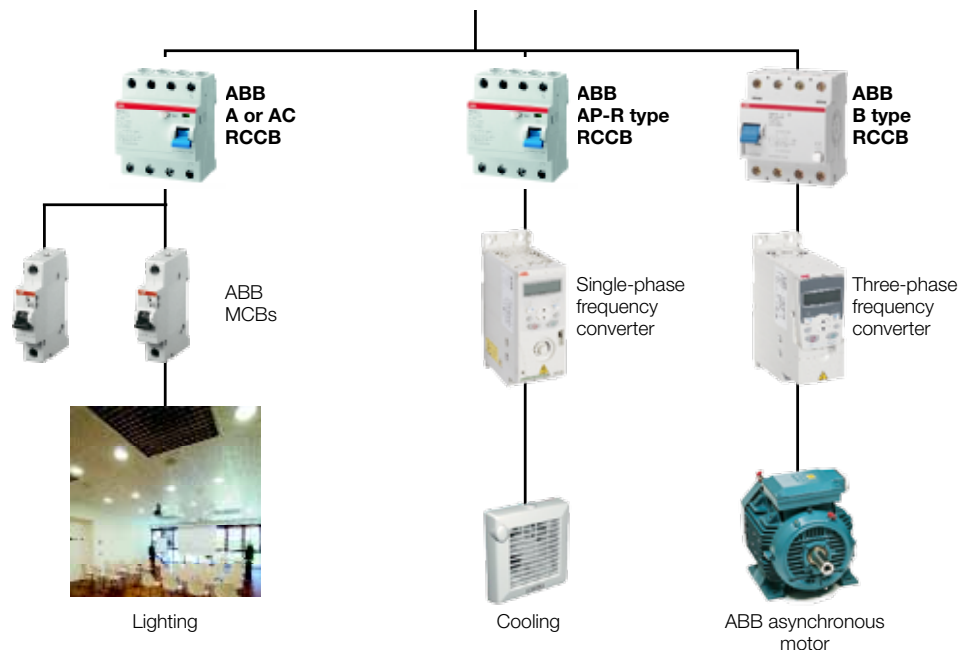

RCCB - F 200 series: AP-R (high immunity)

Function: protection against the effects of sinusoidal alternating and direct pulsating earth fault currents, providing the best compromise between safety and continuity in the service thanks to the resistance to unwanted trippings; protection against indirect contacts and additional protection against direct ($I_{\Delta n}=30$ mA) contacts.

Application: residential, commercial, industrial. **Standard:** IEC/EN 61008

Surge current resistance (wave 8/20)=3000 A **Marking:** according to EN 61008

RCCB - F 200 series

Description	Ordering Code	Current Rating (A)	Residual rated current (mA)	M.R.P.(₹)	Packing
Two pole					
F202 A-25/0.03 AP-R	2CSF202401R1250	25	30		1
F202 A-40/0.03 AP-R	2CSF202401R1400	40	30		1
F202 A-63/0.03 AP-R	2CSF202401R1630	63	30		1
Four pole					
F204 A-25/0.03 AP-R	2CSF204401R1250	25	30		1
F204 A-40/0.03 AP-R	2CSF204401R1400	40	30		1
F204 A-63/0.03 AP-R	2CSF204401R1630	63	30		1

RCBO - DS200 series A APR type (high immunity)

Function: protection against the effects of sinusoidal alternating and direct pulsating earth fault currents, providing an optimal compromise between safety and continuity of service, thanks to the resistance to unwanted tripping; protection against indirect contact and additional protection against direct ($I_{\Delta n}=30$ mA) contact; protection and isolation of resistive and inductive loads.

Application: residential, commercial, industrial. **Standard:** IEC/EN 61009

I_{cn}=10 kA

RCBO - DS200 series A APR type

Description	Ordering Code	Current Rating (A)	Residual rated current (mA)	M.R.P.(₹)	Packing
DS201 M C6 APR30	2CSR275440R1064	6	30		1
DS201 M C10 APR30	2CSR275440R1104	10	30		1
DS201 M C16 APR30	2CSR275440R1164	16	30		1
DS201 M C20 APR30	2CSR275440R1204	20	30		1
DS201 M C25 APR30	2CSR275440R1254	25	30		1
DS201 M C32 APR30	2CSR275440R1324	32	30		1
DS201 M C40 APR30	2CSR275440R1404	40	30		1
DS201 M C6 APR100	2CSR275440R2064	6	100		1
DS201 M C10 APR100	2CSR275440R2104	10	100		1
DS201 M C16 APR100	2CSR275440R2164	16	100		1
DS201 M C20 APR100	2CSR275440R2204	20	100		1
DS201 M C25 APR100	2CSR275440R2254	25	100		1
DS201 M C32 APR100	2CSR275440R2324	32	100		1
DS201 M C40 APR100	2CSR275440R2404	40	100		1
DS201 M C6 APR300	2CSR275440R3064	6	300		1
DS201 M C10 APR300	2CSR275440R3104	10	300		1
DS201 M C16 APR300	2CSR275440R3164	16	300		1
DS201 M C20 APR300	2CSR275440R3204	20	300		1
DS201 M C25 APR300	2CSR275440R3254	25	300		1
DS201 M C32 APR300	2CSR275440R3324	32	300		1
DS201 M C40 APR300	2CSR275440R3404	40	300		1

Auxiliary elements for MCBs S 200, RCDs F 200 and DS 200

Selection tables

3



S2C-S/H6R

S2C-H6...

Signal/auxiliary contacts

Function S2C-S/H6R: choice through a selector between indication of the position of the device's contacts and signalling of the fault (overcurrent/short-circuit for MCBs and RCBOs; earth fault for RCCBs and RCBOs). Suitable for MCBs S 200 series, RCCBs F 200 series, RCBOs DS201, DS202C, DS 200 series.

Function S2C-H6R: indication of the position of the device's contacts. Suitable for MCBs S200 series. To be mounted on the left side of the MCBs thanks to the special pin. They are not suitable to be mounted together with RCD-block DDA200.

Function S2C-H6-xxR: indication of the position of the MCB contact. Mounted on the right side. They are not suitable to be mounted together with other right side mounted auxiliary contacts.

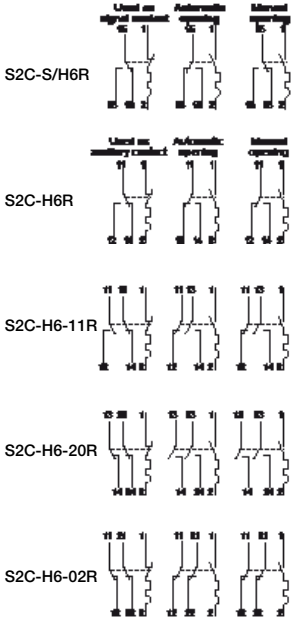

Description	Order details	Ordering Code	M.R.P.(₹)	Packing
Auxiliary Contact, 1CO (Right side)	S2C-H6R	2CDS200912R0001		1
Auxiliary Contact, 1NO / 1NC (Right side)	S2C-H6-11R	2CDS200946R0001		1
Auxiliary Contact, 2NO (Right side)	S2C-H6-20R	2CDS200946R0002		1
Auxiliary Contact, 2NC (Right side)	S2C-H6-02R	2CDS200946R0003		1
Signal contact / Auxiliary switch, 1CO (Right side)	S2C-S/H6R	2CDS200922R0001		1

Auxiliary contacts mounting on the left side

Description	Order details	Ordering Code	M.R.P.(₹)	Packing
Auxiliary Contact, 1NO / 1NC (Left side)	S2C-H11L	2CDS200936R0001		1
Auxiliary Contact, 2NO (Left side)	S2C-H20L	2CDS200936R0002		1
Auxiliary Contact, 2NC (Left side)	S2C-H02L	2CDS200936R0003		1

Bottom-fitting auxiliary contacts for S 200, S 200 M, S 200 P, S 200 S

Description	Order details	Ordering Code	M.R.P.(₹)	Packing
Bottom fitting Aux contact, 1NC	S2C-H01	2CDS200970R0001		1
Bottom fitting Aux contact, 1NO	S2C-H10	2CDS200970R0002		1



Shunt trips

Function: remote opening of the device when a voltage is applied. Suitable for MCBs S 200 series and RCBOs DS 200 series.

Description	Order details	Ordering Code	M.R.P.(₹)	Packing
Shunt Trip, 12...60V AC/DC	S2C-A1	2CDS200909R0001		1
Shunt Trip, 110...415V AC, 110...250 DC	S2C-A2	2CDS200909R0002		1

Function: remote opening of the device when a voltage is applied. Suitable for RCCBs F 200 series and RCBOs DS201 and DS202C.

It can be used with MCBs SN201 series by means of SN201-IH interface module.

Description	Order details	Ordering Code	M.R.P.(₹)	Packing
Shunt Trip, 12...60V AC/DC	F2C-A1	2CSS200933R0011		1
Shunt Trip, 110...415V AC/ 110...250V DC	F2C-A2	2CSS200933R0012		1

Auxiliary elements for MCBs S 200, RCDs F 200 and DS 200

Selection tables



Undervoltage releases

Function: protection of the load in the event of a voltage drop (between 70% and 35% of its rated value); positive safety (device's tripping when the voltage is disconnected) emergency stop by means of a button. Suitable for MCBs S 200 series, RCCBs F200 series and RCBOs DS201, DS202C, DS 200 series It can be used with MCBs SN201 series by means of SN201-IH interface module.

Description	Order details	Ordering Code	M.R.P.(₹)	Packing
Undervoltage Release, 12V DC	S2C-UA 12 DC	2CSS200911R0001		1
Undervoltage Release, 24V AC	S2C-UA 24 AC	2CSS200911R0002		1
Undervoltage Release, 24V DC	S2C-UA 24 DC	2CSS200911R0007		1
Undervoltage Release, 48V AC	S2C-UA 48 AC	2CSS200911R0003		1
Undervoltage Release, 48V DC	S2C-UA 48 DC	2CSS200911R0008		1
Undervoltage Release, 110V AC	S2C-UA 110 AC	2CSS200911R0004		1
Undervoltage Release, 110V DC	S2C-UA 110 DC	2CSS200911R0009		1
Undervoltage Release, 230V AC	S2C-UA 230 AC	2CSS200911R0005		1
Undervoltage Release, 230V DC	S2C-UA 230 DC	2CSS200911R0010		1
Undervoltage Release, 400V AC	S2C-UA 400 AC	2CSS200911R0006		1



Overvoltage releases

Function: monitoring voltage between the neutral and phase; when an overvoltage reaches the threshold value, the OVP device causes the tripping of the associated MCB or RCCB.

Suitable for MCBs of the S200 series up to 63 A, and RCCBs of the F200 series up to 100 A and RCBOs DS201 and DS202C series.

Description	Order details	Product Code	M.R.P.(₹)	Packing
Over Voltage Release (Max tripping : 275 V AC)	S2C-OVP1	2CSS200910R0005		1
Over Voltage Release (Max tripping : 290 V AC)	S2C-OVP2	2CSS200993R0005		1



Hand operated neutral

The hand operated neutral has to be mounted to the left side of the MCB and be snapped on the DIN rail. It is used for measuring duties where the neutral conductor must be in the open position. Due to the special design of the handle - when switching ON the MCB - the neutral will make before the MCB is closed.

The S2C - Nt is not to switch with a tool (screw driver).

Description	Order details	Product Code	M.R.P.(₹)	Packing
Hand operated Neutral (Right side)	S2C-NT	2CDS200918R0001		1



Auxiliary elements for MCBs S800 series

Auxiliary contact

Description	Order details	Product Code	M.R.P.(₹)	Packing
Auxiliary contact	S800-AUX	2CCS800900R0011		1

Combined auxiliary and signal contact

Description	Order details	Product Code	M.R.P.(₹)	Packing
Auxiliary/signal contact	S800-AUX/ALT	2CCS800900R0021		1

Overall dimensions

MCB - (SH200) and Isolator (SHD)

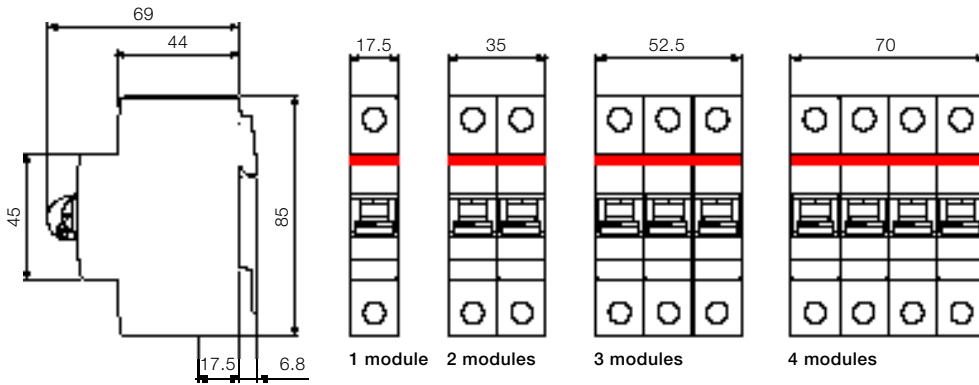

MCB - (S200)

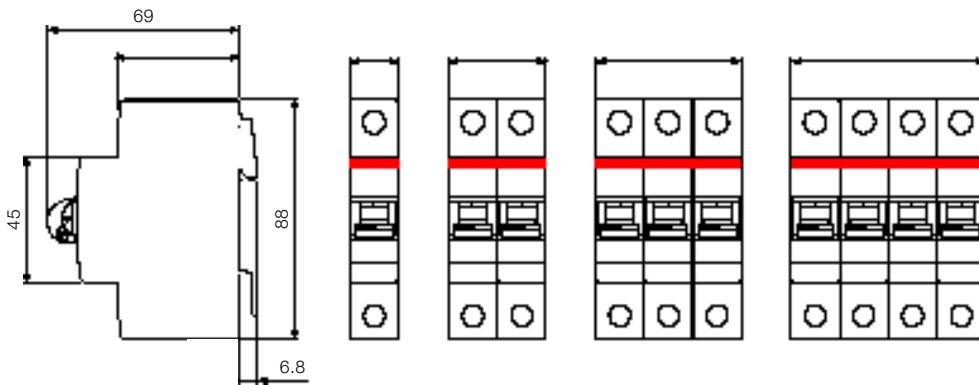

RCCB - (F200)

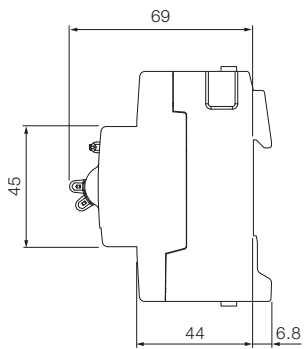

Two pole

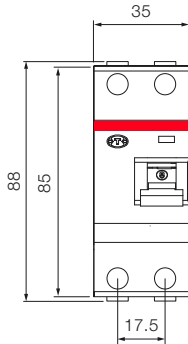

Four pole

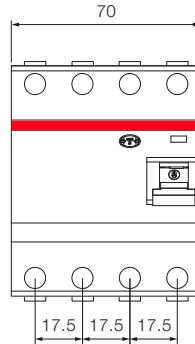

RCBO (DS200)

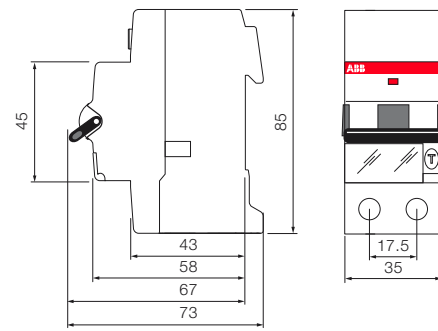

DDA 200

Two pole

In=25-63 A

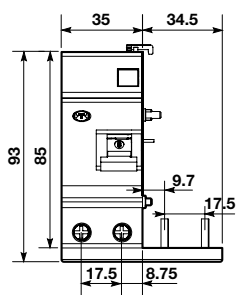

Four pole

In=25-40 A

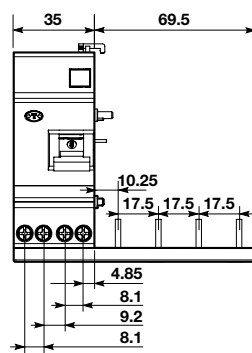

Four pole

In=63 A

