



Datasheet

RS PRO DC FAN 80x80x25mm

Stock Number: 230-3044

EN

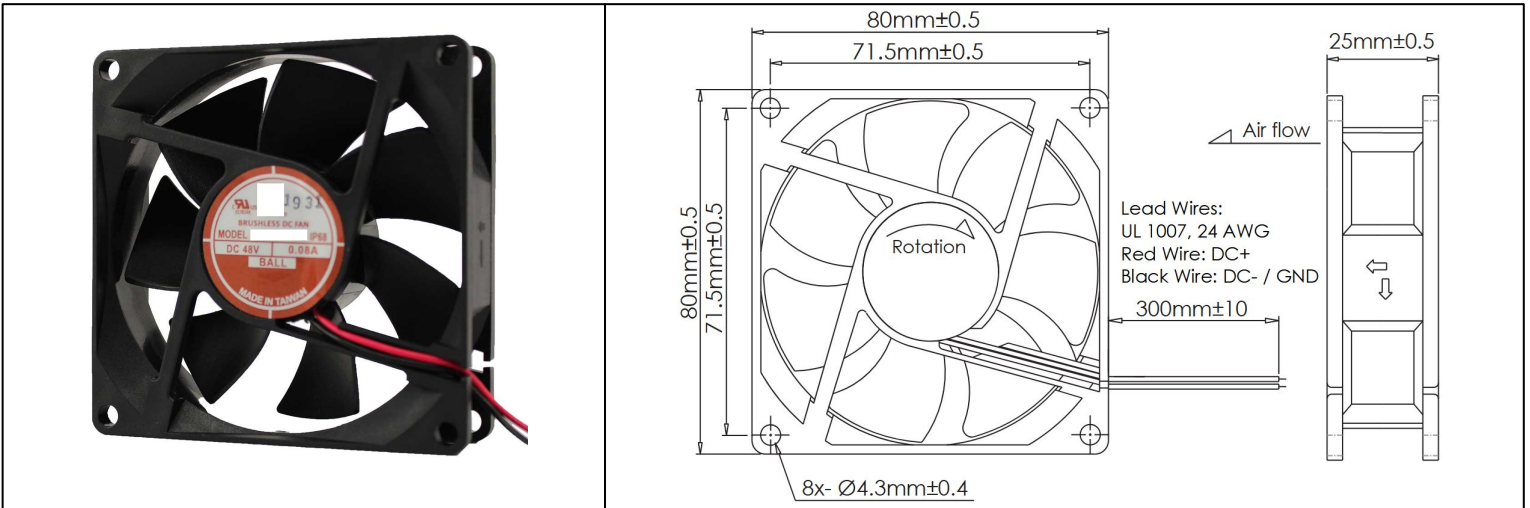

Frame	PBT, UL94 V-0 Plastic	<u>Operating Temperature</u> -15°C ~ +65°C	
Impeller	PBT, UL94 V-0 Plastic	<u>Storage Temperature</u> -25°C ~ +70°C	
Connection	2x Lead Wires, 24 AWG	<u>Life Expectancy</u> 60,000 hours (L10 at 45°C)	
Motor	Brushless DC, Auto Cutoff, Auto Restart, Electronically Protected, IP68	Weight: 85g (0.19 lbs)	
Bearing System	Dual Ball Bearings		
Dielectric Strength	500VAC/min, <1mA		
Insulation Resistance	≥10M Ohm @ 500 VDC		

Model Number	
Rated Voltage	48 VDC ± 10%
Rated Power (Watts)	3.8 ± 15%
Rated Current (A)	0.08 ± 15%
Rated Speed (RPM)	3300 ± 15%
Airflow (CFM)	40 ± 15%
Noise Level (dB)	33
Max. Static Pressure	0.23" H ₂ O ± 15%