

Datasheet

Black/White SPST Rocker Switch

RS Stock number [419-798](#)

Dimensions: (mm)

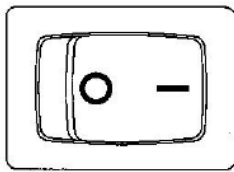

Material:
 Frame: Nylon#66, Black
 Actuator: Nylon#66, Black
 Printed: White, hot stamping

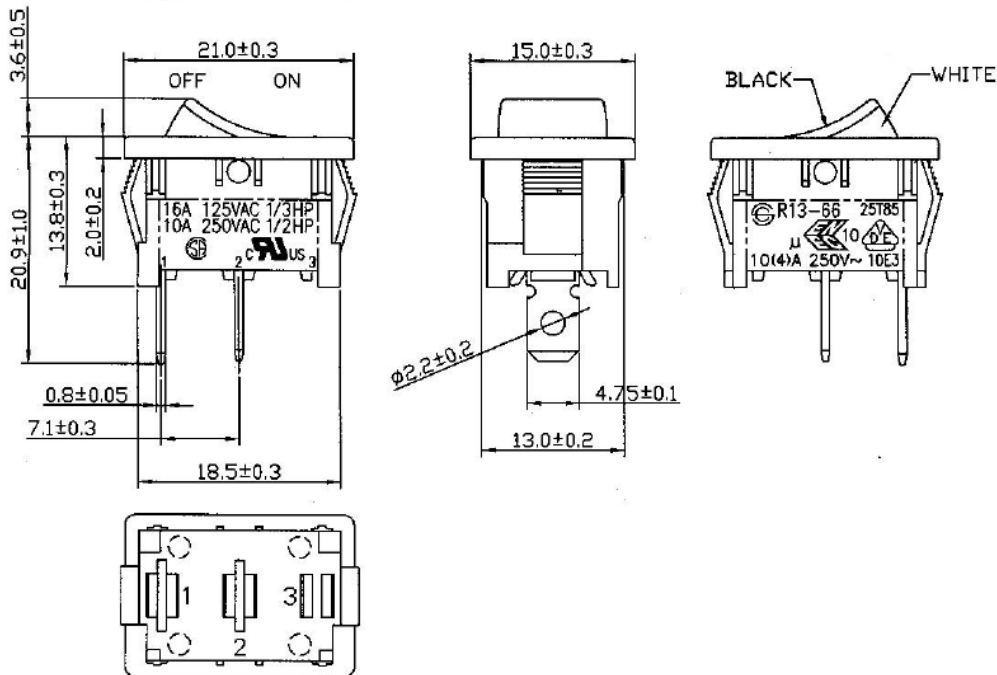

Specifications

- Rating: 10A, 125V, 6A, 250V AC
- Contact R: 50m ohm Max
- Insulation R: DC 500V 100M ohm Min
- Dielectric Strength: AC 1500V 1 minute
- Operating Temperature: -20°C ~ 85°C
- Circuit: 3P SPST ON-OFF