

Datasheet

# Stainless Steel Female Clamping Handle

RS Stock No: 1443599

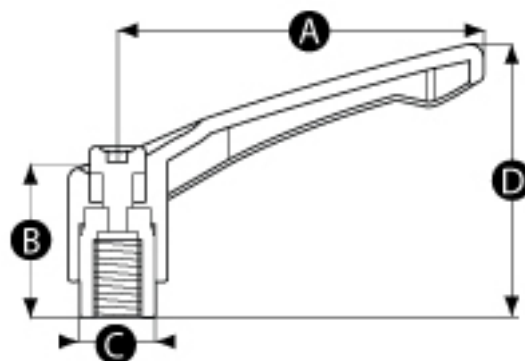

## Specification

Handle material: Stainless steel - 304

Thread, ratchet and spring: Stainless steel - 304



ENGLISH

Stock no	A	B	C	D	Thread size
1443594	42	18	10	34	M5
1443595	42	18	10	34	M6
1443596	65	21	14	44	M6
1443597	65	21	14	44	M8
1443599	78	24	16	51	M8
1443598	78	24	16	51	M10
1443601	92	28	19	60	M10
1443602	92	28	19	60	M12
1443591	108	33	23	69	M12
1443592	108	33	23	69	M16