

FRONT VIEW

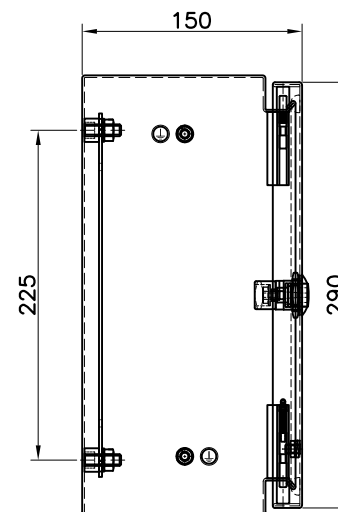

SIDE VIEW

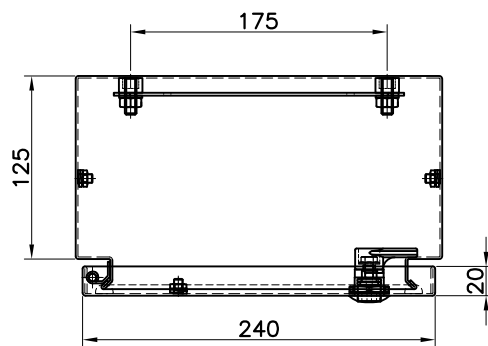

TOP VIEW

ALL DIMENSIONS ARE IN MILLIMETRES

No.	Revision note	Edit	Date



Date 04-01-2012	Material 1.2mm S.S(AISI 304)	Finish NATURAL, CLEAN	Scale N.T.S.
STAINLESS STEEL BOX IP66 250x300x150			
Ord. No. 7491822	Sheet A4	Tolerances ±0.2	