

Datasheet

RS PRO BATTERY HOLDER, PCB THROUGH HOLE, FOR CR2450 DIP TYPE COLOR: BLACK

Stock No: **2378284, 2378285**



Product Details:

RS PRO Battery Holders, Battery Snaps, Spring Connectors, and Mobile Battery Connectors are designed to create connections and contain batteries in electronic equipment. This series includes battery holders and coin cell holders for AAA, AA, C, D, 9V and lithium coin cells. Adam Tech produces this series in a variety of terminations such as through hole PCB leads, SMT leads, wire leads and solder lugs. Custom lead lengths on wire configurations are also available. Our superior retention holders are molded of UL-94V0 or UL-94HB material with spring steel contacts and perform extremely well under normal or adverse environment conditions.

Features & Benefits:

- Single and Multiple Cell
- Reliable spring tension contacts assures low contact resistance
- Rugged construction
- Light Weight

SPECIFICATIONS:

Material:

Housing: PBT, Glass reinforced, rated UL94V-0, Color: Black

Contact: Phosphor Bronze, Nickel plated

Electrical:

Contact resistance: 30 mohms max

Insulation resistance: 1,000 Mohms min

Dielectric Voltage: 500 VAC one sec level

Temperature Rating:

Operating temperature: -25°C to +85°C.

Environmental:

Lead free, RoHS compliant

Dimensional line drawings

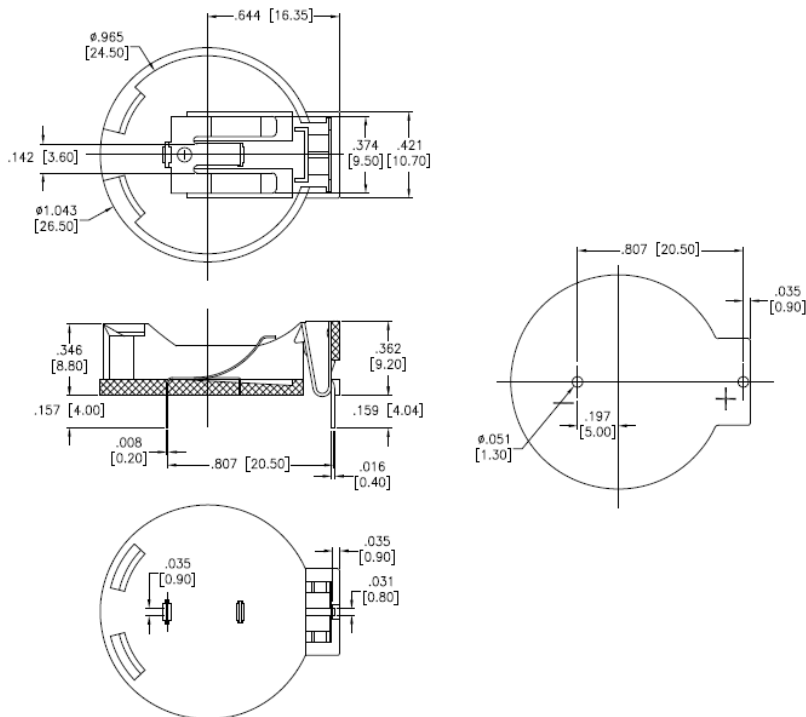

General

Extra page for more complex