

FEATURES

- Sandblasted finish with 3 mm wall thickness
- Neoprene gasket for IP65 protection
- Temperature range; -40°C to +100°C
- Four recessed screws secure lid into tapped holes
- Slots provided for mounting PCBs
- DIN rail can be fixed to the base
- The enclosure comes complete with a numbers of accessories and fittings. A neoprene gasket, captive screws and grounding screw fixings.

RS PRO General Purpose Enclosures-Die Cast Aluminium Enclosure

RS Stock No.: 282-1203



RS Professionally Approved Products bring to you professional quality parts across all product categories. Our product range has been tested by engineers and provides a comparable quality to the leading brands without paying a premium price.

Product Description

RS Pro IP65 Aluminium Enclosure With PCB Slots

From RS Pro, this aluminium enclosure provides maximum protection from the flanges, making it perfect for housing electrical components. Made of aluminium alloy with a smooth unpainted finish. As standard, the rails inside allow PCB's or other types of boards to be fitted. Fixings holes are external, keeping the gasket seal intact. The gasket has a continuous neoprene gasket to prevent leakages into the enclosure. All models are highly reliable and excellent quality.

General Specifications

Body Material	Die Cast Aluminium
Colour	Grey
Lid Colour	Grey
Number of Knockouts	2
Handheld	No
Flanged	No
Shielded	No
Transparent Door	No
Cover Screws Material	Stainless Steel
Temperature Range (Continuous)	-40°C to +100°C

Mechanical Specifications

Gasket Material	Neoprene
External Height	75 mm
External Length	122 mm
External Width	75mm
External Dimension	122 x 75 x 75mm
Weight	2.7kg
Thickness	-40°C to +100°C

Protection Category

IP Rating	IP65
-----------	------

Approvals

Declarations	RoHS Certificate of Compliance
--------------	--------------------------------

Similar Products

Stock No.	Brand	Product Name	Body Material	Colour	Shielded
846-3027	RS PRO	Die Cast Aluminium Enclosure	Die Cast Aluminium	Grey	No
621-5028	RS PRO	Die Cast Aluminium Enclosure	Die Cast Aluminium	Grey	Yes

Including: Base with screws for mounting plate/DIN-rail, cover with PUR gasket and stainless steel cover screws

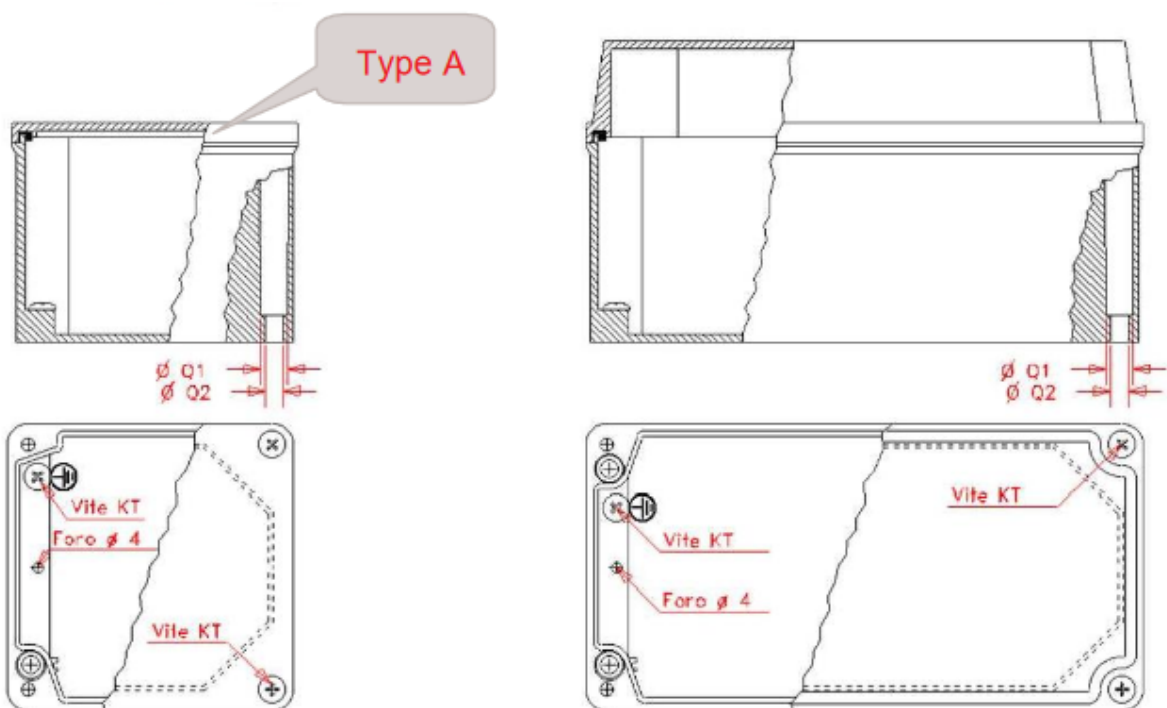

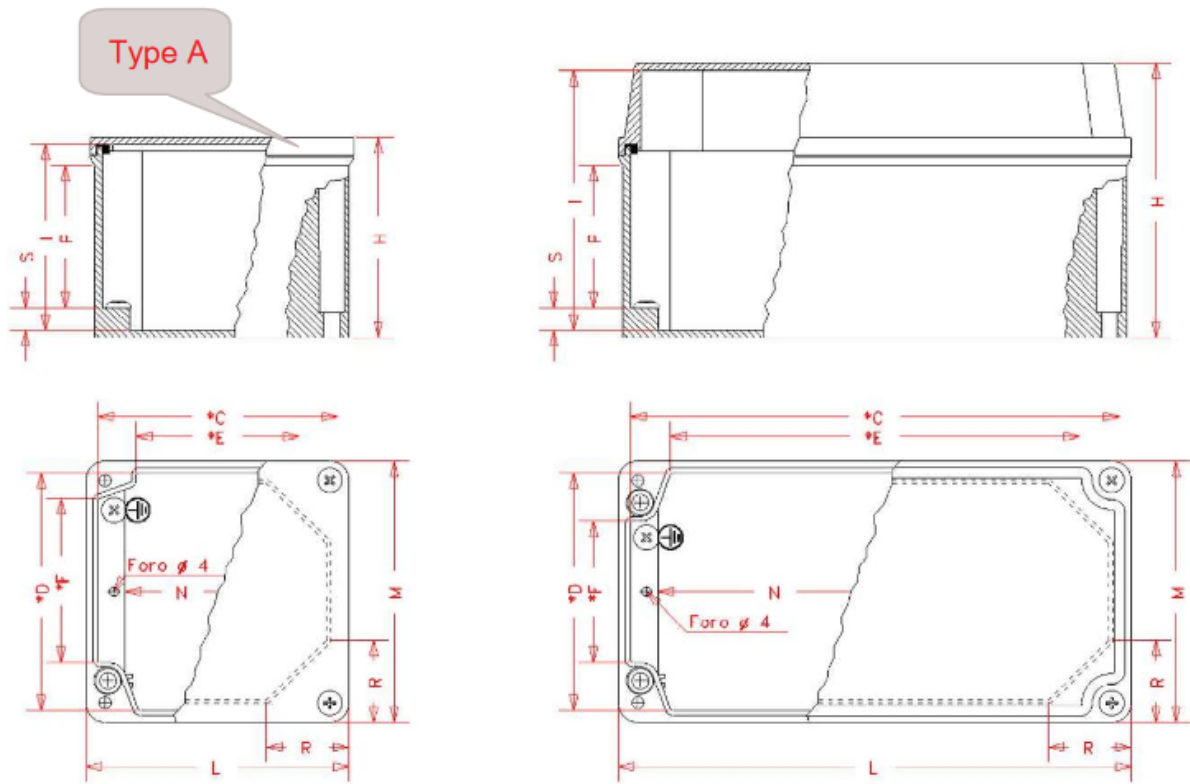

Type A enclosure: flat cover and 2 fixing holes on the bottom.