

1.5mm Box Header

Single Row, 180 SMT Type

multicomp PRO

**RoHS
Compliant**

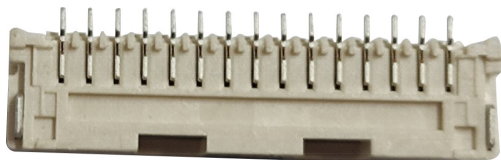

Specifications

Voltage rating	: 100V AC / DC
Current rating	: 2A AC / DC
Withstanding voltage	: 500V AC/minute
Temperature range	: -40°C to +105°C
Insulation resistance	: $\geq 500M\Omega$
Contact resistance	: $\leq 20m\Omega$
After environmental testing	: $\leq 40m\Omega$

Diagram

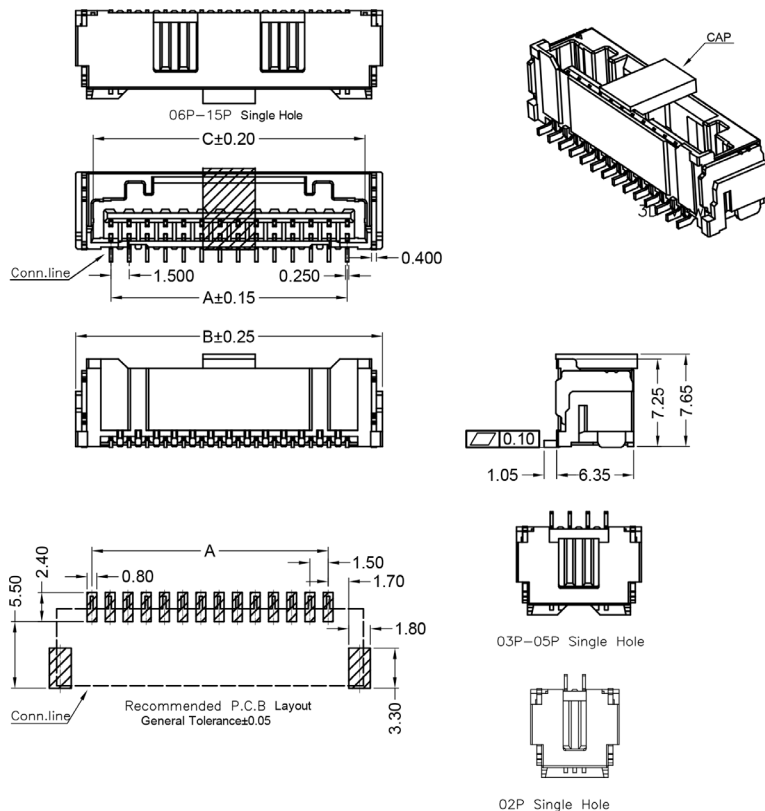

No.	Description	Material	Remarks	QTY
1	Housing	LCP	Natural	1
2	PIN	Phorphos Bronze	Matte Tin 40u" Min.	*
3	Stator	Brass	Matte Tin 40u" Min	1

Dimensions : Millimetres

Newark.com/multicomp-pro
Farnell.com/multicomp-pro
sg.element14.com/b/multicomp-pro

multicomp PRO

1.5mm Box Header

Single Row, 180 SMT Type

multicomp PRO

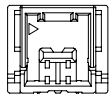

2 PIN

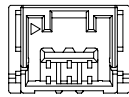

3 PIN

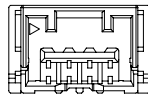

4 PIN

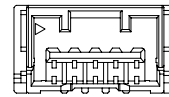

5 PIN

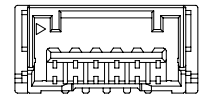

6 PIN

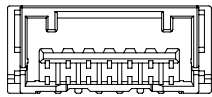

7 PIN

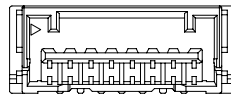

8 PIN

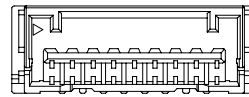

9 PIN

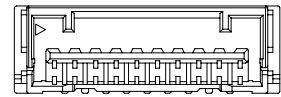

10 PIN

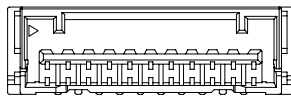

11 PIN

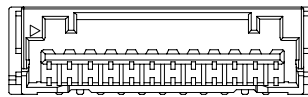

12 PIN

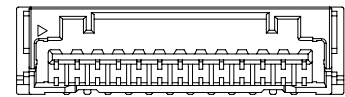

13 PIN

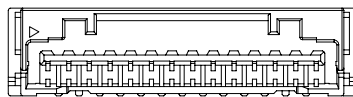

14 PIN

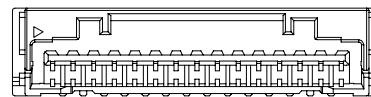

15 PIN

Poles	Dimensions			Poles	Dimensions		
	A	B	C		A	B	C
02	1.5	7.3	4.45	09	12	17.8	14.95
03	3	8.8	5.95	10	7.5	19.3	16.45
04	4.5	10.3	7.45	11	15	20.8	17.95
05	6	11.8	8.95	12	16.5	22.3	19.45
06	7.5	13.3	10.45	13	18	23.8	20.95
07	9	14.8	11.95	14	19.5	25.3	22.45
08	10.5	16.3	13.45	15	21	26.8	23.95

Dimensions : Millimetres

1.5mm Box Header

Single Row, 180 SMT Type

multicomp PRO

Part Number Table

Description	Part Number
Header, 1.5mm, 2Pins, Single Row, SMT	MP011285
Header, 1.5mm, 3Pins, Single Row, SMT	MP011286
Header, 1.5mm, 4Pins, Single Row, SMT	MP011287
Header, 1.5mm, 5Pins, Single Row, SMT	MP011288
Header, 1.5mm, 6Pins, Single Row, SMT	MP011289
Header, 1.5mm, 7Pins, Single Row, SMT	MP011290
Header, 1.5mm, 8Pins, Single Row, SMT	MP011291
Header, 1.5mm, 9Pins, Single Row, SMT	MP011292
Header, 1.5mm, 10Pins, Single Row, SMT	MP011293
Header, 1.5mm, 11Pins, Single Row, SMT	MP011294
Header, 1.5mm, 12Pins, Single Row, SMT	MP011295
Header, 1.5mm, 13Pins, Single Row, SMT	MP011296
Header, 1.5mm, 14Pins, Single Row, SMT	MP011297
Header, 1.5mm, 15Pins, Single Row, SMT	MP011298

Important Notice : This data sheet and its contents (the "Information") belong to the members of the AVNET group of companies (the "Group") or are licensed to it. No licence is granted for the use of it other than for information purposes in connection with the products to which it relates. No licence of any intellectual property rights is granted. The Information is subject to change without notice and replaces all data sheets previously supplied. The Information supplied is believed to be accurate but the Group assumes no responsibility for its accuracy or completeness, any error in or omission from it or for any use made of it. Users of this data sheet should check for themselves the Information and the suitability of the products for their purpose and not make any assumptions based on information included or omitted. Liability for loss or damage resulting from any reliance on the Information or use of it (including liability resulting from negligence or where the Group was aware of the possibility of such loss or damage arising) is excluded. This will not operate to limit or restrict the Group's liability for death or personal injury resulting from its negligence. Multicomp Pro is the registered trademark of Premier Farnell Limited 2019.

Newark.com/multicomp-pro
Farnell.com/multicomp-pro
sg.element14.com/b/multicomp-pro

multicomp PRO