

VALVE LOCKOUT

Lockout is a choice you make.
Safety is the destination LOTOTO achieve

Lototo

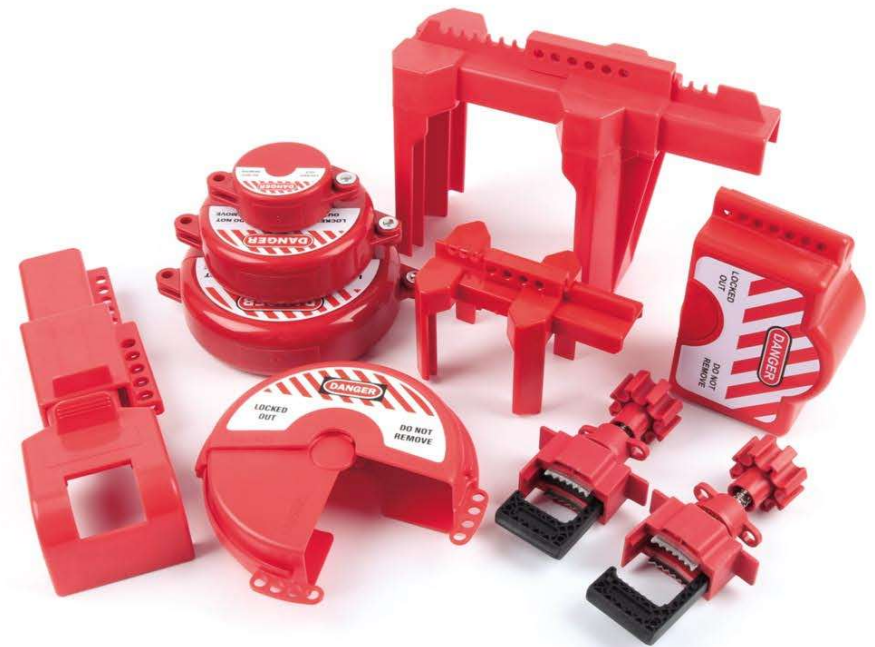

Lototo

Valve lockout devices shutoff many kinds of pressured valves including: ball valve, butterfly valve, cylinder valve, gate valve, plug valve and pneumatic. Adjustable and universal devices are available for additional flexibility.

ADJUSTABLE BALL VALVE LOCKOUT

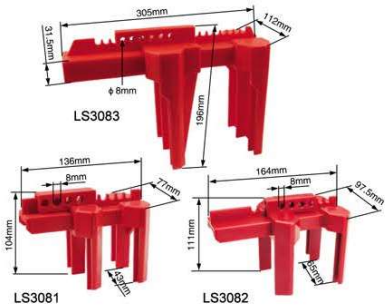

Part No.	Description
LS3081	Suitable for pipes 1/2" to 2.5" in diameter, OPEN on pipes from 1/2" to 1.25"
LS3082	Suitable for pipes 1/2" to 3.15" in diameter, OPEN on pipes from 1/2" to 2.5"
LS3083	Suitable for pipes 2" to 8" in diameter



- Made from durable ABS, withstand temperature from -20°C to +90°C, highly resistant of cracking and abrasion and supports extreme weather temperature conditions.
- The two halves of the lockout encompass the ball valve handle to secure it from inadvertent activation of the valve handle.
- Suggested be equipped together with padlocks with max clamping shackle diameter of 8mm.

Part No.	Description
LS3471	Suitable for pipes diameter from 9.5mm (3/8") to 31mm (1 1/5")
LS3472	Suitable for pipes diameter from 9.5mm (3/8") to 31mm (1 1/5"), with front and back foot board
LS3473	Suitable for pipes diameter from 13mm (1/2") to 70mm (2 3/4")
LS3474	Suitable for pipes diameter from 13mm (1/2") to 70mm (2 3/4"), with front and back foot board
LS3475	Suitable for pipes diameter from 73mm (2 4/5") to 215mm (8 1/2")

ADJUSTABLE BALL VALVE LOCKOUT

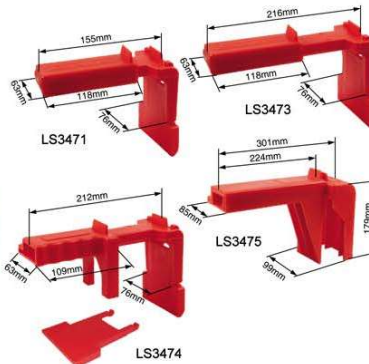

- Made from ABS, withstand temperature from -20°C to +90°C.
- Removable insert accommodates a wide range of handle designs and dimensions.
- It has an auxiliary rear plate, which can lock out double roll valves.

UNIVERSAL BALL VALVE LOCKOUT

Part No.	Description
LS3068	Suitable for valve diameters 6mm(1/4") to 101mm(4") and works on insulated pipes and in close quarters

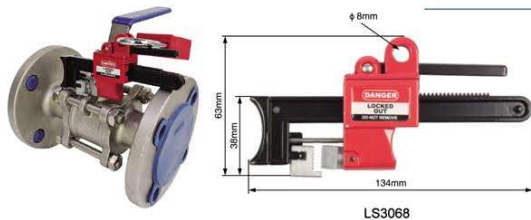

- Made from zinc alloy, surface treatment by high temperature spraying, rust proof.
- Designed to lock out different types of ball valve, clamp tight on handle stop to prevent handle movement.
- Device encloses the valve stem, with the handle removed, to make accidental reactivation virtually impossible.
- Accept up to 1 padlock, locking shackle max diameter 8mm.
- Can be equipped together with hasps for multiple lockout usage.

STANDARD BALL VALVE LOCKOUT

Part No.	Description
LS3476	Size: 82mm x 55mm, hole diameter: 10mm
LS3477	Size: 157mm x 102mm, hole diameter: 10mm
LS3478	Size: 157mm x 102mm, hole diameter: 7.5mm

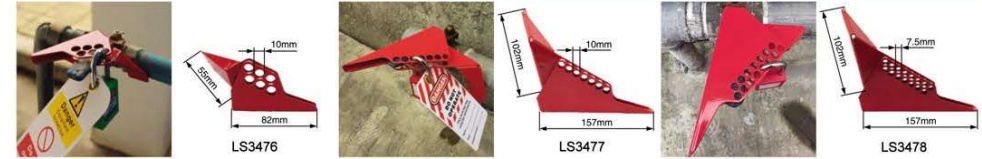

- Made from hardened steel, surface treatment by high temperature spraying, rust proof.
- The single-piece design locks can quarter-turn ball valves in off position.
- Used on ball valve sizes from 6.35mm (1/4") to 25mm (1"), hole diameter is 3/8".

Part No.	Description
L4800	Suitable for valve handle 1" to 6 1/2" in diameter

ADJUSTABLE GATE VALVE LOCKOUT

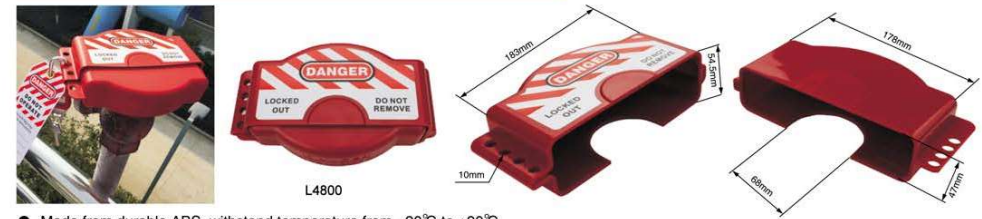

- Made from durable ABS, withstand temperature from -20°C to +90°C.
- Can be equipped together with padlocks. Padlock locking shackle max diameter 3/8"(10mm).
- Can be covered and rotated freely around valve wheel, and adjustable to fit a range of valve handles.

STANDARD GATE VALVE LOCKOUT

Part No.	Description	A	B	C	φ D
L480	Suitable for valve handle 1" to 2 1/2" in diameter	78	29	18	8
L481	Suitable for valve handle 2 1/2" to 5" in diameter	132	40	39	7.5
L482	Suitable for valve handle 5" to 6 1/2" in diameter	170	52	63	7.5
L483	Suitable for valve handle 6 1/2" to 10" in diameter	255	61	85	7.5
L484	Suitable for valve handle 10" to 13" in diameter	360	77	97	8
L485	Suitable for valve handle 13" to 18" in diameter	457	70	123	7.5
L486	Suitable for valve handle 18" to 25" in diameter	645	60	140	7.5

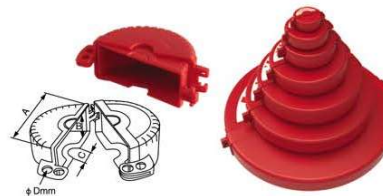

- Made from durable ABS, withstand temperature from -20°C to +90°C, metal free.
- Once locked, it covers wholly around the hand wheel and prevent the valve wheel from being turned.
- Two parts design can be combined into one when storing and carrying which reduce the half restore space.
- Accept up to 2 padlocks, locking shackle max diameter 7.5mm.
- Available in 7 sizes and red color, other colors can be customized, providing English tag.

STANDARD GATE VALVE LOCKOUT

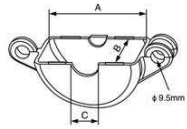

Part No.	Description	A	B	C
LS480	Suitable for valve handle 1" to 2 1/2" in diameter	72	30	19
LS481	Suitable for valve handle 2 1/2" to 5" in diameter	132	37	45
LS482	Suitable for valve handle 5" to 6 1/2" in diameter	174	44	63
LS484	Suitable for valve handle 6 1/2" to 10" in diameter	269	67	89
LS485	Suitable for valve handle 10" to 13" in diameter	355	66	105

- Made from durable ABS, withstand temperature from -20°C to +90°C.
- Once locked, it covers around the hand wheel and prevent the valve wheel from being turned.
- Accept up to 1 padlock, locking shackle max diameter 9.5mm.
- Available in 5 sizes and red color, other colors can be customized, providing English tag.
- Transparent one can be customized with PC.
- Part no.: NT-G01TR~ NT-G03TR.

Part No.	Description	A	B	C
L480B	25mm-64mm (1"-2.5")	70	28	18
L481B	64mm-127mm (2.5"-5")	132	36	44
L482B	127mm-165mm (5"-6.5")	172	40	63
L483B	165mm-254mm (6.5"-10")	269	60	88
L484B	254mm-330mm (10"-13")	359	60	105
L485B	330mm-475mm (13"-18")	475	67	105

STANDARD GATE VALVE LOCKOUT



- Made from Engineering plastic nylon ABS.
- Once locked, it covers around the hand wheel and prevent the valve wheel from being turned.
- Accept up 1 padlock, locking shackle max. diameter 9.5mm.

ROTATING GATE VALVE LOCKOUT

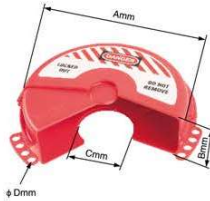

Part No.	Description	A	B	C	φ D
L480ML	Applicable stem diameter: 25mm-64mm	77	28	18	8.5
L481ML	Applicable stem diameter: 50mm-127mm	130	38	40	8.5
L482ML	Applicable stem diameter: 101mm-165mm	172	49	65	8.5
L483ML	Applicable stem diameter: 152mm-254mm	257	60	87	8.5
L484ML	Applicable stem diameter: 203mm-330mm	358	70	97	8.5
L485ML	5 size one set				



- Manufactured from ABS, lightweight dielectric thermoplastic.
- Outward / Inward rotation allows for easier installation & storage.
- Surrounds the valve handwheel to protect against accidental operation.
- 5 sizes available, each size nests within the next larger size for easy storage.
- Supplied with "Do Not Operate" warning message.

UNIVERSAL GATE VALVE LOCKOUT



Part No.	Description
LBF04	Max handle width 15mm
LBF04S	Max handle width 28mm
LBF04P	Max handle width 52mm



- Made from industrial grade steel and nylon, withstand temperature from -20°C to +140°C.
- Enable to lock out different types of butterfly valve with the base clamp.
- No other device offers such flexibility and security.
- Designed to handle extra impact and resist chemicals making them ideal for just about any environment.
- Can be matched with different fittings to make a series of universal valves.

Part No.	Description
LBF01S	Small lockout for handle width up to 15mm, with 1 arm
LBF01	Handle width up to 24mm, with 1 arm—For quarter—turn ball valves
LBF01P	Large lockout for handle width up to 52mm, with 1 arm
LBF02S	Small lockout for handle width up to 15mm, with 2 arms
LBF02	Handle width up to 24mm, with 2 arms—For 3,4 or 5-way valves, or to lock valves in the "on", "off" or "throttled" position
LBF02P	Large lockout for handle width up to 52mm, with 2 arms
LBF03S	Small lockout for handle width up to 15mm, with coated cable
LBF03	Handle width up to 24mm, with coated cable—For gate valves
LBF03P	Large lockout for handle width up to 52mm, with coated cable
LBF05S	Small lockout for handle width up to 15mm, with 1 arm & coated cable
LBF05	Handle width up to 24mm, with 1 arm & coated cable—Universal valve lockout for most valves
LBF05P	Large lockout for handle width up to 52mm, with 1 arm & coated cable

UNIVERSAL GATE VALVE LOCKOUT

- Made from industrial grade steel and nylon, withstand temperature from -20°C to +140°C.
- Enables to lock out valves of different types and sizes, such as large levers of valves, T—handles and other hard—to—secure mechanical devices.
- No other device offers such flexibility and security.
- Designed to handle extra impact and resist chemicals making them ideal for just about any environment.

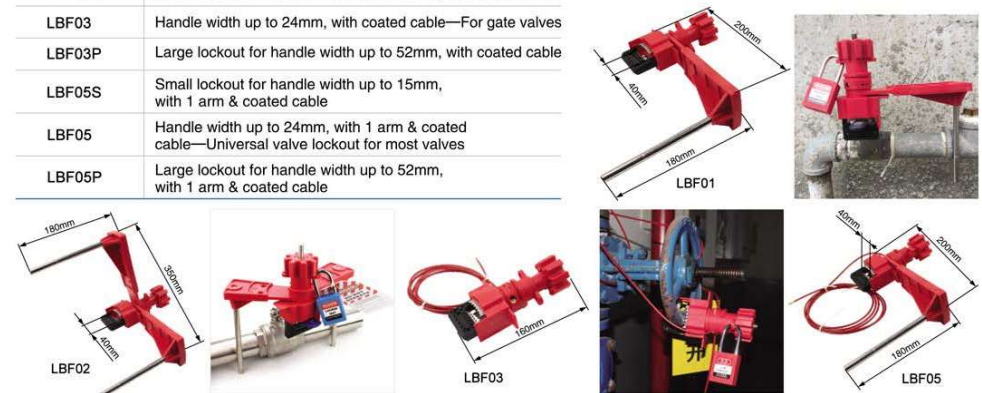

BLOCKING ARM

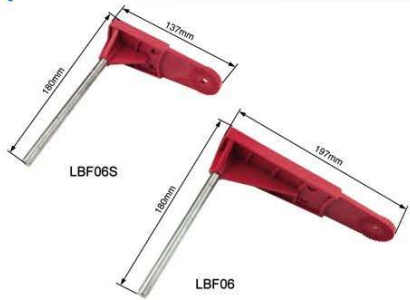

Part No.	Description
LBF06S	Size: 137mm(L)
LBF06	Size: 197mm(L)

- Made from industrial grade steel and nylon, withstand temperature from -20°C to +120°C.
- Used with universal valve lockout base.

Part No.	Description
LS3921	Suitable for valve handle from 8mm to 45mm



- Made from ABS, withstand temperature from -20°C to +90°C.
- Good chemical property, resistant to oil stains and chemical product corrosion.

BUTTERFLY VALVE LOCKOUT

- Can be covered and rotated freely around valve wheels and adjustable to fit all ranges of valve handles.

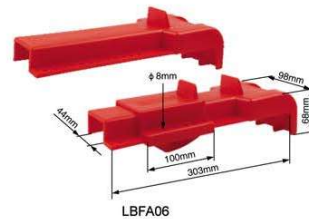

ADJUSTABLE BUTTERFLY VALVE LOCKOUT

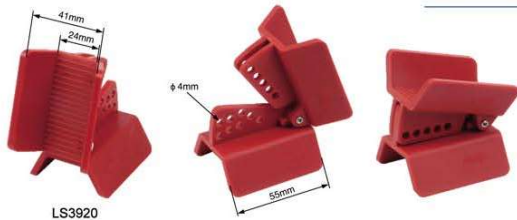

- Locks out valve in seconds by feeding NTC01-4 cable lockout device through desired eyelet and around valve neck.
- Made from nylon PA. Durable, lightweight thermoplastic material is chemical resistant and performs effectively in extreme environments.

Part No.	Description
LS3920	Adjustable angle: 15-36.

- Directional application arrows allow for ease of installation and minimize user error.
- Stainless steel rivet allows device to smoothly pivot open and closed to ensure proper fit.



ADJUSTABLE FLANGED BALL VALVE LOCKOUT

Part No.	Description
L4800	Suitable for 6.35mm(1/4") to 140mm(5") flanged ball valves

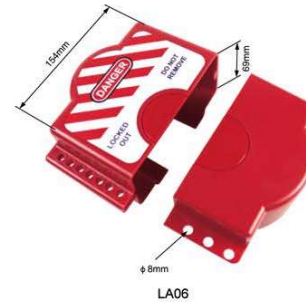

- Made from durable ABS, withstand temperature from -20°C to +90°C.
- Accept up to 1 padlock, locking shackle max diameter 8mm.
- Available in red color, other colors can be customized, providing English tags.

Part No.	Description
L468L	Suitable for valve diameter under 22mm(0.87")



- Made from PC, PU and PVC.
- Easy to carry and operate, use the belt to fix the lockout bag.
- Fine tailoring, smooth surface, excellent workmanship.
- Fits virtually all types of pipe including insulated, PVC and metal.

ADJUSTABLE BALL SAFETY VALVE LOCKOUT



- Most 4pcs padlocks can lock on at the same time. Suitable for multiple people or work groups.
- Universal fit—effectively locks out all valves from 3/8in (10mm) to 4in (102mm).

PLUG VALVE LOCKOUT

Part No.	Description
LF41	Suitable for valve diameter under 22mm(0.87") size: 79 x 79 x 84mm
LF42	Suitable for valve diameter from 23mm(0.9") to 34.9mm(1.37") size: 93 x 93 x 98mm
LF43	Suitable for valve diameter from 44mm(1.73") to 53.9mm(2.12") size: 98 x 98 x 105mm
LF44	Suitable for valve diameter from 55mm(2.17") to 63.5mm(2.5") size: 116 x 116 x 112mm



Measure the diameter of the valve (from A to B) and then choose suitable valve lockout.

- Four size available, suitable for valve diameter from 25.4 mm(1") to 203.2 mm(8")
- Durable and vandal resistant.
- Small size, easy to be carried.
- Choose the right plug valve lockout by measuring the size of A and B.



BUTTERFLY VALVE LOCKOUT

Part No.	Description
LSBV31	Hole diameter: 8mm



- Made of durable ABS plastic.
- Exclusive, anti-pivot lockout device fits the full range of pull handle valve sizes, from 1/2 in. to 8 in. diameter.
- A convenient, one-piece design that stays together whether in use or in storage.
- Holds up to three worker padlocks.
- Effective for all popular pull handle valves commonly used in food and beverage, water utilities, chemical, pharmaceutical and many other industries.
- Secures the valve handle in any desired position, from fully closed, to partially or fully open.

Part No.	Description
LS2251	Hole diameter: 32mm, 46mm
LS2252	Hole diameter: 24.5mm



CUSTOMIZED VALVE LOCKOUT

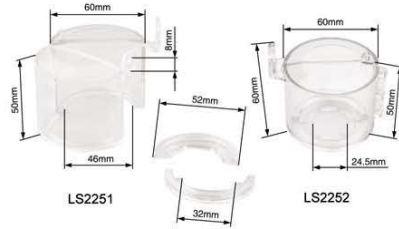

- Made of transparent PC, withstand temperature from -20°C to +120°C.
- Once locked, prevent the valve from being turned.
- The base allows use with two semicircles to accommodate valve.
- Accommodates valve up to 55mm diameter and 43mm tall.
- Fits 24.5mm and 32mm-46mm diameter valve.

CUSTOMIZED VALVE LOCKOUT

Part No.	Description
LS2253	Hole diameter: 8mm

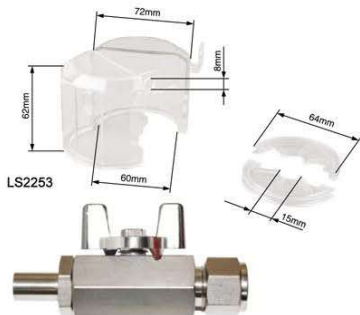

- Made of transparent PC, withstand temperature from -20°C to +120°C.
- Prevent the valve handles from being turned when locked out.
- Using the two semicircles to accommodate double lock valves.
- Accommodates buttons up to 60mm tall.

CUSTOMIZED VALVE LOCKOUT

Part No.	Description
LS2254	Hole diameter: 31.9mm x 31.9mm
LS2255	Hole diameter: 40mm x 40mm

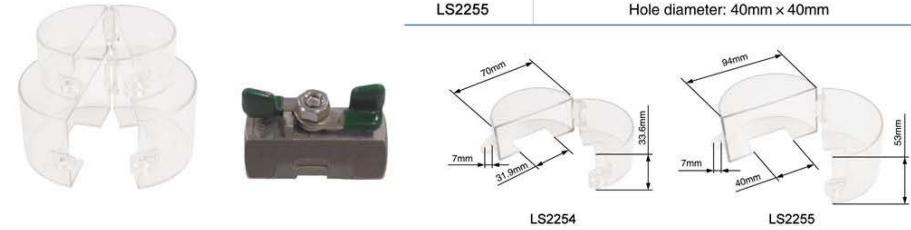

- Made of transparent PC, withstand temperature from -20°C to +120°C.
- Prevent the valve handles from being turned when locked out.
- Buckle directly to lock.
- NT-SB11 can accommodate inner valve up to 65mm diameter and 29mm tall. NT-SB12 can accommodate inner valve up to 89mm diameter and 49mm tall.
- NT-SB11 can accommodate outer valve up to 70mm diameter and 33.6mm tall. NT-SB12 can accommodate outer valve up to 91mm diameter and 53mm tall.

Part No.	Description
LS2256	Hole diameter: 24.5mm
LS2257	Hole diameter: 32mm

CUSTOMIZED VALVE LOCKOUT

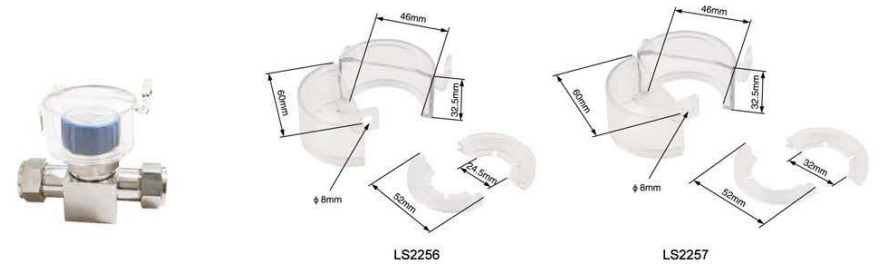

- Made of transparent PC, withstand temperature from -20°C to +120°C.
- Once locked, prevent the valve from being turned.
- The base allows use with two semicircles to accommodate valve.
- Fits 24.5mm and 32mm-46mm diameter valve.