



Datasheet

ENGLISH

Stock No: 126-3937

RS Pro Cylindrical Male - Male Anti-Vibration Mounts



Line Drawing:

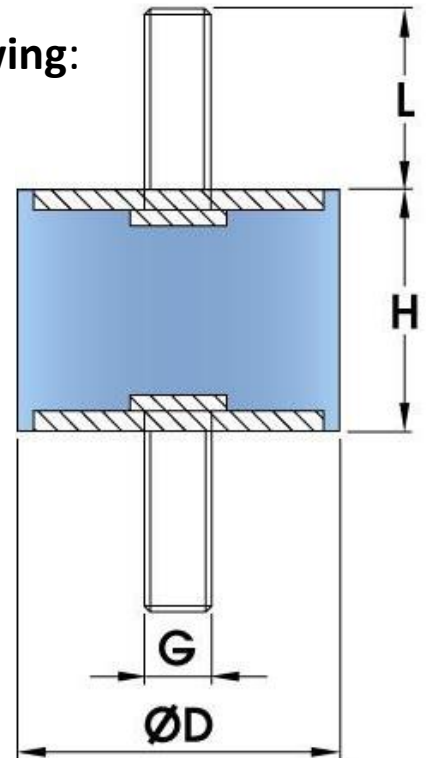

Product Details

Male – Male Cylindrical Mounts:

A Simple And Cost effective mount. For use in compression and shear. A Very large range of available size and studs.

H – Height

D – Diameter

G – Tread Size

L – Stud Length

Range Table:

RS Stock Number	Description	D	H	G x L	Load	Sheer	Load2	Sheer2
126-3910	Cyl. Mount (M/M) 10x8mm M5x15	10	8	M5x15	6	2	13.3	5.2
1263911	Cyl. Mount (M/M) 20x15mm M8x23 Stainless Steel (304 grade)	20	15	M8x20	12.3	4.2	25.5	9.2
1263912	Cyl. Mount (M/M) 30x20mm M8x20 Stainless Steel (316 grade)	30	22	M8x20	27	9.5	57	20.8
1263913	Cyl. Mount (M/M) 40x30mm M10x25 Stainless Steel (304 grade)	40	30	M10x25	48.1	17	100.2	36.9
1263914	Cyl. Mount (M/M) 50x40mm M10x28 EPDM Stainless Steel (316 grade)	50	40	M10x28	73	25.6	153.3	57.7
1263915	Cyl. Mount (M/M) 75x40mm M12x40 Stainless Steel (316 grade)	75	40	M12x37	203.2	59.6	403	129.9
1263916	Cyl. Mount (M/F) 10x15mm M5x8 EPDM Stainless Steel (304 grade)	10	15	M5x8	1.75	0.6	4.1	1.4
126-3935	Cyl. Mount (M/M) 8x8 M3x6	8	8	M3x6	2.4	0.8	4.4	1.5
126-3936	Cyl. Mount (M/M) 8x8 M3x6	8	8	M3x6	2.4	0.8	4.4	1.5
126-3937	Cyl. Mount (M/M) 100x100 M12x37	100	100	M16x46	250	106	400.6	230.9
126-3938	Cyl. Mount (M/M) 100x50 M16x46	100	50	M16x46	357.7	106	740	230.9
126-3939	Cyl. Mount (M/M) 10x8mm M4x10	10	8	M4x10	9.2	4	15.1	5.2
126-3940	Cyl. Mount (M/M) 12.5x20mm M5x12	12.5	20	M5x12	6	2	13.3	5.2
126-3941	Cyl. Mount (M/M) 15x10 M4x15	15	10	M4x15	9.2	4	15.1	5.2
126-3942	Cyl. Mount (M/M) 15x30 M5x15	15	30	M5x15	1.75	0.6	4.1	1.4
126-3943	Cyl. Mount (M/M) 16x10 M5x10	16	10	M5x10	15	6	30	12
126-3944	Cyl. Mount (M/M) 16x18 M4x15	16	18	M4x15	6	2	13.3	5.2
126-3945	Cyl. Mount (M/M) 16x18 M5x15	16	18	M5x15	6	2	13.3	5.2
126-3946	Cyl. Mount (M/M) 16x18mm M5x15	16	18	M5x15	6	2	13.3	5.2
126-3947	Cyl. Mount (M/M) 18x8.5mm M6x15	18	8.5	M6x15	6	2	13.3	5.2
126-3948	Cyl. Mount (M/M) 20x15 M6x20	20	15	M6x20	12.3	4.2	25.5	9.2
1263949	Cyl. Mount (M/M) 20x20 M6x20	20	20	M6x20	11	4.2	23.5	9.2
1263950	Cyl. Mount (M/M) 20x20mm M6x18	20	20	M6x18	11	4.2	23.5	9.2
1263951	Cyl. Mount (M/M) 20x30 M6x20	20	30	M6x20	10.2	4.1	22.3	9
1263952	Cyl. Mount (M/M) 20x30mm M6x20	20	30	M6x20	10.2	4.1	22.3	9
1263953	Cyl. Mount (M/M) 25x10 M8x20	25	10	M8x20	33	6.6	60.3	14.4
1263954	Cyl. Mount (M/M) 25x15 M6x20	25	15	M6x20	21.5	6.6	43.2	14.4
1263955	Cyl. Mount (M/M) 25x15 M8x20	25	15	M8x20	21.5	6.6	43.2	14.4
1263956	Cyl. Mount (M/M) 25x20 M8x20	25	20	M8x20	18.4	6.6	38.5	14.4
1263957	Cyl. Mount (M/M) 25x25 M6x20	25	25	M6x20	17.1	6.6	36.6	14.4
1263958	Cyl. Mount (M/M) 25x25mm M6x20	25	25	M6x20	17.1	6.6	36.6	14.4
1263959	Cyl. Mount (M/M) 25x30 M6x20	25	30	M6x20	16.4	6.6	35.6	14.4
1263960	Cyl. Mount (M/M) 25x30 M8x20	25	30	M8x20	16.4	6.6	35.6	14.4
1263961	Cyl. Mount (M/M) 25x30 M8x20	25	30	M8x20	16.4	6.6	35.6	14.4
1263962	Cyl. Mount (M/M) 25x35mm M6x20	25	35	M6x20	16.4	6.6	35.6	14.4
1263963	Cyl. Mount (M/M) 30x15 M8x20	30	15	M8x20	37.8	9.5	72.3	20.8
1263964	Cyl. Mount (M/M) 30x20 M8x20	30	20	M8x20	29.5	9.5	60	20.8
1263965	Cyl. Mount (M/M) 30x22 M8x20	30	22	M8x20	27	9.5	57	20.8
1263966	Cyl. Mount (M/M) 30x22 M8x20	30	22	M8x20	27	9.5	57	20.8
1263967	Cyl. Mount (M/M) 30x30 M8x20	30	30	M8x20	24.8	9.5	52.9	20.8
1263968	Cyl. Mount (M/M) 30x30mm M8x25	30	30	M8x25	24.8	9.5	52.9	20.8
1263969	Cyl. Mount (M/M) 35x30mm M6x15	35	30	M6x15	24.8	9.5	52.9	20.8
1263970	Cyl. Mount (M/M) 40x20 M10x25	40	20	M10x25	63.2	17	122.6	36.9
1263971	Cyl. Mount (M/M) 40x25mm M10x25	40	28	M10x25	54	17	112	36.9
1263972	Cyl. Mount (M/M) 40x28 M10x25	40	28	M10x25	49.2	17	104	36.9
1263973	Cyl. Mount (M/M) 40x30 M10x25	40	30	M10x25	48.1	17	100.2	36.9
1263974	Cyl. Mount (M/M) 40x30 M8x23	40	30	M8x23	48.1	17	100.2	36.9
1263975	Cyl. Mount (M/M) 40x35 M8x23	40	35	M8x23	46	17	97.8	36.9
1263976	Cyl. Mount (M/M) 40x40 M8x23	40	40	M8x23	43.7	17	93.5	36.9
1263977	Cyl. Mount (M/M) 40x40mm M8x23	40	40	M8x23	43.7	17	93.5	36.9
1263978	Cyl. Mount (M/M) 50x20 M10x25	50	20	M10x25	124.8	26.5	230.6	57.7
1263979	Cyl. Mount (M/M) 50x25 M10x25	50	25	M10x25	97.6	26.5	190	57.7
1263980	Cyl. Mount (M/M) 50x30 M10x25	50	30	M10x25	84.6	26.5	170.6	57.7
1263981	Cyl. Mount (M/M) 50x35 M10x25	50	35	M10x25	77.4	26.5	159.8	57.7
1263982	Cyl. Mount (M/M) 50x40 M10x25	50	40	M10x25	73	26.5	153.3	57.7
1263983	Cyl. Mount (M/M) 50x42 M12x37	50	42	M12x37	71.5	26.5	151.1	57.7
1263984	Cyl. Mount (M/M) 50x45 M10x25	50	45	M10x25	70.1	26.5	149	57.7
1264268	Cyl. Mount (M/M) 60x25 M10x25	60	25	M10x25	152.5	30	283.8	68
1264269	Cyl. Mount (M/M) 60x35 M10x25	60	35	M10x25	123.7	30	229.8	68
1264270	Cyl. Mount (M/M) 70x35 M12x37	70	35	M12x37	189.6	40	391.1	80
1264271	Cyl. Mount (M/M) 70x50 M10x25	70	50	M10x25	142.3	40	292.7	80
1264272	Cyl. Mount (M/M) 75x50 M12x37	75	50	M12x37	176.6	59.6	363.2	129.9