

# Phase Control Thyristor

**multicomp** PRO

**RoHS  
Compliant**

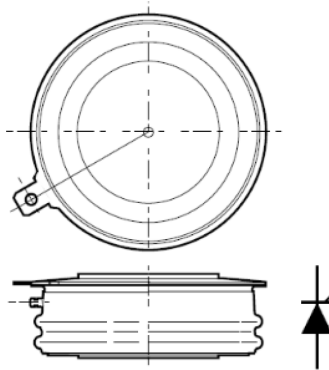

Outline type code: E

## Features

- Double Side Cooling
- High Surge Capability

## Applications

- High Power Drives
- High Voltage Power Supplies
- Static Switches

## Key Parameters

Part Number	Repetitive Peak Voltages $V_{DRM}$ and $V_{RRM}$ V	$I_{T(AV)}$	$I_{TSM}$	$dV/dt^*$	$dI/dt$	Conditions
MPPCT720E180	1800	720 A	8300 A	1000 V/ $\mu$ s	200 A/ $\mu$ s	$T_{vj} = -40^{\circ}\text{C}$ to $125^{\circ}\text{C}$ , $I_{DRM} = I_{RRM} = 30\text{mA}$ , $V_{DRM}, V_{RRM} t_p = 10\text{ms}$ , $V_{DSM} \& V_{RSM} =$ $V_{DRM} \& V_{RRM} + 100\text{V}$ respectively

\* Higher  $dV/dt$  selections are available

## Current Ratings

$T_{case} = 60^{\circ}\text{C}$  unless stated otherwise

Symbol	Parameter	Test Conditions	Max.	Units
$I_{T(AV)}$	Mean on-state current	Half wave resistive load	720	A
$I_{T(RMS)}$	RMS value	-	1230	
$I_T$	Continuous (direct) on-state current	-	970	

## Surge Ratings

Symbol	Parameter	Test Conditions	Max.	Units
$I_{TSM}$	Surge (non-repetitive) on-state current	10ms half sine, $T_{case} = 125^{\circ}\text{C}$ $V_R = 0$	8.3	kA
$I^2t$	$I^2t$ for fusing		0.344	$\text{MA}^2\text{s}$

Newark.com/multicomp-pro  
Farnell.com/multicomp-pro  
Element14.com/multicomp-pro

**multicomp** PRO

## Thermal and Mechanical Ratings

Symbol	Parameter	Test Conditions	Min.	Max.	Units
$R_{th(j-c)}$	Thermal resistance – junction to case	Double side cooled DC	-	0.041	°C/W
$R_{th(c-h)}$	Thermal resistance – case to heatsink			0.01	
$T_{vj}$	Virtual junction temperature	Blocking $V_{DRM} / V_{RRM}$		125	°C
$T_{stg}$	Storage temperature range		-40	140	
$F_m$	Clamping force		4	6	kN

## Dynamic Characteristics

Symbol	Parameter	Test Conditions	Min.	Max.	Units
$I_{RRM}/I_{DRM}$	Peak reverse and off-state current	At $V_{RRM}/V_{DRM}$ , $T_{case} = 125^\circ\text{C}$		30	mA
$dV/dt$	Max. linear rate of rise of off-state voltage	To 67% $V_{DRM}$ , $T_j = 125^\circ\text{C}$ , gate open		1000	V/ $\mu\text{s}$
$di/dt$	Rate of rise of on-state current	From 67% $V_{DRM}$ to 1000A	-	-	A/ $\mu\text{s}$
		Gate source 30V, 10 $\Omega$ , $t_r < 0.5\mu\text{s}$ , $T_j = 125^\circ\text{C}$			
		Repetitive 50Hz			200
		Non-repetitive			1000
$V_T$	On-state voltage	$I_T = 1500\text{A}$ , $T_{case} = 125^\circ\text{C}$		1.97	V
$V_{T(TO)}$	Threshold voltage	$T_{case} = 125^\circ\text{C}$		1.09	
$r_T$	On-state slope resistance	$T_{case} = 125^\circ\text{C}$		0.587	m $\Omega$
$t_{gd}$	Delay time	$V_D = 67\% V_{DRM}$ , gate source 30V, 10 $\Omega$ $t_r = 0.5\mu\text{s}$ , $T_j = 25^\circ\text{C}$		3	$\mu\text{s}$
$t_q$	Turn-off time	$T_j = 125^\circ\text{C}$ , $V_R = 100\text{V}$ , $di/dt = 10\text{A}/\mu\text{s}$ , $dV_{DR}/dt = 20\text{V}/\mu\text{s}$ linear to 67% $V_{DRM}$		150	
$Q_s$	Stored charge	$I_T = 1000\text{A}$ , $T_j = 125^\circ\text{C}$ , $di/dt = 10\text{A}/\mu\text{s}$ , $t_p = 1000\mu\text{s}$		1500	$\mu\text{C}$
$I_{RR}$	Reverse recovery current			110	A
$I_L$	Latching current	$T_j = 25^\circ\text{C}$ ,		1	
$I_H$	Holding current	$T_j = 25^\circ\text{C}$ ,		200	mA

## Gate Trigger Characteristics and Ratings

Symbol	Parameter	Test Conditions	Max.	Units
$V_{GT}$	Gate trigger voltage	$V_{DRM} = 5\text{V}$ , $T_{case} = 25^\circ\text{C}$	3	V
$V_{GD}$	Gate non-trigger voltage	At 40% $V_{DRM}$ , $T_{case} = 125^\circ\text{C}$	0.3	
$I_{GT}$	Gate trigger current	$V_{DRM} = 5\text{V}$ , $T_{case} = 25^\circ\text{C}$	300	mA
$I_{GD}$	Gate non-trigger current	At 40% $V_{DRM}$ , $T_{case} = 125^\circ\text{C}$	20	

## Performance Curves

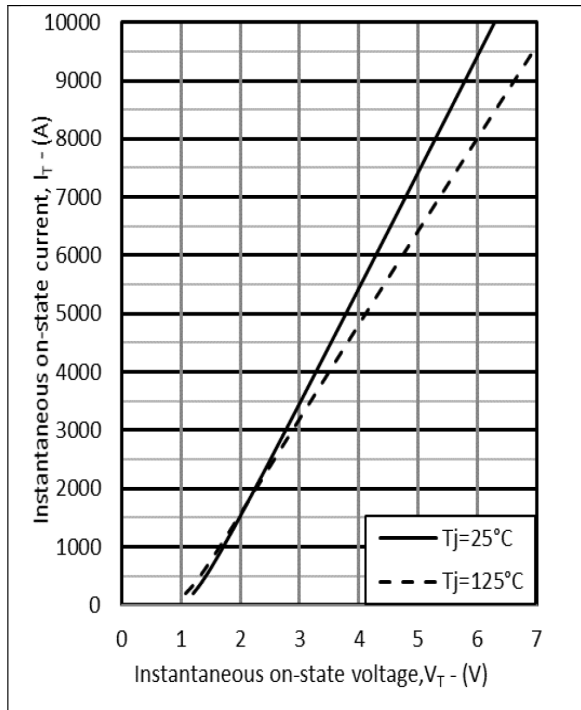

### $V_{TM}$ EQUATION

$$V_{TM} = A + B \cdot \ln(I_T) + C \cdot I_T + D \cdot \sqrt{I_T}$$

Where

- A = 0.213846
- B = 0.177258
- C = 0.000692251
- D = -0.0152068

These values are valid for  $T_j = 125^\circ\text{C}$

Fig. 2 Maximum on state characteristics

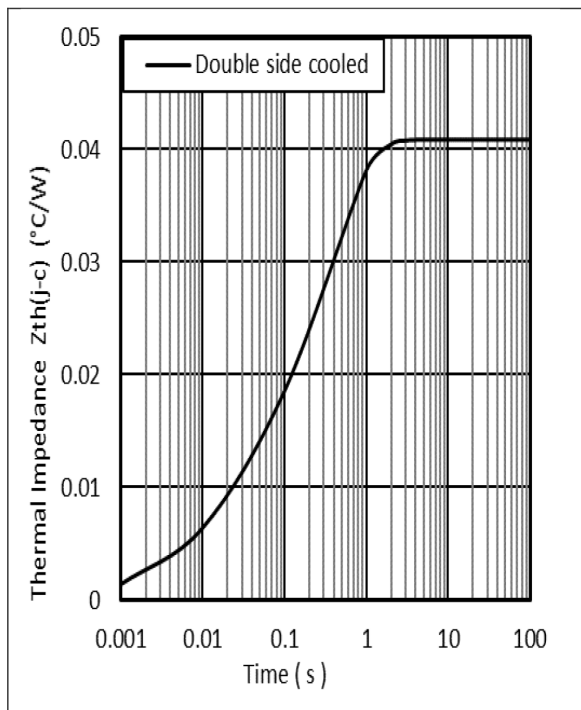

$$R_{thjc}(t) = \sum_{i=1}^n R_{thi} \cdot \left( 1 - e^{-\frac{t}{\tau_i}} \right)$$

i	$\tau_i$ (s)	$R_{thi}$ (°C/kW)
1	0.5391689	16.5
2	0.1940576	14.19235
3	0.0219527	7.412673
4	0.0021962	2.759765

Fig. 3 Maximum (limit) transient thermal impedance - junction to case (°C/W)

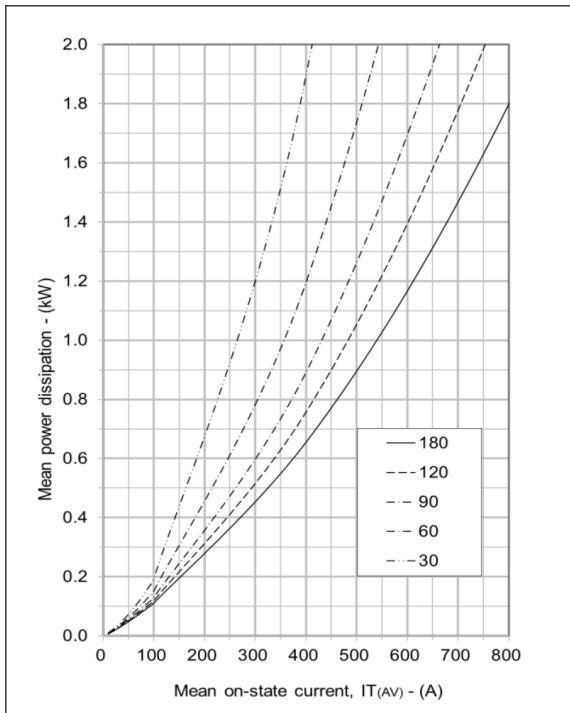

Fig. 4 On-state power dissipation - sine wave

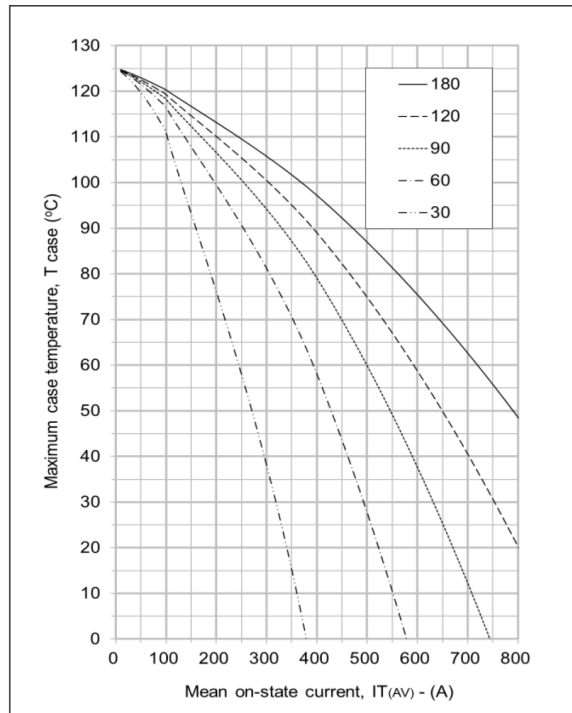

Fig. 5 Maximum permissible case temperature, double side cooled - sine wave

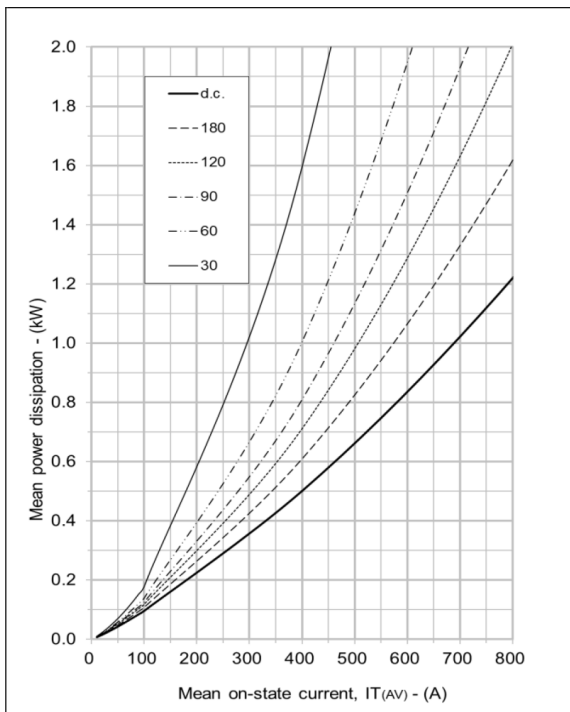

Fig. 6 On-state power dissipation - rectangular wave

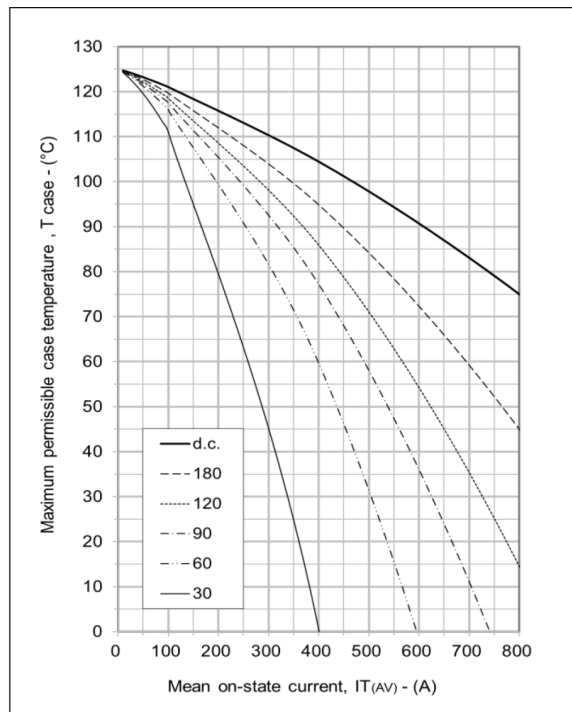

Fig. 7 Maximum permissible case temperature, double side cooled - rectangular wave

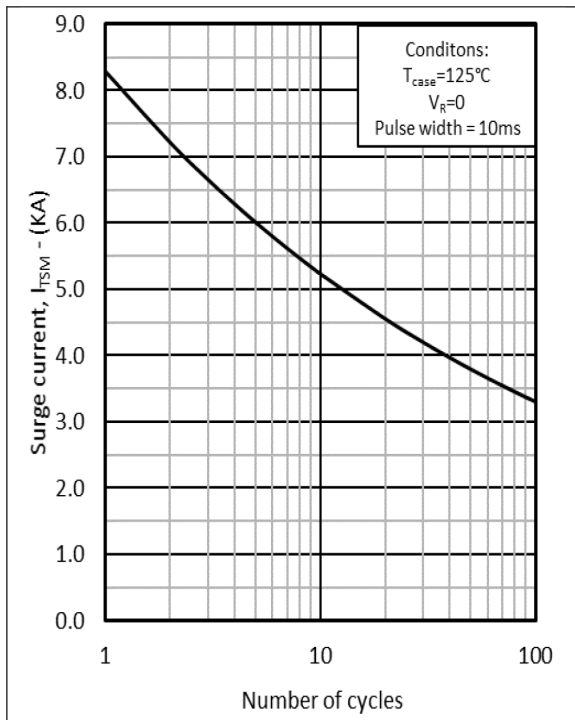

Fig. 8 Multi-cycle surge current

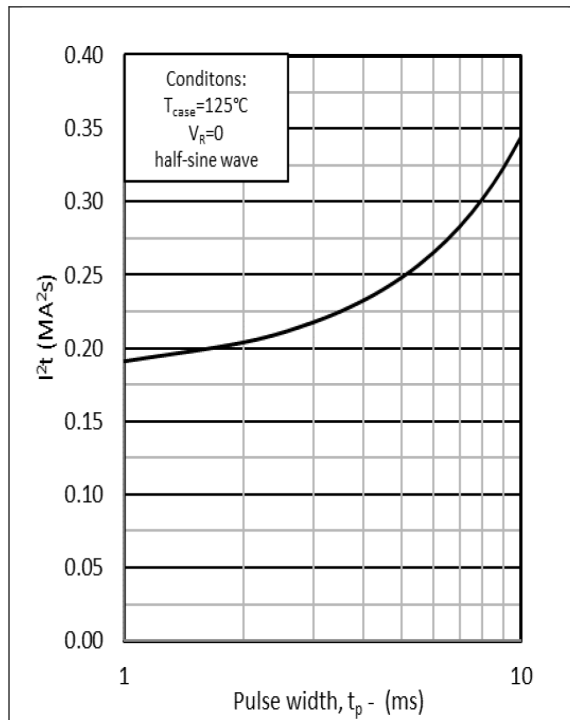

Fig. 9 Single-cycle  $I^2t$

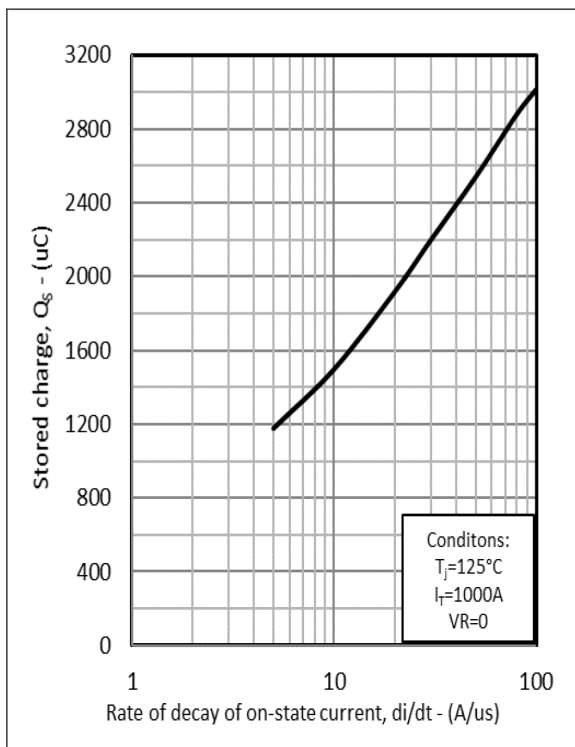

Fig. 10 Reverse recovery charge

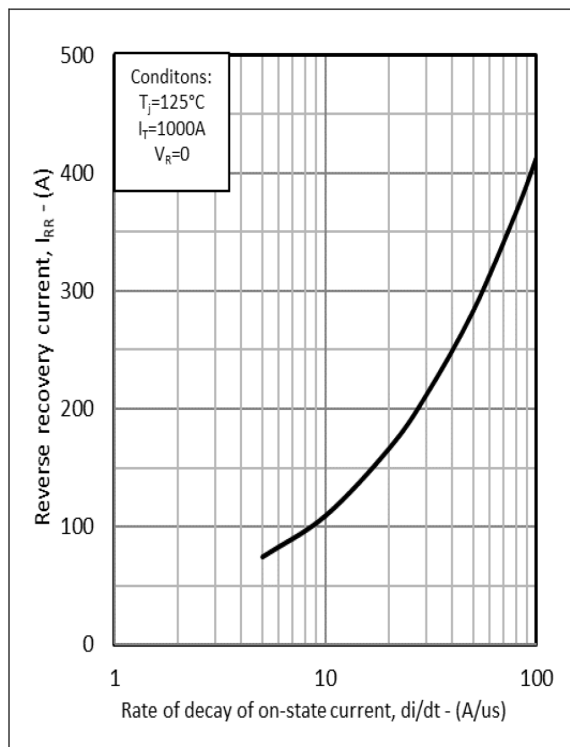

Fig. 11 Reverse recovery current

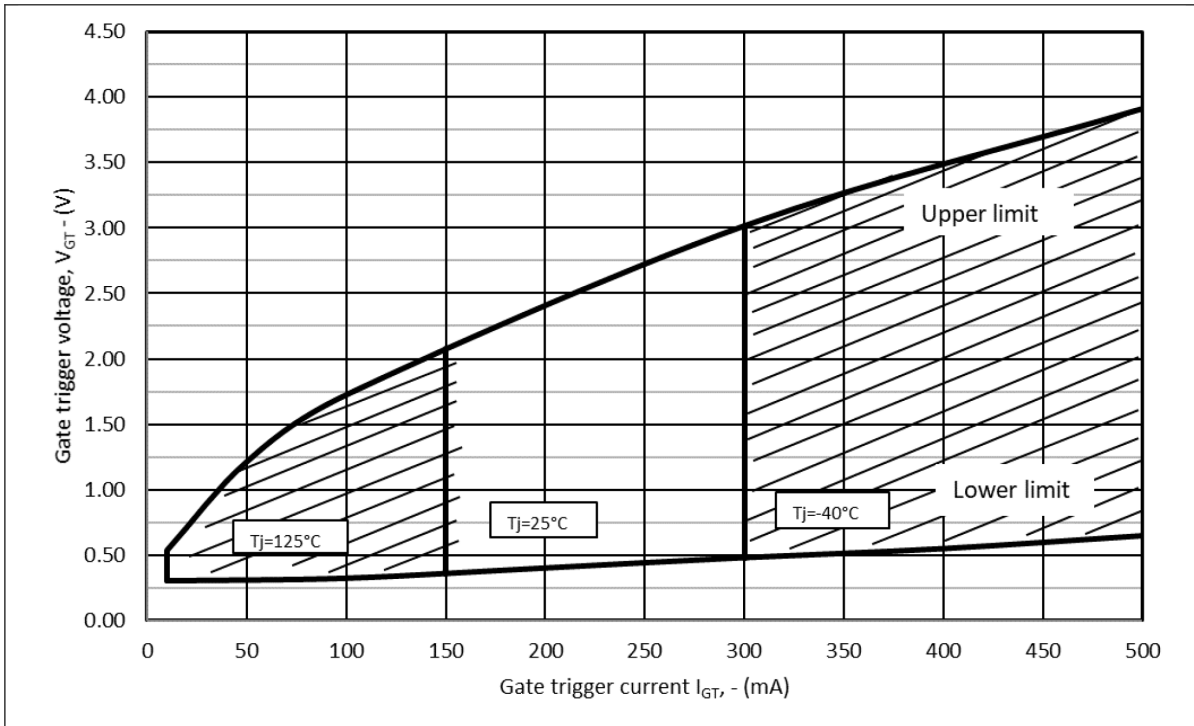

Fig. 12 Gate characteristics

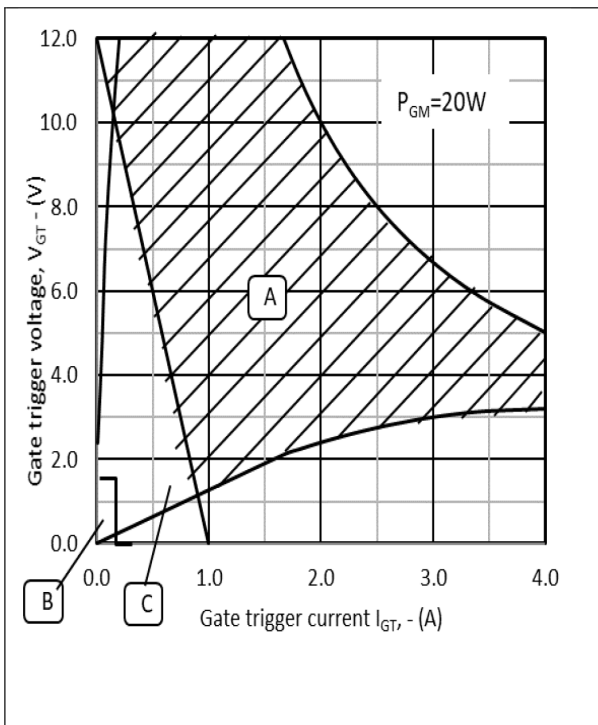
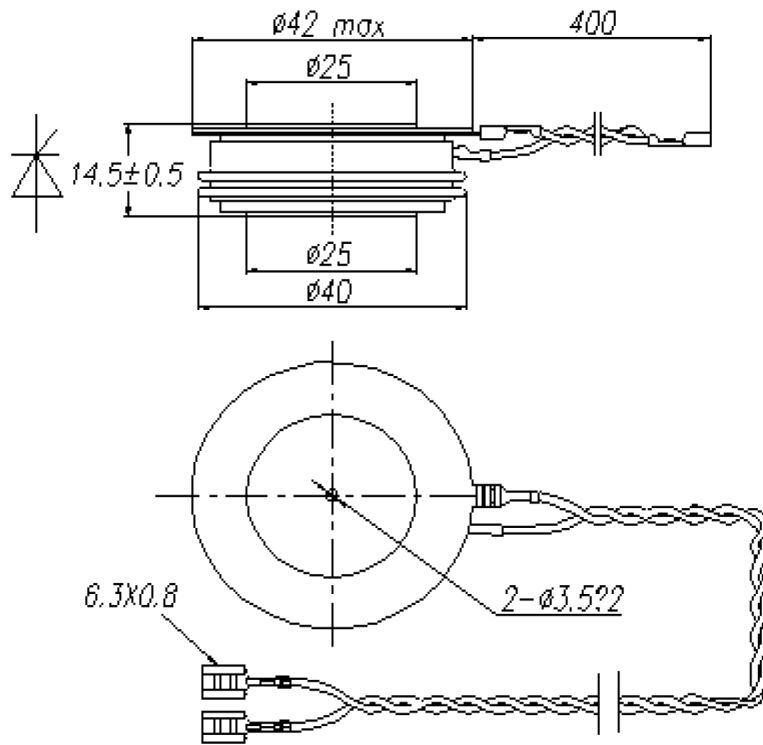

Fig. 13 Gate characteristics

- A: is Recommended Triggering Area.
- B: is Unreliable Triggering Area.
- C: is Recommended Gate Load Line.

# Phase Control Thyristor

**multicomp**PRO



Package outline type code: E

## Part Number Table

Description	Part Number
Phase Control Thyristor Module, 1800V, 720A, E Case Code	MPPCT720E180

**Important Notice :** This data sheet and its contents (the "Information") belong to the members of the AVNET group of companies (the "Group") or are licensed to it. No licence is granted for the use of it other than for information purposes in connection with the products to which it relates. No licence of any intellectual property rights is granted. The Information is subject to change without notice and replaces all data sheets previously supplied. The Information supplied is believed to be accurate but the Group assumes no responsibility for its accuracy or completeness, any error in or omission from it or for any use made of it. Users of this data sheet should check for themselves the Information and the suitability of the products for their purpose and not make any assumptions based on information included or omitted. Liability for loss or damage resulting from any reliance on the Information or use of it (including liability resulting from negligence or where the Group was aware of the possibility of such loss or damage arising) is excluded. This will not operate to limit or restrict the Group's liability for death or personal injury resulting from its negligence. Multicomp Pro is the registered trademark of Premier Farnell Limited 2019.

Newark.com/multicomp-pro  
 Farnell.com/multicomp-pro  
 Element14.com/multicomp-pro

**multicomp**PRO