

# Datasheet

## 8 Pole Male Straight DIN Connector

RS Stock number [491-138](#)

Drawing (mm):

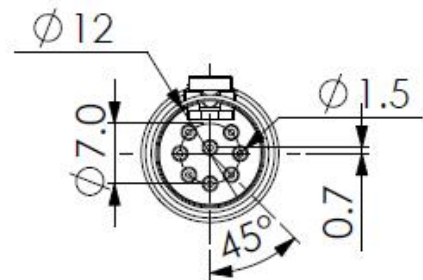
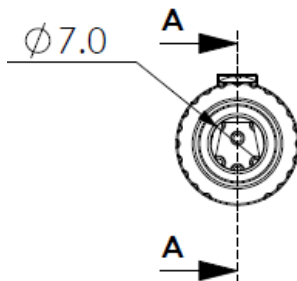
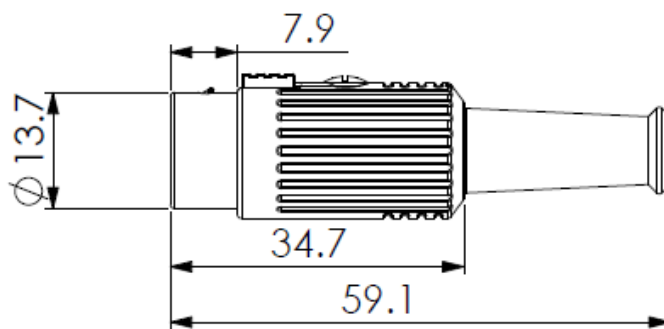

### Specifications:

rating :

100V AC 4A MAX

contact resistance :

pins-30mΩ MAX; shell-50mΩ MAX

insulation resistance :

MIN 100 MEGΩ @500V DC

voltage withstand :

250V AC R.M.S. for 1 minute

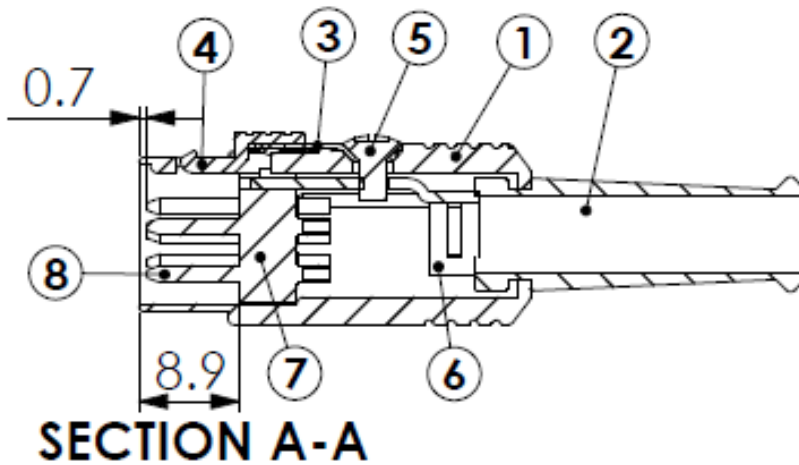

No.	Description	Material	Treat	Quantity
1	Shield Cover	Zn Alloy	Chrome Ptd.	1
2	Strain Boot	PVC		1
3	Leaf Spring	Steel	Thermal Treatment	1
4	Hook Button	Zn Alloy	Nickel Ptd.	1
5	Setscrew	Steel	Nickel Ptd.	1
6	'T' Holder	Steel	Nickel Ptd.	1
7	Housing	ABS		1
8	Terminals	Brass	Silver Ptd.	8