

FEATURES

- Wire is un-terminated and partially stripped
- Cable length is 2m
- Insulation Resistance $\geq 100 \text{ M}\Omega$
- Brass nickel plated coupling nut

RS PRO M12 FEMALE CONNECTOR ASSEMBLY 4 PIN 4 WIRE RIGHT ANGLE 2m 0.25 sq. mm PVC GREY CABLE

RS Stock No.: 2121703



RS Professionally Approved Products bring to you professional quality parts across all product categories. Our product range has been tested by engineers and provides a comparable quality to the leading brands without paying a premium price.

Product Description

ATTRIBUTE 1

M12 Single Ended Cable Assembly

Brought to you under the trusted RS Brand, this range of M12 connector cable assemblies are commonly used in sensor and automation equipment. Boasting a high degree of environmental protection, they are ideal for industrial use. Fitted with a secure coupling nut, these RS M12 Connector Cable Assemblies are left un-terminated and partially stripped at one end, and are an ideal solution for when secure and reliable data transference is needed.

Features and Benefits:

- Wire is un-terminated and partially stripped
- Insulation Resistance $\geq 100 \text{ M}\Omega$
- Neoprene O-Ring
- Brass nickel plated coupling nut

General Specifications

Rated Operational Voltage	250 V
Current Rating	4A
Insulation Resistance	$\geq 100 \text{ M}\Omega$
Temperature Range	-25°C ... +75°C
Coding	A-Coded

Material Specifications

Grip Material	PU
Contact	Cu-Zn
Contact Plating	Gold Flash
Contact Carrier	Nylon 66
O-Ring	Neoprene
Grip Color	Black
Coupling Nut	Brass Nickel-Plated

Cable Specifications

Cable Length-L	2 m
Cable Type	4 Core PVC Multi Strand
Sheath Color	Grey
Cross Section of Wire	0.25 sq. mm

RS PRO M12 SINGLE ENDED CABLE ASSEMBLY

Core Dia	1.25 mm
Cable Dia	4.8 ± 0.1 mm
Termination	Partially Stripped

Protection Category

Degree of Protection	IP67
----------------------	------

Additional Information

Custom Tariff Number	85369090
----------------------	----------

Approvals

Standards Met	
---------------	--

Similar Products

Stock No.	Brand	Product Name	Attribute 1	Attribute 2
877-1038	RS PRO	M12 Female Angled Connector 4 Pin 2m PVC Cable	Industrial Automation Cable Assemblies	Actuator/Sensor Cable
877-1040	RS PRO	M12 Female Angled Connector 4 Pin 5m PVC Cable	Industrial Automation Cable Assemblies	Actuator/Sensor Cable

Connection Diagrams / Assembly Diagrams / Illustrations / Accessories

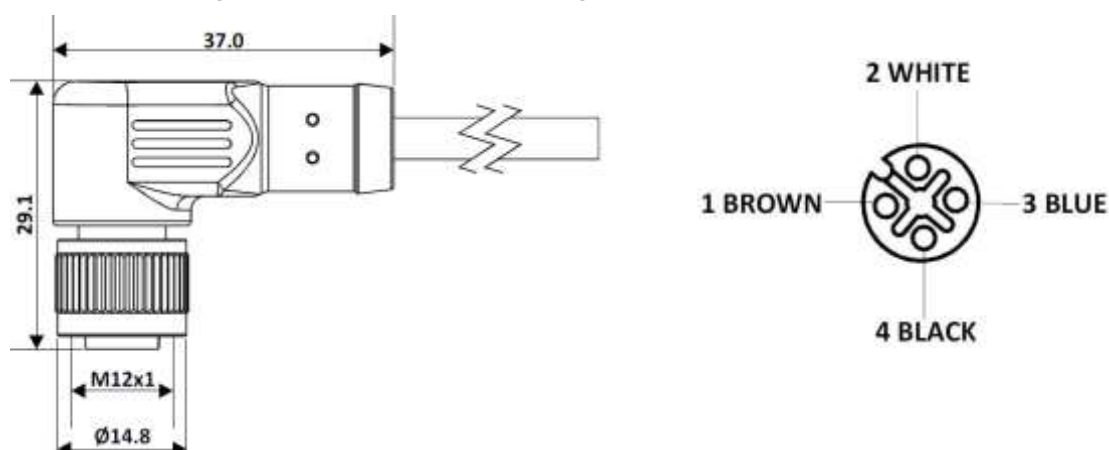

All Dimensions are in mm.