

FEATURES

- All fluids usable in aggressive environment
- Mechanical resistance
- Silicon free

RS PRO In Line Flow REG 316L F-F 1/4

RS Stock No.: 2312710



RS PROfessionally Approved Products bring to you professional quality parts across all product categories. Our product range has been tested by engineers and provides a comparable quality to the leading brands without paying a premium price.

Product Description

The RS PRO in line flow regulator 316L f-f 1/4 works in 0.2 bar to 25 bar pressure range. It is mainly used in chemical, petrochemical, life & sciences, inert gases and vacuum applications. It is also usable in salty environment and on machines that need frequent washing with aggressive detergents. RoHS and REACH compliant.

General Specifications

Type	Threaded
Application	Chemical, Petrochemical, Life & Sciences, Inert Gases And Vacuum Applications

Mechanical Specifications

Maximum Outlet Pressure	25bar
Length	36mm

Inlet Port	
Inlet Port Type	1/4 in Female
Tube Inlet Port	1/4 in Female

Outlet Port	
Tube Outlet Port	Flow Regulator

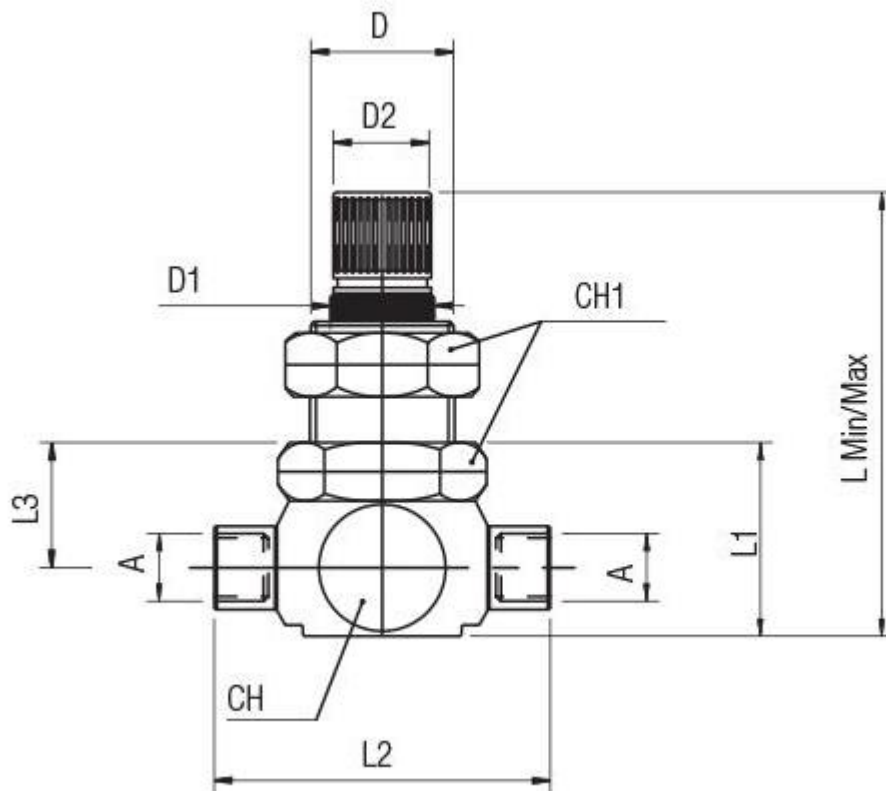

A	L Min/Max	L1	L2	L3	CH	CH1	D	D1	D2	Pack.
1/4	77/82	36	42	21.5	22	20	15	14	12	2